

US00D543892S

(12) **United States Design Patent**
Prechtl

(10) **Patent No.:** **US D543,892 S**

(45) **Date of Patent:** **** Jun. 5, 2007**

(54) **ARTIFICIAL GEMSTONE, NATURAL GEMSTONE ORNAMENTAL OBJECT MADE OF GLASS**

(75) Inventor: **Gerhard Prechtl**, Navis (AT)

(73) Assignee: **Swarovski Aktiengesellschaft**, Triesen (LI)

(**) Term: **14 Years**

(21) Appl. No.: **29/260,904**

(22) Filed: **Jun. 5, 2006**

(30) **Foreign Application Priority Data**

Dec. 7, 2005 (EM) 000444161-0006

(51) **LOC (8) Cl.** **11-02**

(52) **U.S. Cl.** **D11/90**

(58) **Field of Classification Search** D11/1-2, D11/26-29, 89-92; 63/26-28, 32

See application file for complete search history.

(56) **References Cited**

U.S. PATENT DOCUMENTS

D81,382 S * 6/1930 Dinhofer D11/90
D405,178 S * 2/1999 Dykes D24/146

D521,409 S * 5/2006 De Castro et al. D11/90
* cited by examiner

Primary Examiner—Ralf Seifert
(74) *Attorney, Agent, or Firm*—Wenderoth, Lind & Ponack, L.L.P.

(57) **CLAIM**

The ornamental design for a artificial gemstone, natural gemstone ornamental object made of glass, as shown and described.

DESCRIPTION

FIG. 1 is a left side view of a first embodiment of an artificial gemstone, natural gemstone, ornamental object made of glass according to the present design;

FIG. 2 is a front view according to the first embodiment;

FIG. 3 is a top view according to the first embodiment;

FIG. 4 is a back view according to the first embodiment;

FIG. 5 is a bottom view according to the first embodiment;

FIG. 6 is a right side view according to the first embodiment; and,

FIG. 7 is a perspective view according to the first embodiment.

1 Claim, 1 Drawing Sheet

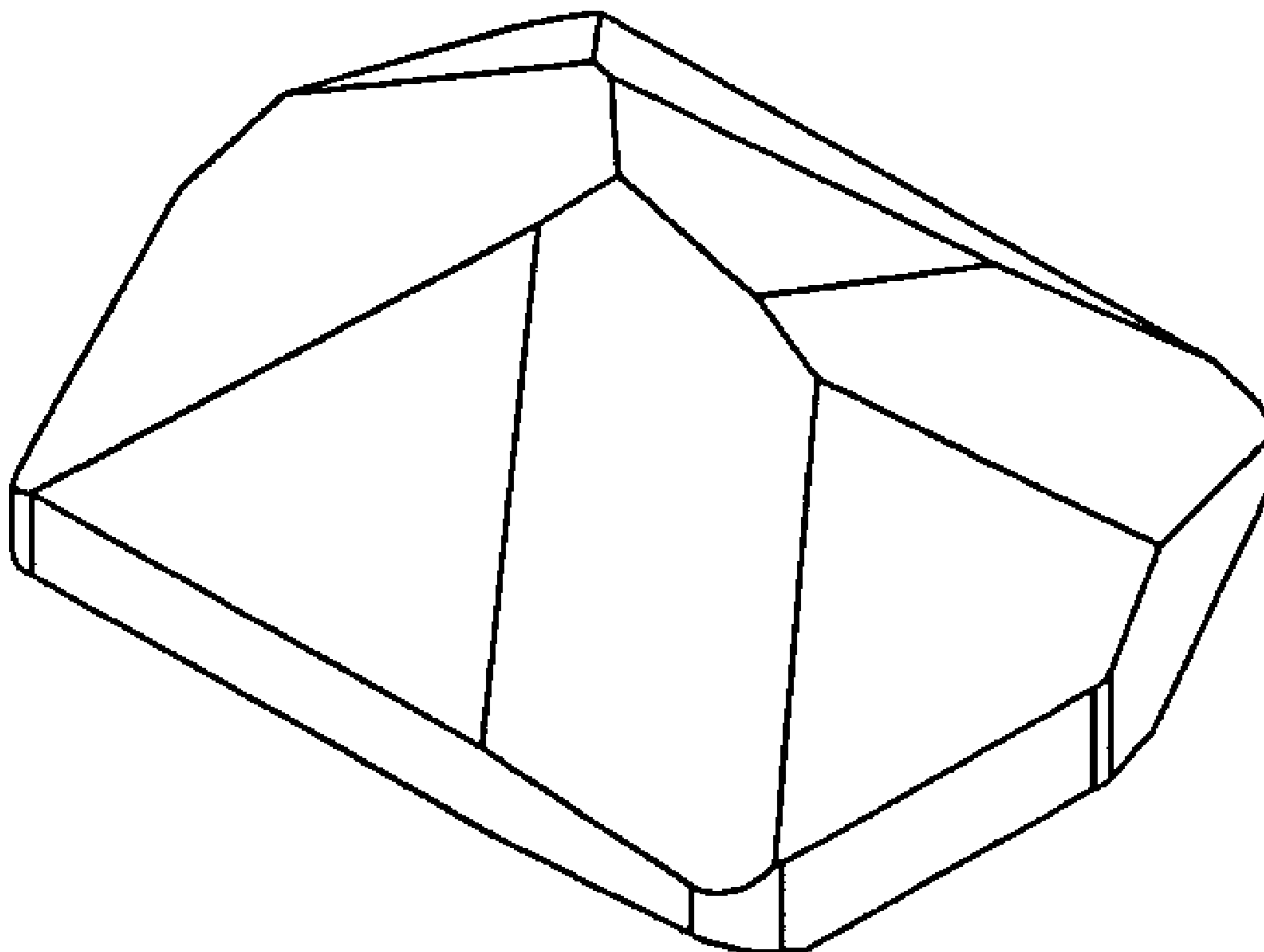

Fig. 1

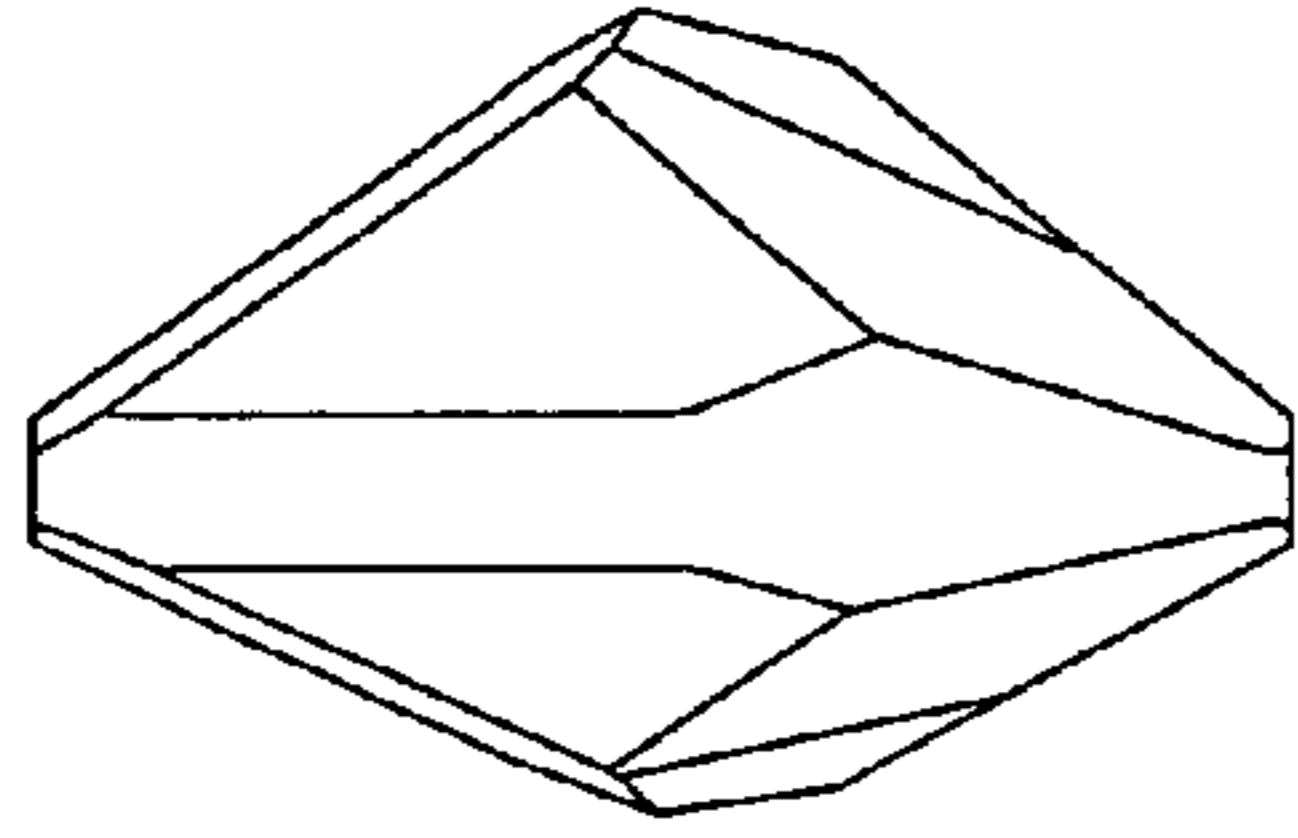

Fig. 2

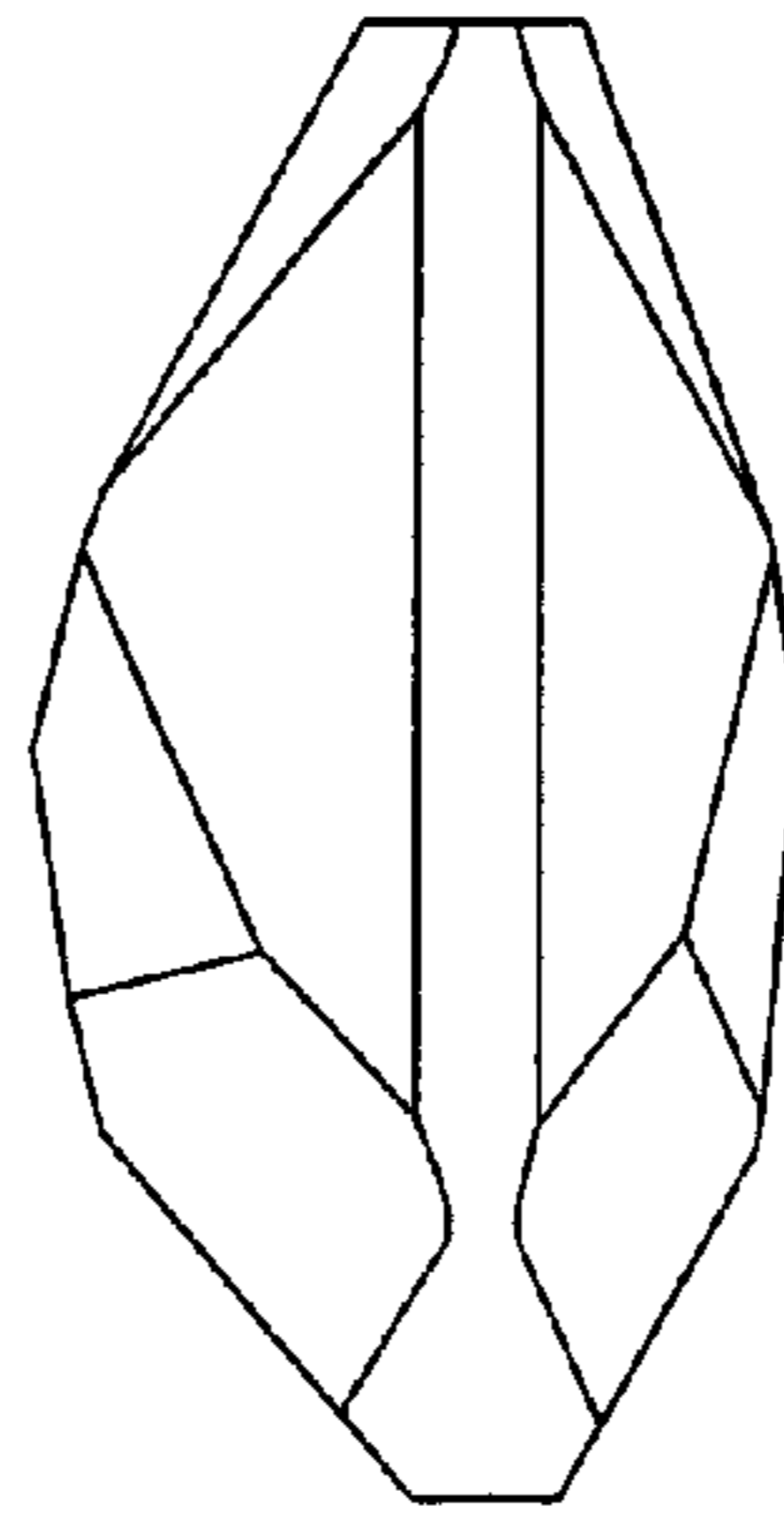

Fig. 3

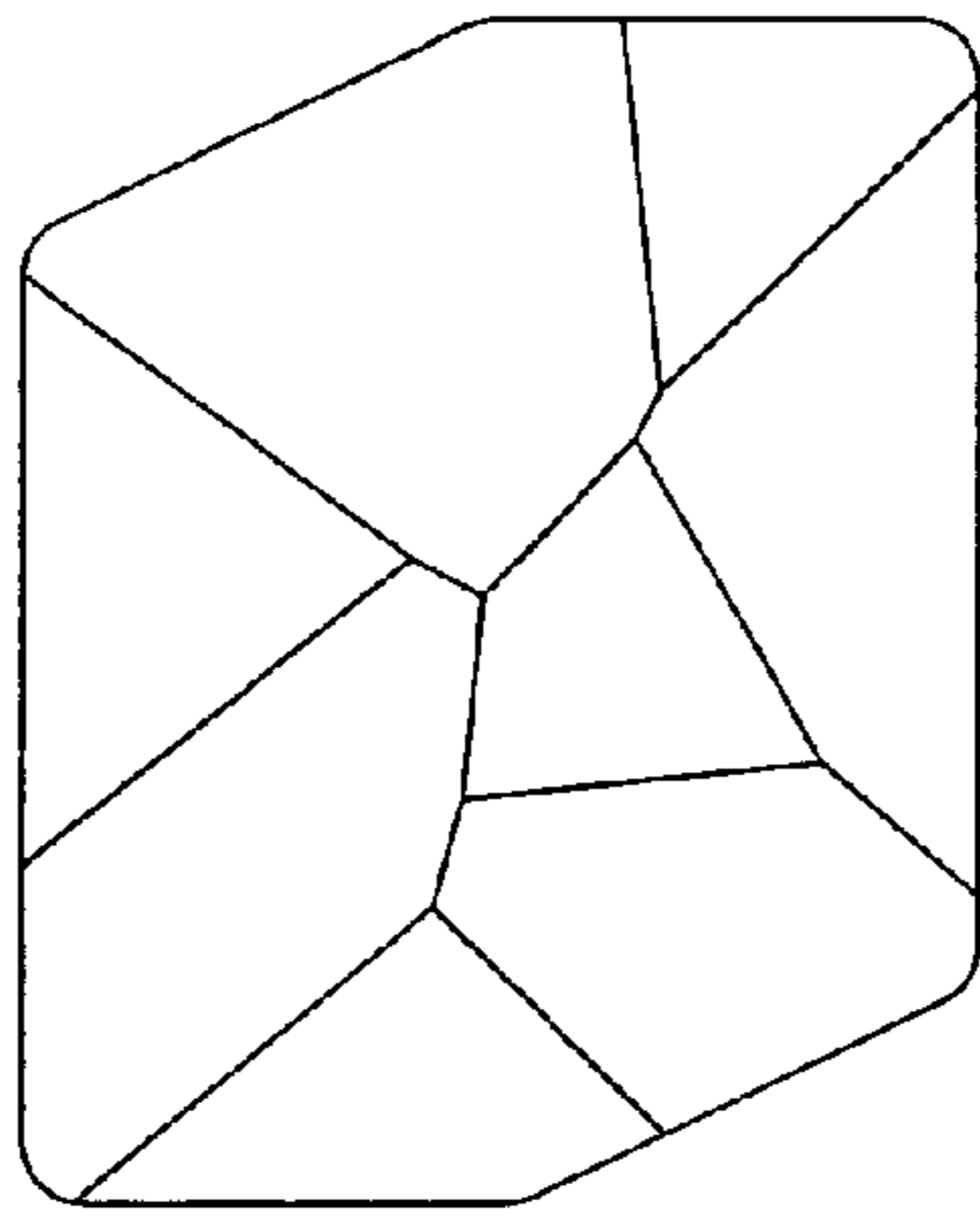

Fig. 4

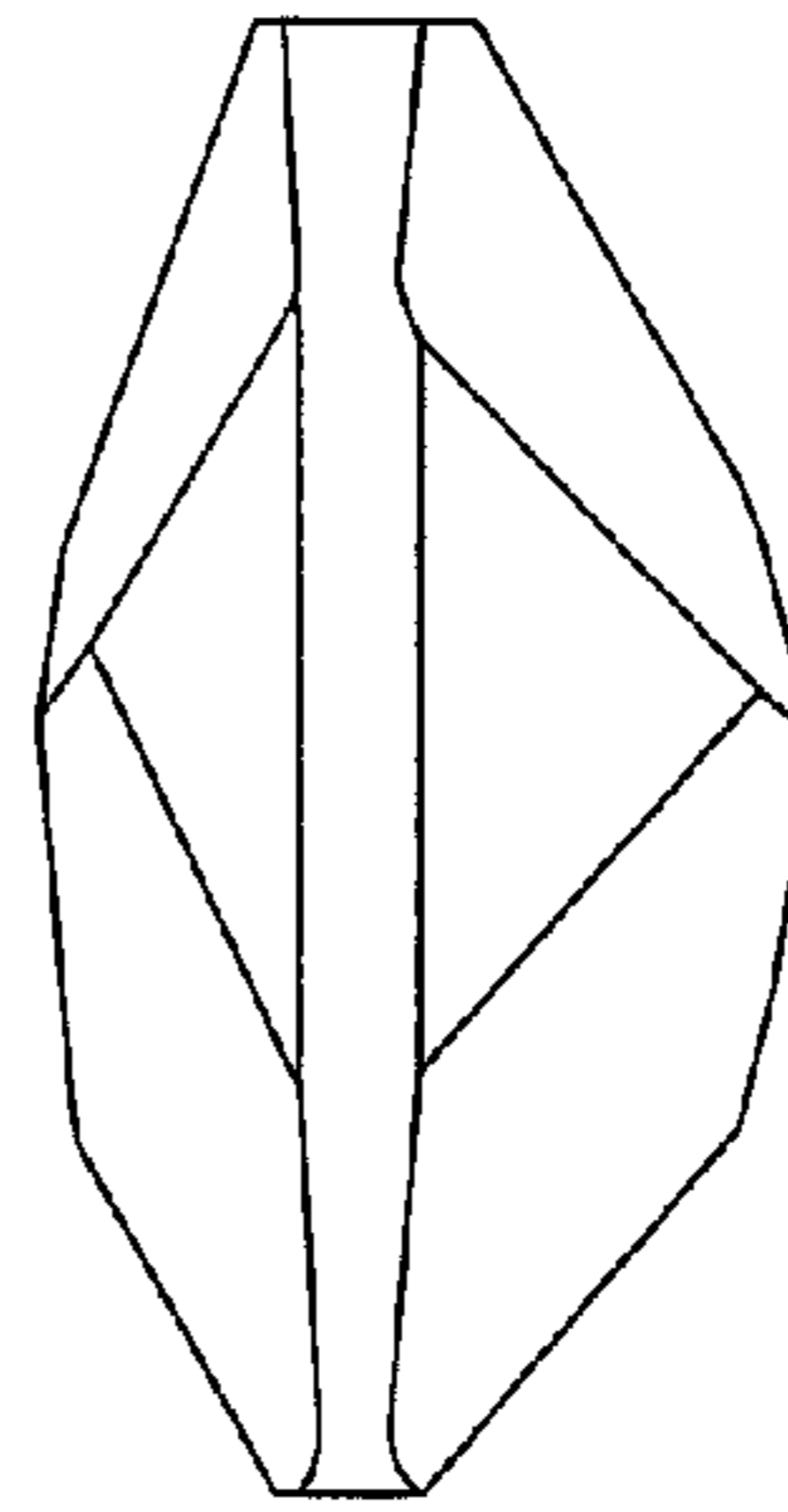

Fig. 5

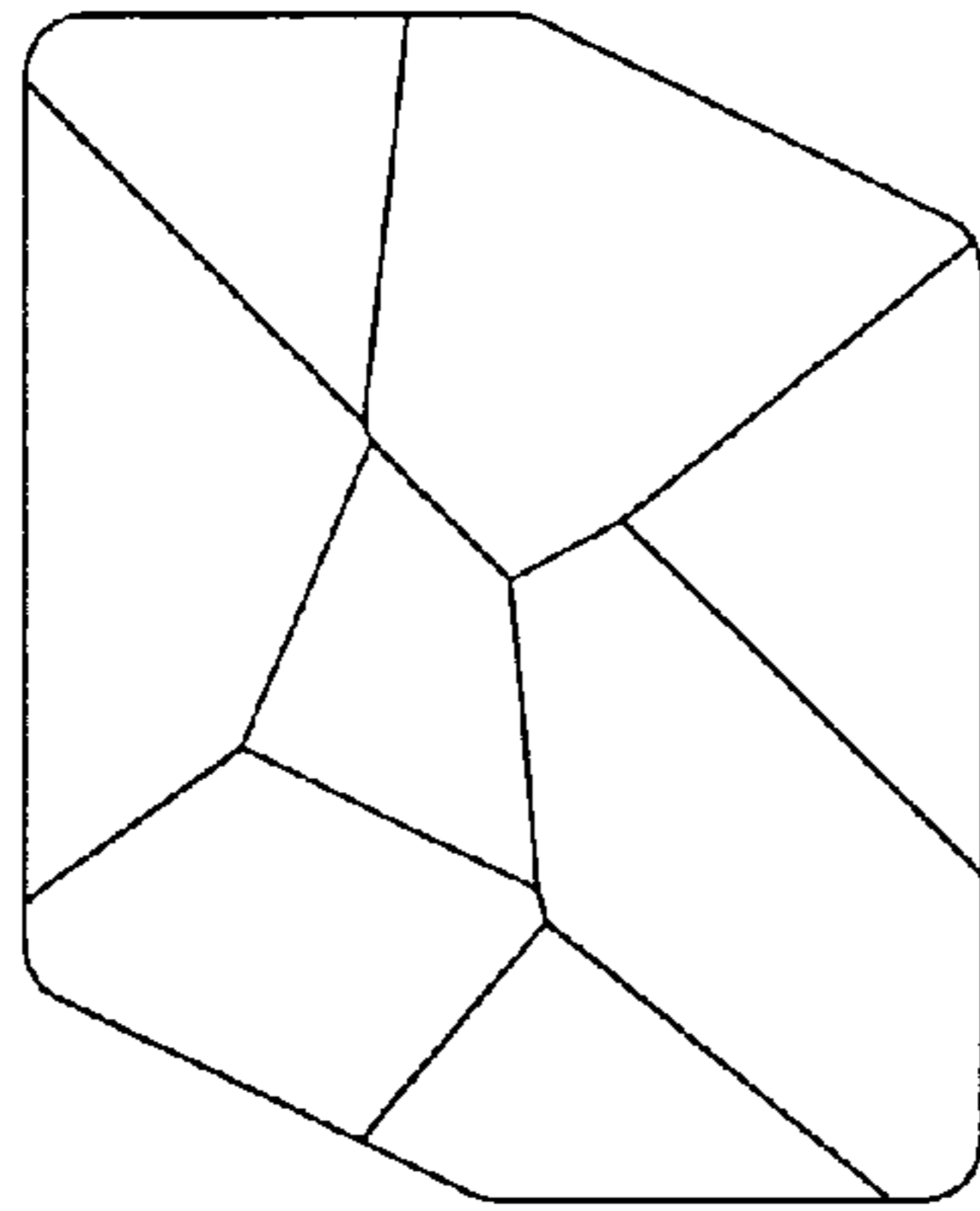

Fig. 6

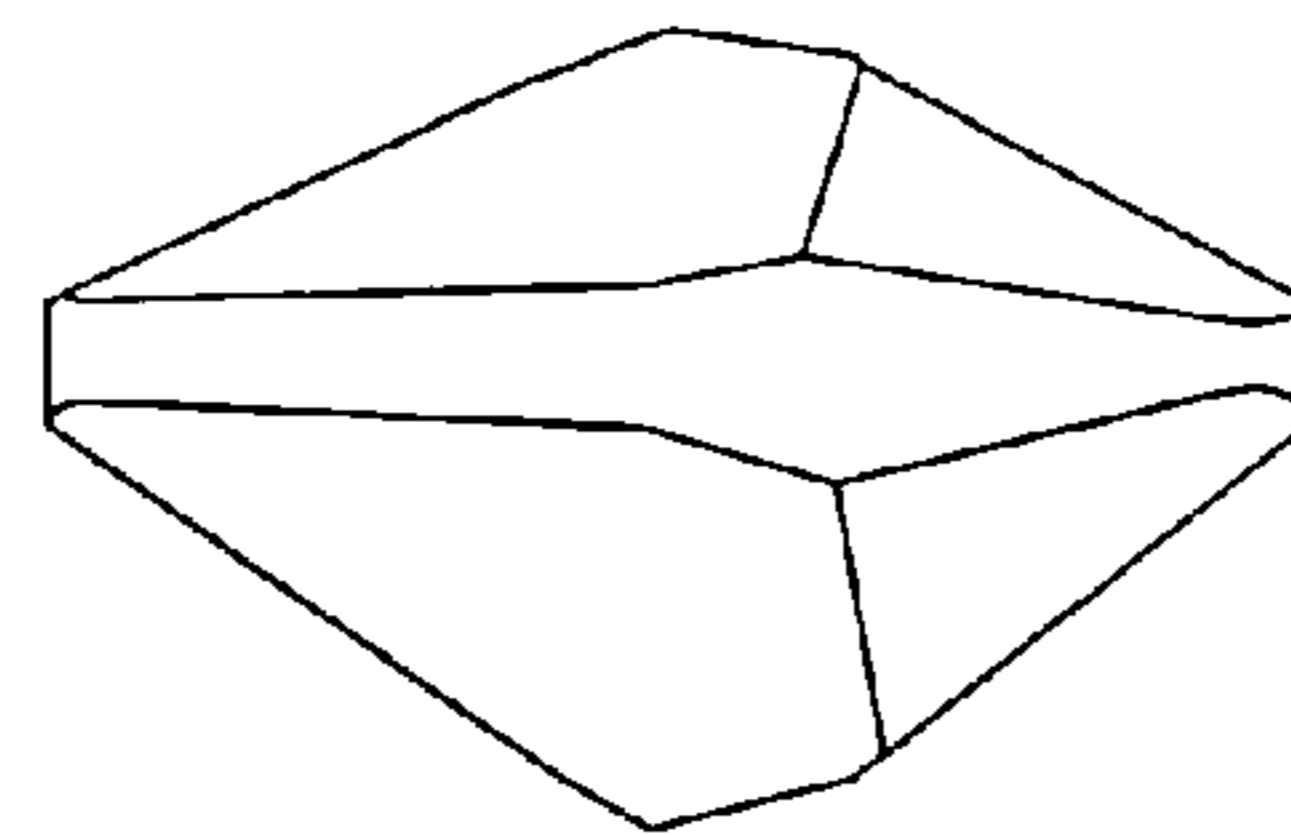

Fig. 7

