



US00D543881S

(12) **United States Design Patent** (10) **Patent No.:** **US D543,881 S**  
**Barmes et al.** (45) **Date of Patent:** **\*\* Jun. 5, 2007**

(54) **SCALE**

(57) **CLAIM**

(76) Inventors: **Nathan L. Barmes**, 145 Daleview Dr., Vincennes, IN (US) 47591; **Dustin P. Barmes**, 1171 N. Atkinson Rd., Vincennes, IN (US) 47591

The ornamental design for a scale, as shown and described.

(\*\*) Term: **14 Years**

**DESCRIPTION**

(21) Appl. No.: **29/264,078**

FIG. 1 is a top plan view of a scale of the present invention in a "closed position".

(22) Filed: **Aug. 3, 2006**

FIG. 2 is a top plan view of a scale of the present invention in an "open position".

(51) **LOC (8) Cl.** ..... **10-04**

FIG. 3 is an elevation view of the scale as viewed from the left side of FIG. 1.

(52) **U.S. Cl.** ..... **D10/91**

(58) **Field of Classification Search** ..... D10/87-95; 177/4, 25.12-25.16, 177, 199, 210 R, 238-245, 177/DIG. 3, 262, 210 C, 30, 126-127; 324/692, 324/512, 515, 806; 600/506, 547  
See application file for complete search history.

FIG. 4 is an elevation view of the scale as viewed from the left side of FIG. 2.

FIG. 5 is an elevation view of the scale as viewed from the right side of FIG. 1.

(56) **References Cited**

FIG. 6 is an elevation view of the scale as viewed from the right side of FIG. 2.

**U.S. PATENT DOCUMENTS**

FIG. 7 is an elevation view of the scale as viewed from the bottom of FIG. 1.

D448,316 S	9/2001	Kesselman	
D470,782 S *	2/2003	Motomizu	D10/92
D472,833 S *	4/2003	Thadani	D10/91
D505,348 S *	5/2005	Lee	D10/91
D518,398 S *	4/2006	Kesselman	D10/91
D519,048 S *	4/2006	Kesselman	D10/91
D520,891 S *	5/2006	Motomizu et al.	D10/91
D521,889 S *	5/2006	Kesselman	D10/91
D521,890 S *	5/2006	Motomizu et al.	D10/91
D524,671 S *	7/2006	Huang	D10/91
D529,831 S *	10/2006	Malhi	D10/91
D531,075 S *	10/2006	Vantine	D10/92

FIG. 8 is an elevation view of the scale as viewed from the bottom of FIG. 2.

FIG. 9 is an elevation view of the scale as viewed from the top of FIG. 1.

FIG. 10 is an elevation view of the scale as viewed from the top of FIG. 2.

\* cited by examiner

FIG. 11 is a bottom plan view of the scale shown in FIG. 1.

FIG. 12 is a bottom plan view of the scale shown in FIG. 2; and,

*Primary Examiner*—Antoine D. Davis  
(74) *Attorney, Agent, or Firm*—Brinks Hofer Gilson & Lione

FIG. 13 is a perspective view from the bottom left of FIG. 1.

**1 Claim, 9 Drawing Sheets**

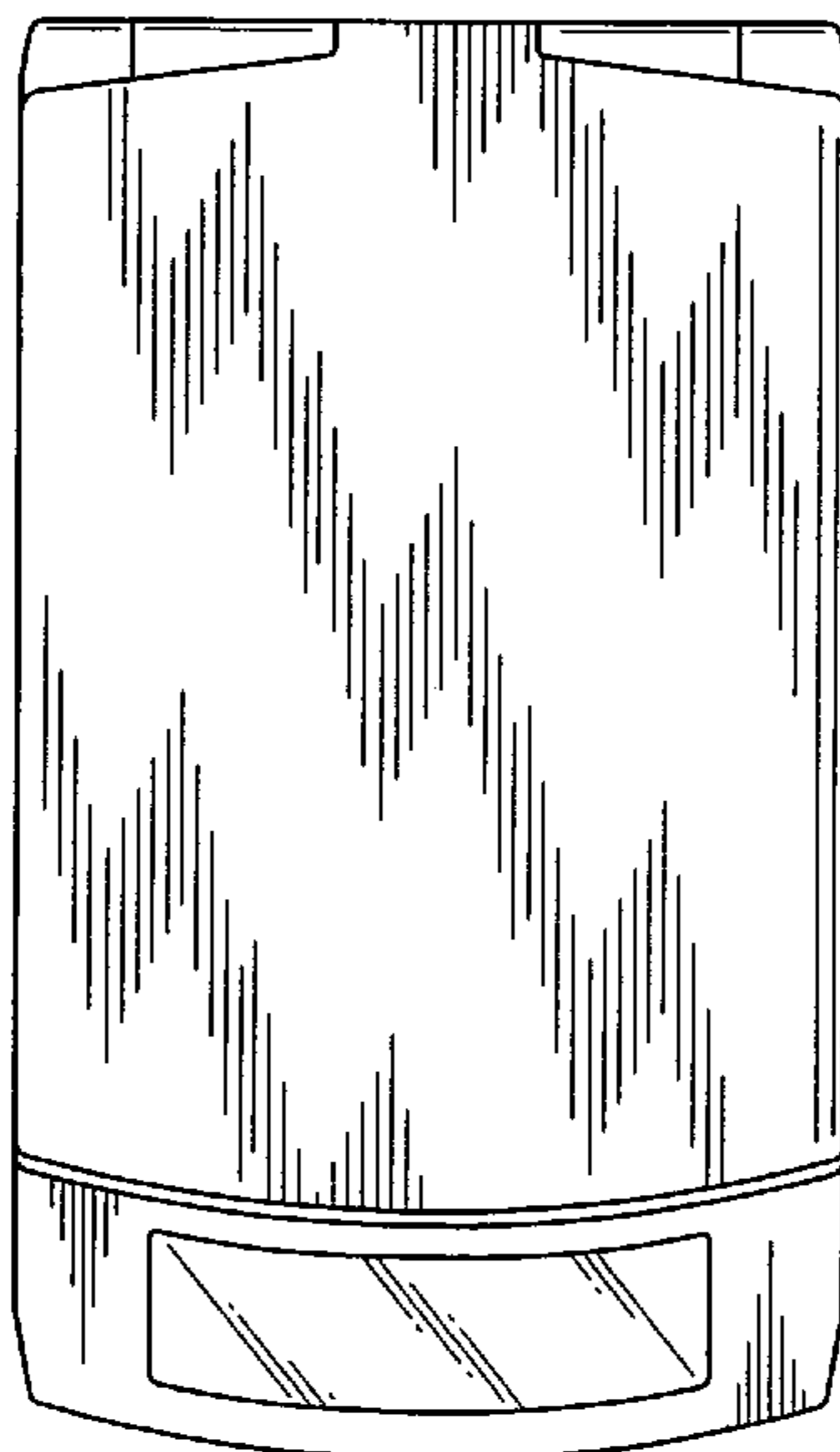

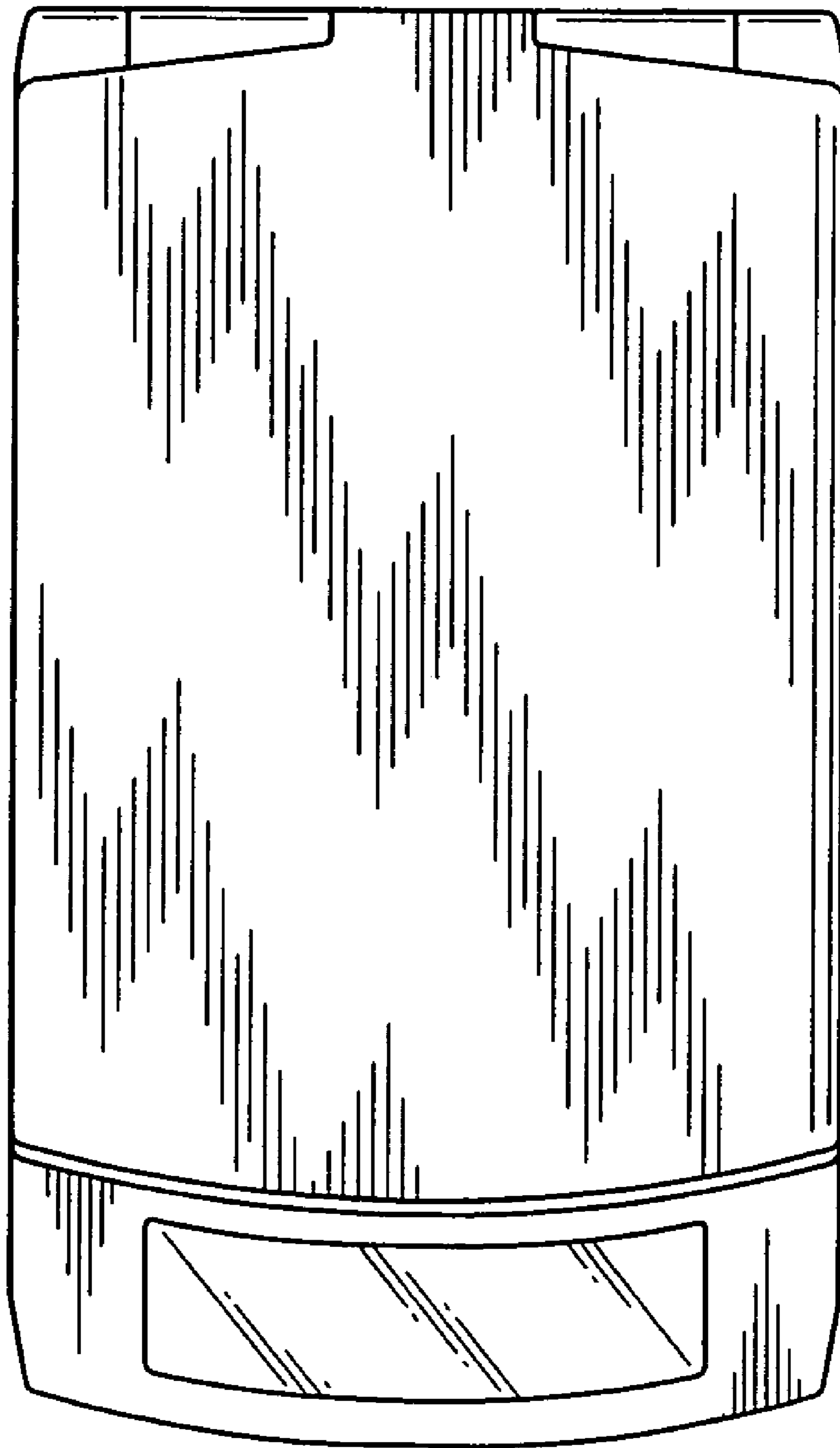

Fig. 1

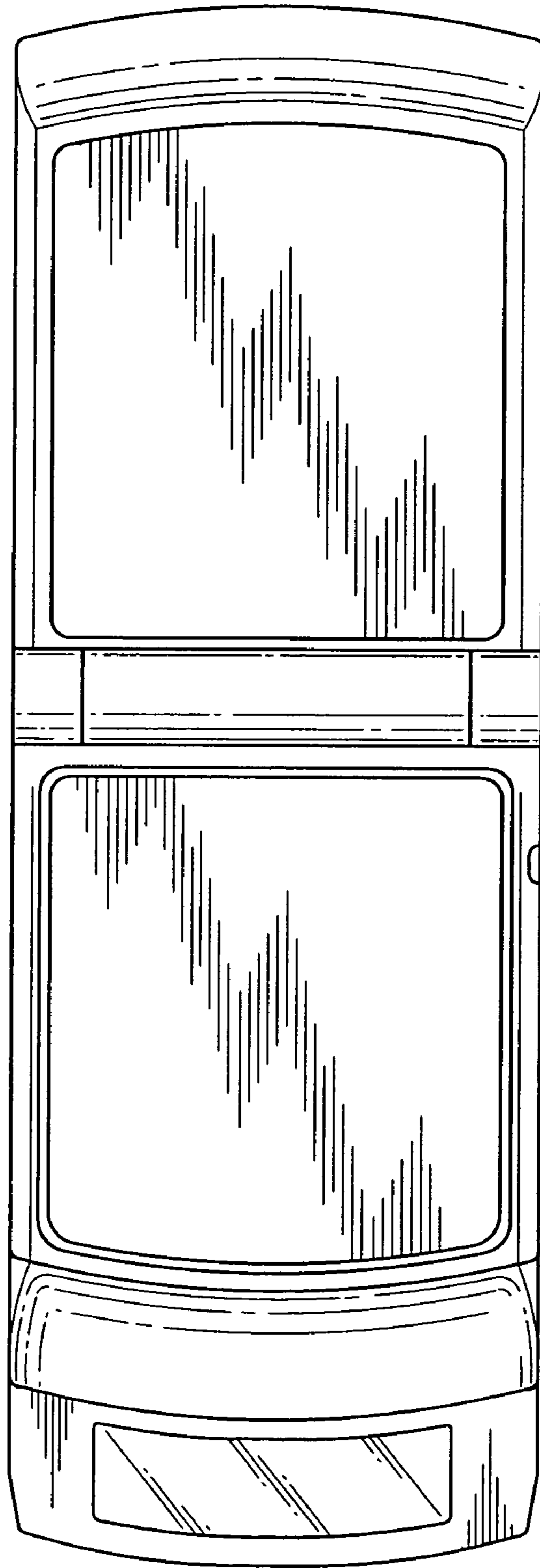

Fig. 2

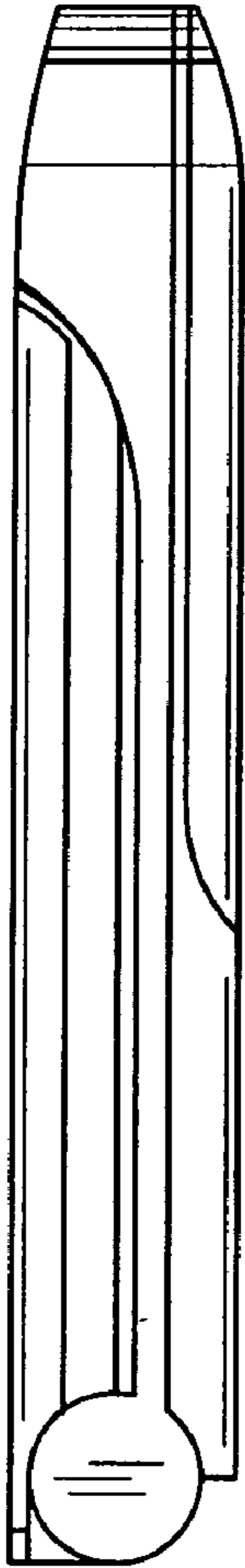

Fig. 3

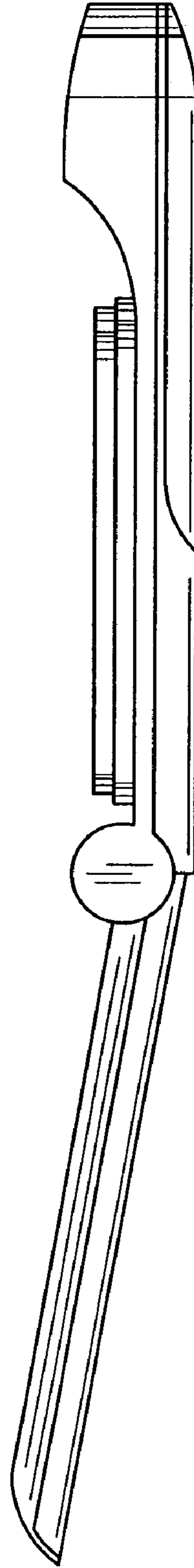

Fig. 4

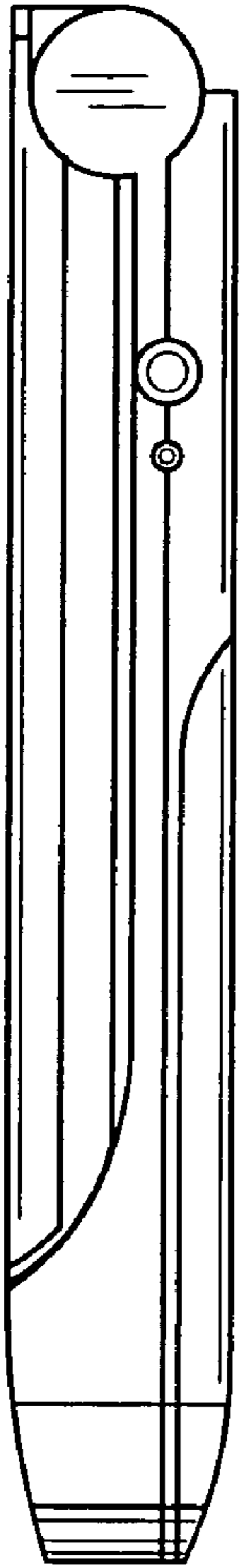

Fig. 5

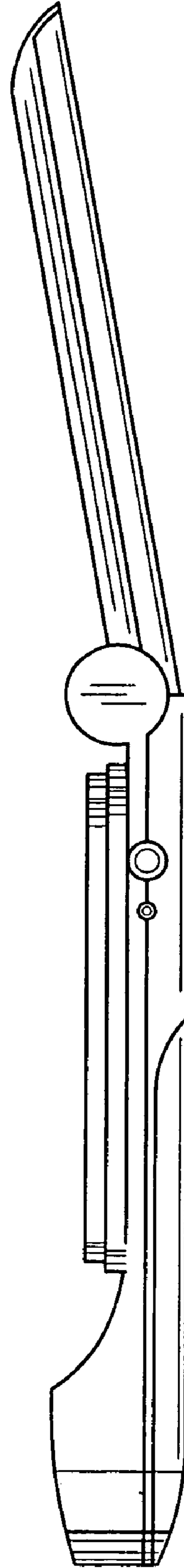

Fig. 6

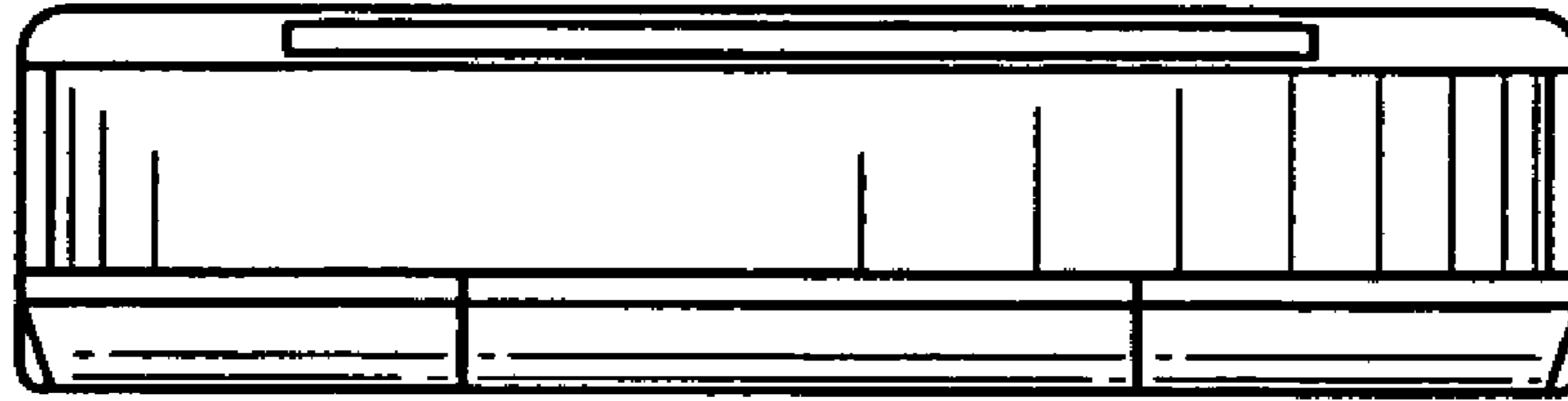

Fig. 7

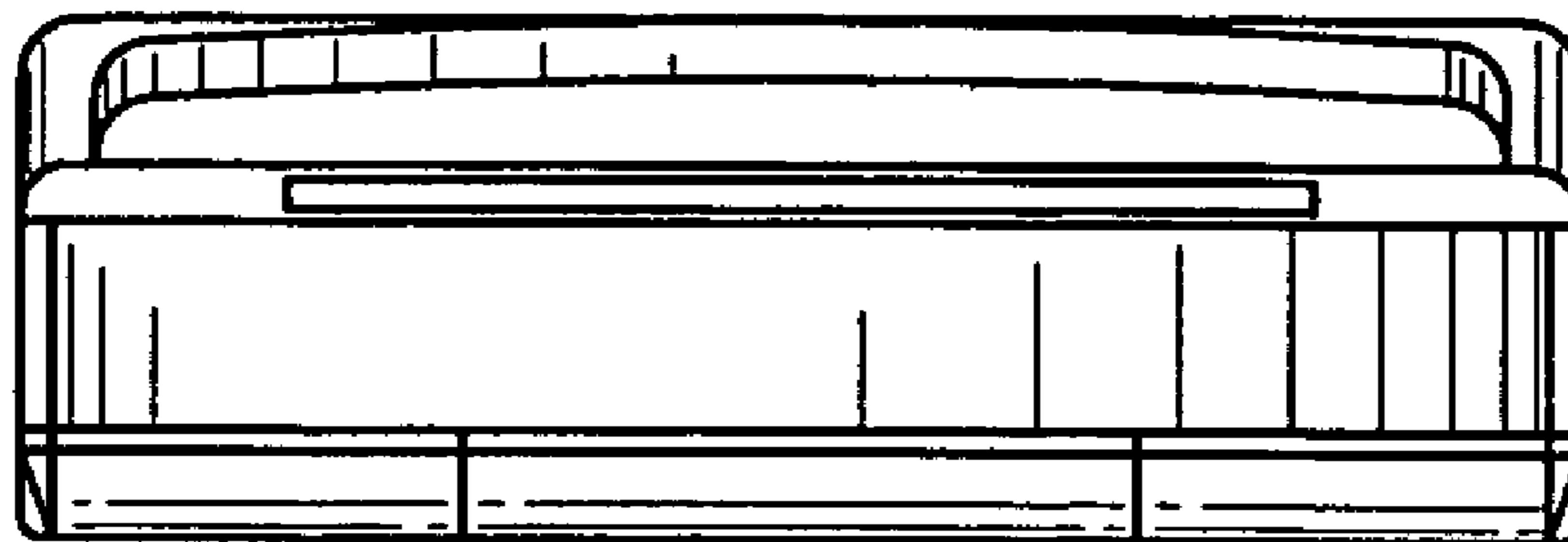

Fig. 8

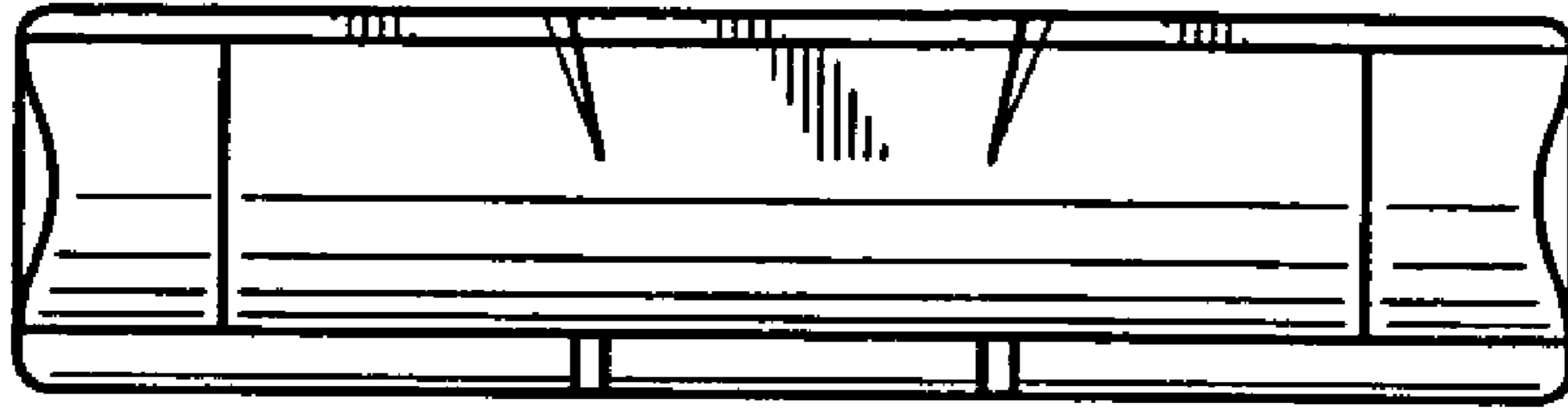

Fig. 9

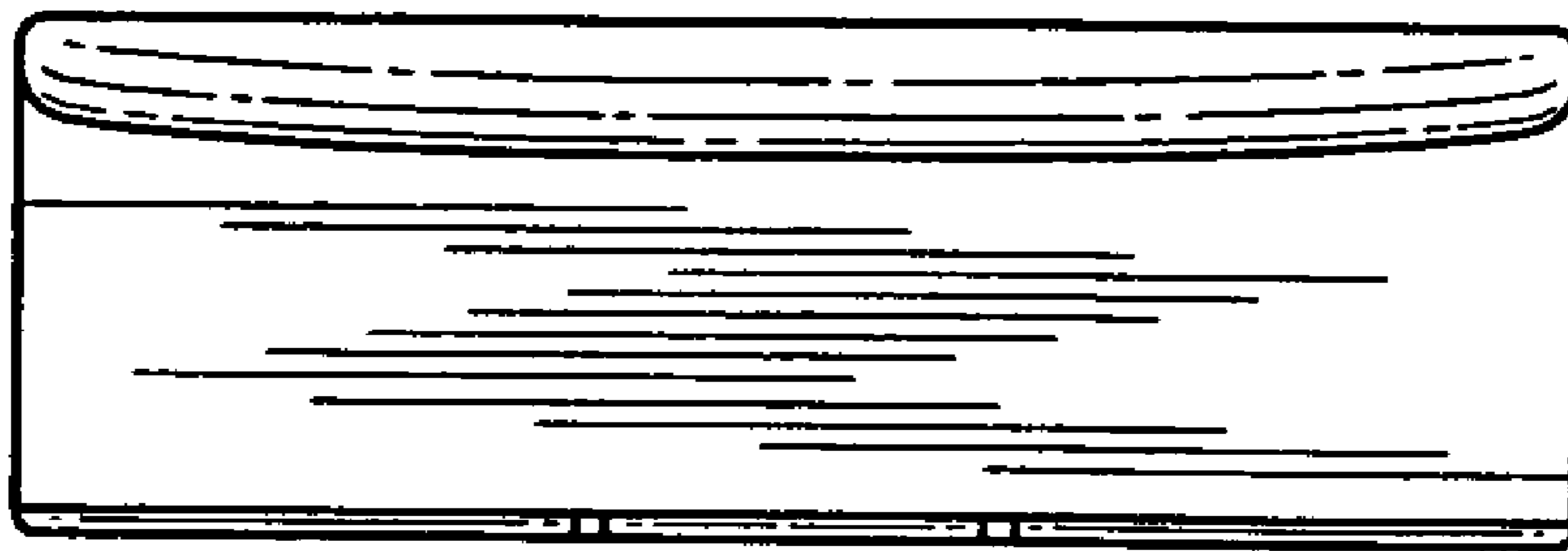

Fig. 10

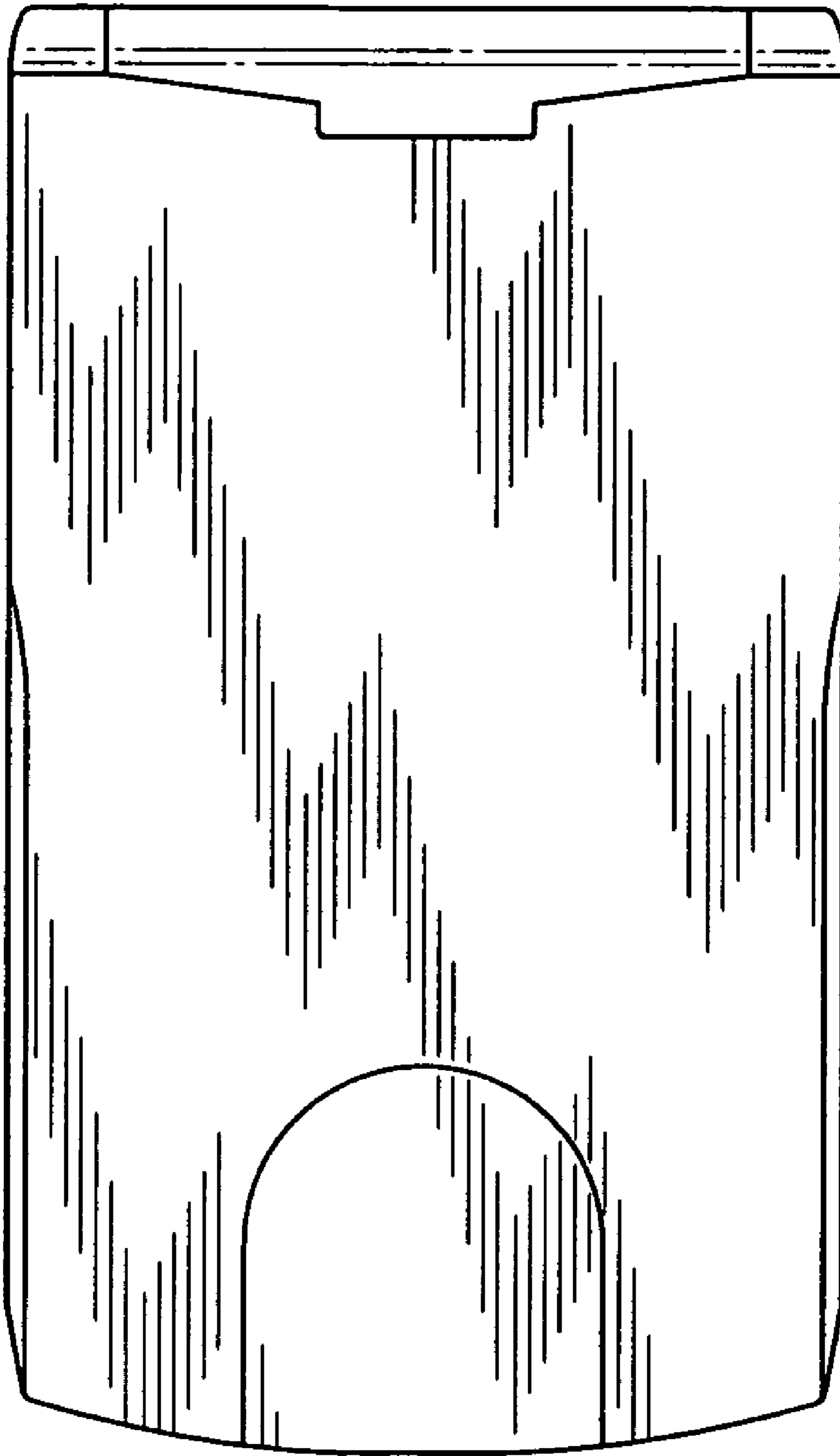

Fig. 11



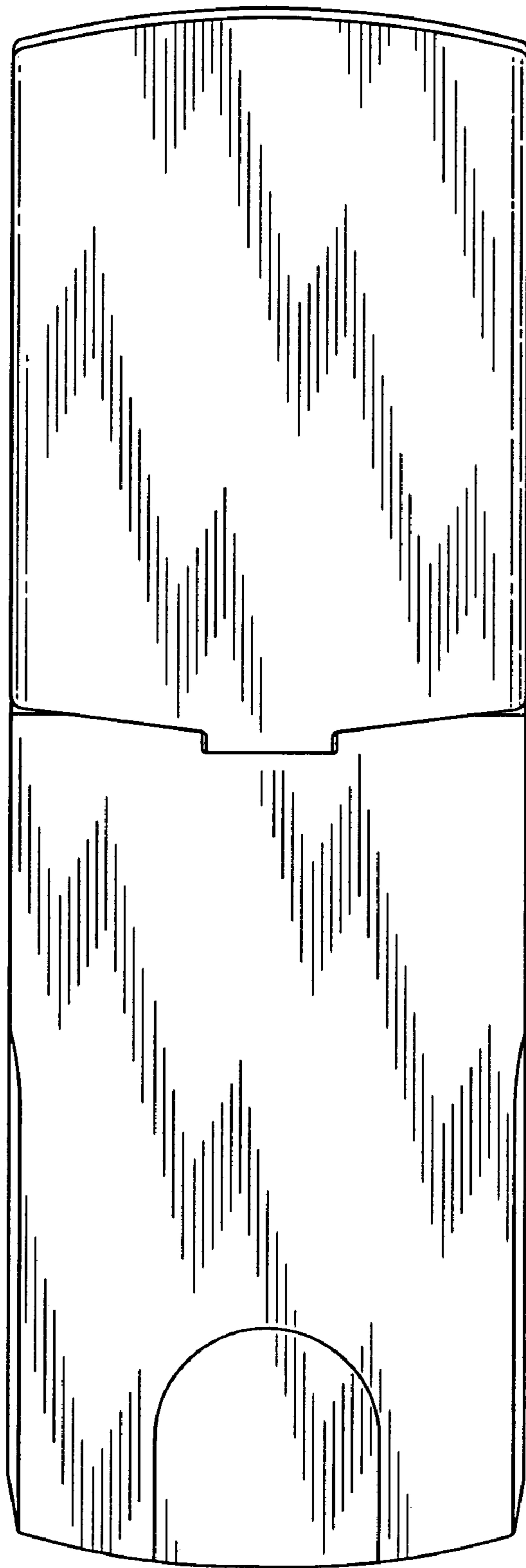

Fig. 12

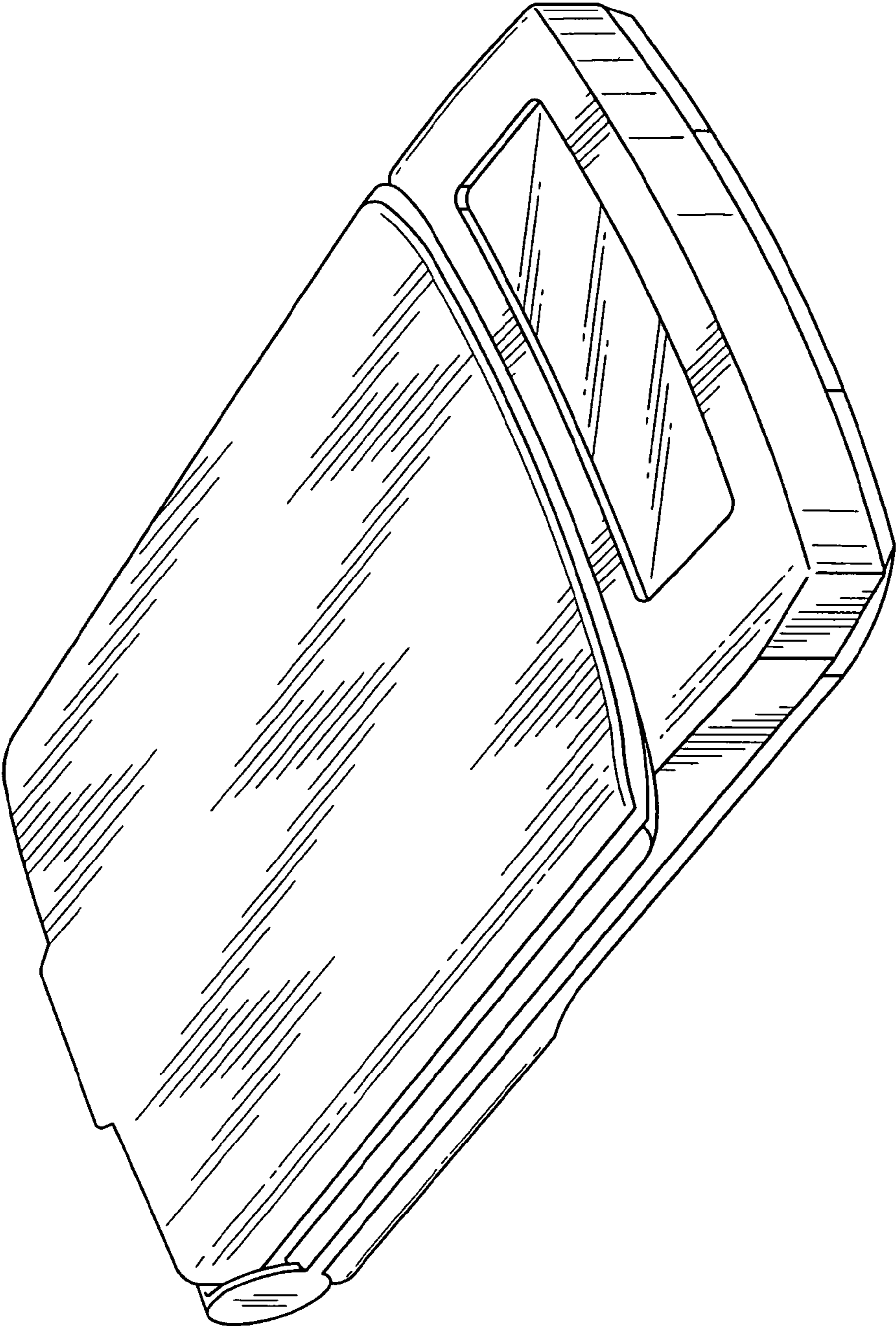

Fig. 13