



US00D543868S

(12) **United States Design Patent**  
**Bhavnani**

(10) **Patent No.:** **US D543,868 S**  
(45) **Date of Patent:** **\*\* Jun. 5, 2007**

(54) **COMBINED TRAVEL MIRROR AND CLOCK**

(75) Inventor: **Dilip Bhavnani**, Beverly Hills, CA  
(US)

(73) Assignee: **Sun Coast Merchandise Corporation**,  
Commerce, CA (US)

(\*\*) Term: **14 Years**

(21) Appl. No.: **29/246,891**

(22) Filed: **May 18, 2006**

(51) **LOC (8) Cl.** ..... **10-01**

(52) **U.S. Cl.** ..... **D10/2; D10/15; D6/312**

(58) **Field of Classification Search** ..... D10/1-29;  
368/276-278, 285-286, 316-7, 10, 28-30,  
368/82-84, 292, 239-242, 223, 226, 243-247;  
359/838, 871; D6/300-302, 308-314; 40/728,  
40/700, 747, 745, 733, 779, 780, 748  
See application file for complete search history.

(56) **References Cited**

U.S. PATENT DOCUMENTS

2,201,251	A	*	5/1940	Van Patten	.....	362/141
D152,347	S	*	1/1949	Marty	.....	D6/301
D215,326	S	*	9/1969	Appel	.....	D10/37
D259,862	S	*	7/1981	You	.....	D10/2
D264,823	S	*	6/1982	Satoh	.....	D10/15
D269,329	S	*	6/1983	Malamoud	.....	D10/18
D274,409	S	*	6/1984	Malamoud	.....	D10/18
D333,271	S	*	2/1993	Erlichman	.....	D10/2
D337,529	S	*	7/1993	Shimamura	.....	D10/18
D357,420	S	*	4/1995	Wong	.....	D10/18

D363,881	S	*	11/1995	Yung	.....	D10/18
D370,129	S	*	5/1996	Freudenfeld	.....	D6/301
D391,257	S	*	2/1998	Ngan	.....	D14/171
D475,302	S	*	6/2003	Chan	.....	D10/15
6,804,170	B1	*	10/2004	Chan	.....	368/88
D503,285	S	*	3/2005	Chen et al.	.....	D6/300
D506,319	S	*	6/2005	Chan	.....	D6/310
D529,823	S	*	10/2006	Tien	.....	D10/2

\* cited by examiner

*Primary Examiner*—Lucy Lieberman

(74) *Attorney, Agent, or Firm*—The Soni Law Firm

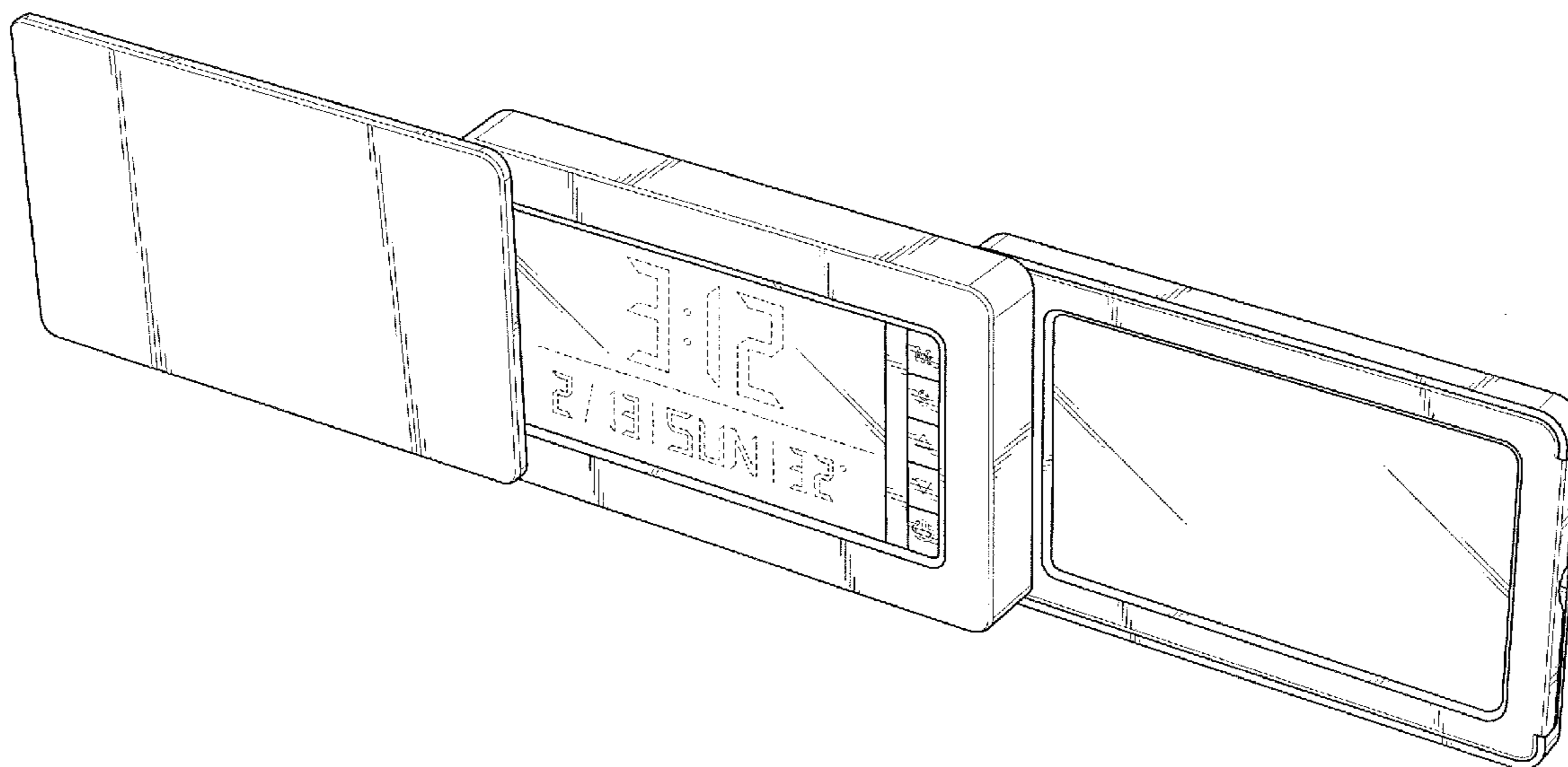
(57) **CLAIM**

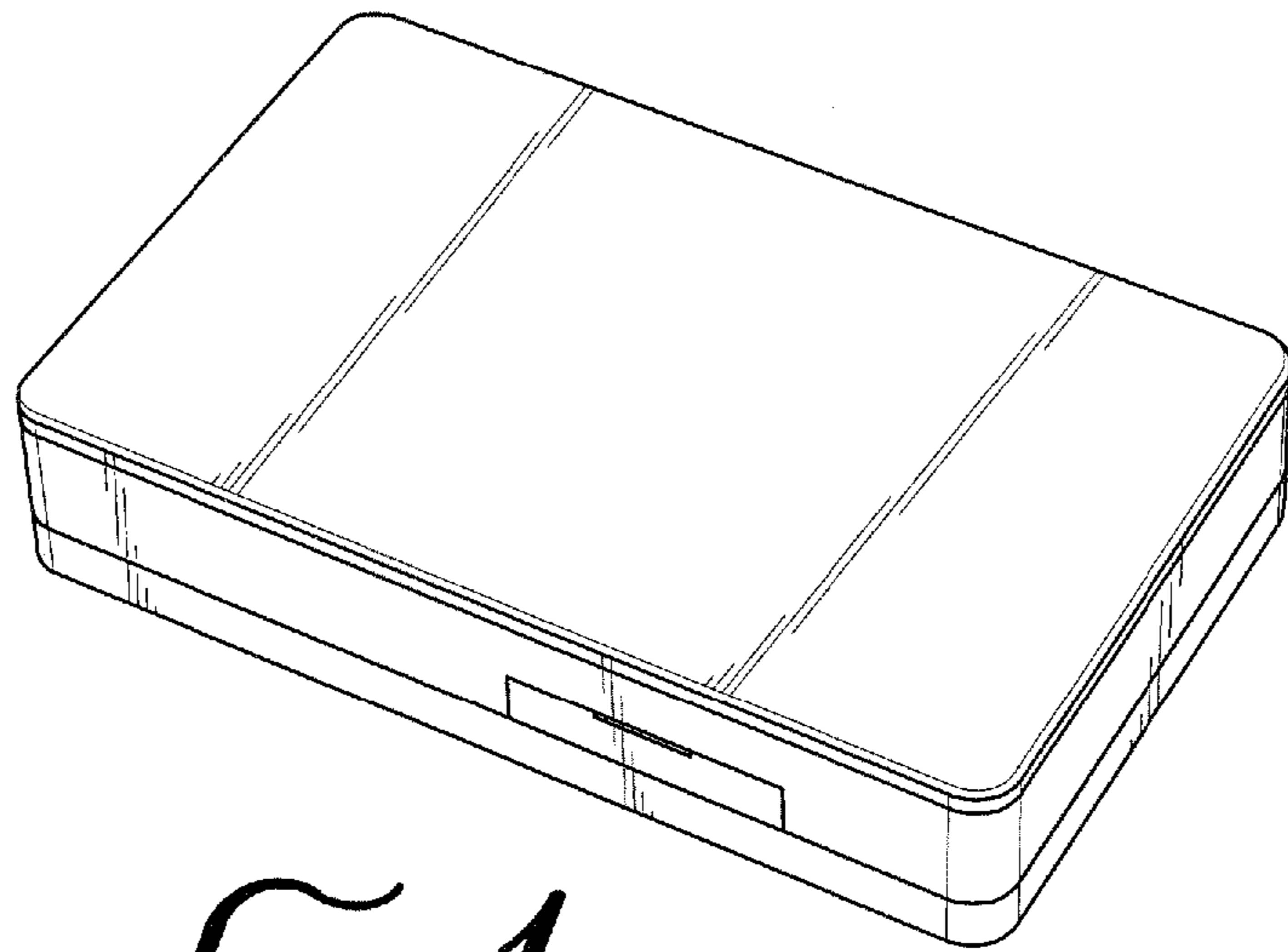
The ornamental design for a combined travel mirror and clock, as shown and described.

**DESCRIPTION**

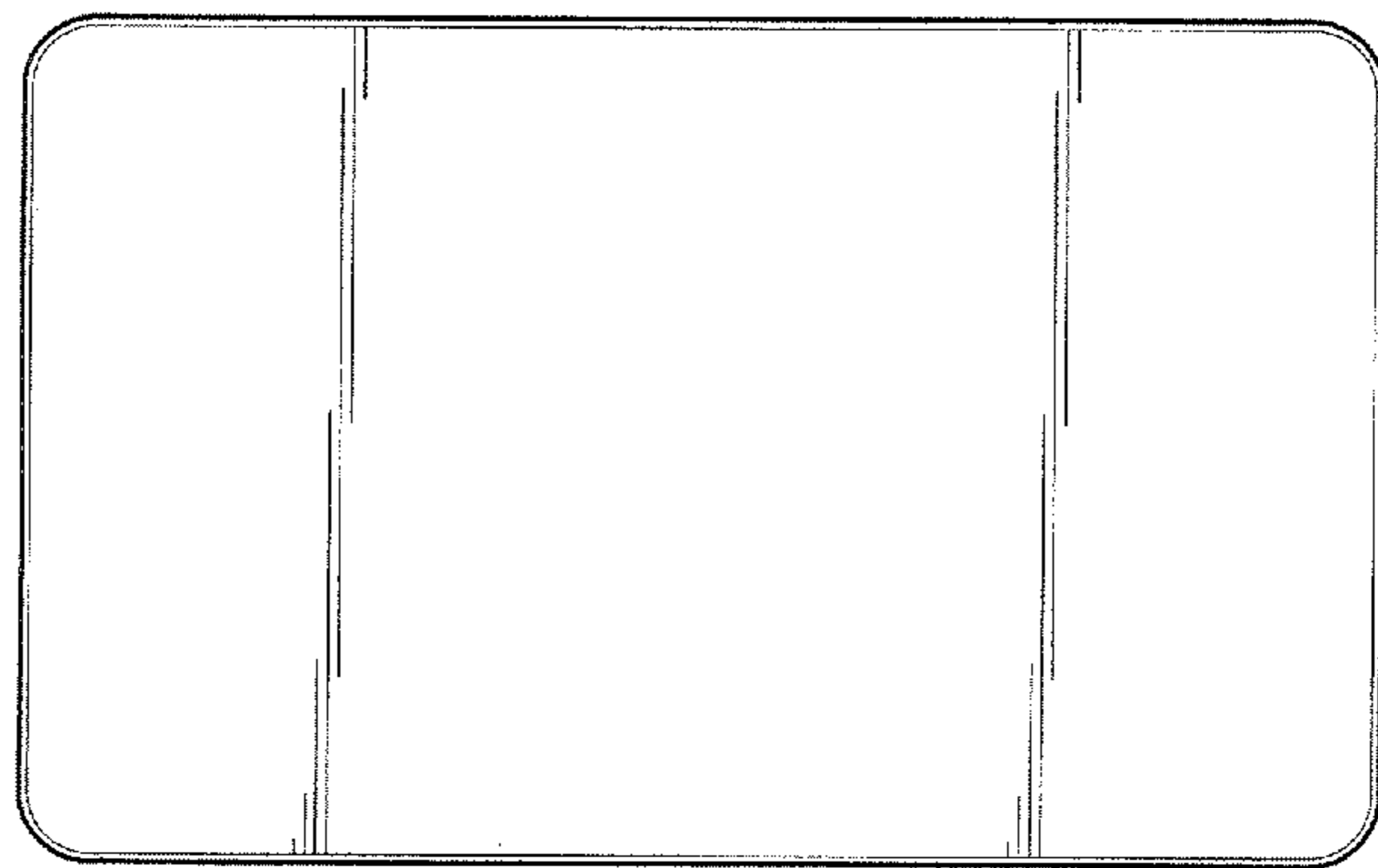
FIG. 1 is a top, front and right side perspective view of a combined travel mirror and clock showing my new design; FIG. 2 is a top plan view thereof; FIG. 3 is a front elevational view thereof; FIG. 4 is a rear elevation thereof; FIG. 5 is a right side elevation thereof; FIG. 6 is a left side elevation thereof; and, FIG. 7 is an alternate top back side perspective view thereof illustrating the top and bottom covers in extended positions, with the phantom lines depicting environmental structure and forming no part of the claimed design.

**1 Claim, 3 Drawing Sheets**

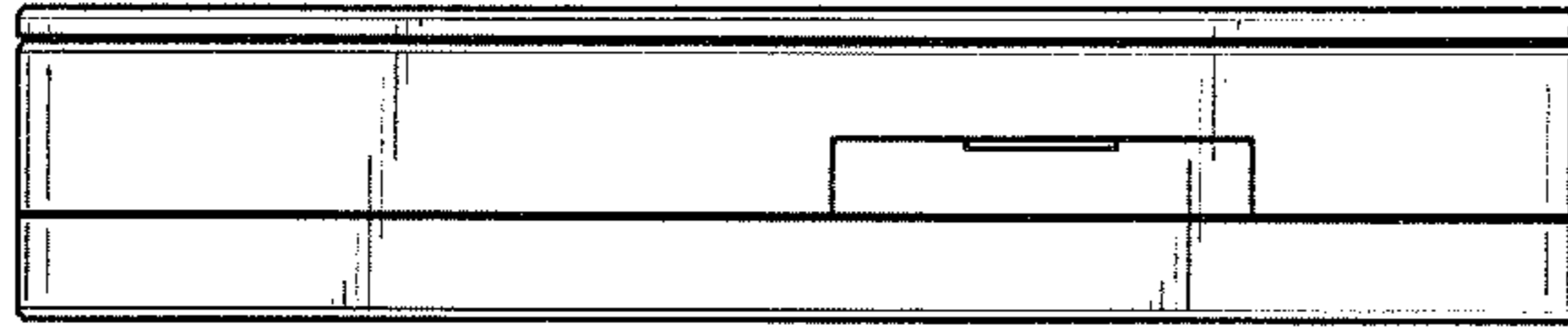




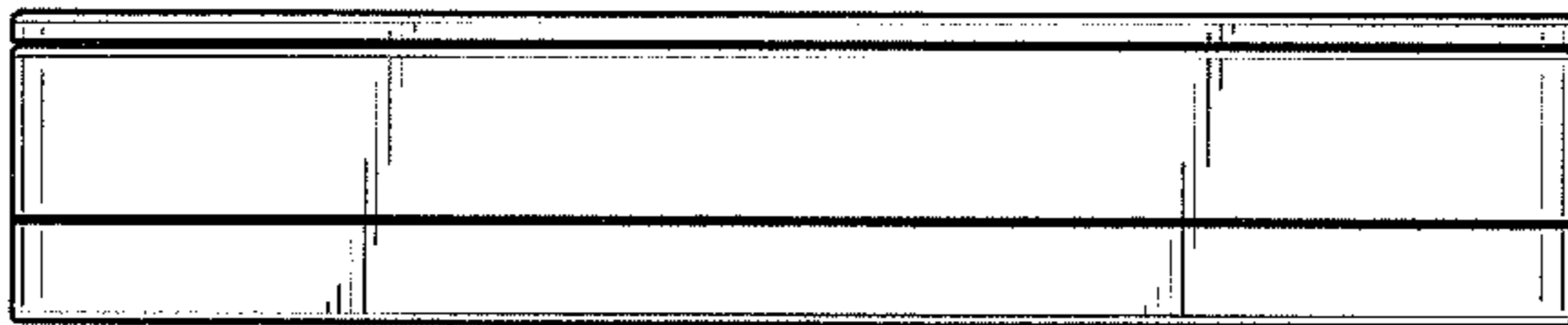
*FIG. 1*



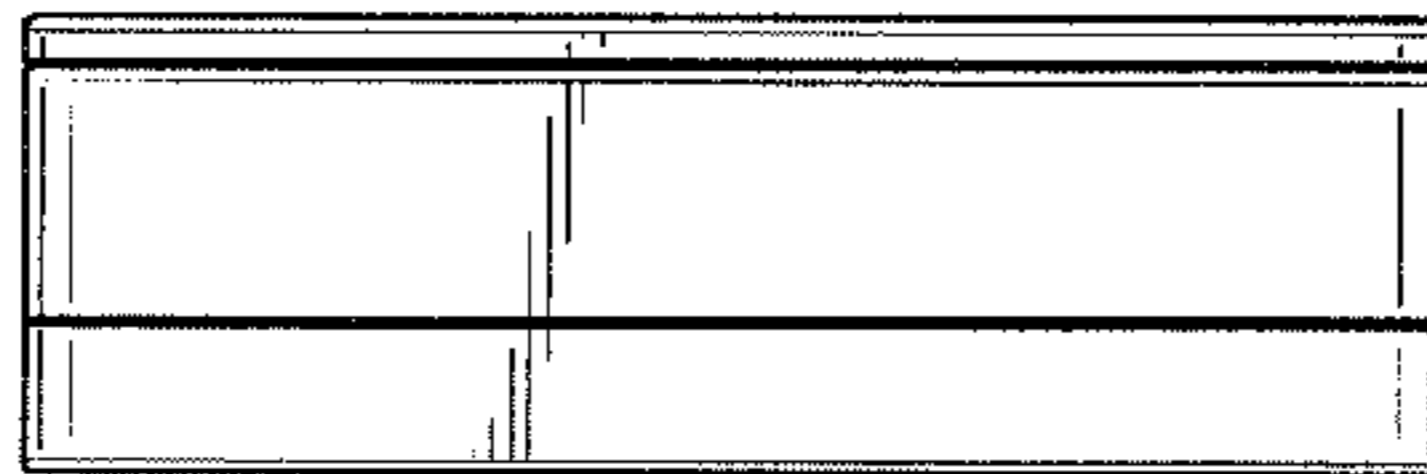
*FIG. 2*



*FIG. 3*



*FIG. 4*



*FIG. 5*



*FIG. 6*

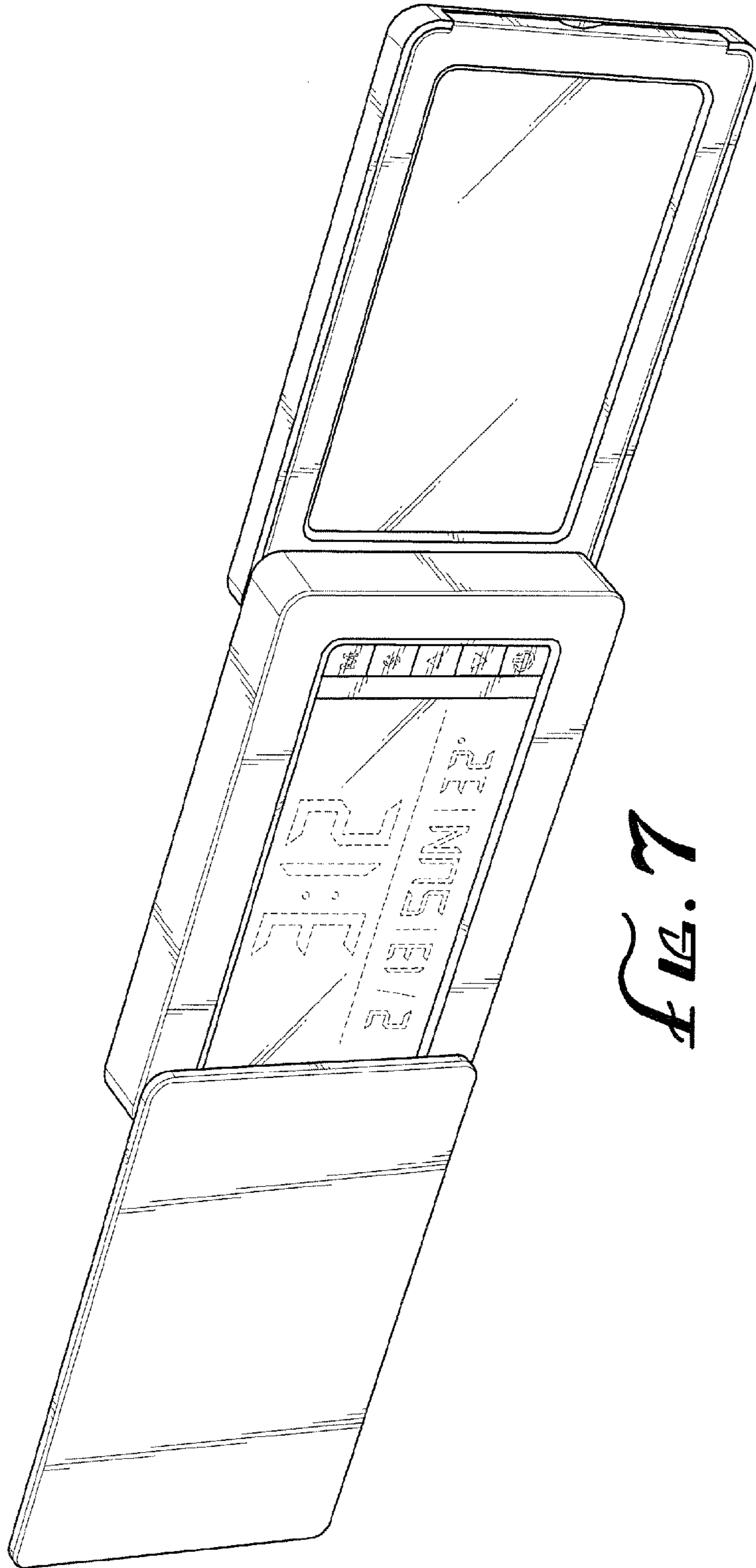


Fig. 7