

US00D543761S

(12) **United States Design Patent**
Wood

(10) **Patent No.:** **US D543,761 S**

(45) **Date of Patent:** **** Jun. 5, 2007**

(54) **UTILITY BOX FOR A LOCKER**

D501,886 S * 2/2005 Chen et al. D6/553
D520,286 S * 5/2006 Chen et al. D6/553
D534,024 S * 12/2006 Dretzka D6/567

(75) Inventor: **George W. Wood**, 3221 E. Calhoun
Pkwy., Minneapolis, MN (US) 55408

* cited by examiner

(73) Assignee: **George W. Wood**, Minneapolis, MN
(US)

Primary Examiner—Brian N Vinson

(**) Term: **14 Years**

(74) *Attorney, Agent, or Firm*—Wood, Phillips, Katz, Clark
& Mortimer

(21) Appl. No.: **29/228,616**

(57) **CLAIM**

(22) Filed: **Apr. 25, 2005**

The ornamental design for a utility box for a locker, as
shown.

(51) **LOC (8) Cl.** **06-04**

(52) **U.S. Cl.** **D6/553**

(58) **Field of Classification Search** D6/552,
D6/553, 567, 574; 211/13.1, 69.1, 70.6,
211/70.7, 71-72, 74-75, 86.01, 87.01, 88.01,
211/90.01, 126.1

DESCRIPTION

See application file for complete search history.

FIG. 1 is a perspective view of the design subject,
FIG. 2 is a front elevational view, thereof;
FIG. 3 is a rear elevational view, thereof;
FIG. 4 is a left side elevational view, thereof;
FIG. 5 is a right side elevational view, thereof;
FIG. 6 is a top plan view, thereof; and,
FIG. 7 is a bottom plan view.

(56) **References Cited**

U.S. PATENT DOCUMENTS

D410,164 S * 5/1999 Rashid D6/567
D494,797 S * 8/2004 Ramnauth et al. D6/553
D497,755 S * 11/2004 Wood et al. D6/553

1 Claim, 3 Drawing Sheets

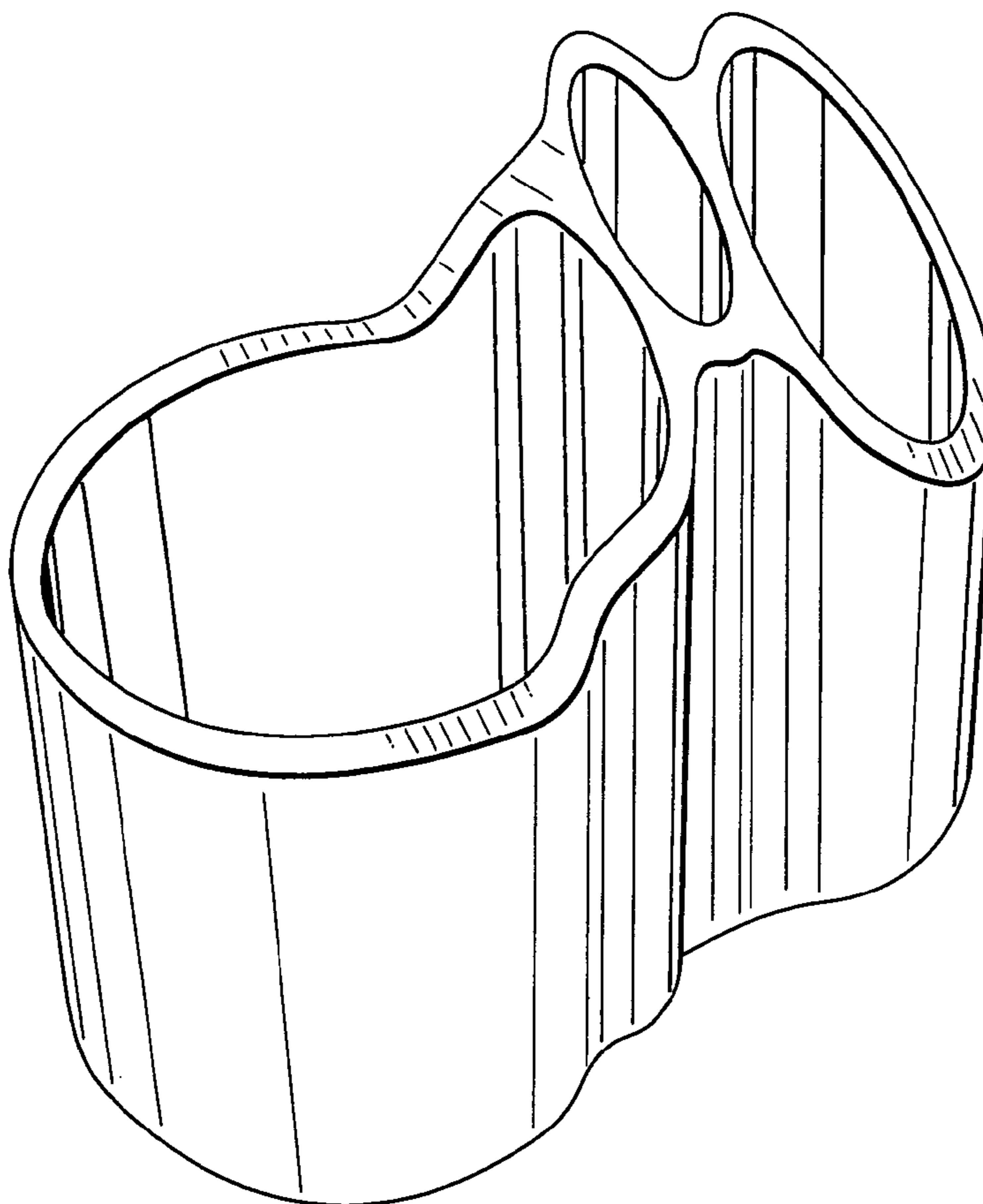

Fig. 1

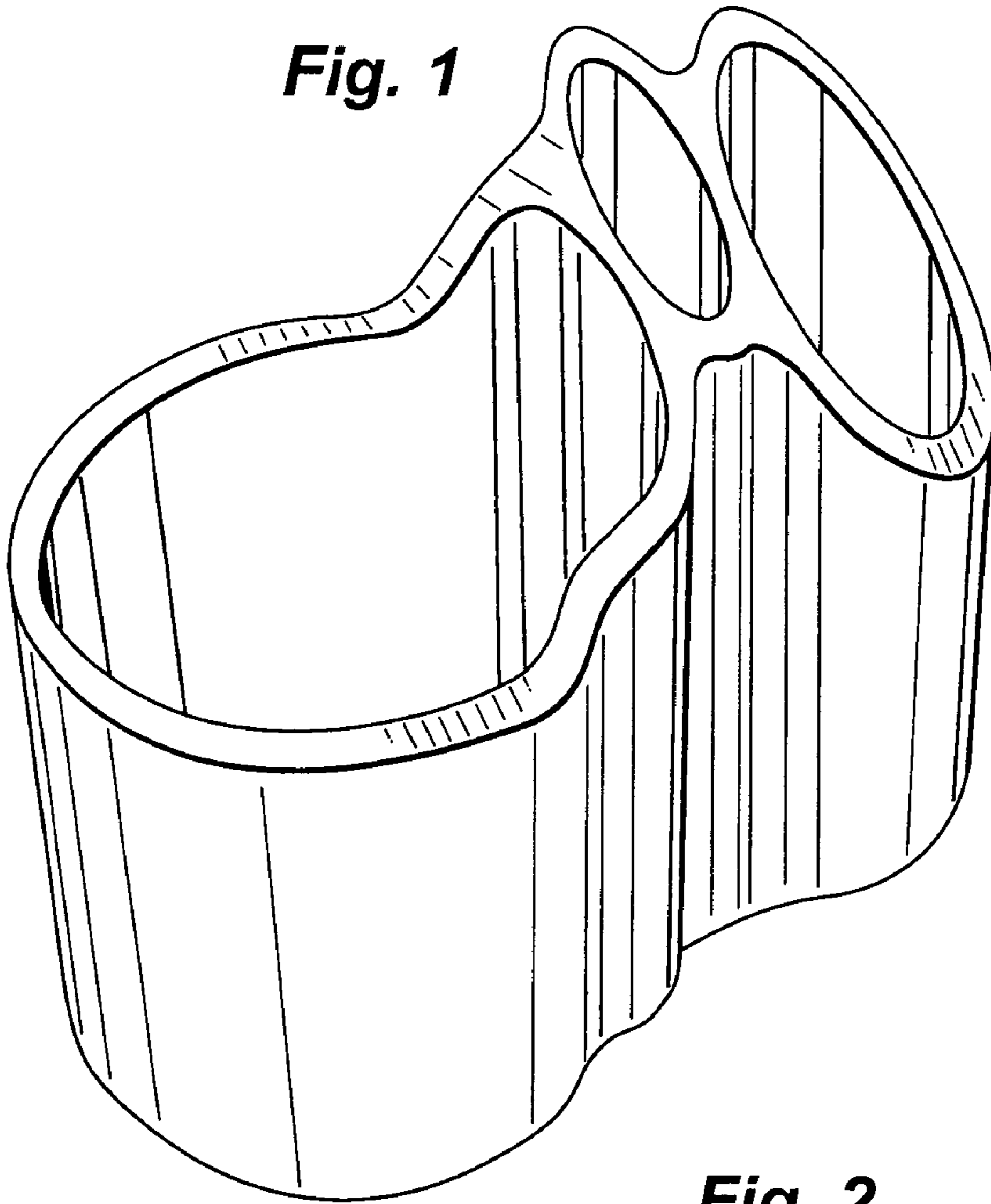

Fig. 2

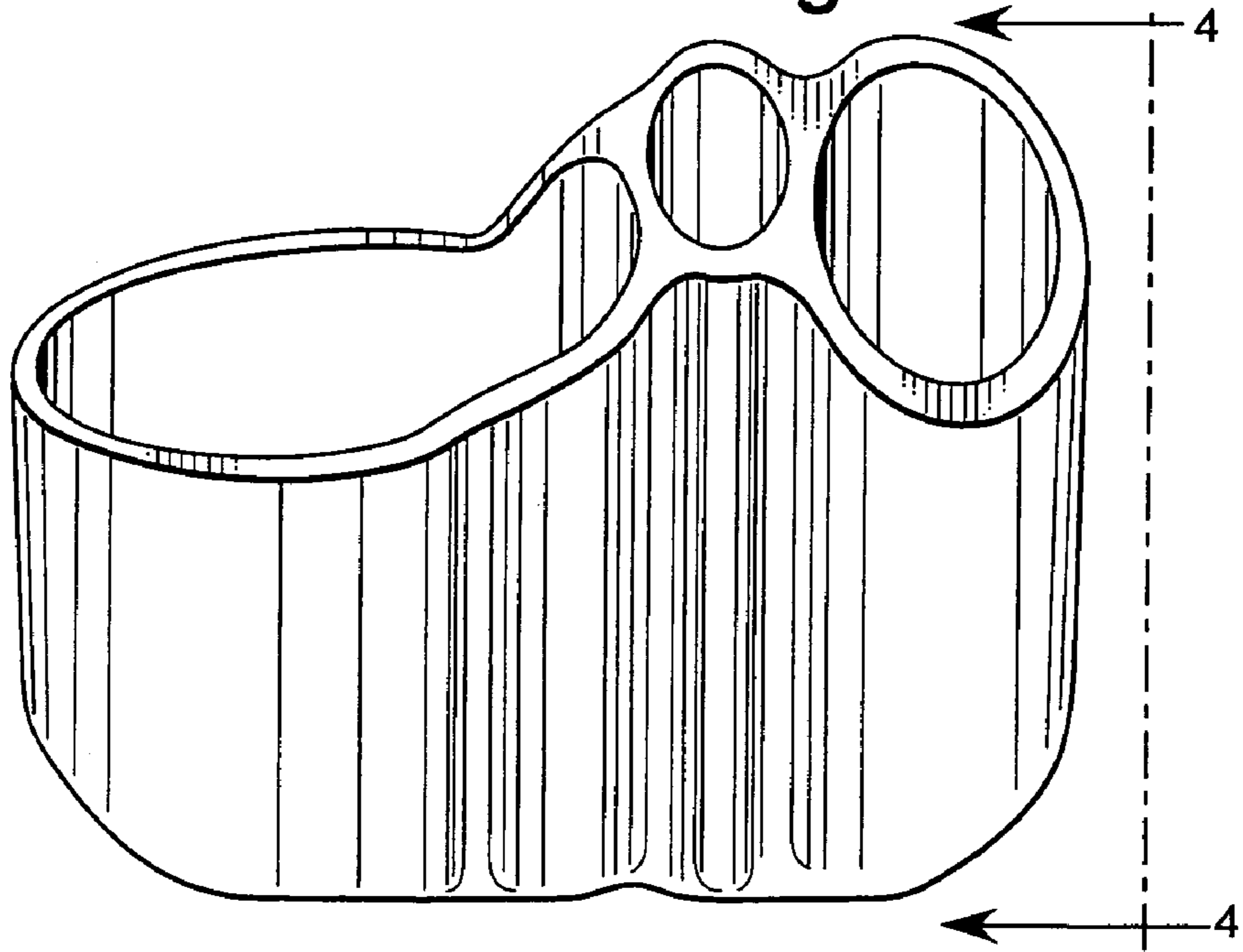

Fig. 3

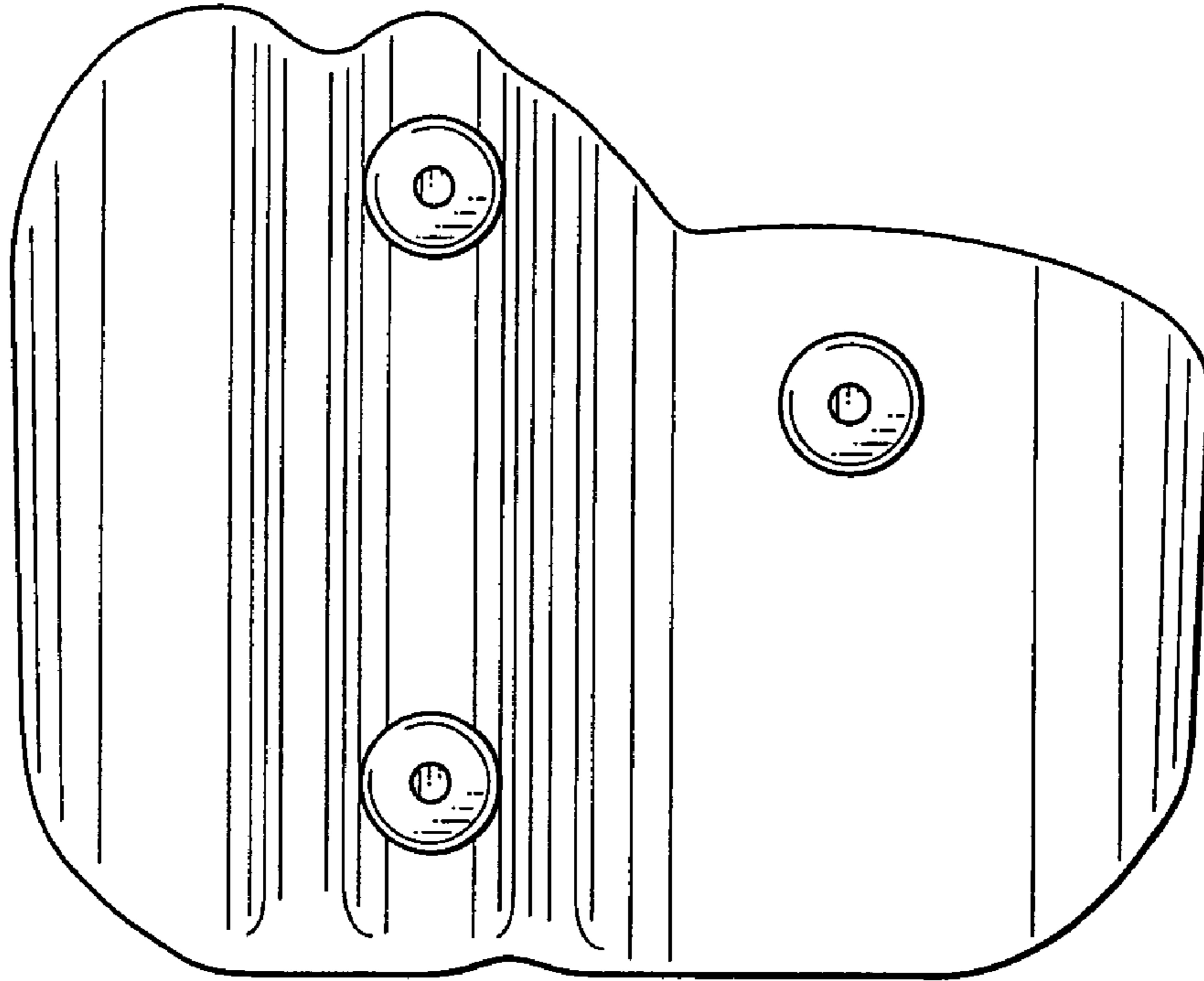

Fig. 4

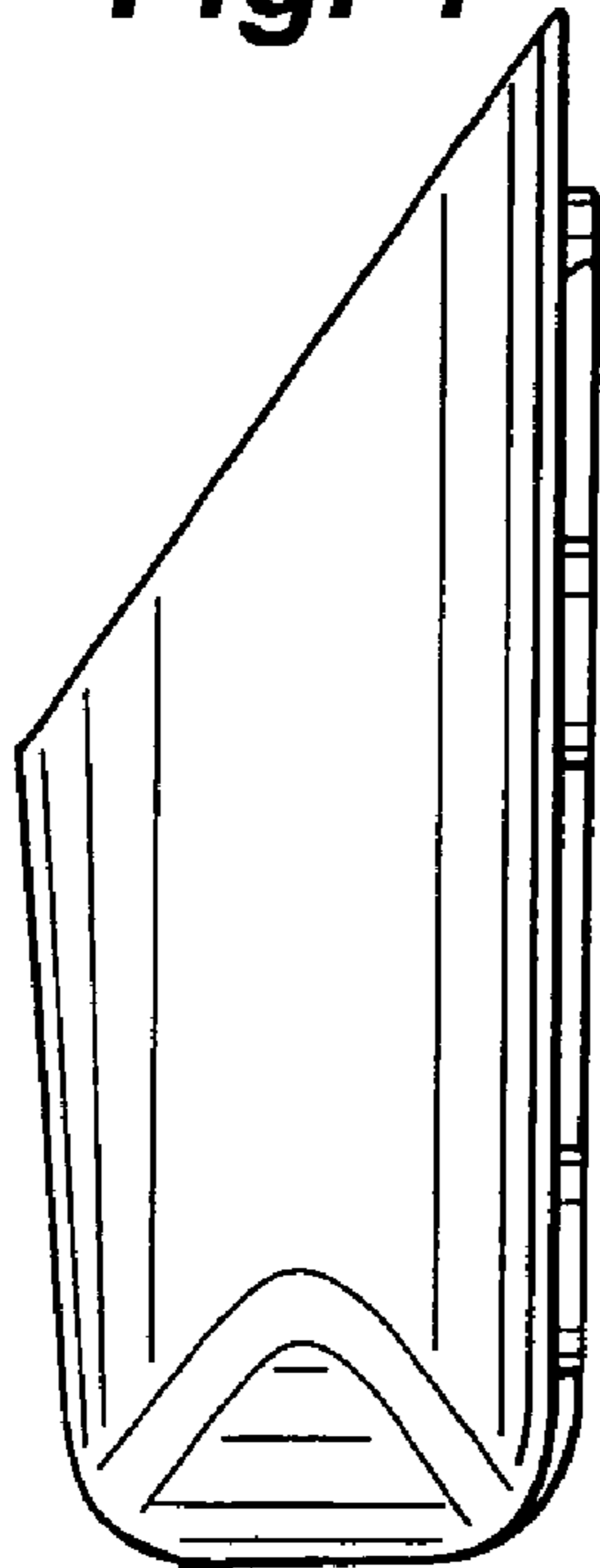

Fig. 5

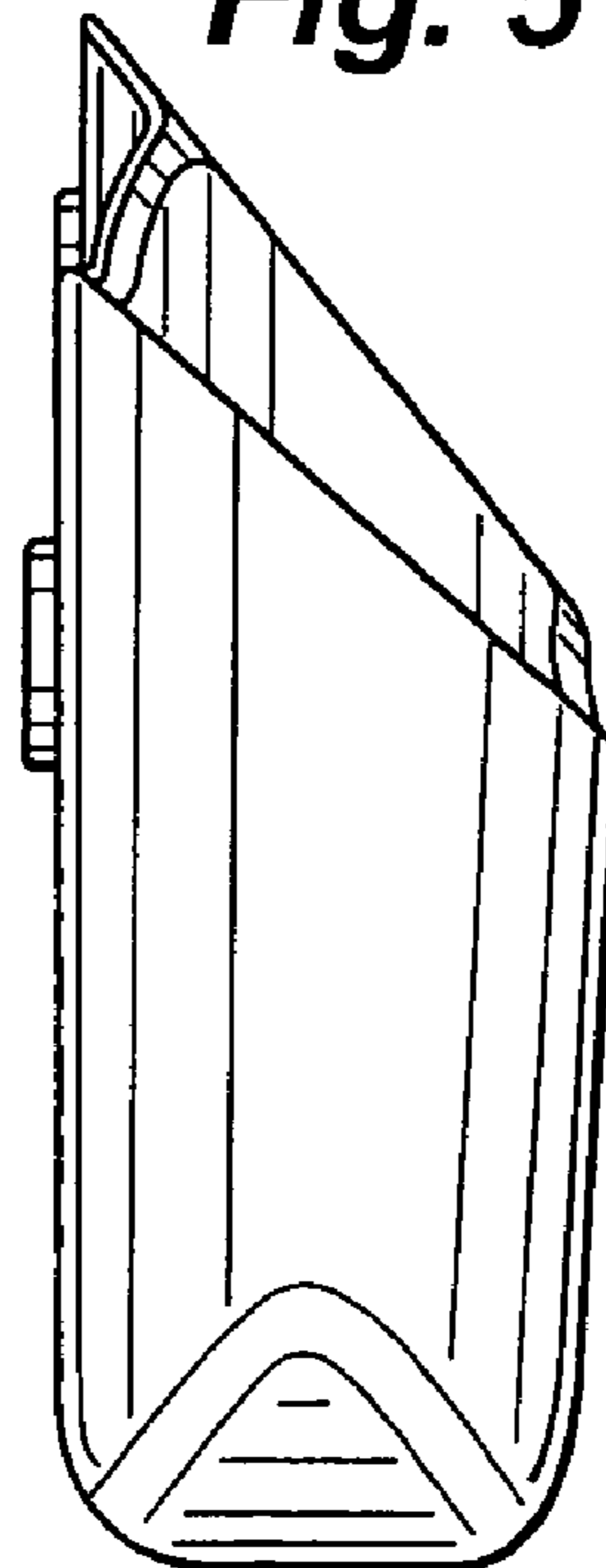

Fig. 6

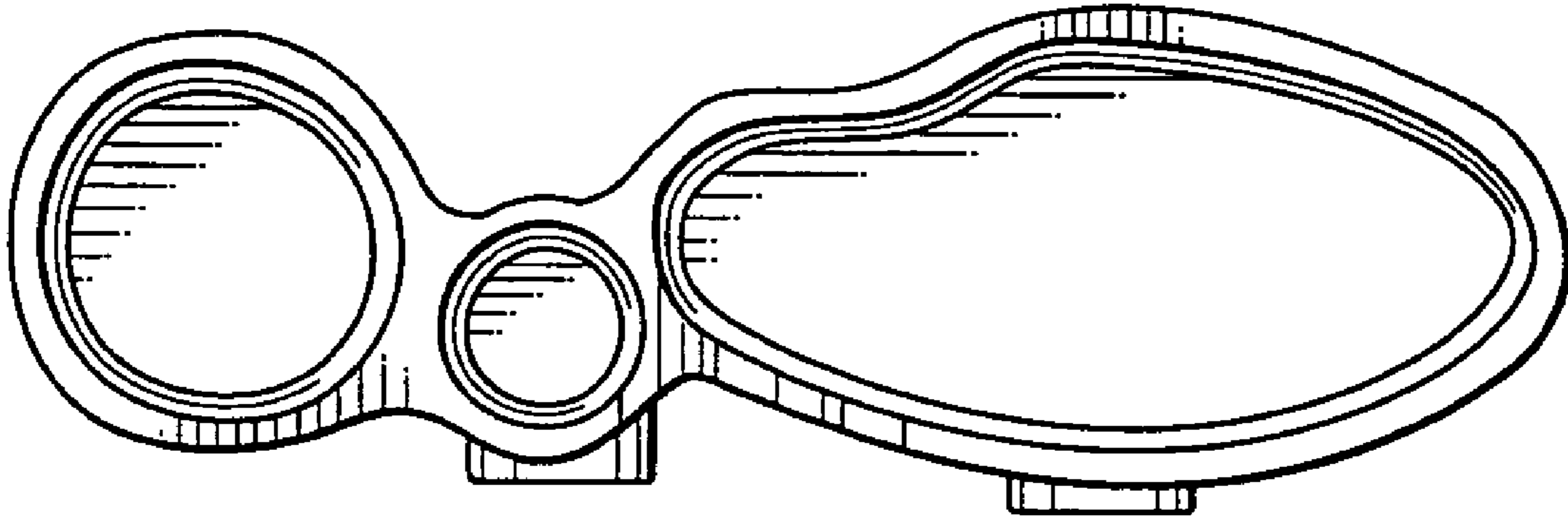

Fig. 7

