



US00D543749S

(12) **United States Design Patent**
Emmons

(10) **Patent No.:** **US D543,749 S**

(45) **Date of Patent:** **** Jun. 5, 2007**

(54) **TOOTHBRUSH HOLDING TRAY**

2003/0034315 A1 2/2003 Tayebi

(76) Inventor: **Robert S. Emmons**, 12 Copper Beech Cir., West Bridgewater, MA (US) 02379

* cited by examiner

Primary Examiner—Brian N Vinson

(**) Term: **14 Years**

(57) **CLAIM**

(21) Appl. No.: **29/230,580**

The ornamental design for a toothbrush holding tray, as shown and described.

(22) Filed: **May 25, 2005**

(51) **LOC (8) Cl.** **23-02**

(52) **U.S. Cl.** **D6/534**

(58) **Field of Classification Search** D6/534;
211/70.1, 70.7, 60.1, 70.3; 206/564
See application file for complete search history.

DESCRIPTION

FIG. 1 is a front elevational view of a toothbrush holding tray showing my new design;

FIG. 2 is a rear elevational view thereof;

FIG. 3 is a side elevational view thereof;

FIG. 4 is a top plan view thereof;

FIG. 5 is a bottom plan view thereof; and,

FIG. 6 is a perspective view thereof.

The broken lines shown on FIG. 6 are for illustrative purposes only and are hereby disclaimed as forming no part of Applicant's claimed invention.

(56) **References Cited**

U.S. PATENT DOCUMENTS

| | | | | |
|-----------|-----|---------|--------------------|----------|
| 2,463,668 | A | 3/1949 | Stephenson | |
| 3,685,660 | A * | 8/1972 | Saunders | 211/70.1 |
| D283,961 | S * | 5/1986 | Doyle | D6/534 |
| D291,268 | S * | 8/1987 | Stephenson | D6/534 |
| 4,995,515 | A | 2/1991 | Smith | |
| 5,960,801 | A | 10/1999 | Vermooten et al. | |
| 6,343,700 | B1 | 2/2002 | Slendebrook et al. | |

1 Claim, 2 Drawing Sheets

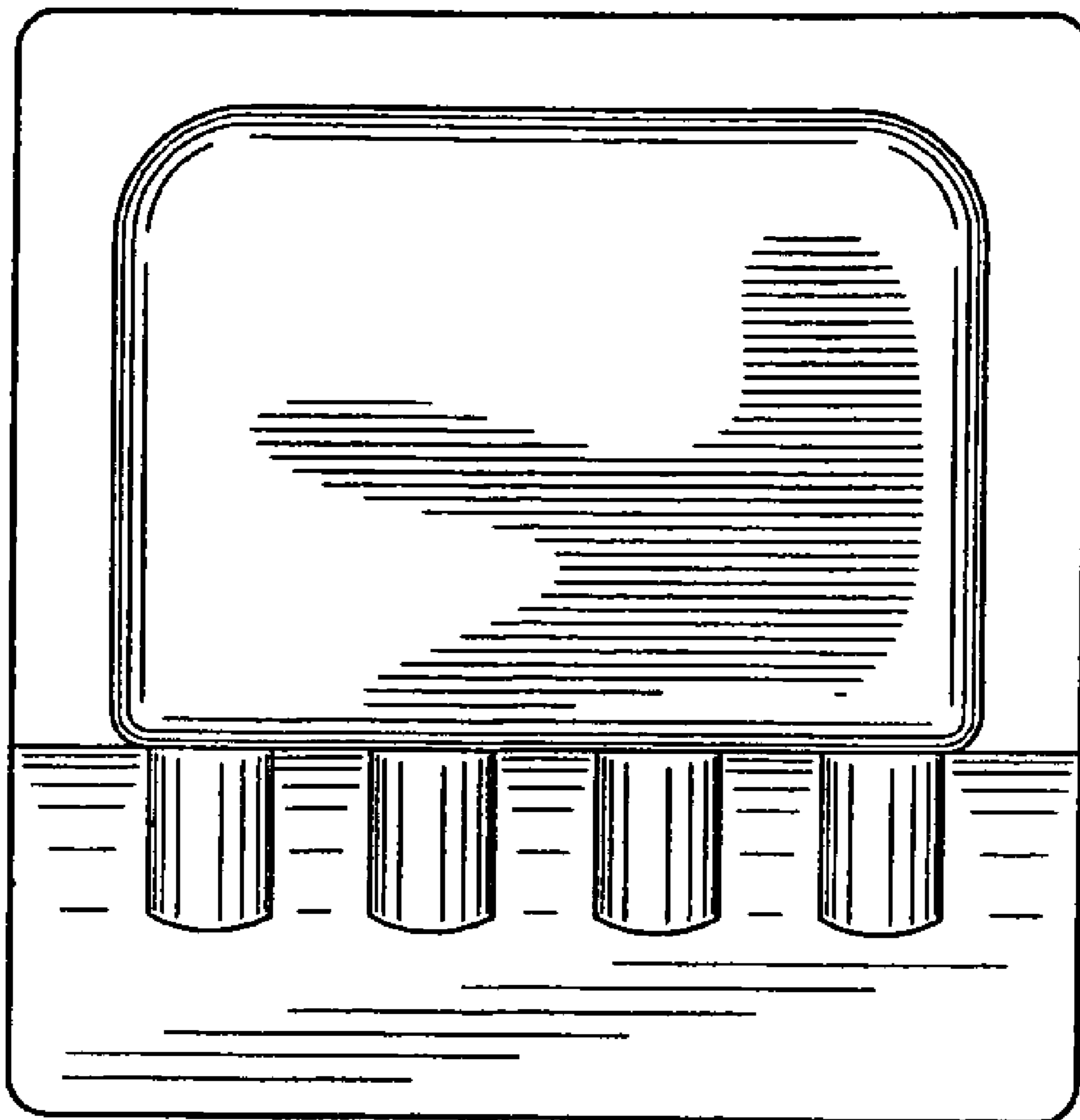

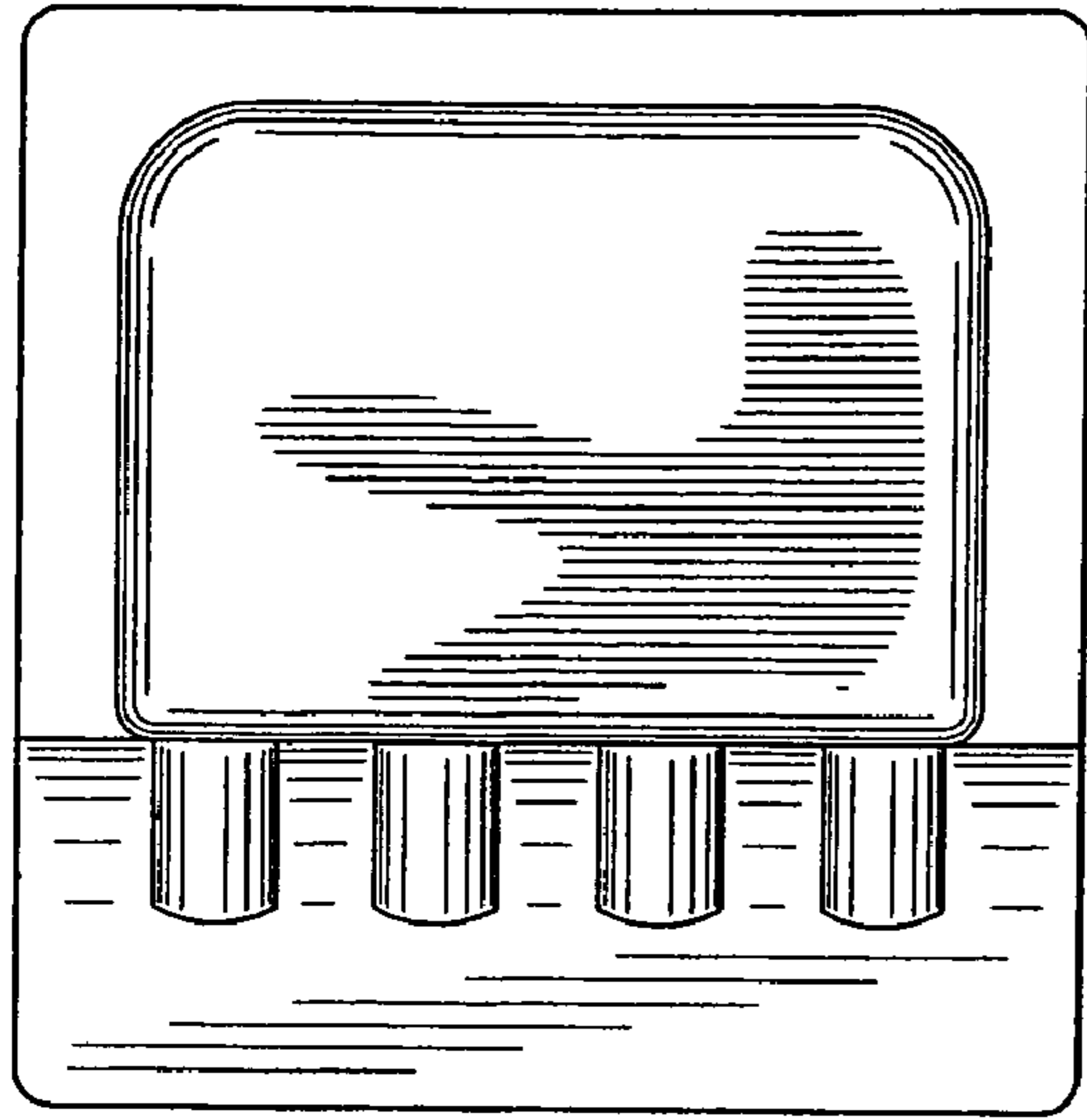

FIG. 1

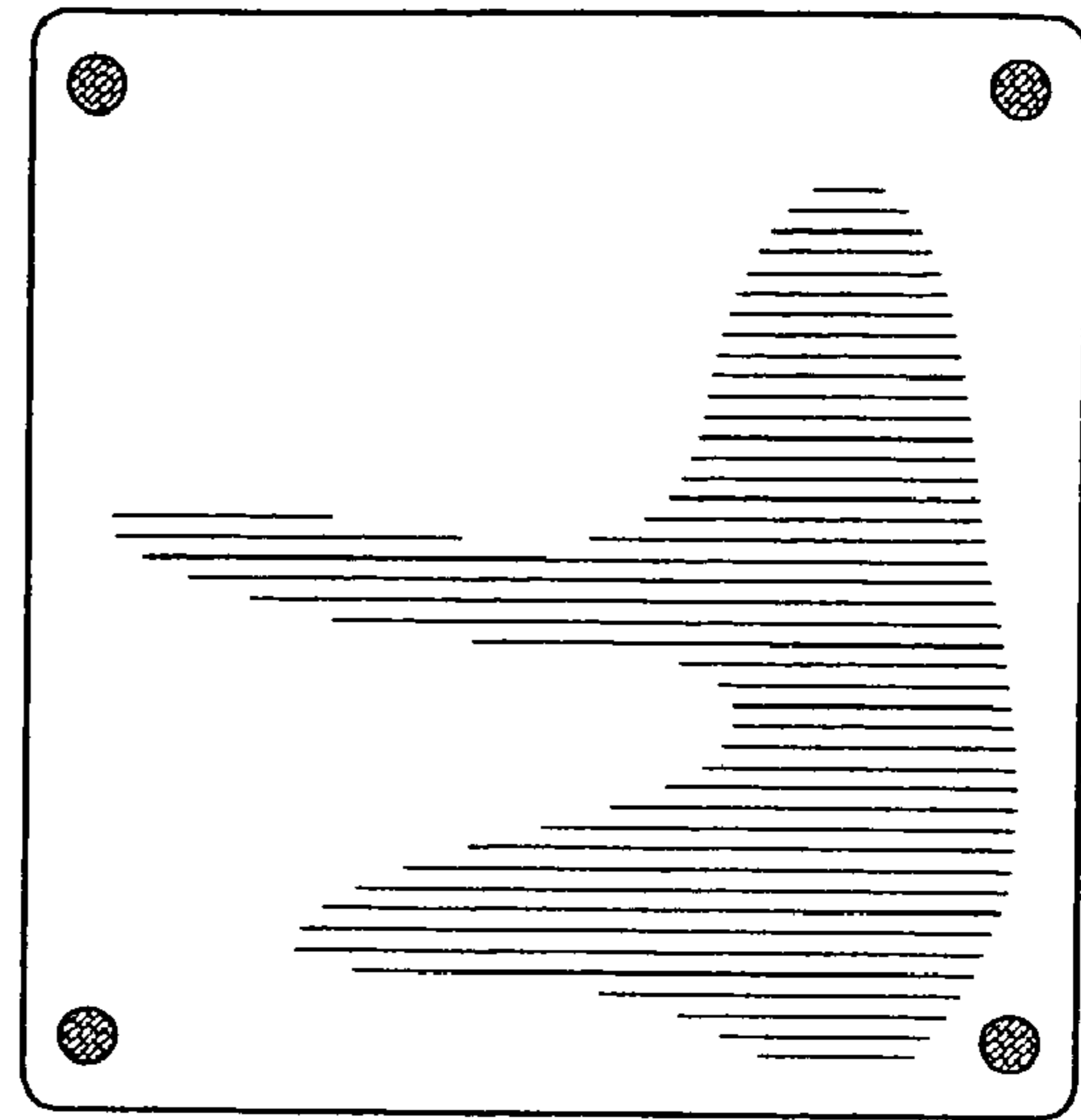

FIG. 2

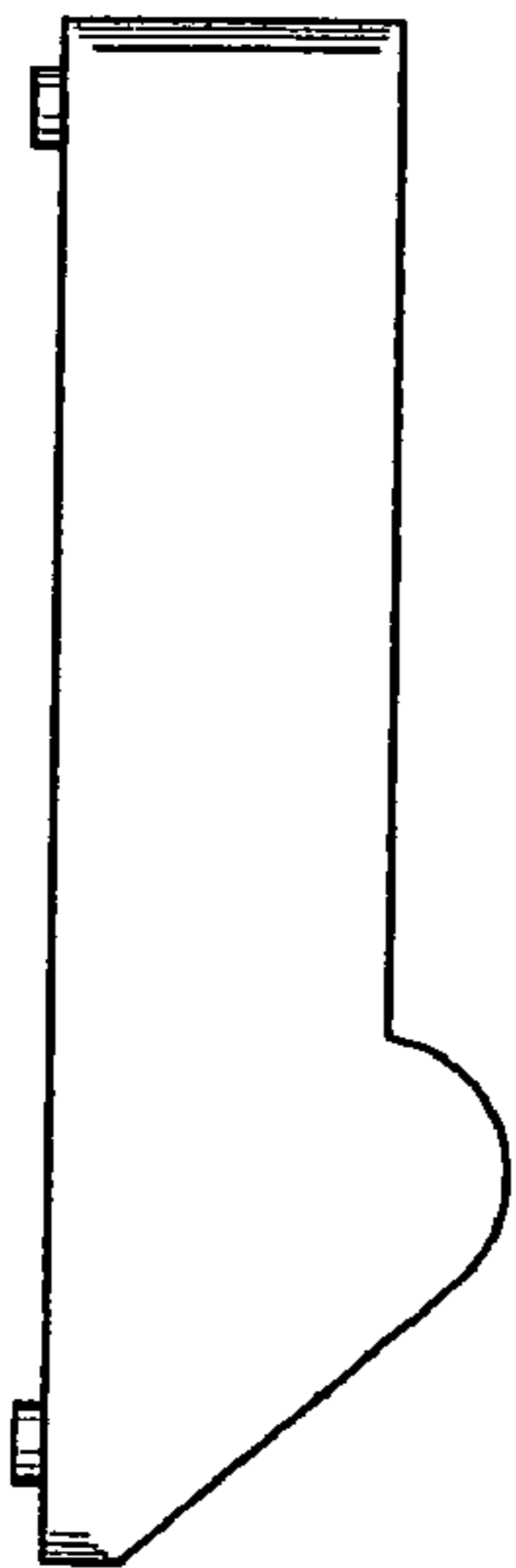

FIG. 3

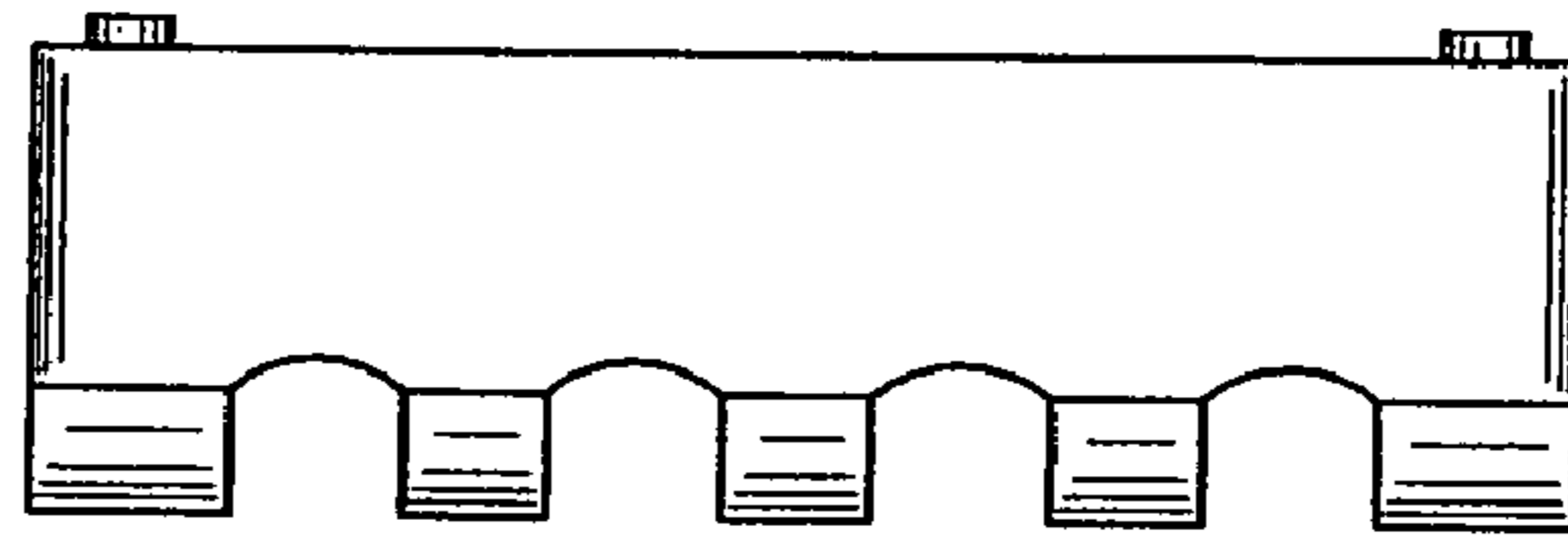

FIG. 4

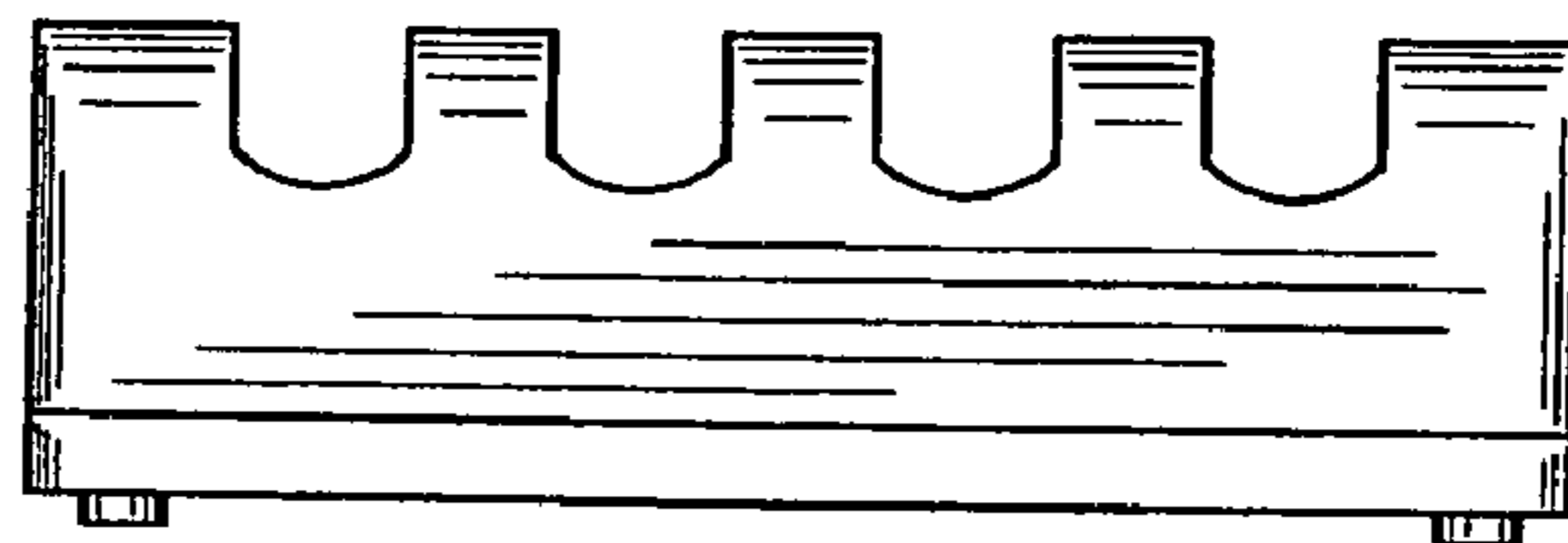

FIG. 5

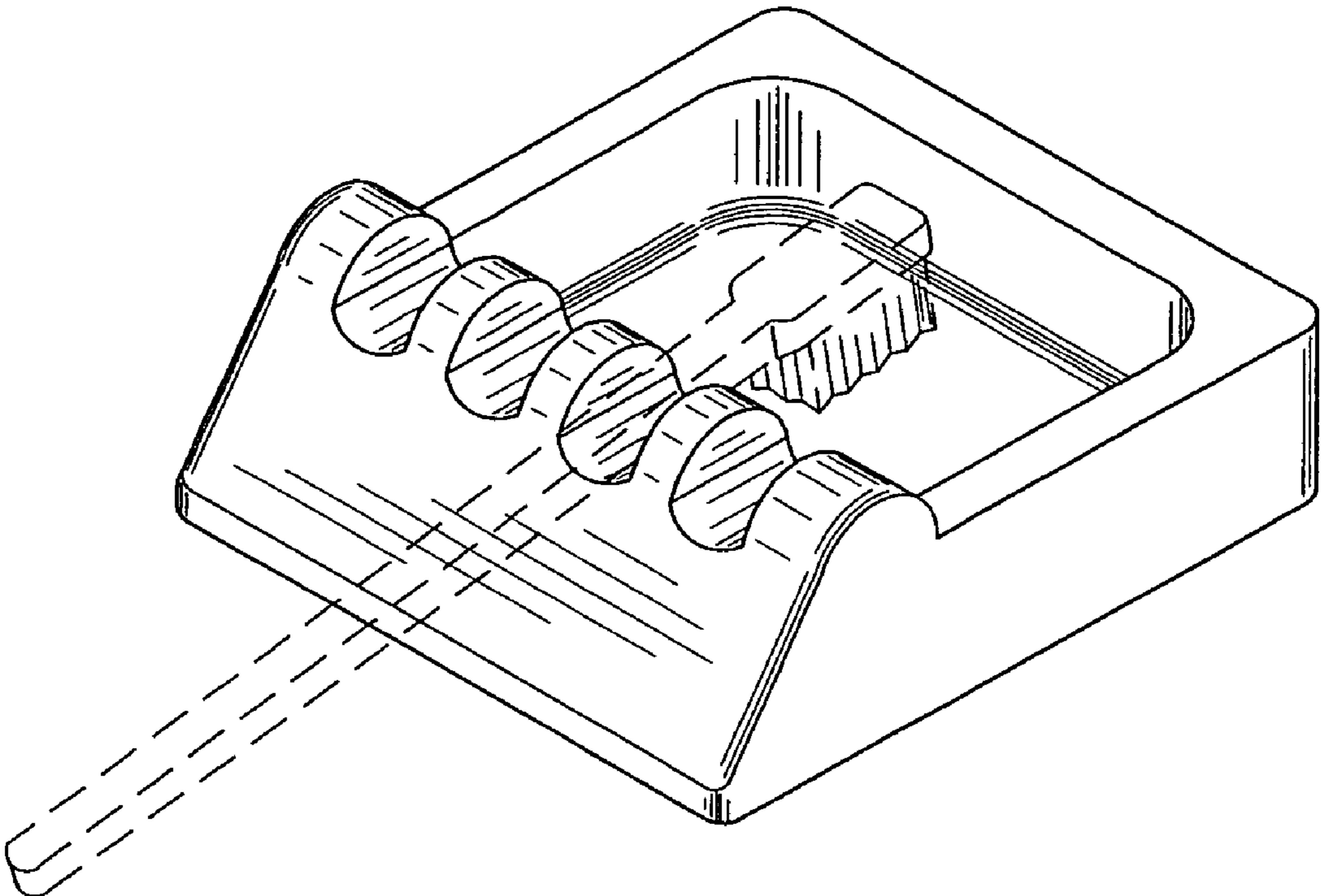

FIG. 6