



US00D543739S

(12) **United States Design Patent**
Catton

(10) **Patent No.:** **US D543,739 S**

(45) **Date of Patent:** **** Jun. 5, 2007**

(54) **PORTABLE BACKREST**

(76) Inventor: **Kevin Catton**, R.R. #1, Breslau,
Ontario (CA) N0B 1M0

(**) Term: **14 Years**

(21) Appl. No.: **29/240,148**

(22) Filed: **Oct. 11, 2005**

(51) **LOC (8) Cl.** **06-06**

(52) **U.S. Cl.** **D6/502**

(58) **Field of Classification Search** D6/334-336,
D6/360, 366, 370, 374, 375, 376, 379, 380,
D6/500-502; 297/352, 452.1, 452.36, 452.42,
297/452.46

See application file for complete search history.

(56) **References Cited**

U.S. PATENT DOCUMENTS

D76,151 S *	8/1928	Racz	D6/366
2,412,112 A *	12/1946	Wood et al.	297/452.42
D174,592 S *	4/1955	Pettibone	D6/379
D232,145 S *	7/1974	Armbuster	D6/502
D257,473 S *	11/1980	Wilson	D6/360
D304,400 S *	11/1989	Schultz	D6/502
5,884,971 A *	3/1999	Davis et al.	297/352
D433,855 S *	11/2000	Turner et al.	D6/502
D463,177 S *	9/2002	Li	D6/502

* cited by examiner

Primary Examiner—Mimosa De

(57) **CLAIM**

The ornamental design for a portable backrest, as shown and described.

DESCRIPTION

FIG. 1 is a perspective view of a front side of the portable backrest;

FIG. 2 is a side view showing a first side thereof;

FIG. 3 is a front view thereof;

FIG. 4 is a side view showing a second side thereof;

FIG. 5 is a back view thereof;

FIG. 6 is a top view thereof;

FIG. 7 is a bottom view thereof;

FIG. 8 is a perspective reduced view of the front side thereof showing the portable backrest mounted on a tree;

FIG. 9 is a perspective view of a front side of an alternative embodiment of the portable backrest;

FIG. 10 is a side view showing a first side thereof;

FIG. 11 is a front view thereof;

FIG. 12 is a side view showing a second side thereof;

FIG. 13 is a back view thereof;

FIG. 14 is a top view thereof; and,

FIG. 15 is a bottom view thereof.

The broken lines in FIG. 8 showing environment are for illustrative purposes only and form no part of the claimed design.

1 Claim, 11 Drawing Sheets

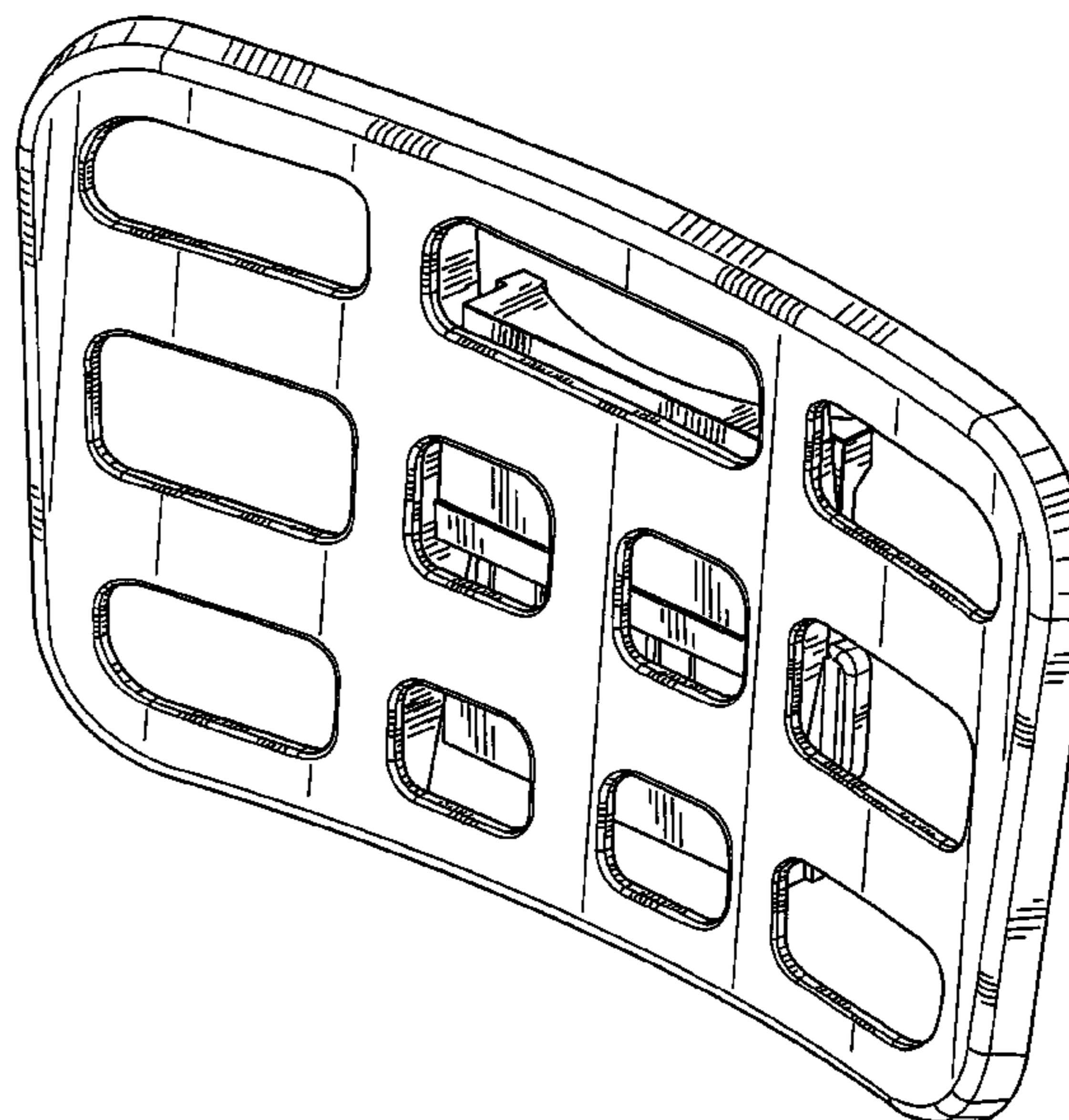
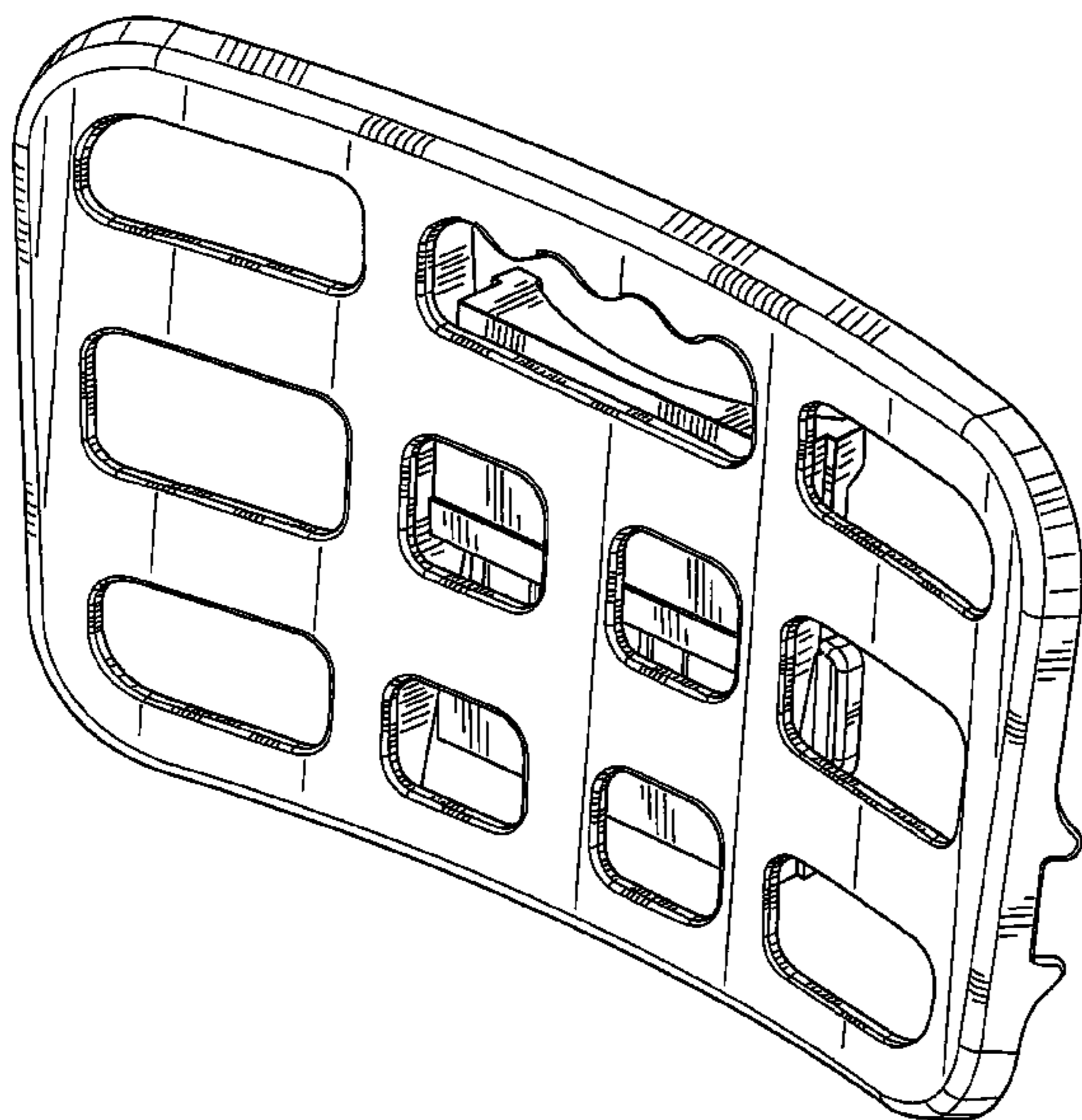

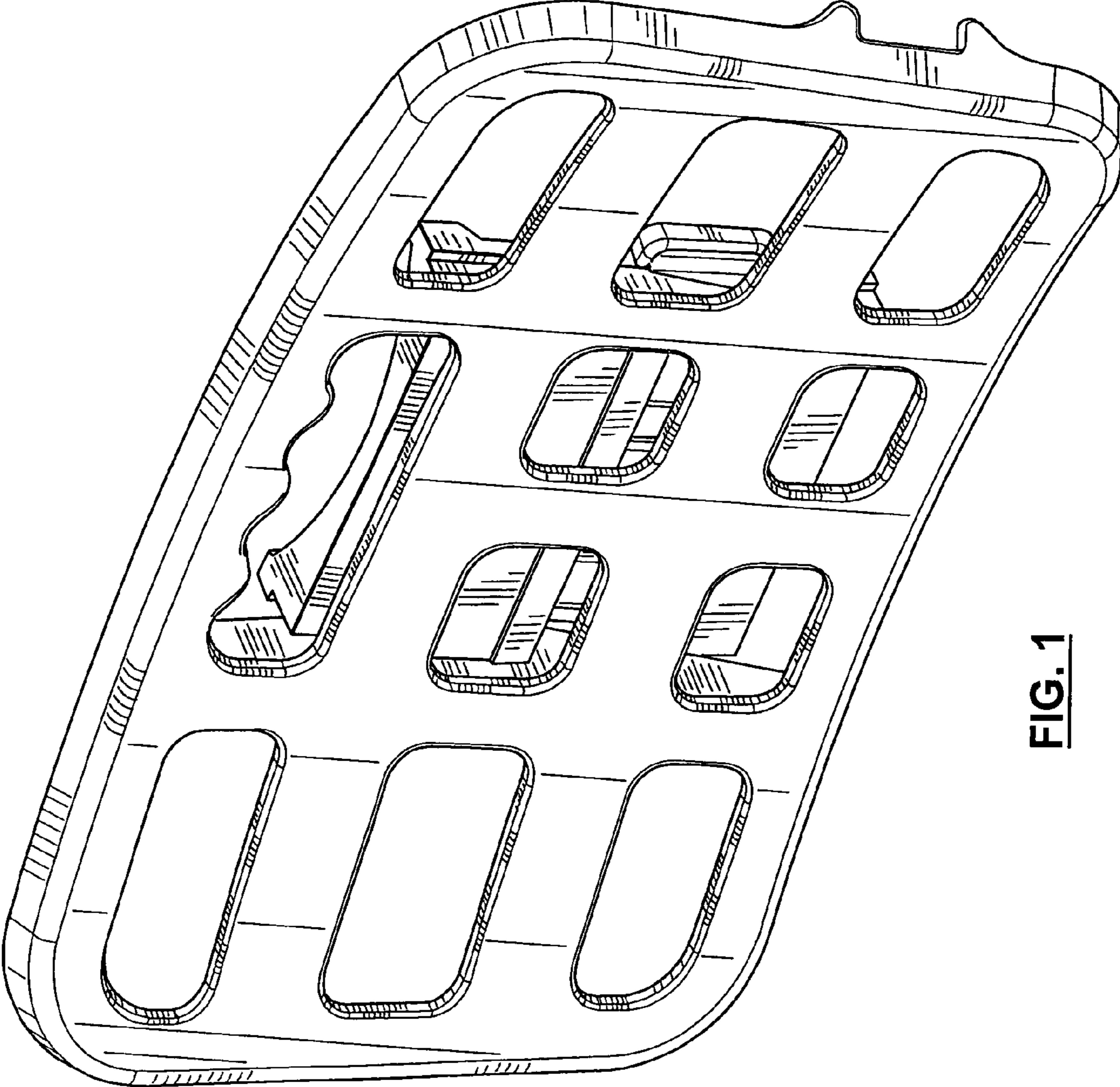

FIG. 1

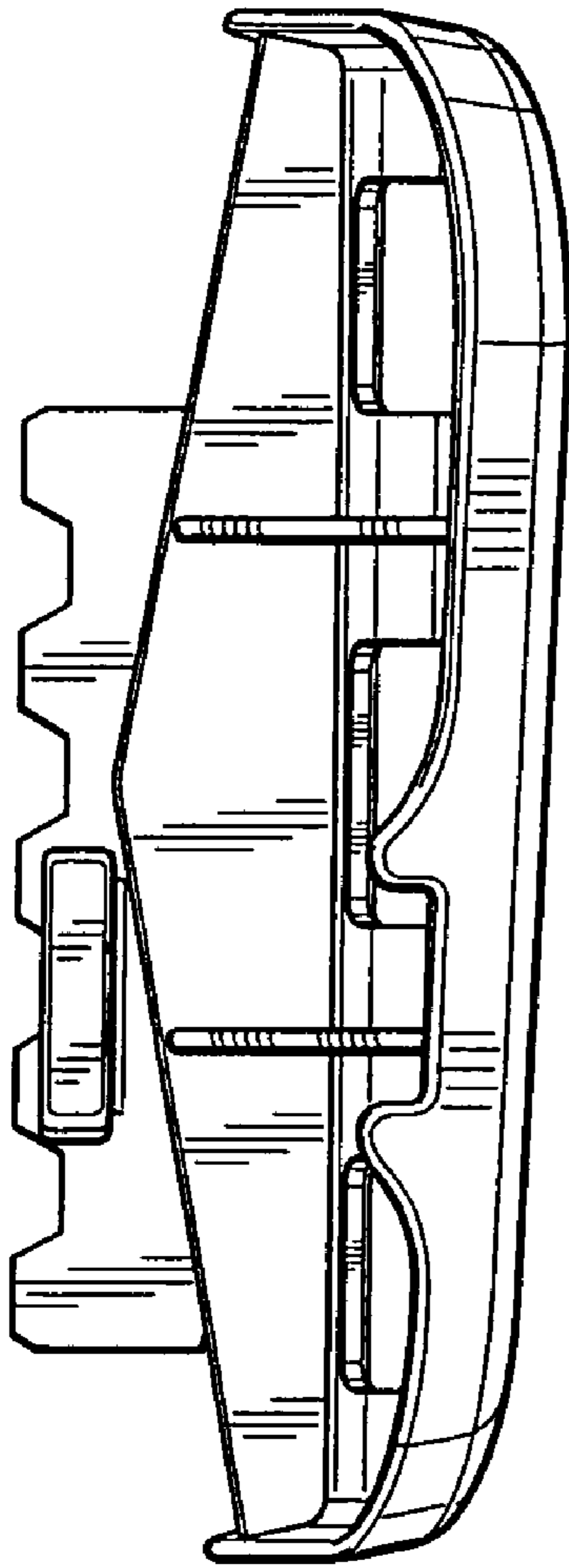

FIG. 2

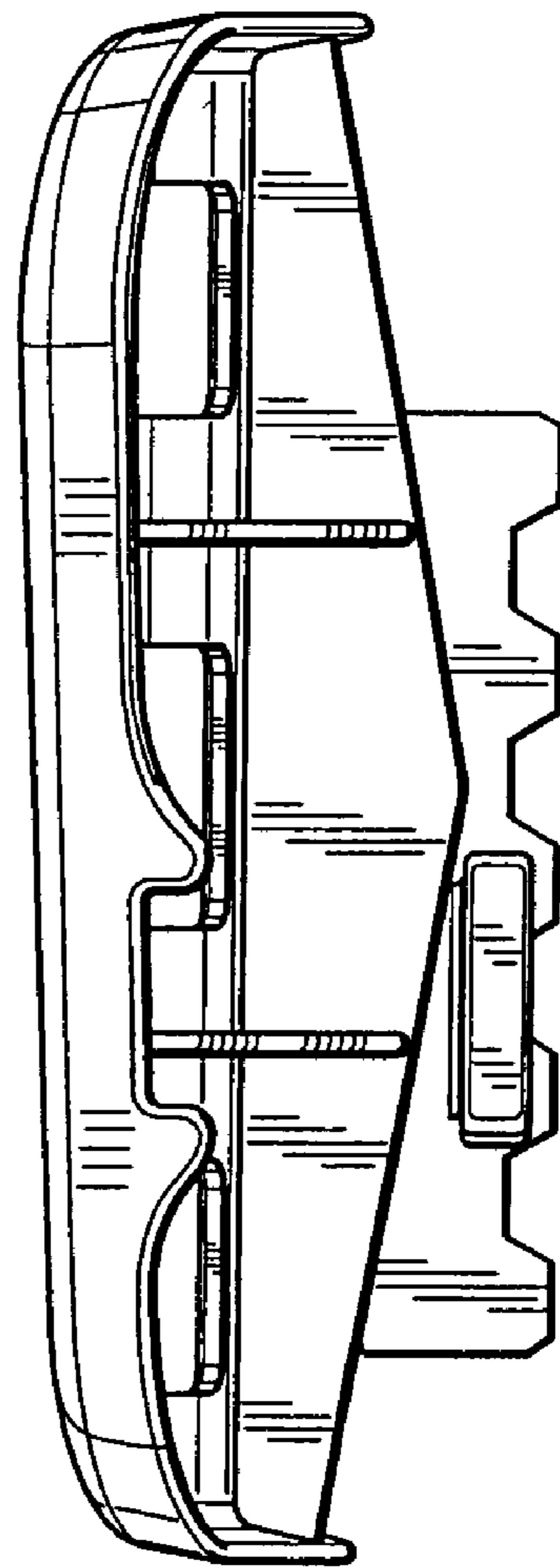

FIG. 4

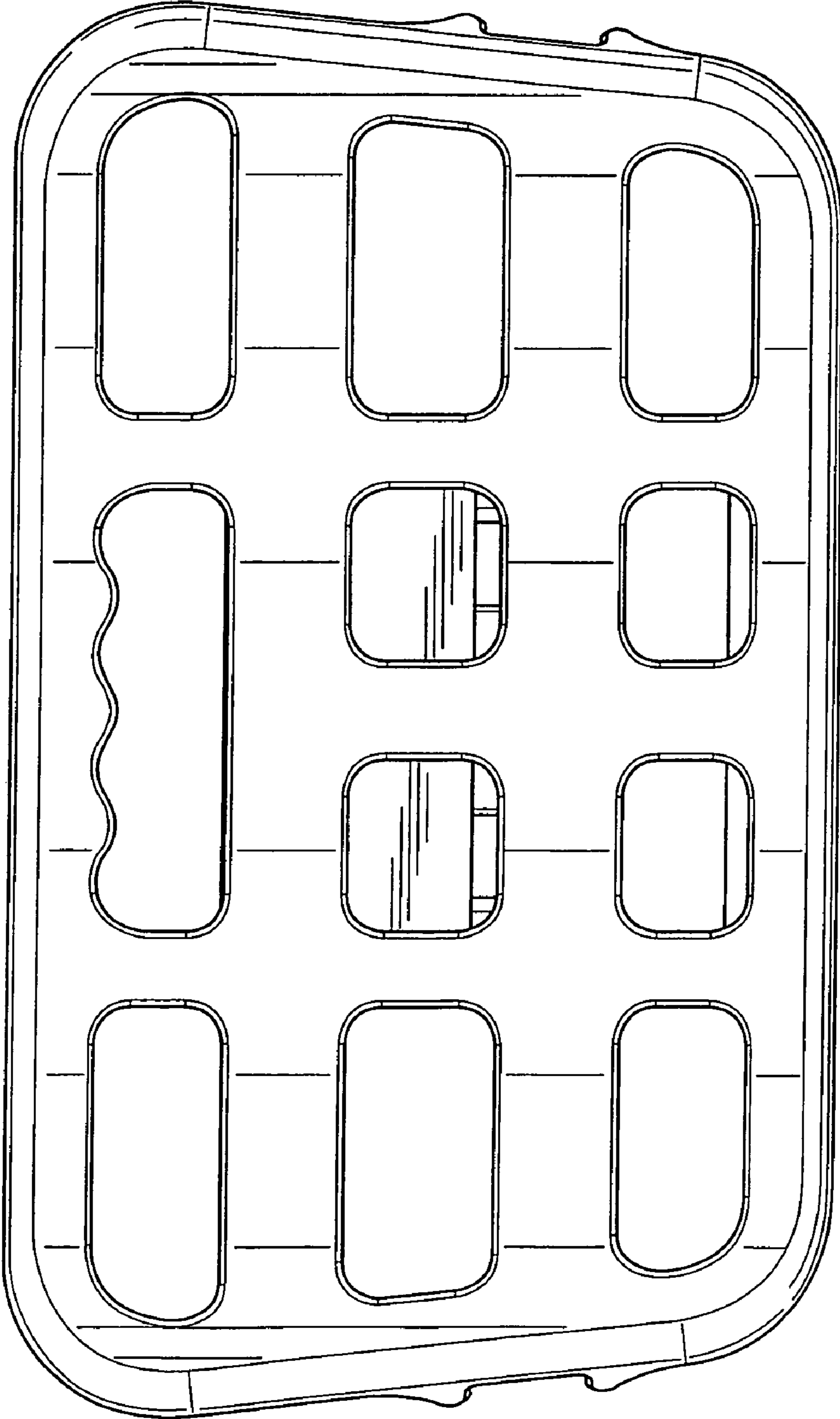

FIG. 3

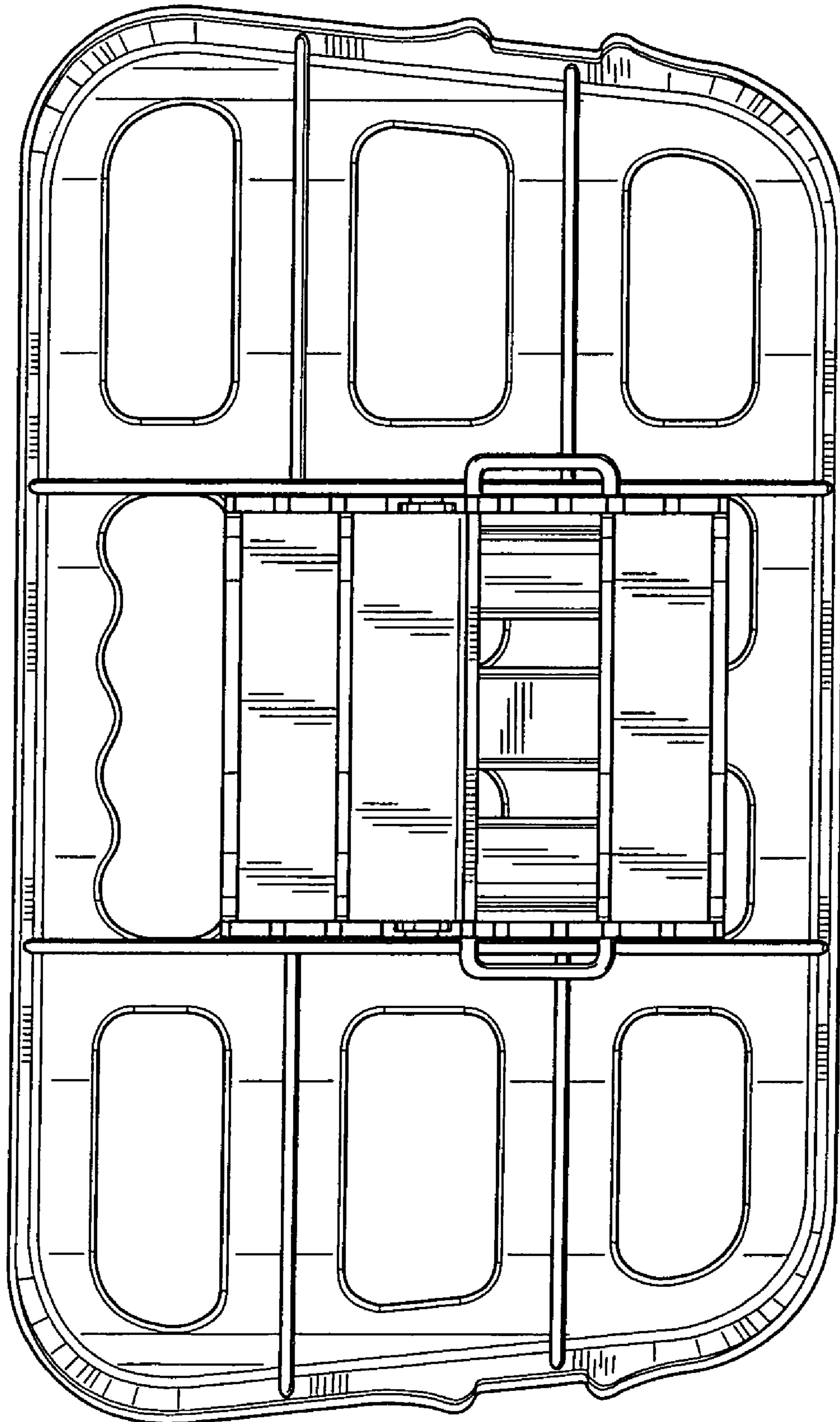

FIG. 5

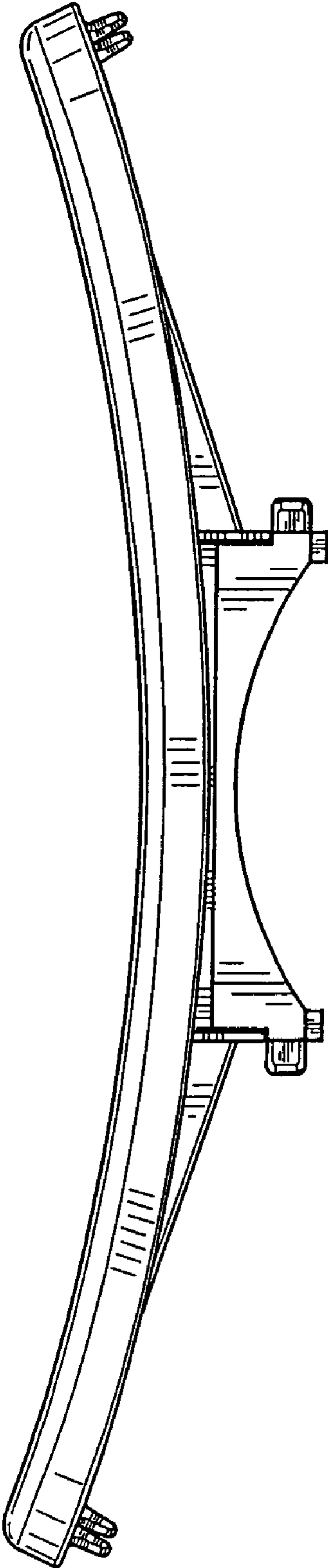

FIG. 6

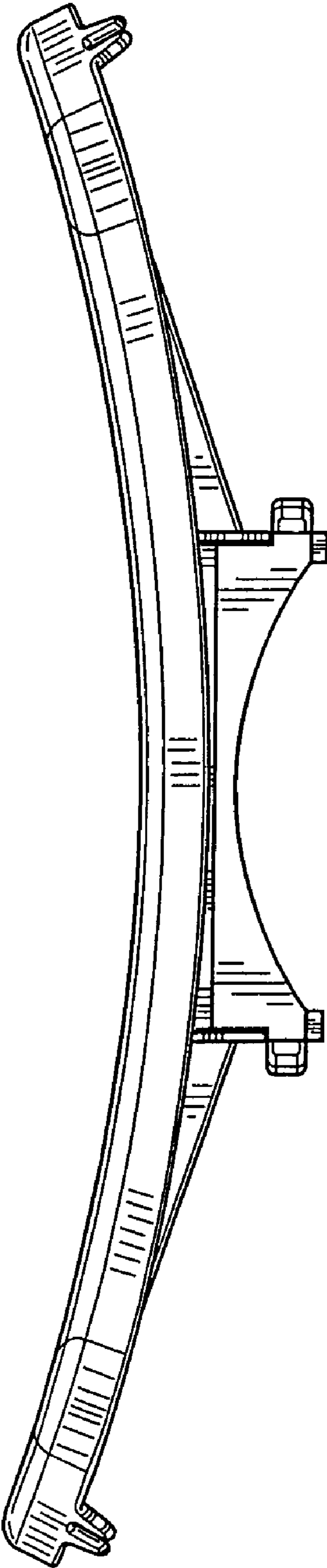

FIG. 7

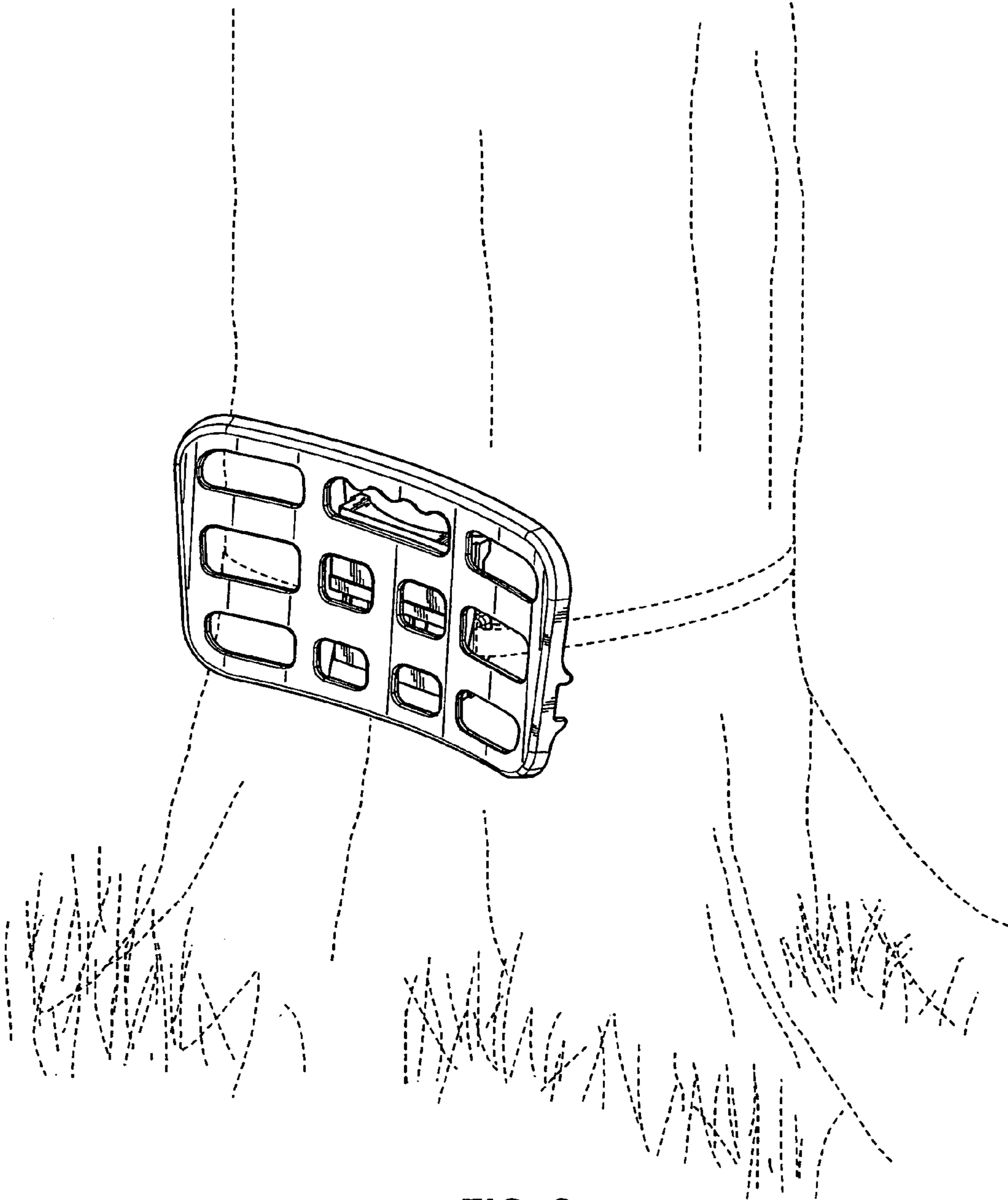

FIG. 8

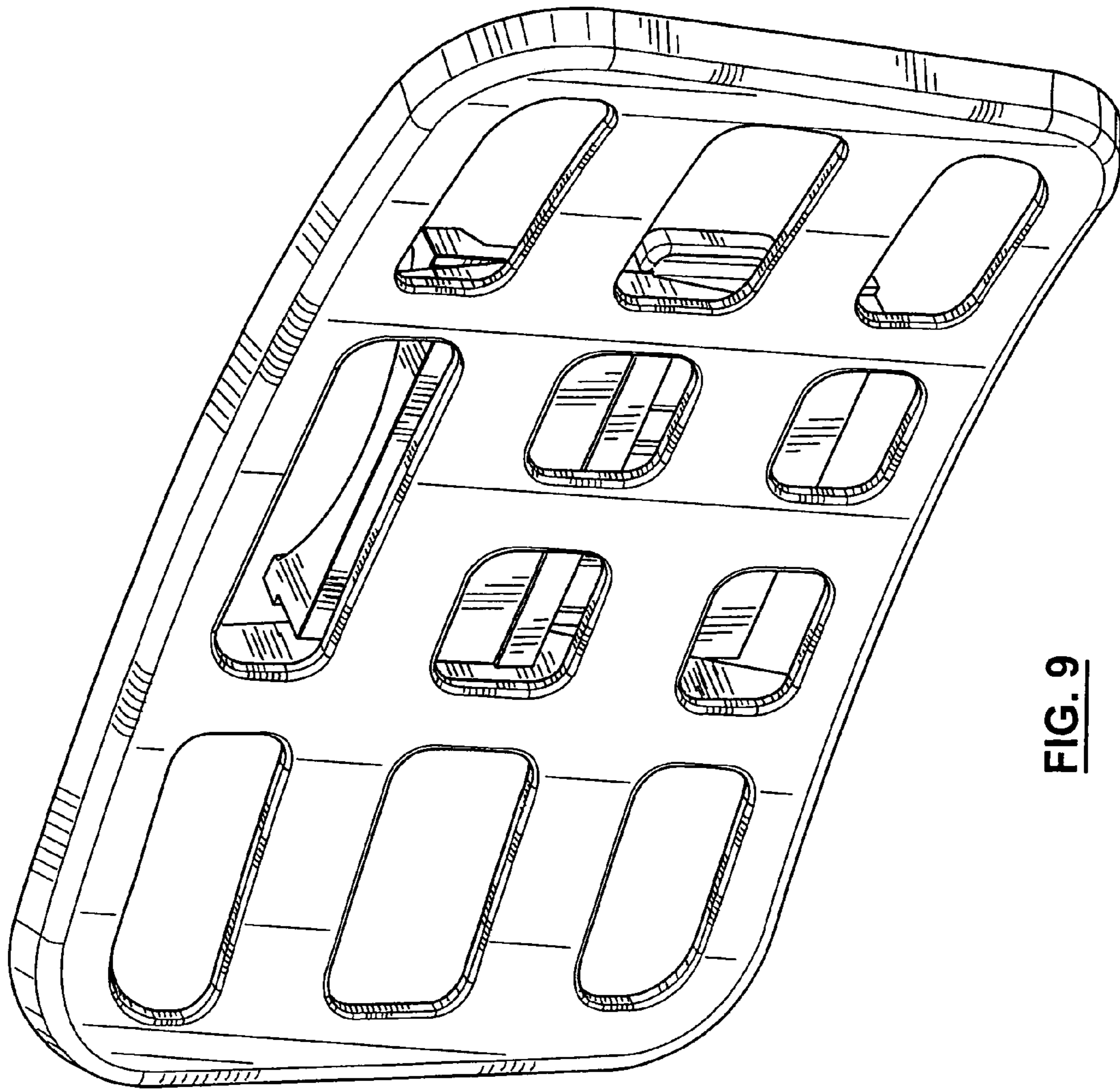

FIG. 9

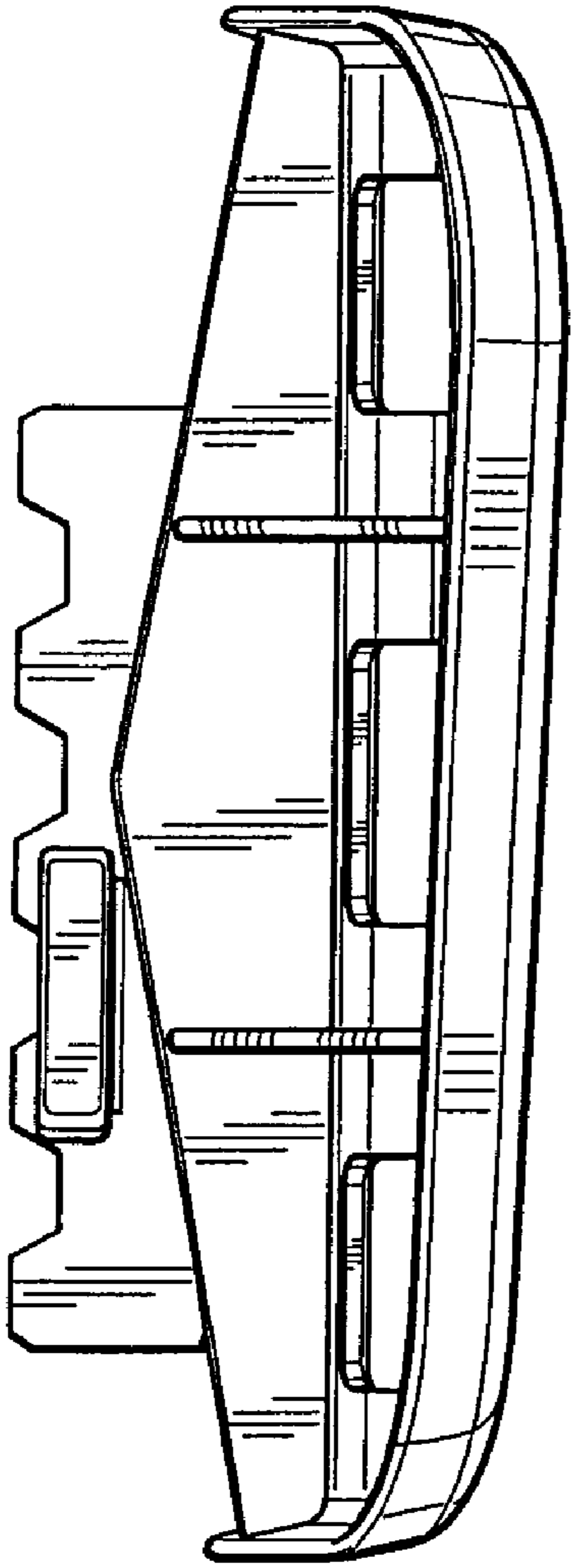

FIG. 10

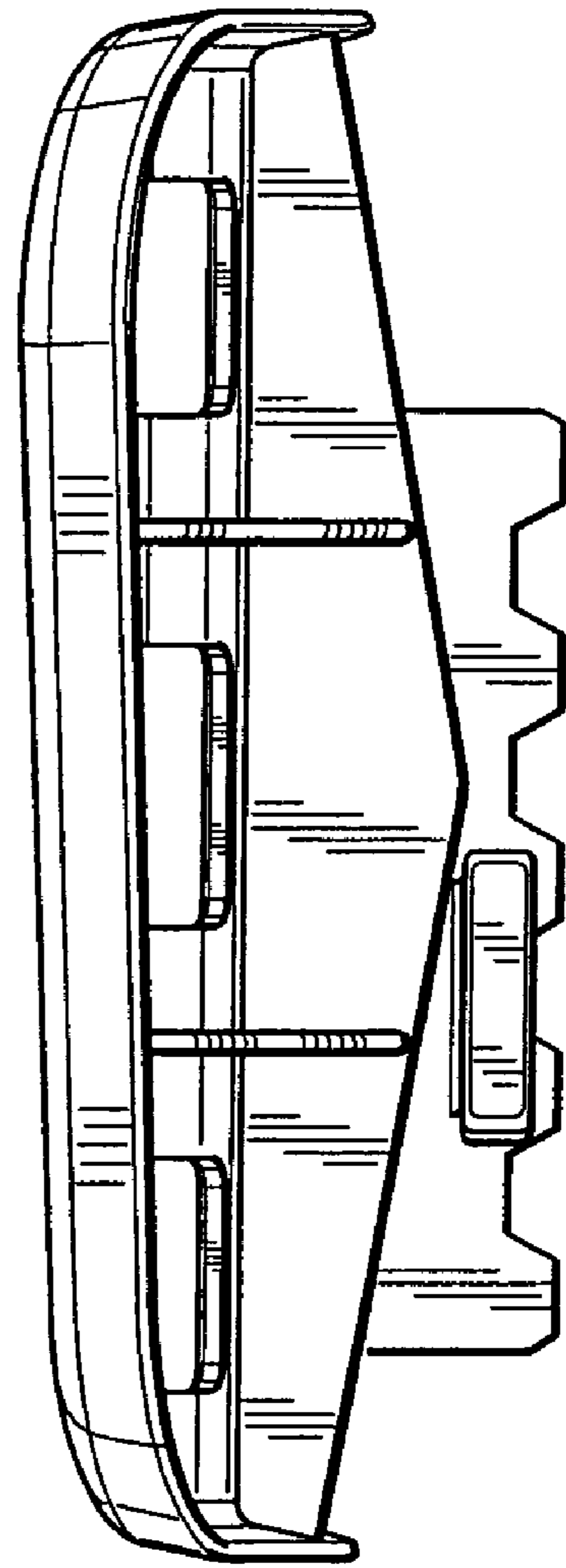

FIG. 12

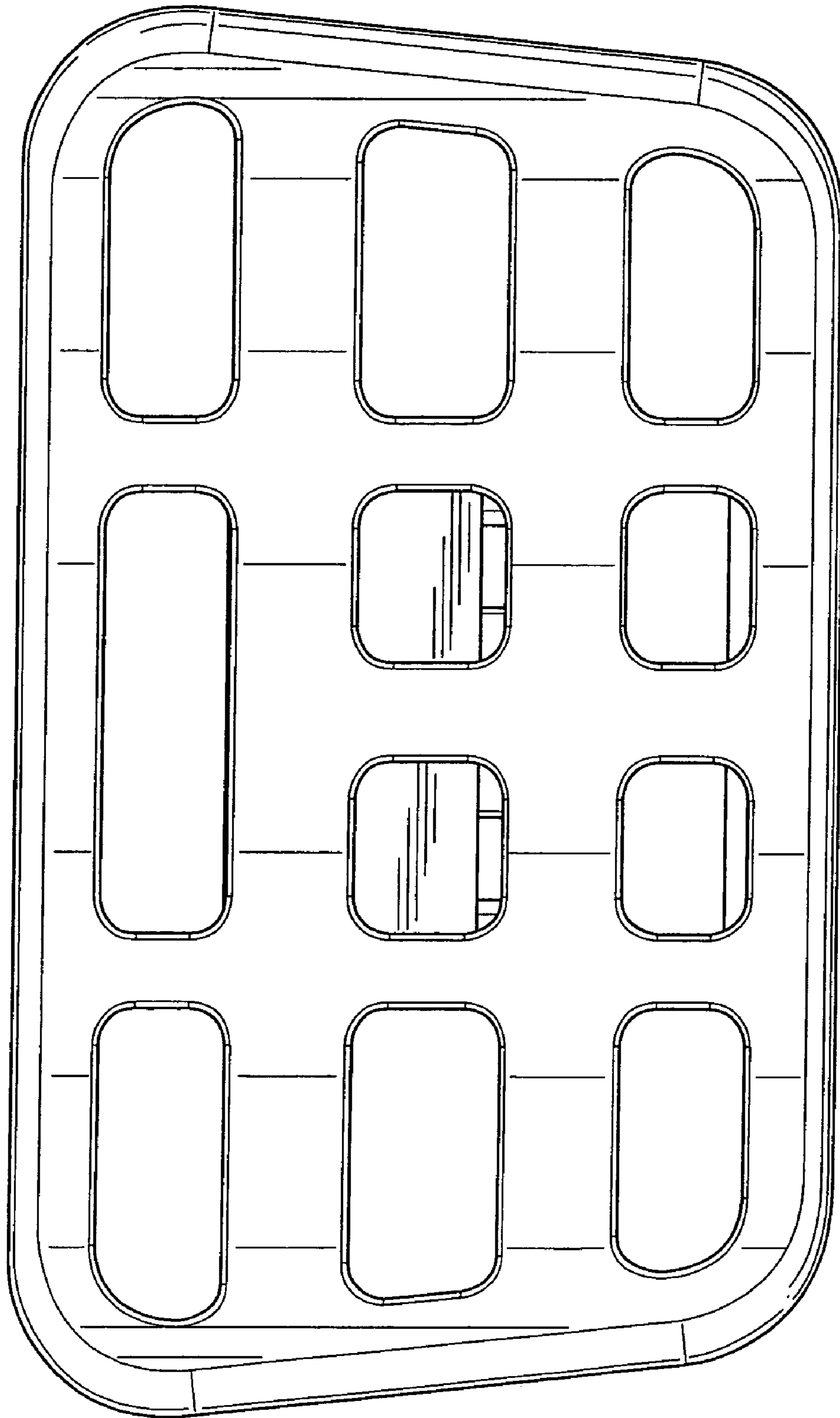

FIG. 11

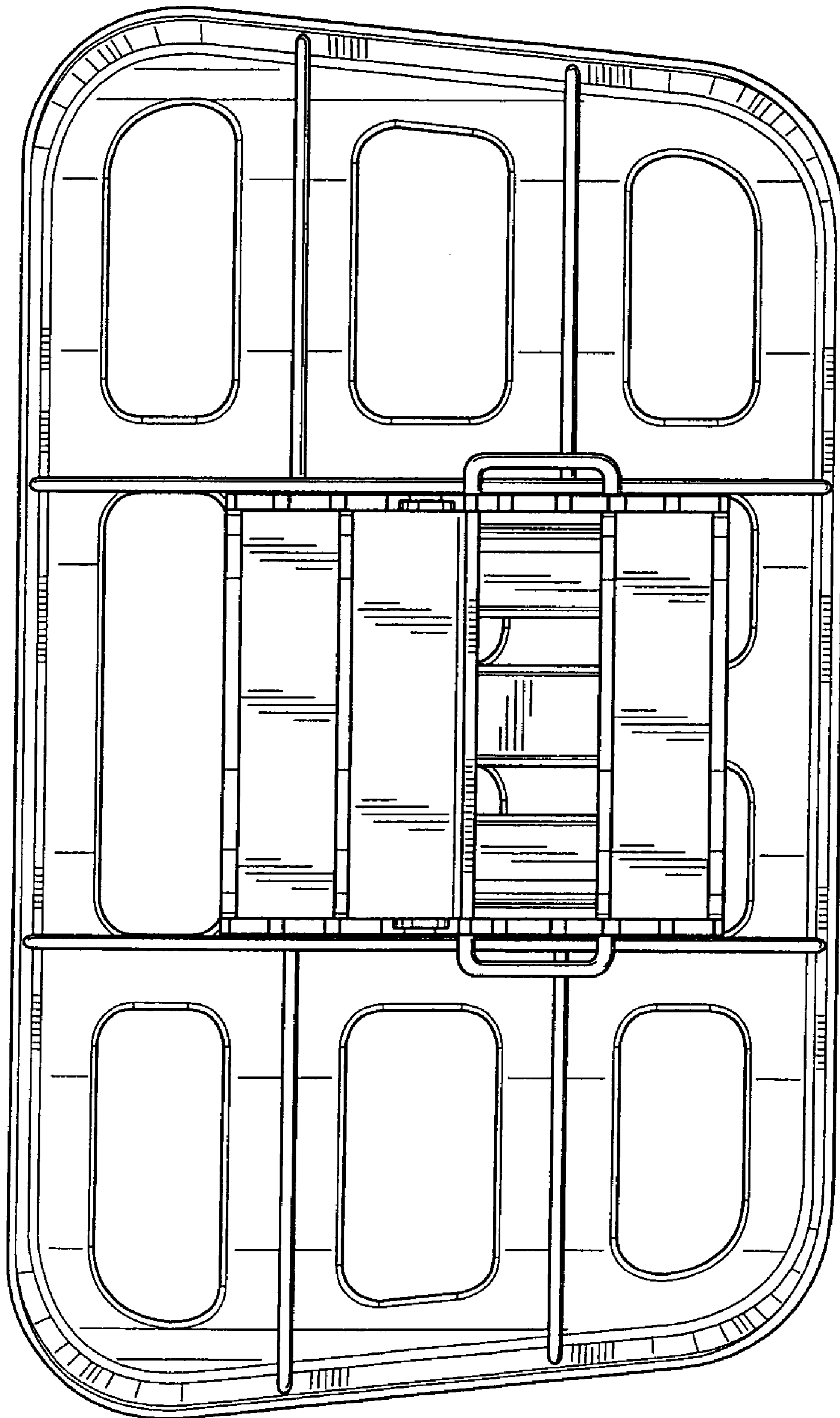

FIG. 13

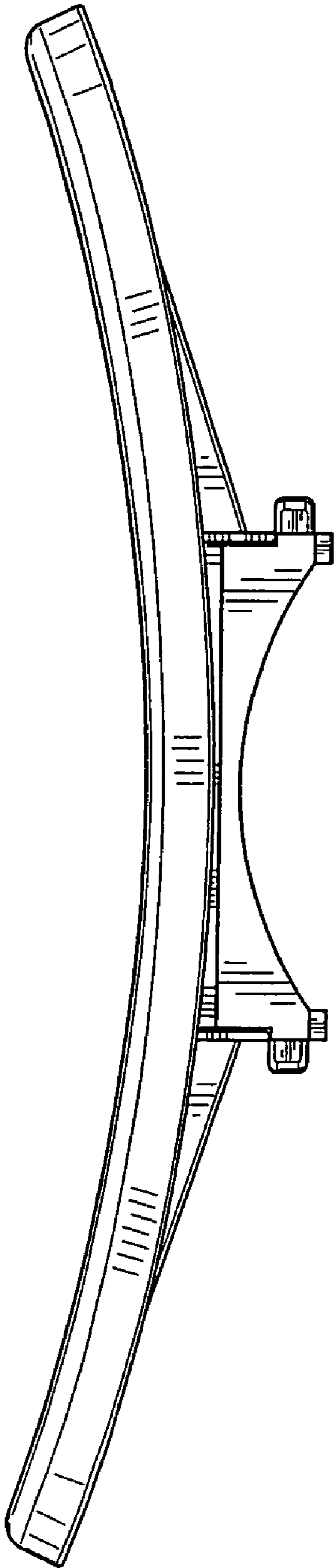

FIG. 14

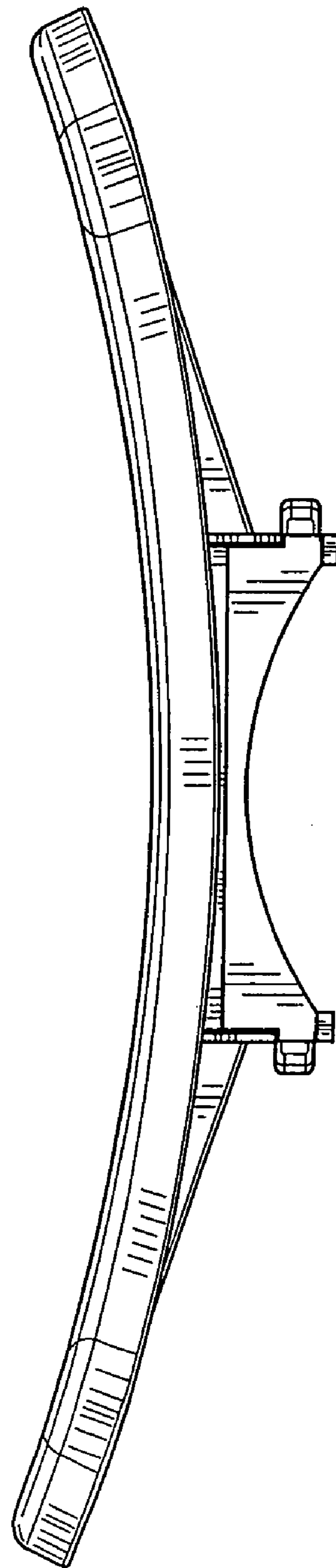

FIG. 15