



US00D543616S

(12) **United States Design Patent**  
**Yang**

(10) **Patent No.:** **US D543,616 S**

(45) **Date of Patent:** **\*\* May 29, 2007**

(54) **COMBINED CEILING FAN MOTOR HOUSING AND LIGHT KIT**

D522,135 S \* 5/2006 Hidalgo ..... D23/411  
D526,406 S \* 8/2006 Hidalgo ..... D23/411  
D530,811 S \* 10/2006 Ertze ..... D23/411

(75) Inventor: **Sam Yang**, Huizhou (CN)

\* cited by examiner

(73) Assignee: **Landmark Enterprise Inc.**, Begawan (BN)

*Primary Examiner*—Lisa Lichtenstein

(74) *Attorney, Agent, or Firm*—Troxell Law Office, PLLC

(\*\*) Term: **14 Years**

(57) **CLAIM**

(21) Appl. No.: **29/261,554**

I claim the ornamental design for a combined ceiling fan motor housing and light kit, as shown and described.

(22) Filed: **Jun. 16, 2006**

**DESCRIPTION**

(51) **LOC (8) Cl.** ..... **23-04**

(52) **U.S. Cl.** ..... **D23/411**

(58) **Field of Classification Search** ..... D23/411,  
D23/413, 377, 379, 385; 416/5; D26/59,  
D26/72, 81–88, 51

See application file for complete search history.

FIG. 1 is a front perspective view of a combined ceiling fan motor housing and light kit showing my new design; FIG. 2 is a front elevational view thereof; FIG. 3 is a rear elevational view thereof; FIG. 4 is a left side elevational view thereof; FIG. 5 is a right side elevational view thereof; FIG. 6 is a top plan view thereof; and, FIG. 7 is a bottom plan view thereof.

(56) **References Cited**

**U.S. PATENT DOCUMENTS**

D363,540 S \* 10/1995 Yen ..... D23/411

**1 Claim, 7 Drawing Sheets**

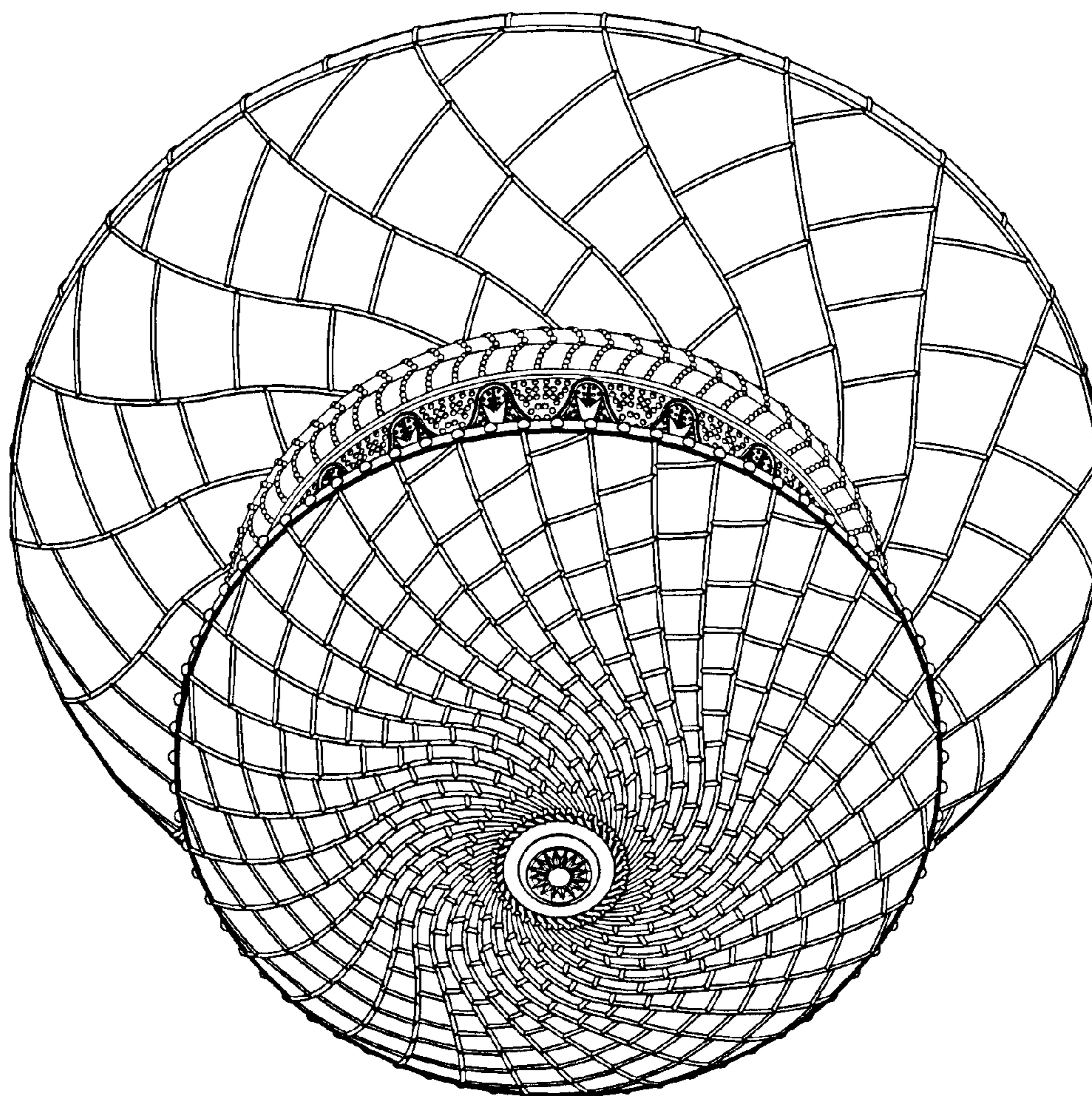

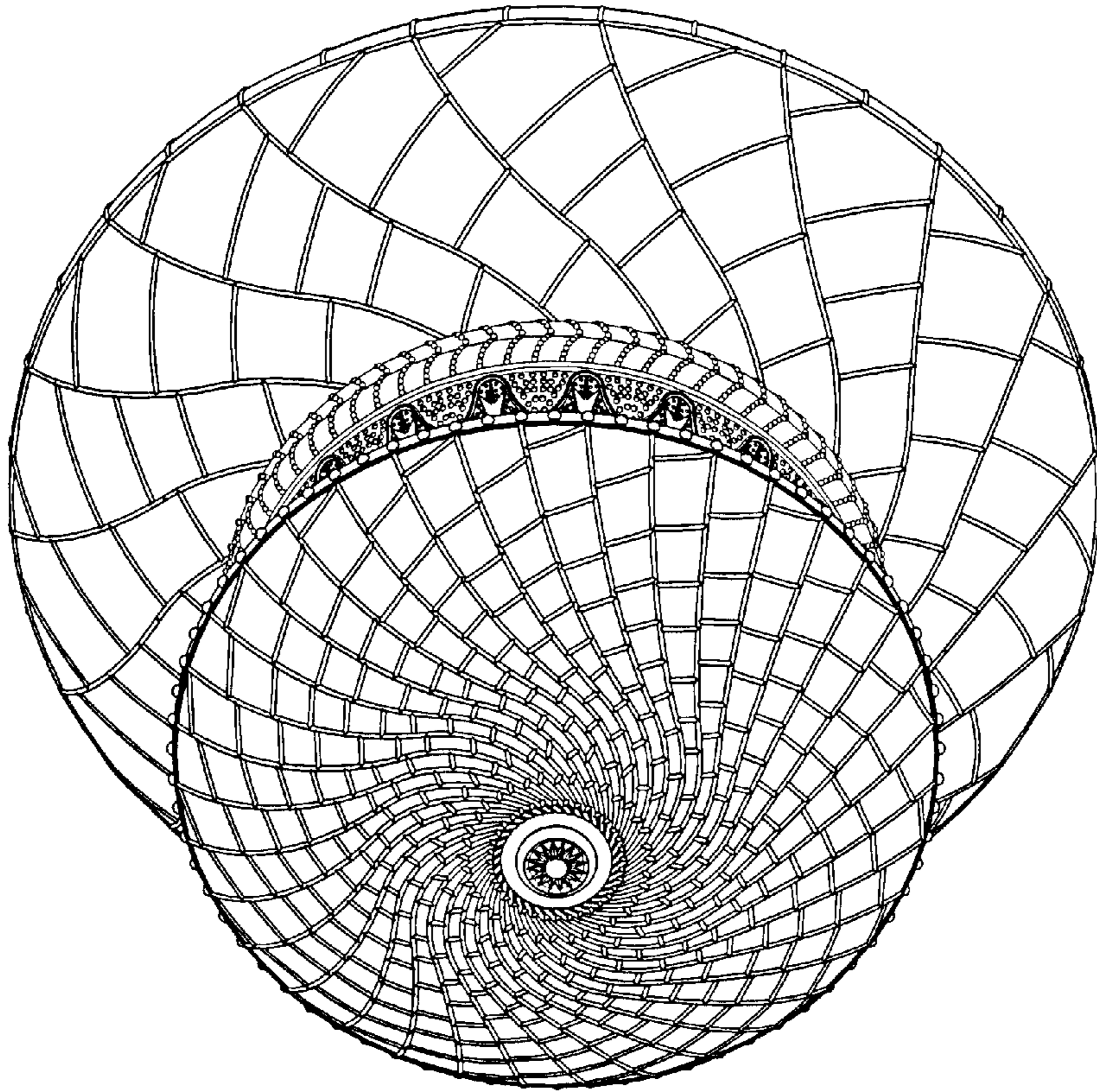

FIG. 1

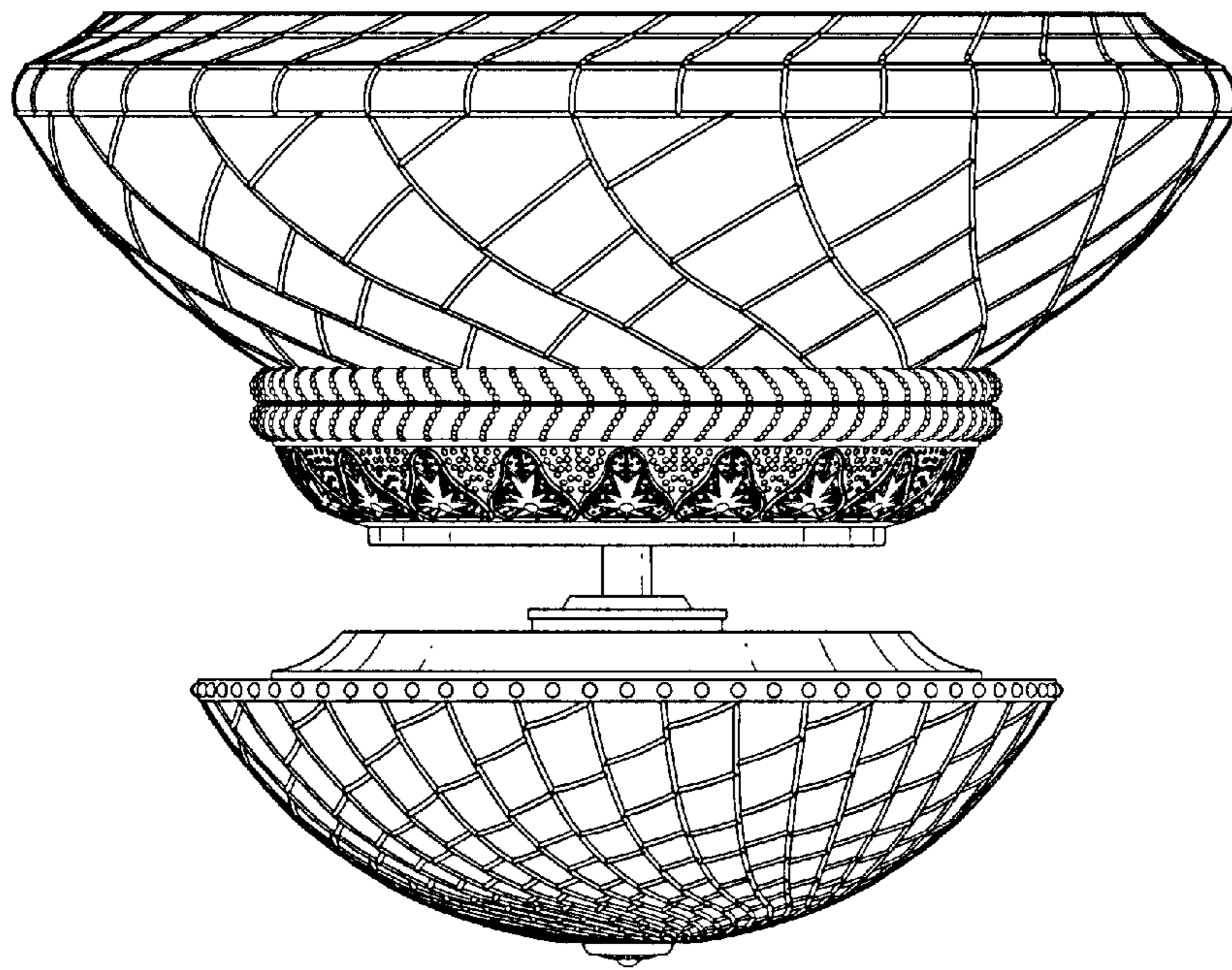

FIG. 2

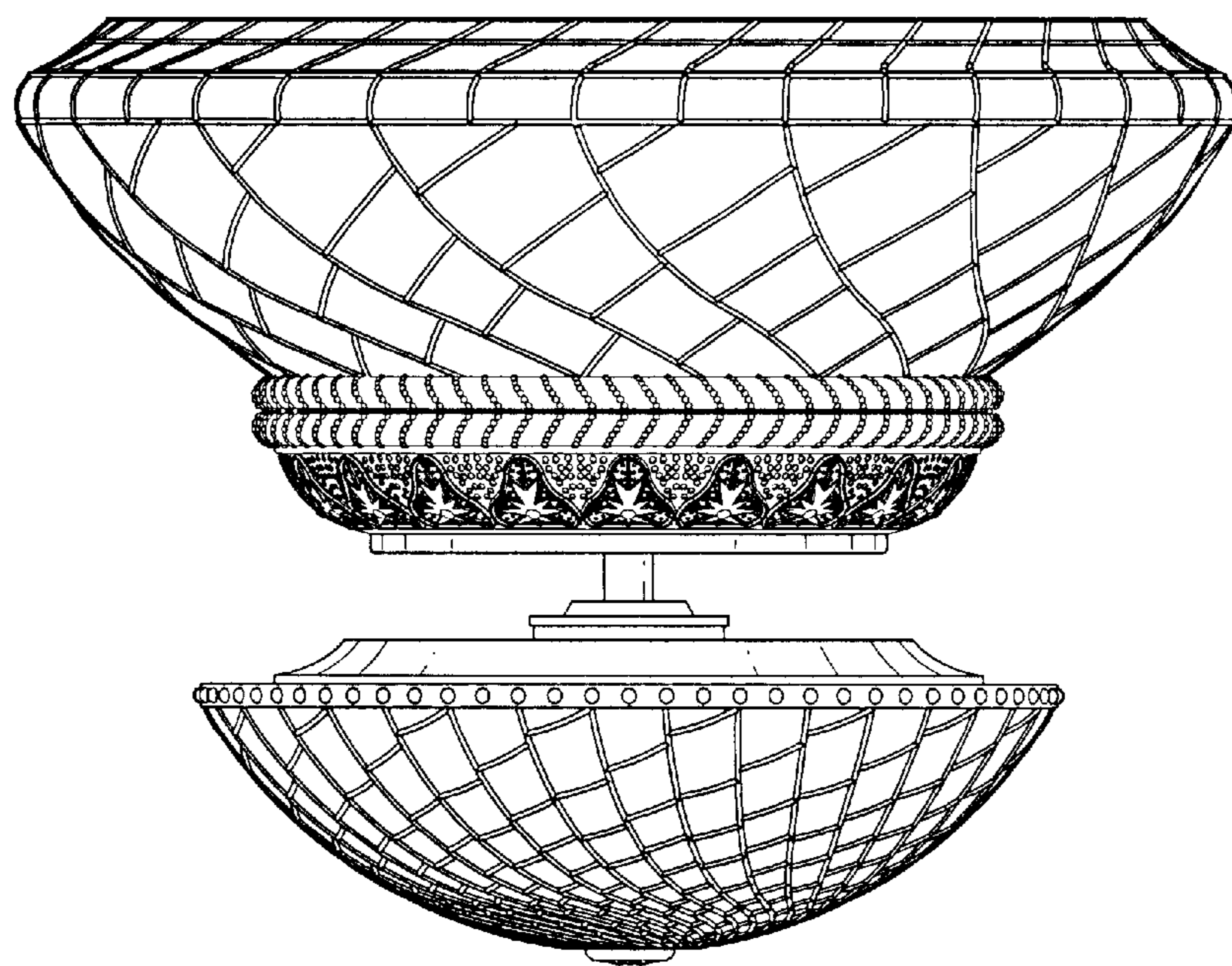

FIG. 3

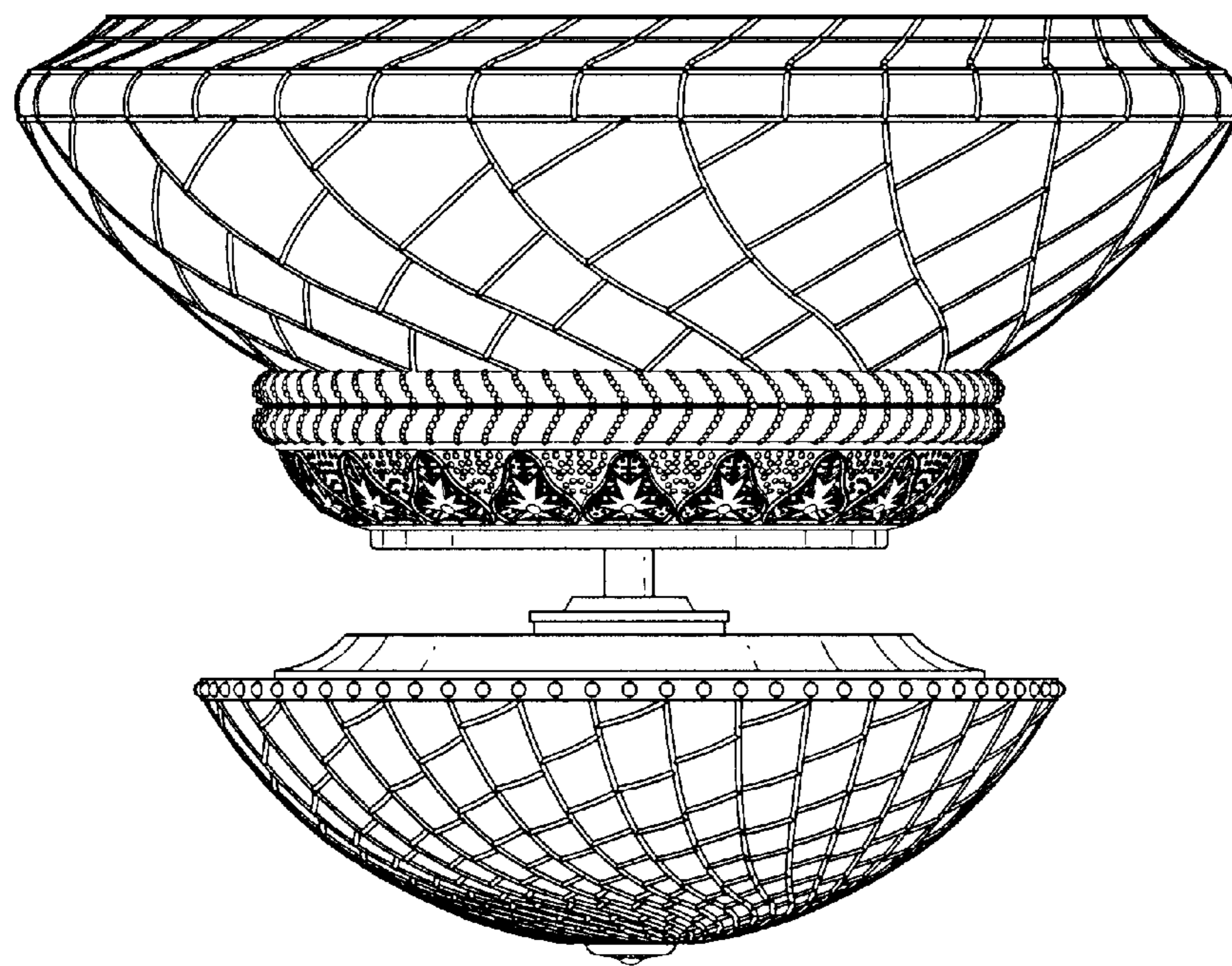

FIG. 4

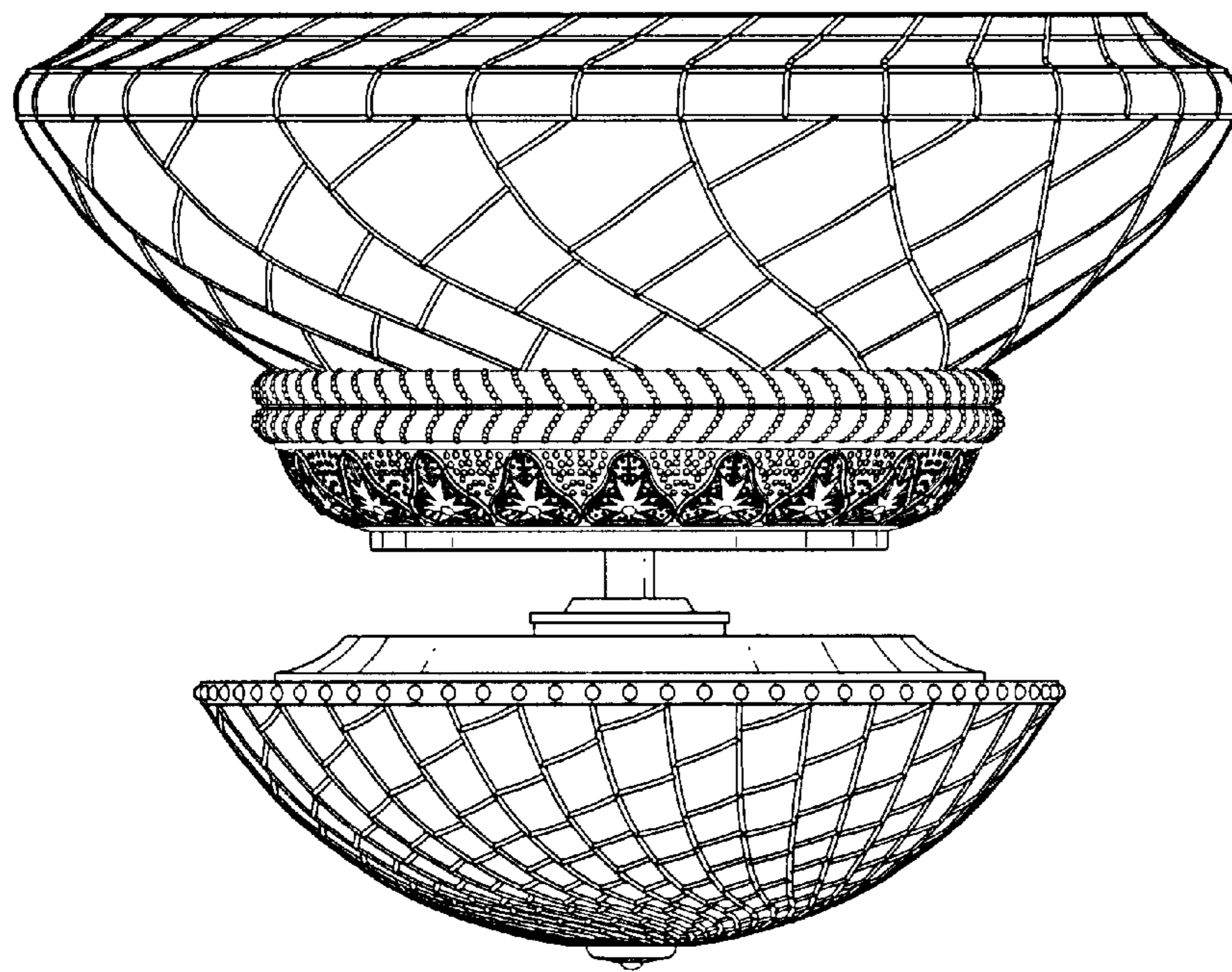

FIG. 5

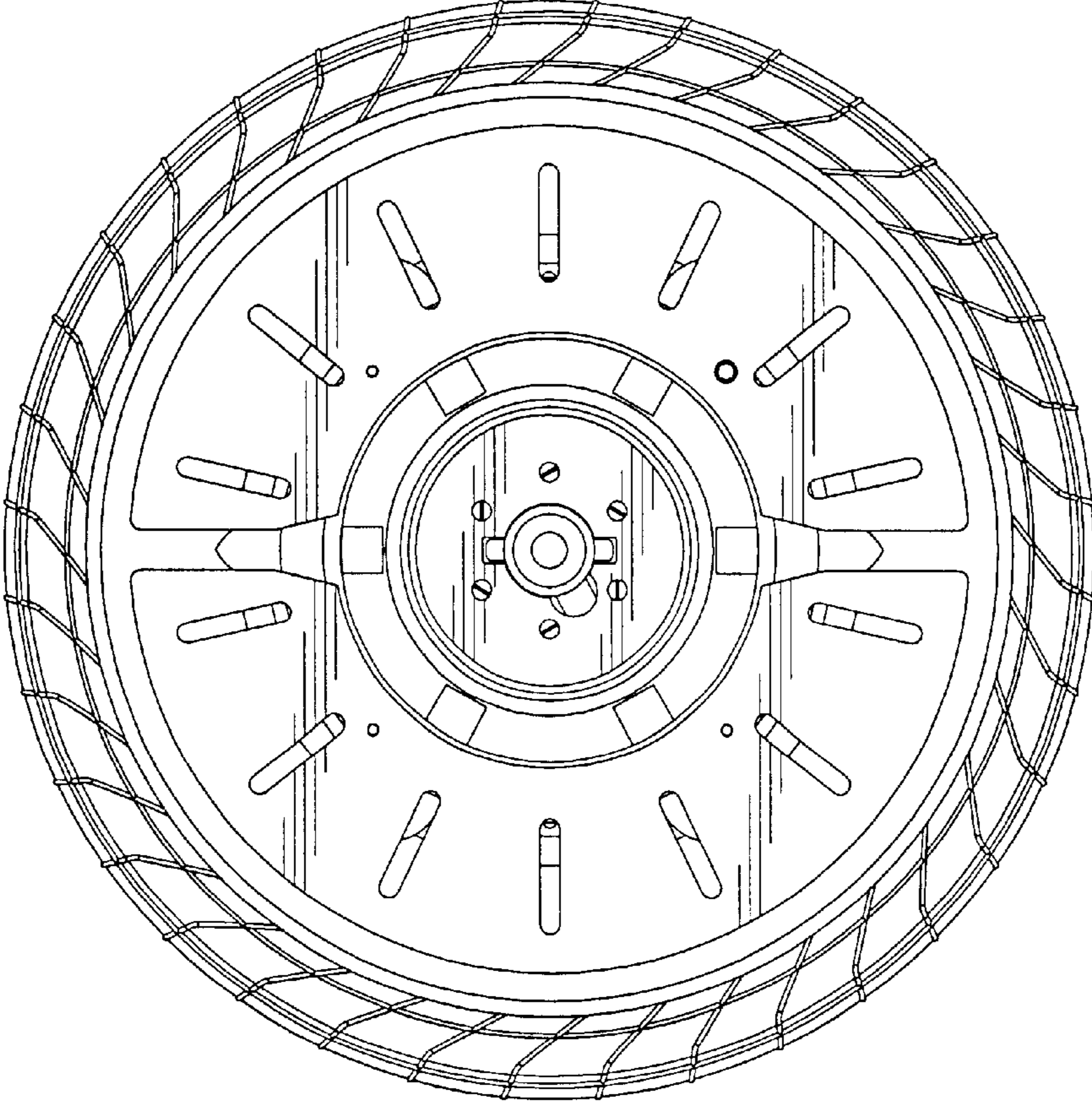

FIG. 6

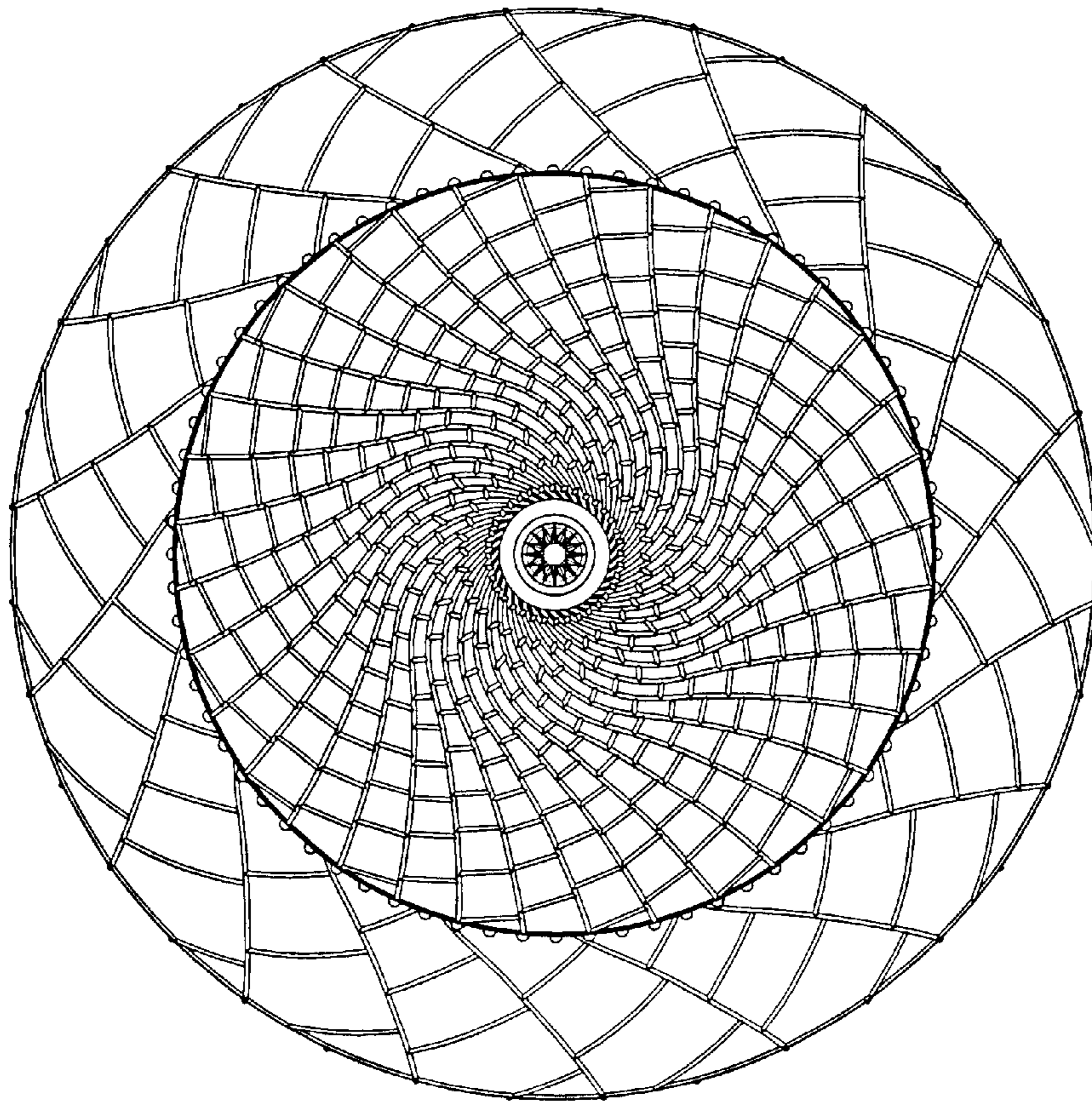

FIG. 7