

US00D543579S

(12) **United States Design Patent**
Taninbaum et al.

(10) **Patent No.:** **US D543,579 S**

(45) **Date of Patent:** **** May 29, 2007**

(54) **TAMBOURINE**

(75) Inventors: **Richard L. Taninbaum**, Mamaroneck, NY (US); **John R. Laverack**, Southbury, CT (US); **Greg Weaver**, Waterbury, CT (US)

(73) Assignee: **Rhythm Tech, Inc.**, New Rochelle, NY (US)

(**) Term: **14 Years**

(21) Appl. No.: **29/253,791**

(22) Filed: **Feb. 13, 2006**

(51) **LOC (8) Cl.** **17-04**

(52) **U.S. Cl.** **D17/22**

(58) **Field of Classification Search** D17/22;
84/104, 111, 406, 411 P, 411 R, 419, 402-404,
84/413-416, 420, 422.4, DIG. 12, DIG. 24;
D21/406-408, 487

See application file for complete search history.

(56) **References Cited**

U.S. PATENT DOCUMENTS

D259,047 S	*	4/1981	Taninbaum	D17/22
4,346,637 A	*	8/1982	Janszen	84/418
D268,419 S	*	3/1983	Taninbaum	D17/22
D306,608 S	*	3/1990	Wang	D17/22
D336,488 S	*	6/1993	Grey	D17/22
5,284,079 A	*	2/1994	Wang	84/418

D431,044 S	*	9/2000	Santini	D17/22
6,127,614 A	*	10/2000	Lombardi	84/418
D446,238 S	*	8/2001	Grey	D17/22
2006/0016320 A1	*	1/2006	Petrella	84/418
2006/0075877 A1	*	4/2006	Covello et al.	84/418

* cited by examiner

Primary Examiner—Ian Simmons

Assistant Examiner—R. Johnson

(74) *Attorney, Agent, or Firm*—Myron Greenspan, Esq.;
Lackebach Siegel, LLP

(57) **CLAIM**

We claim the ornamental design for a tambourine, as shown and described.

DESCRIPTION

FIG. 1 is a top plan view of a tambourine showing our new design;

FIG. 2 is a bottom plan view thereof;

FIG. 3 is a rear elevational view thereof;

FIG. 4 is a front elevational view thereof;

FIG. 5 is right-side elevational view thereof;

FIG. 6 is a left-side elevational view thereof;

FIG. 7 is a front perspective view thereof; and,

FIG. 8 is a rear perspective view thereof.

The broken lines shown throughout the views are for the purpose of illustrating environmental structure and form no part of the claimed design.

1 Claim, 3 Drawing Sheets

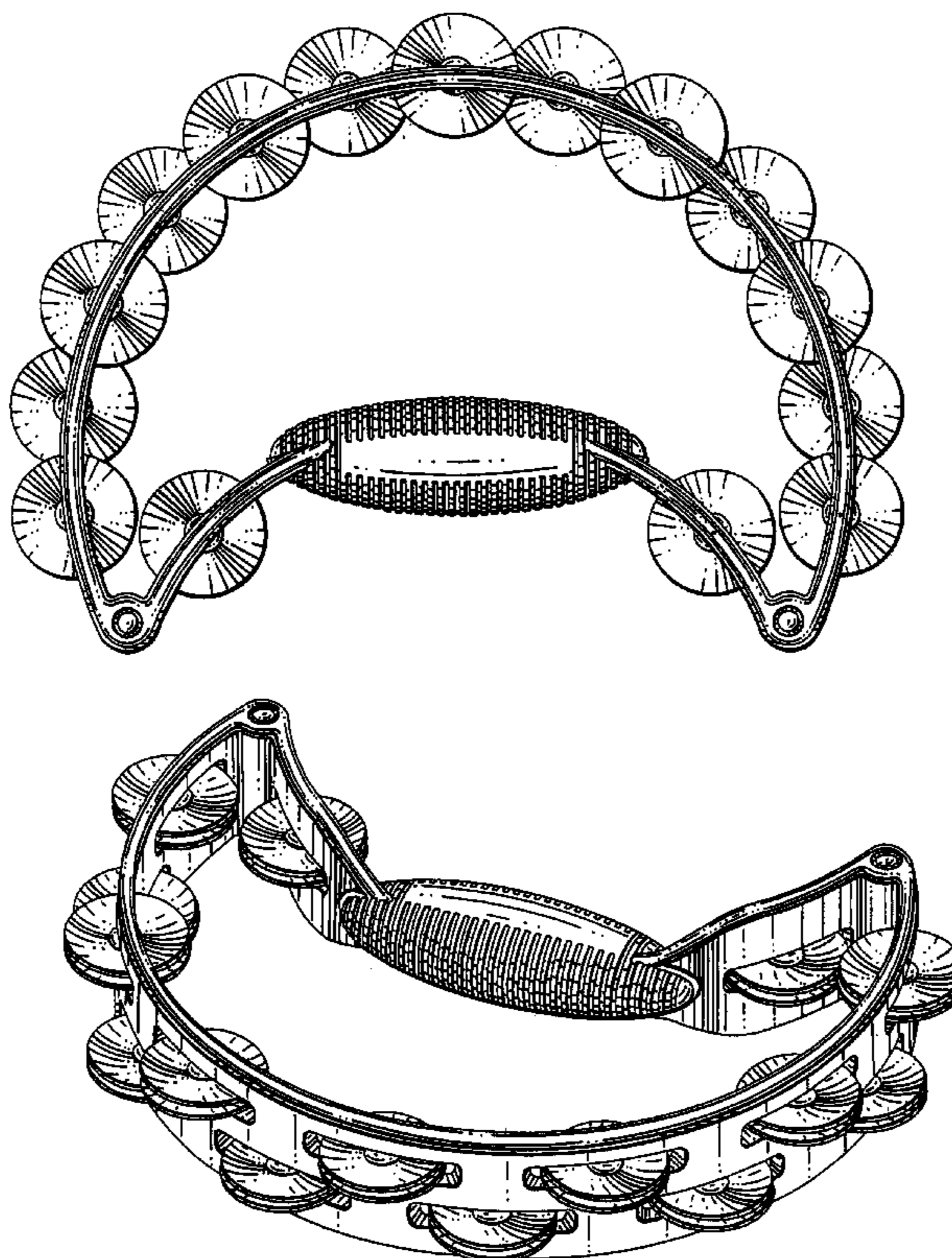

FIG. 1

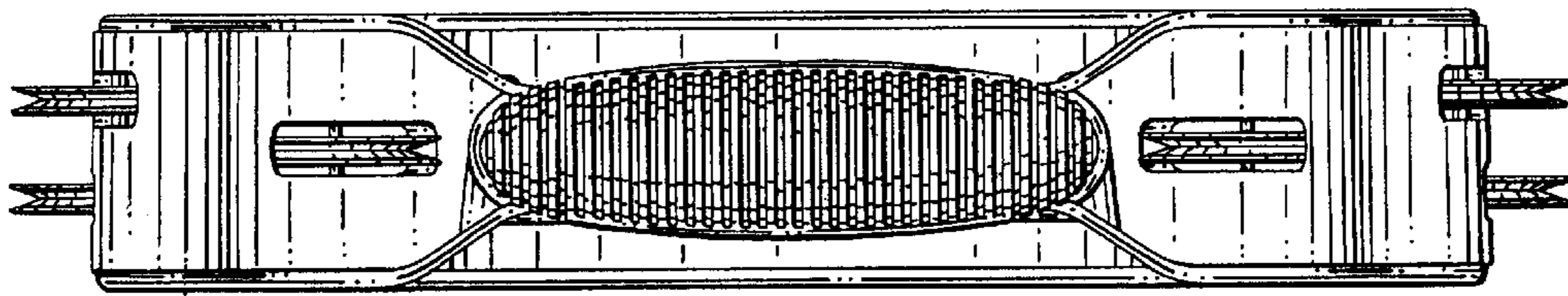
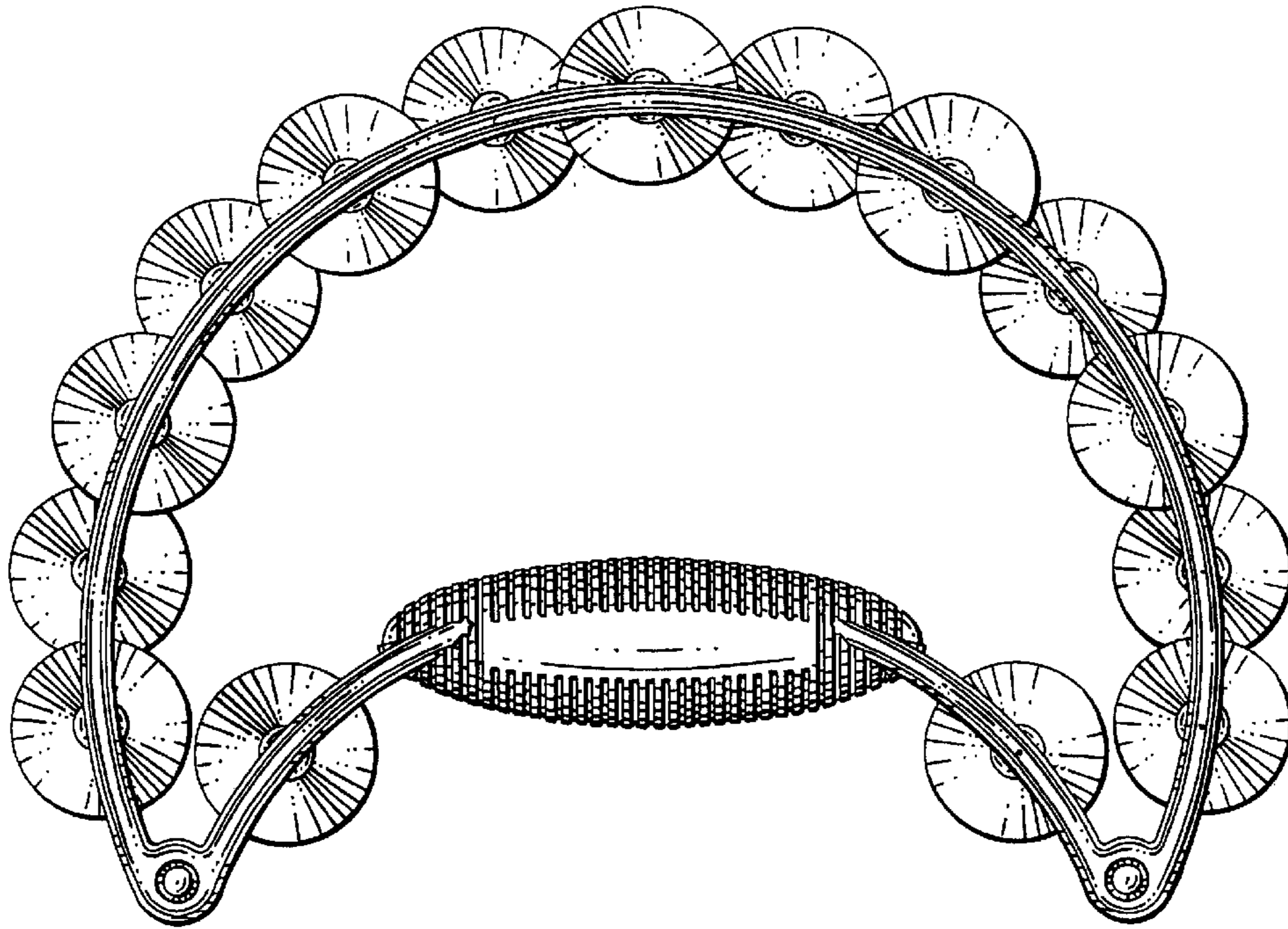

FIG. 3

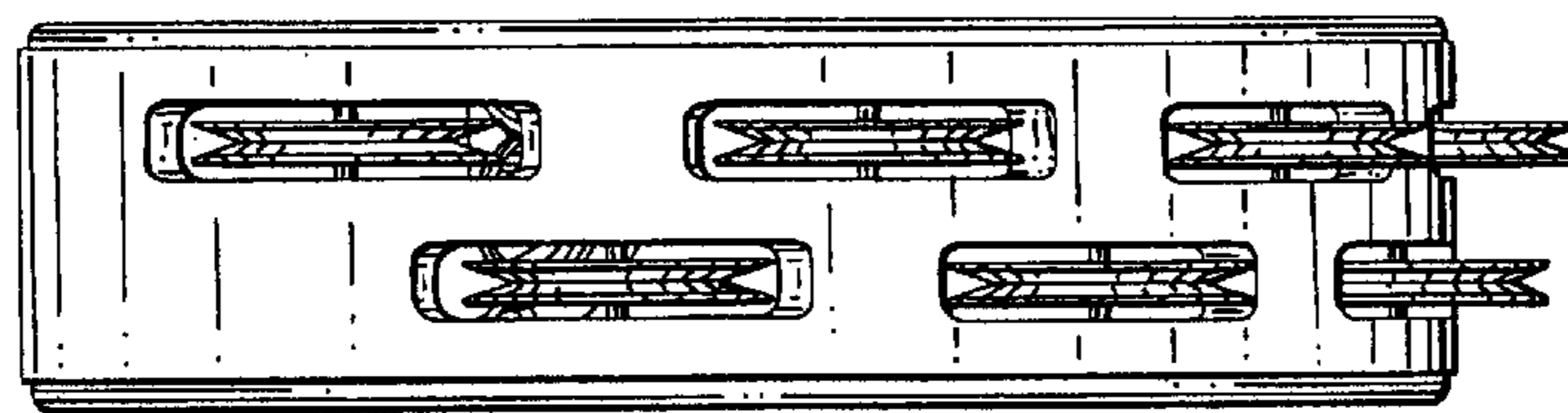

FIG. 5

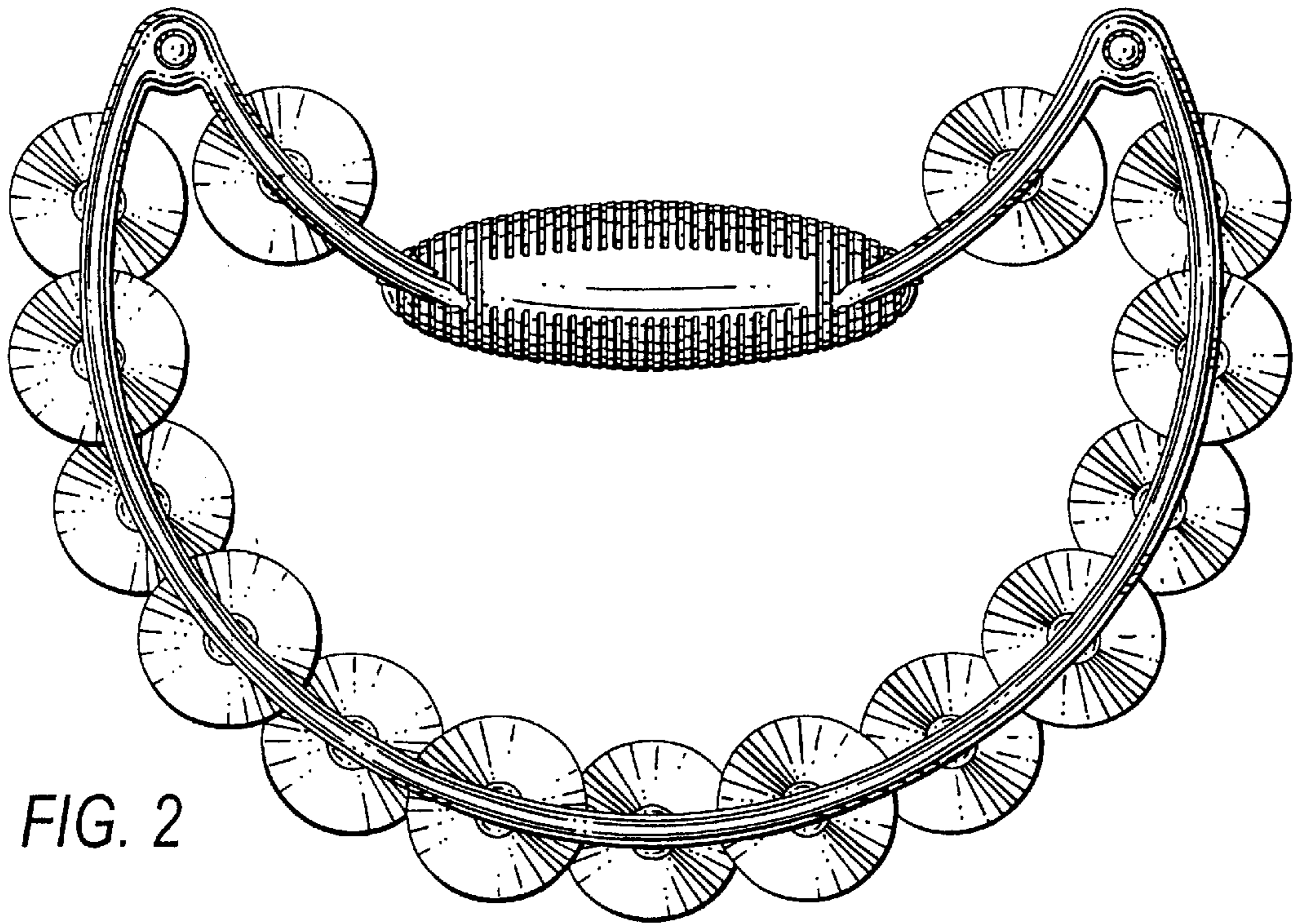

FIG. 2

FIG. 4

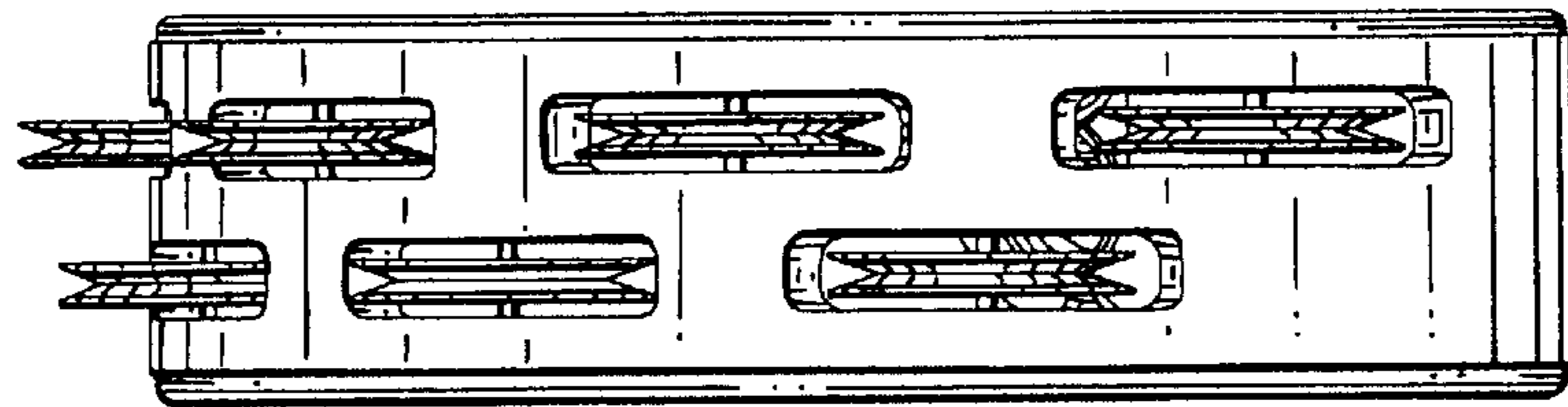
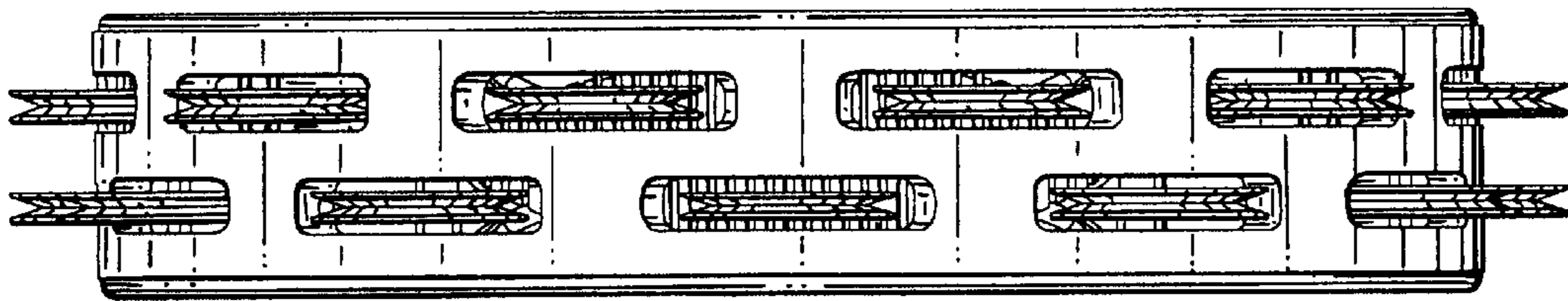

FIG. 6

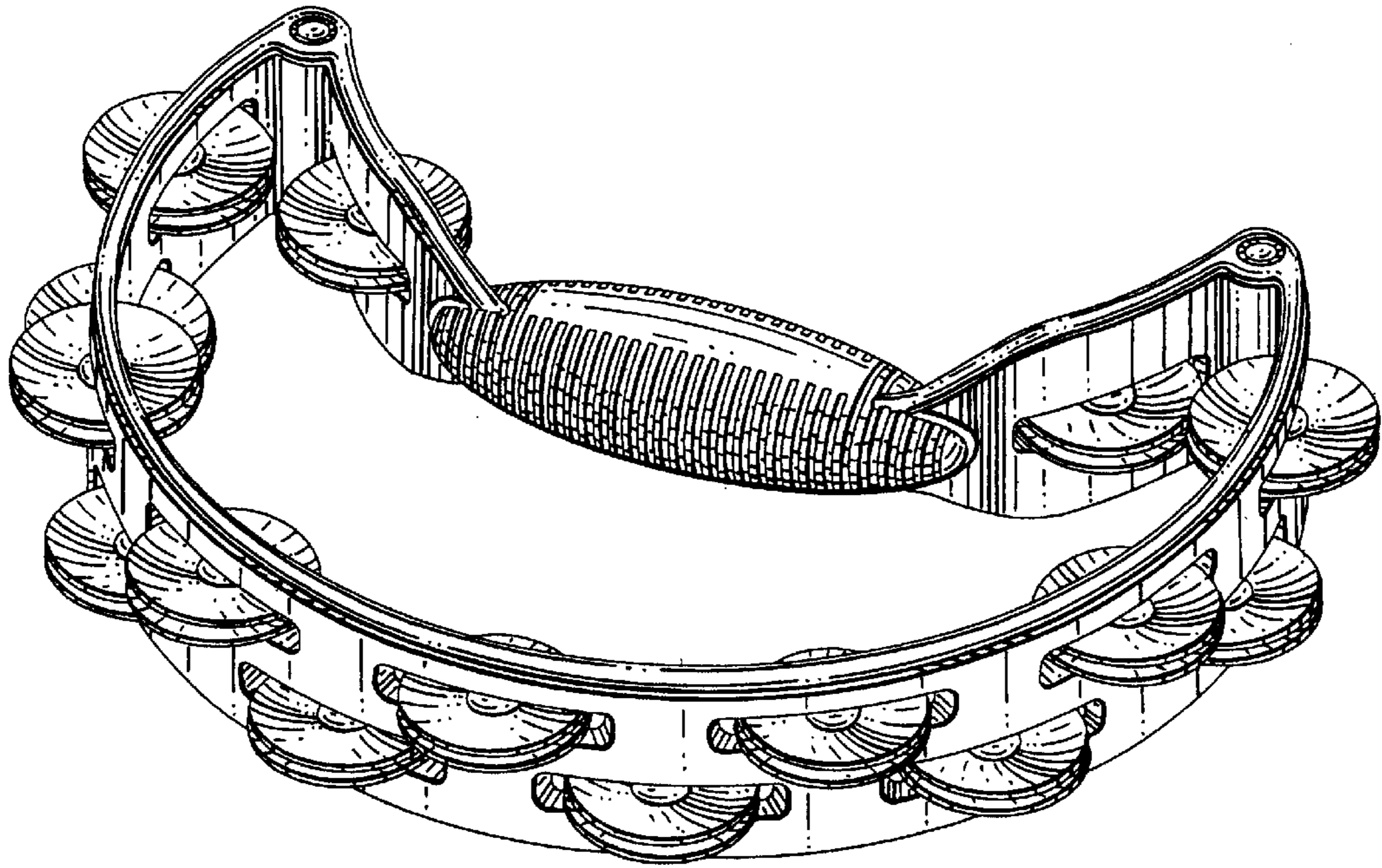

FIG. 7

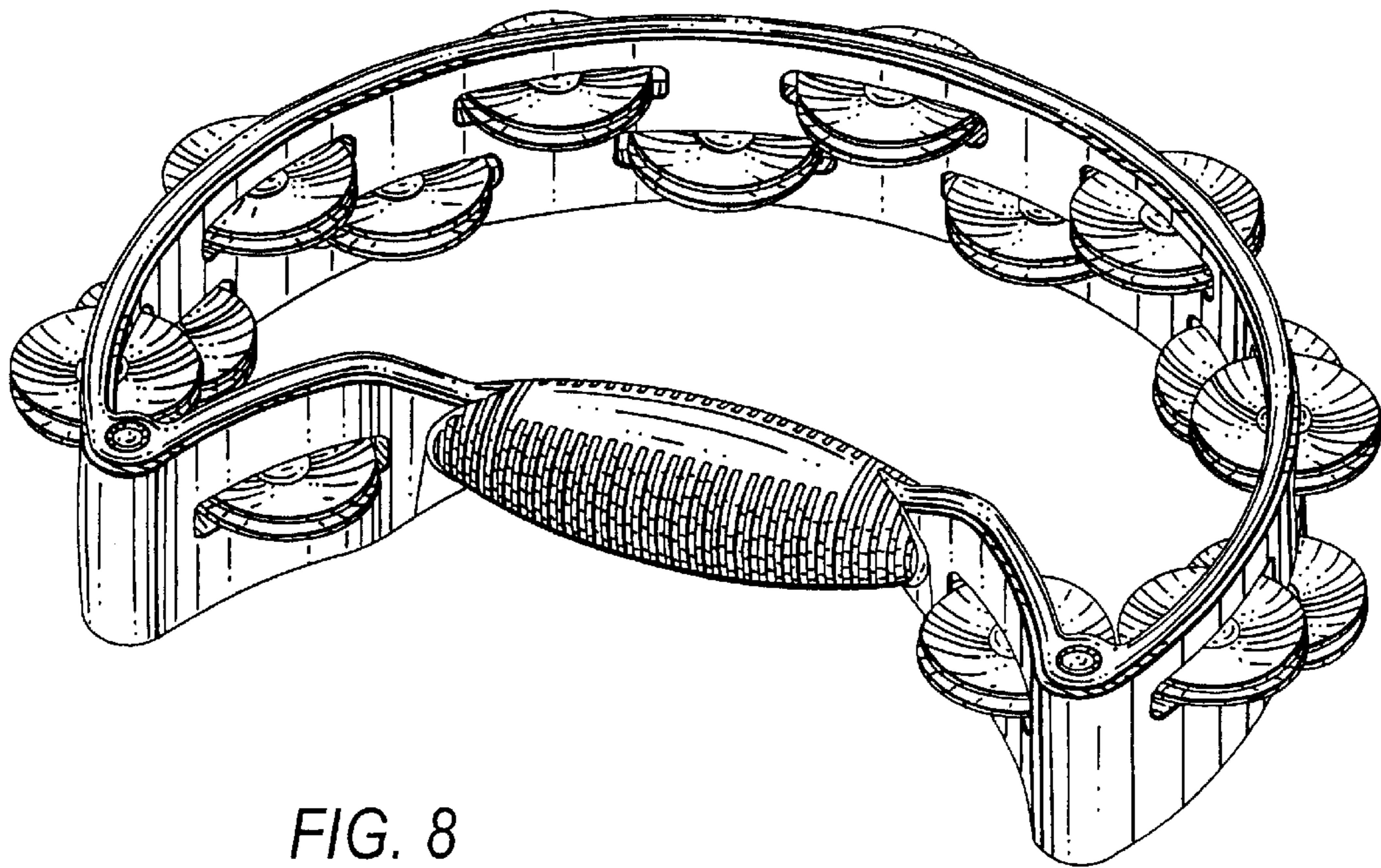

FIG. 8