

US00D543546S

(12) **United States Design Patent**
Zhou

(10) **Patent No.:** **US D543,546 S**

(45) **Date of Patent:** **** May 29, 2007**

(54) **FRONT BEZEL FOR COMPUTER ENCLOSURE**

(75) Inventor: **Peng Zhou**, Shenzhen (CN)

(73) Assignee: **Hon Hai Precision Industry Co., Ltd.**,
Tu-Cheng, Taipei Hsien (TW)

(**) Term: **14 Years**

(21) Appl. No.: **29/255,641**

(22) Filed: **Mar. 10, 2006**

(30) **Foreign Application Priority Data**

Feb. 21, 2006 (CN) 2006 30053130

(51) **LOC (8) Cl.** **14-02**

(52) **U.S. Cl.** **D14/441**

(58) **Field of Classification Search** D14/441-446;
D13/162, 184, 199; 312/223.2; 361/680-686,
361/690-696; 369/34.01, 36.01

See application file for complete search history.

(56) **References Cited**

U.S. PATENT DOCUMENTS

D425,044 S * 5/2000 Jean et al. D14/446

D438,517 S * 3/2001 Chen et al. D14/444

D459,357 S * 6/2002 Lo D14/444

D500,043 S * 12/2004 Zhang et al. D14/441

D512,070 S * 11/2005 He et al. D14/444

D514,110 S * 1/2006 Liu et al. D14/441

* cited by examiner

Primary Examiner—Freda S. Nunn

(74) *Attorney, Agent, or Firm*—Wei-Te Chung

(57) **CLAIM**

The ornamental design for a front bezel for a computer enclosure, as shown and described.

DESCRIPTION

FIG. 1 is a perspective view of a front bezel for a computer enclosure showing my new design;

FIG. 2 is a front elevational view thereof;

FIG. 3 is a rear elevational view thereof;

FIG. 4 is a left side elevational view thereof;

FIG. 5 is a right side elevational view thereof;

FIG. 6 is a top plan view thereof;

FIG. 7 is a bottom plan view thereof; and,

FIG. 8 is a perspective view thereof being mounted to a computer enclosure.

Broken lines are for illustrative purposes only and form no part of the claimed design.

1 Claim, 6 Drawing Sheets

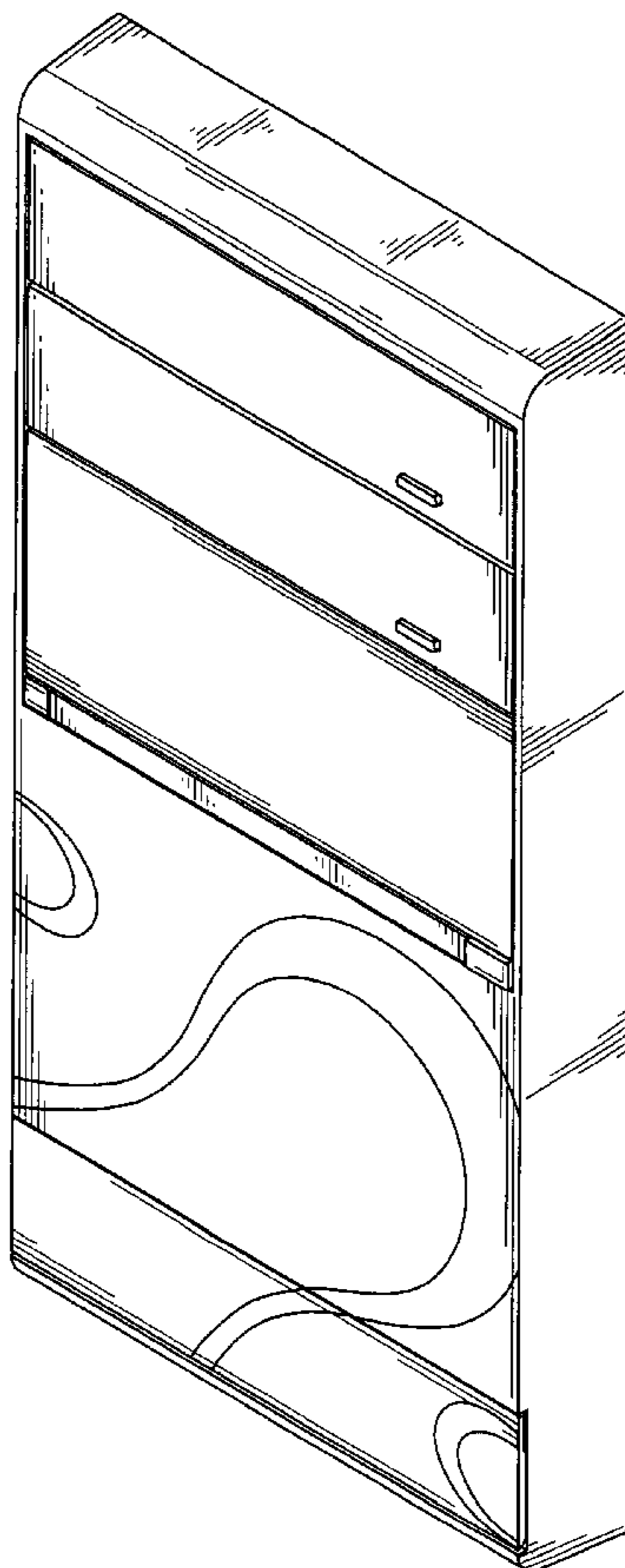

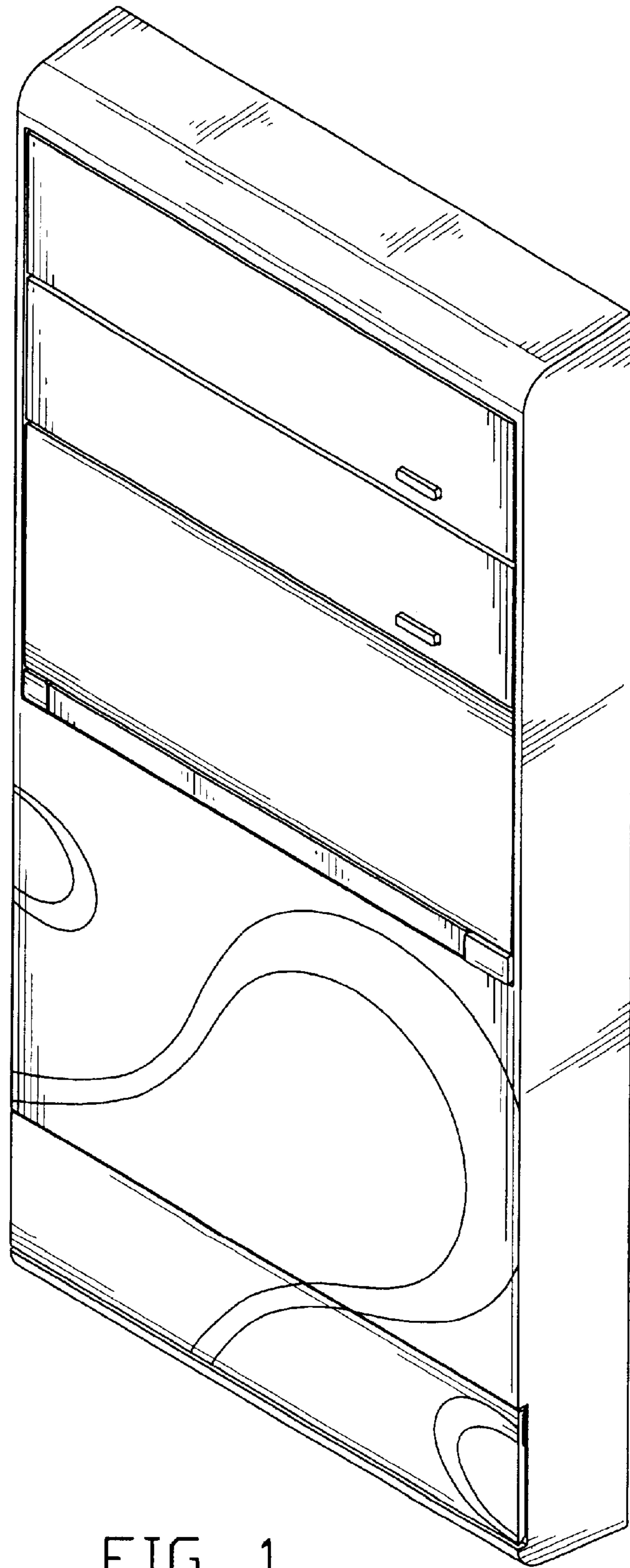

FIG. 1

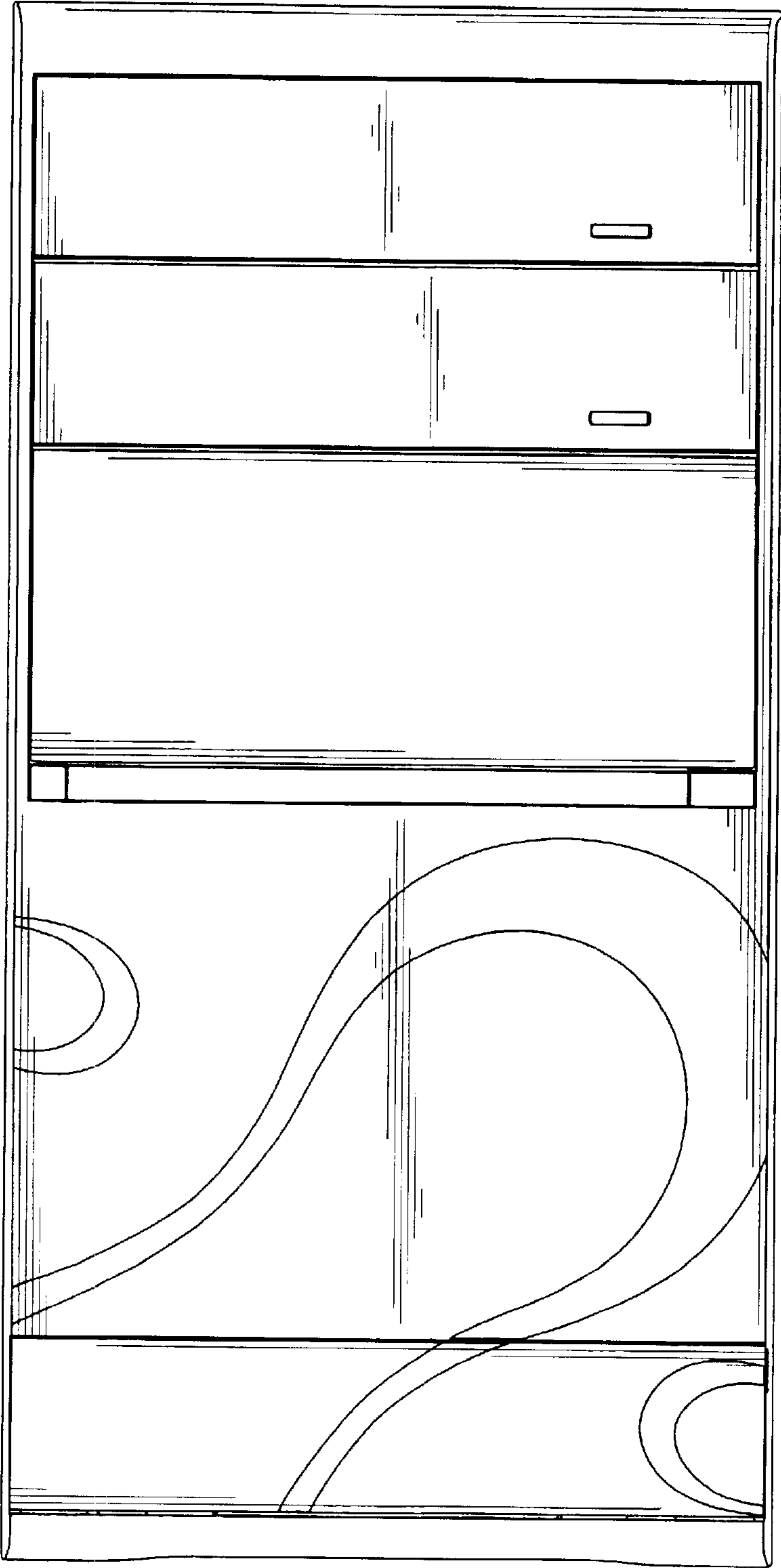

FIG. 2

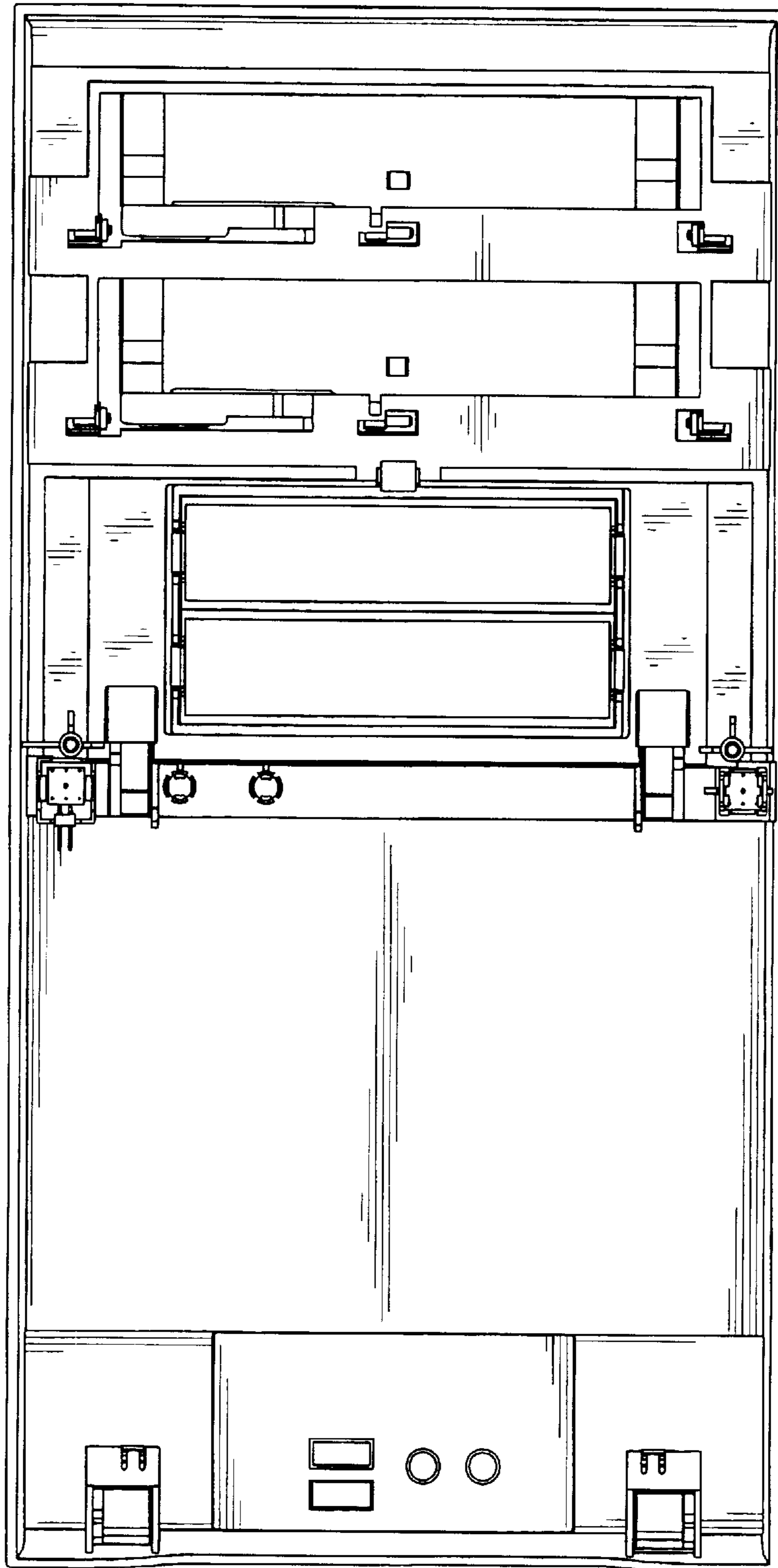

FIG. 3

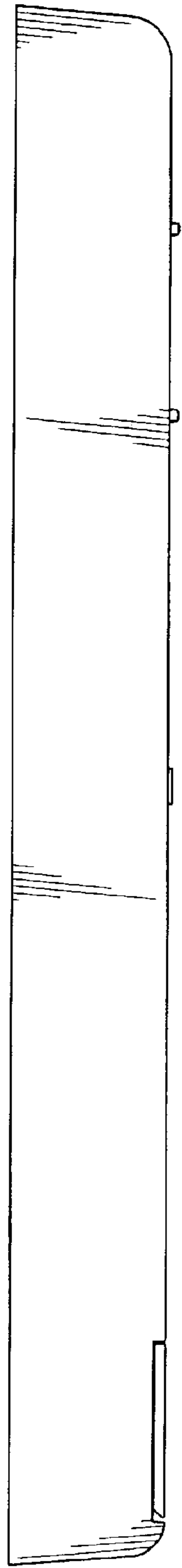

FIG. 4

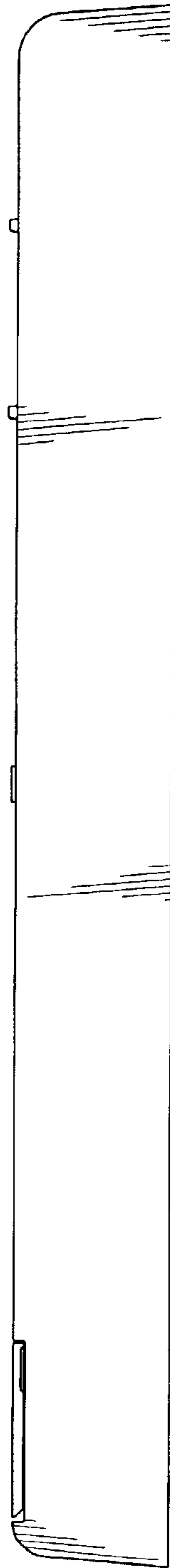

FIG. 5

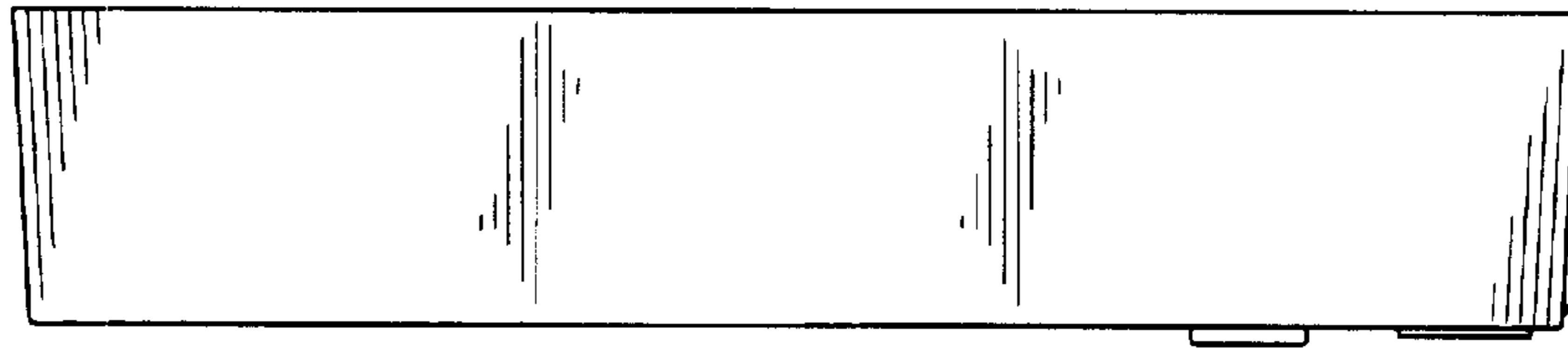

FIG. 6

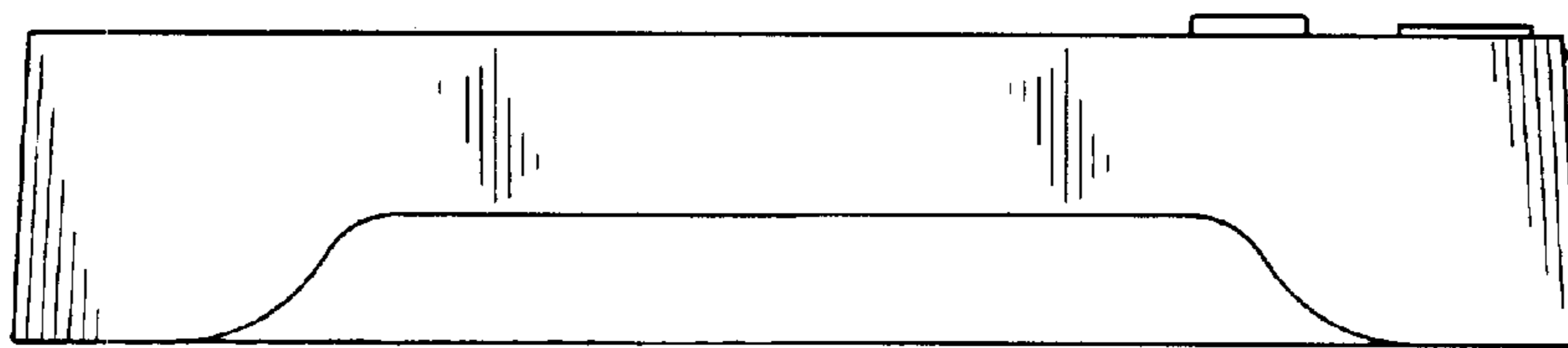

FIG. 7

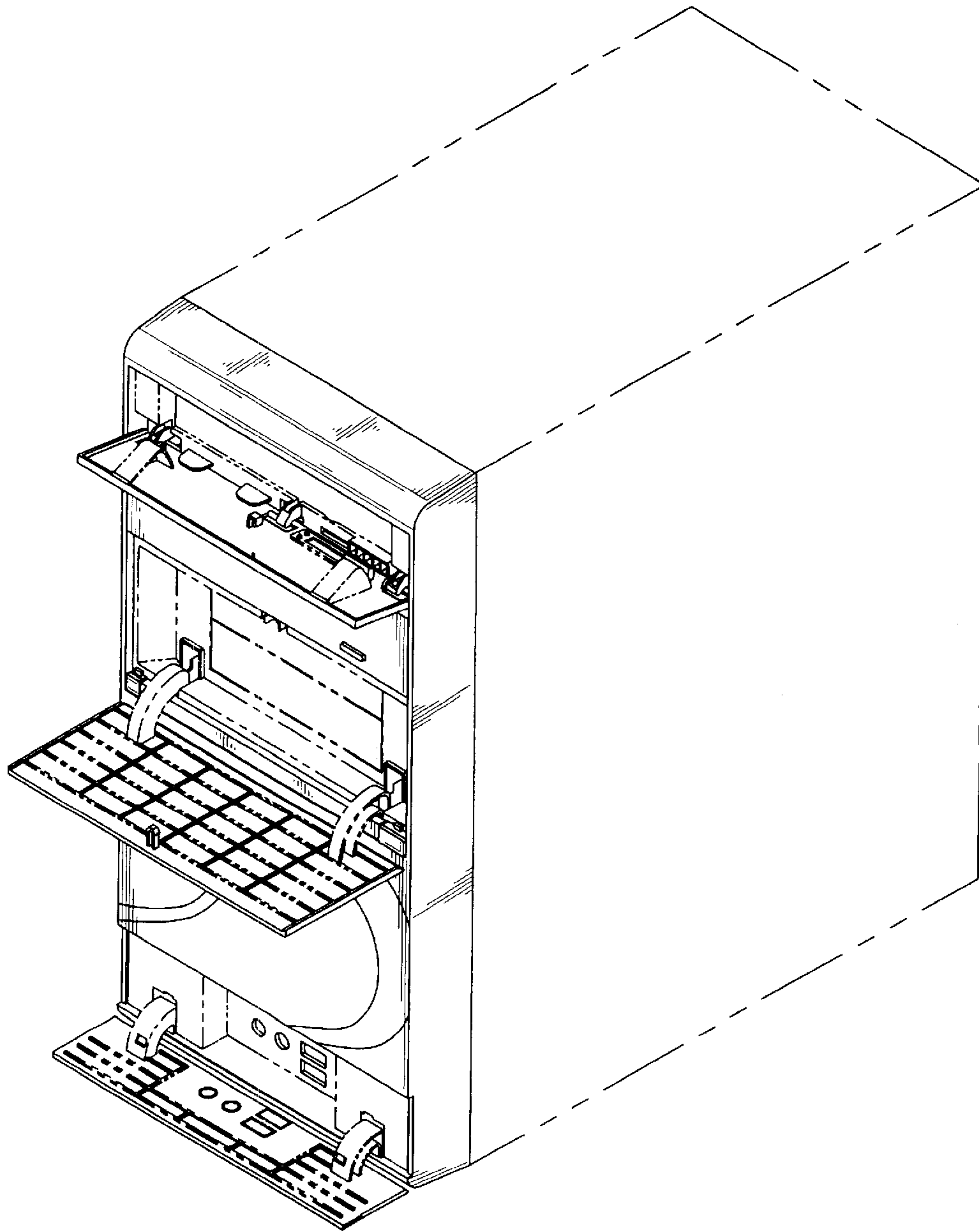

FIG. 8