

US00D543321S

(12) **United States Design Patent**
Jeon et al.

(10) **Patent No.:** **US D543,321 S**

(45) **Date of Patent:** **** May 22, 2007**

(54) **DISH WASHER**

(75) Inventors: **Jong Soo Jeon**, Gyeonggi-do (KR);
Kyung Ho Chai, Gyeonggi-Do (KR)

(73) Assignee: **Samsung Electronics Co., Ltd.**, Suwon (KR)

(**) Term: **14 Years**

(21) Appl. No.: **29/263,950**

(22) Filed: **Aug. 1, 2006**

(51) **LOC (8) Cl.** **15-05**

(52) **U.S. Cl.** **D32/2**

(58) **Field of Classification Search** D32/2,
D32/3, 28; D7/348, 349, 405, 406; 134/108,
134/109, 113, 201; 312/31

See application file for complete search history.

(56) **References Cited**

U.S. PATENT DOCUMENTS

- D493,580 S * 7/2004 Ott et al. D32/3
- D493,583 S * 7/2004 Kaczmarek D32/3
- D511,403 S * 11/2005 Ott et al. D32/3
- D511,870 S * 11/2005 Paik D32/2
- D512,543 S * 12/2005 Jeong D32/2

- D512,544 S * 12/2005 Jeong et al. D32/3
- D513,548 S * 1/2006 Jeong D32/2
- D515,255 S * 2/2006 Jeong D32/3
- D521,195 S * 5/2006 Park et al. D32/2

* cited by examiner

Primary Examiner—Louis S. Zarfaz

Assistant Examiner—Kathleen Sims

(74) *Attorney, Agent, or Firm*—Ladas and Parry LLP

(57) **CLAIM**

We claim the ornamental design for a dish washer, as shown.

DESCRIPTION

FIG. 1 is a top, front, and left side perspective view of a dish washer showing our new design;
 FIG. 2 is a front elevational view thereof;
 FIG. 3 is a rear elevational view thereof;
 FIG. 4 is a left side elevational view thereof;
 FIG. 5 is a right side elevational view thereof;
 FIG. 6 is a top plan view thereof;
 FIG. 7 is a bottom plan view thereof; and,
 FIG. 8 is a top, front, and left side perspective view of the dish washer of FIG. 1 shown with a front door in an open position and exposing a control panel on a top edge of the door.

1 Claim, 8 Drawing Sheets

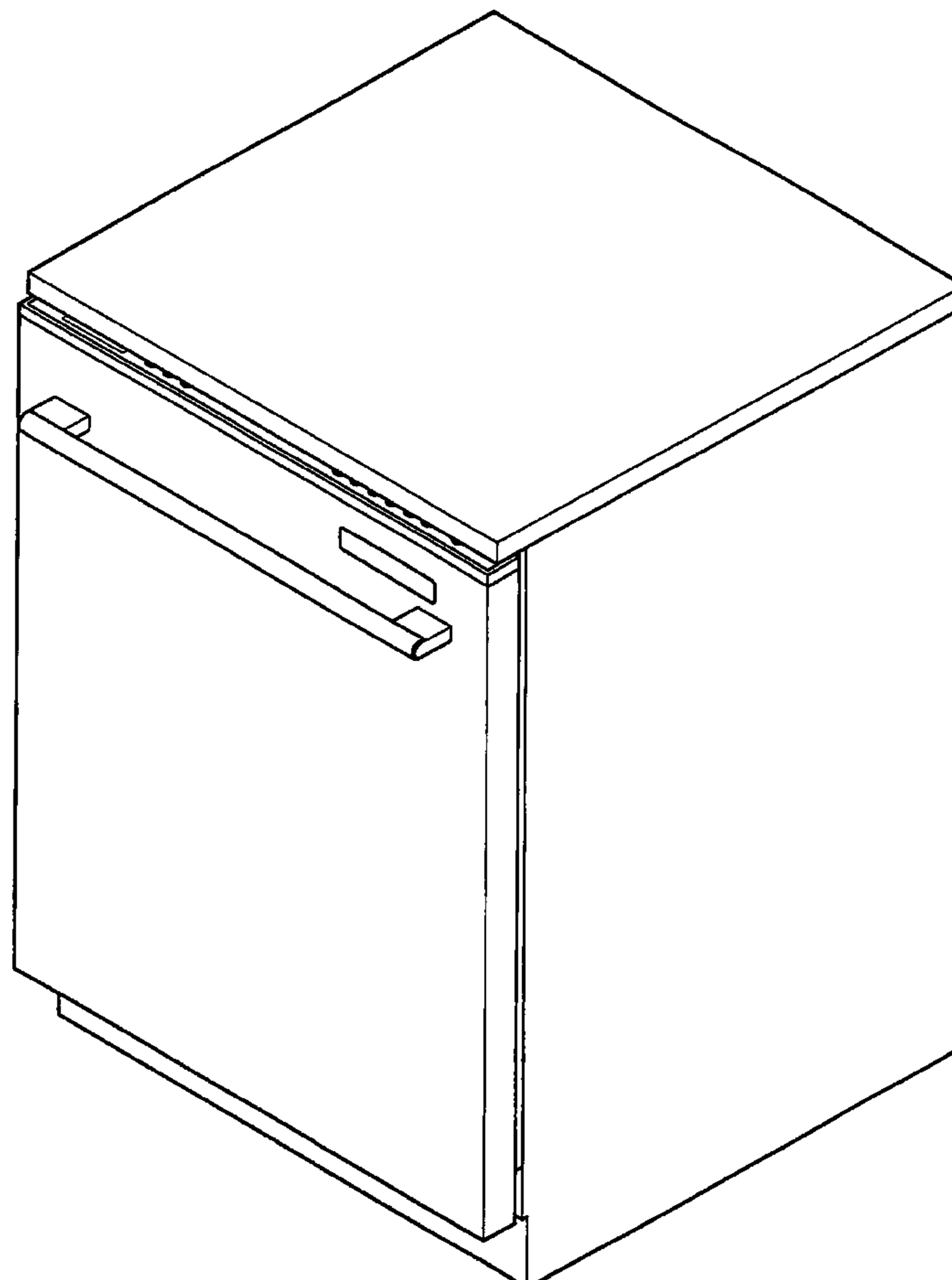

FIG. 1

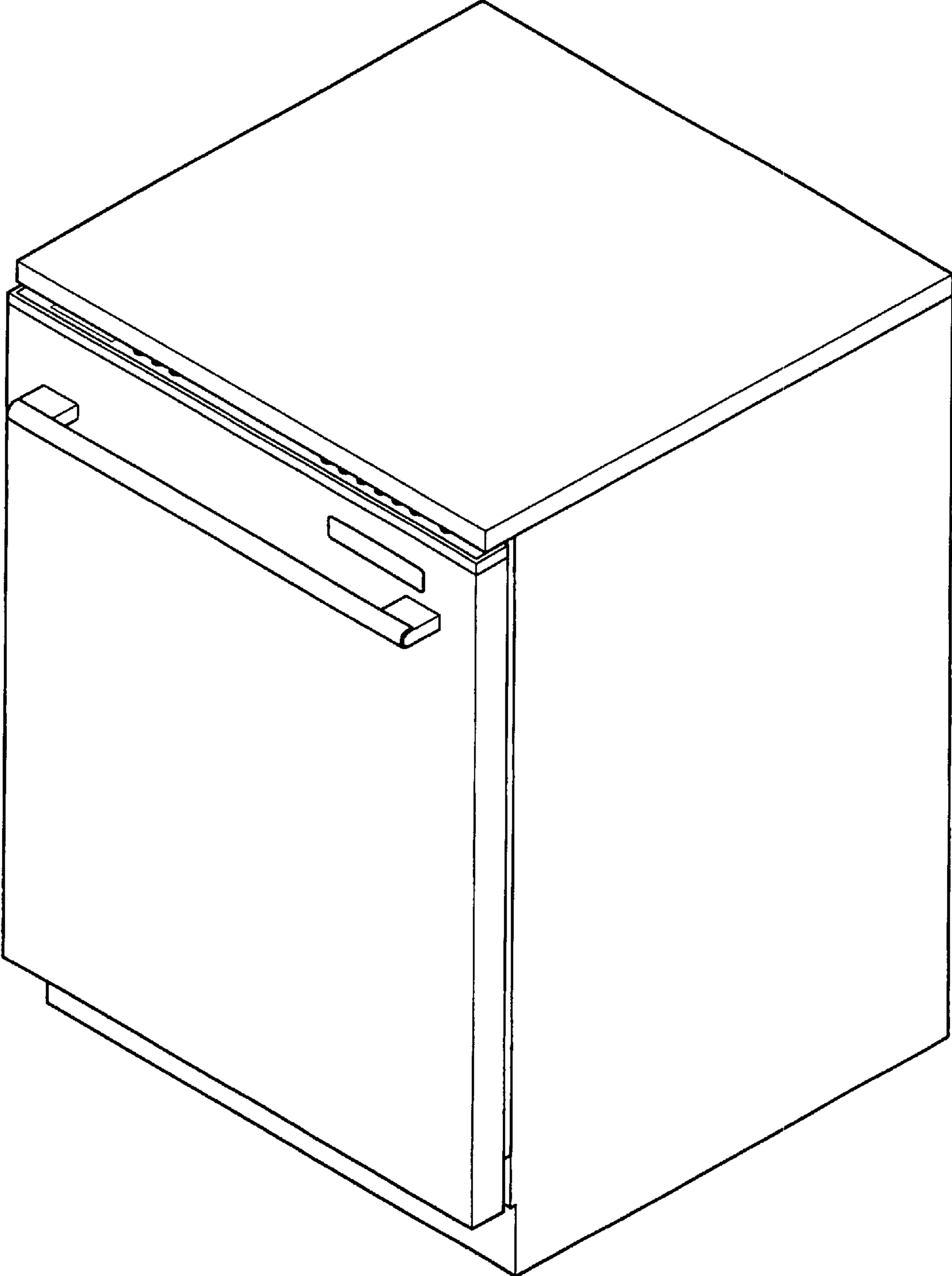

FIG. 2

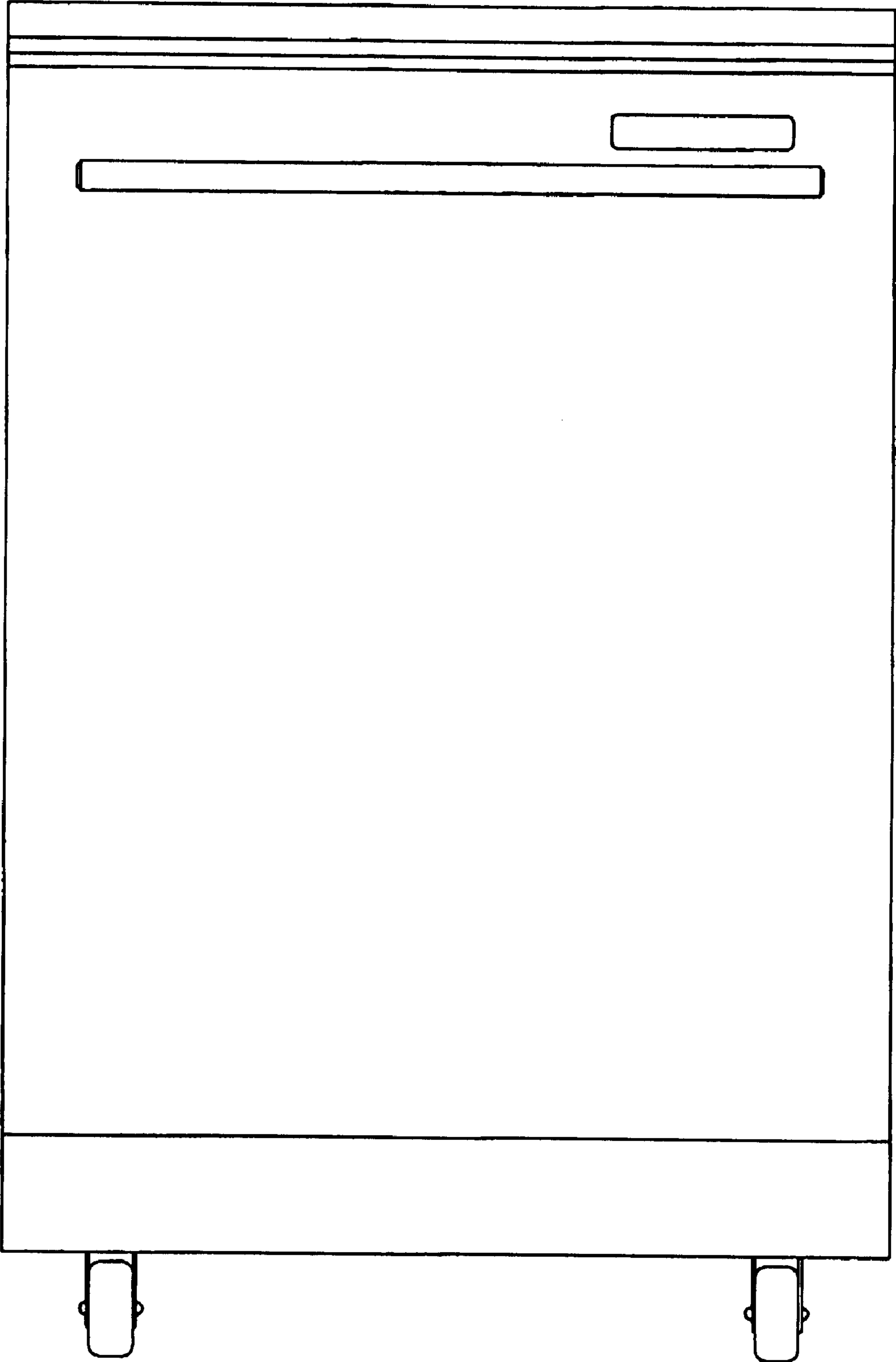

FIG. 3

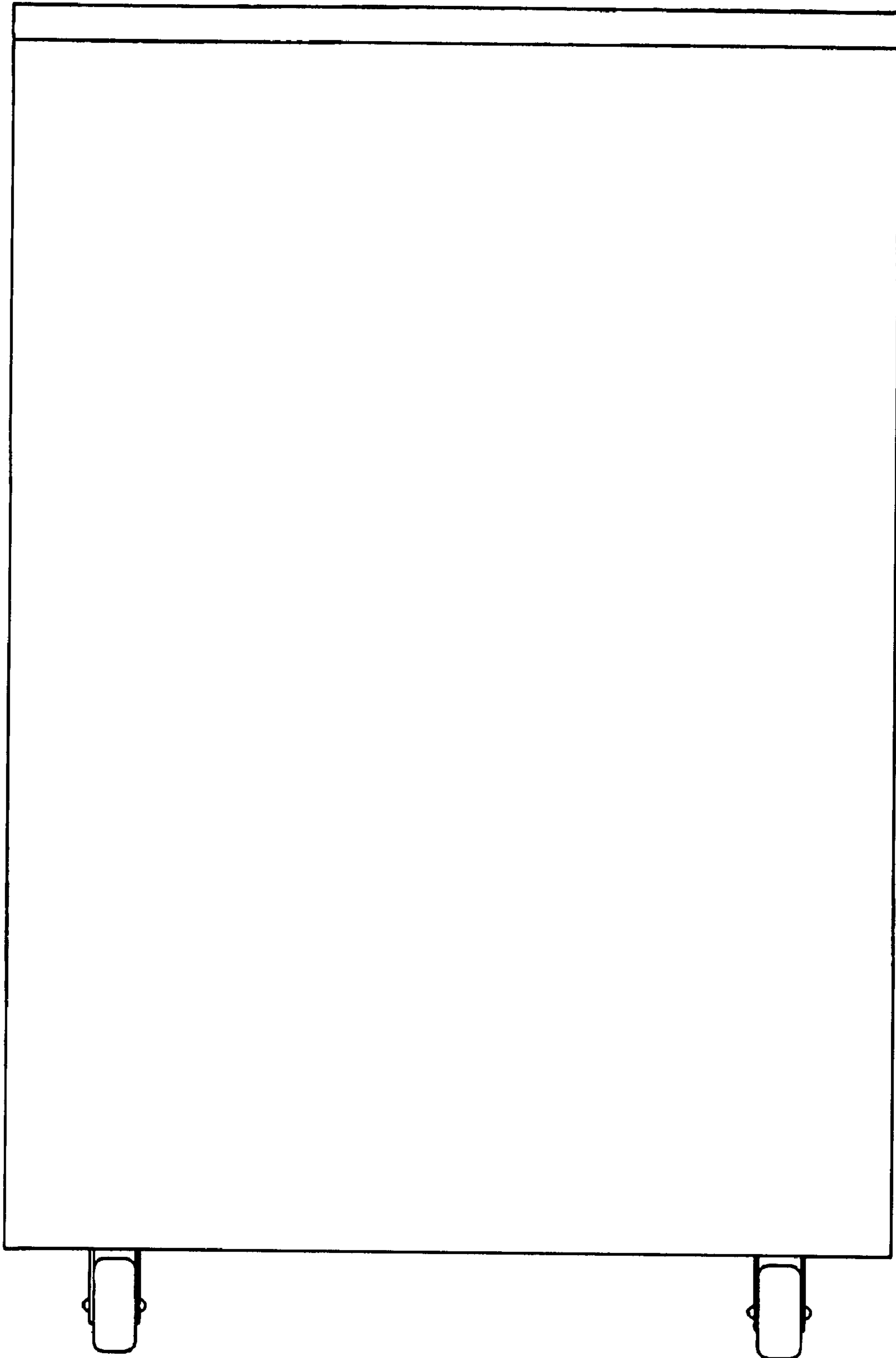

FIG. 4

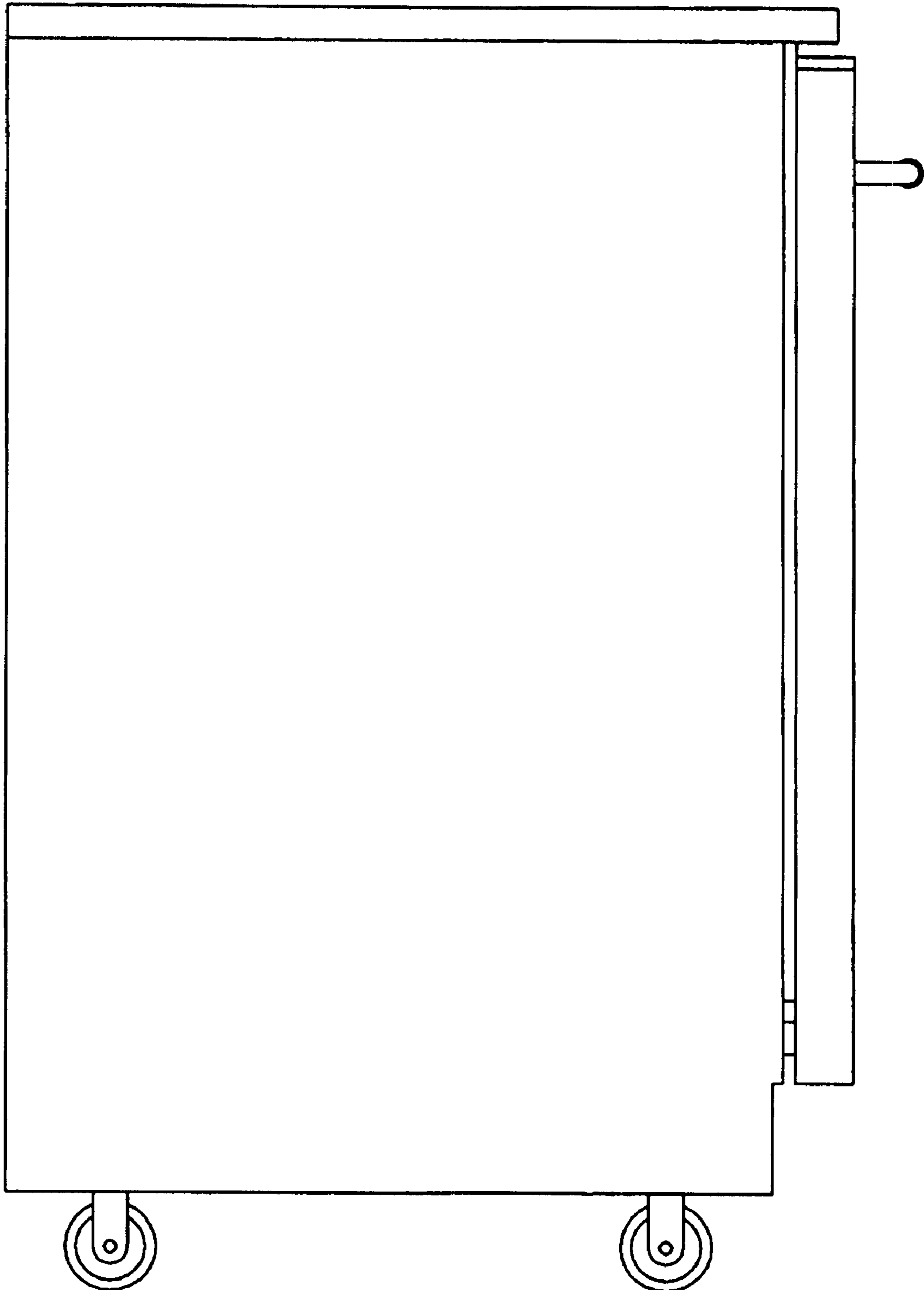

FIG. 5

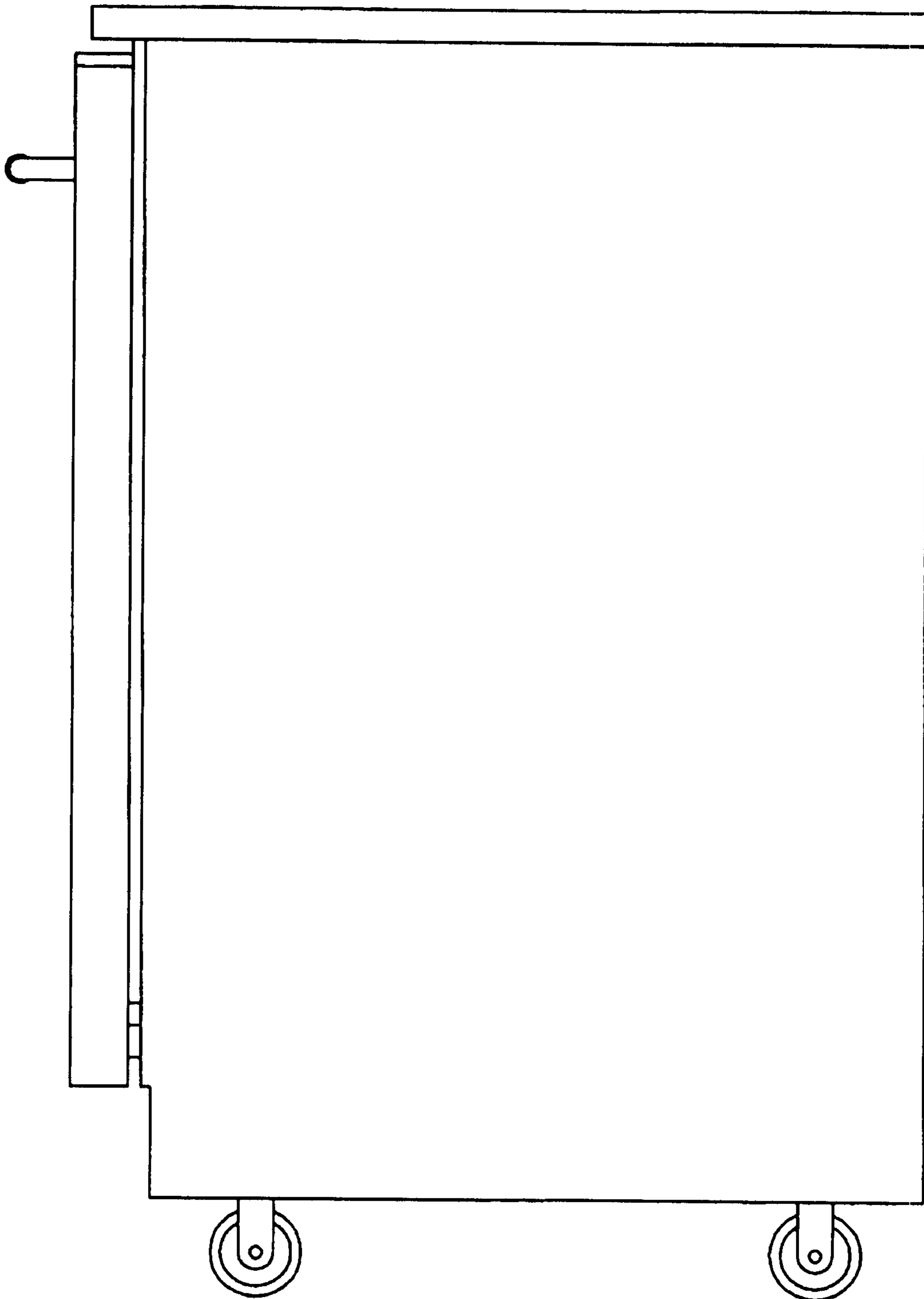

FIG. 6

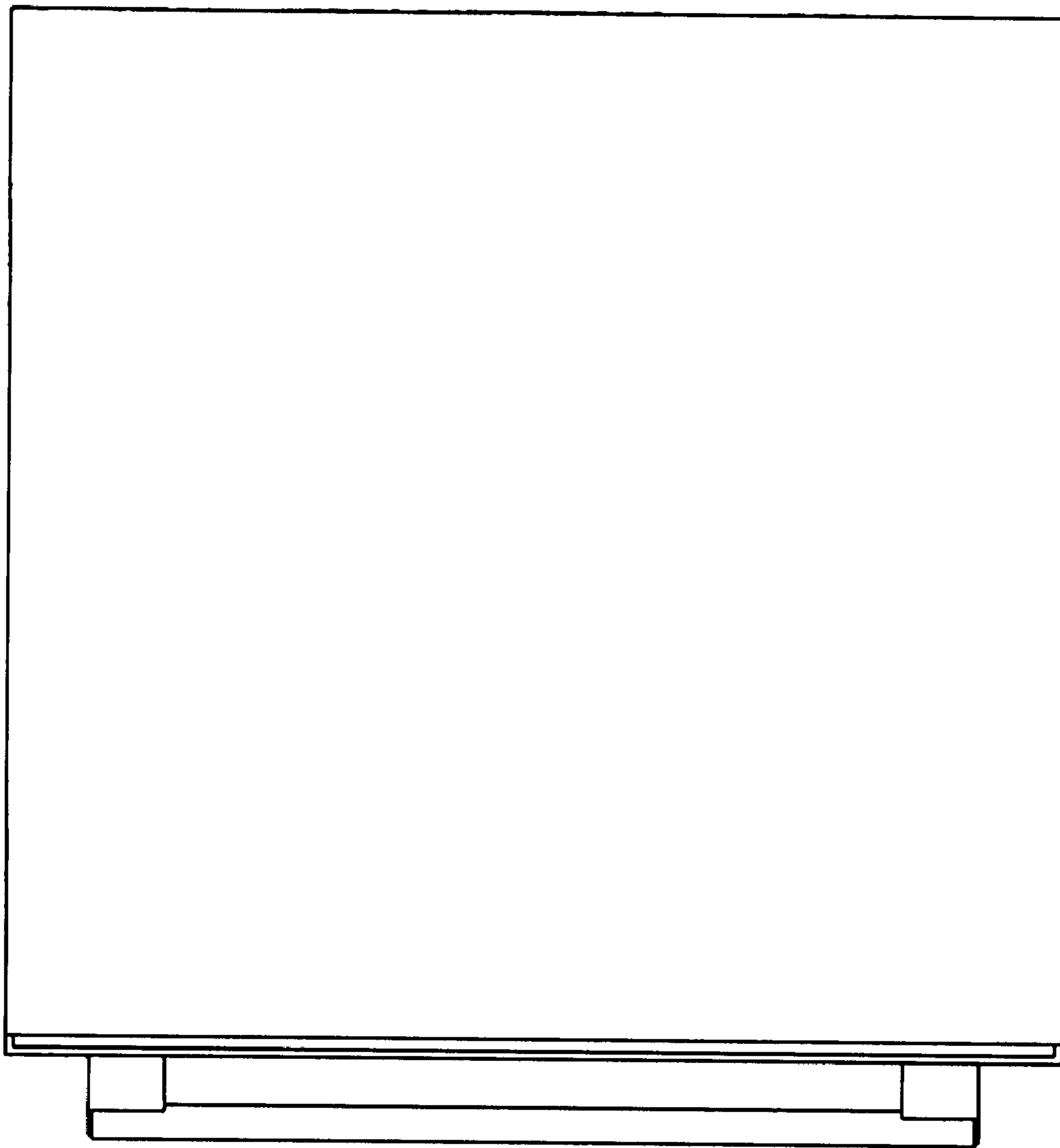

FIG. 7

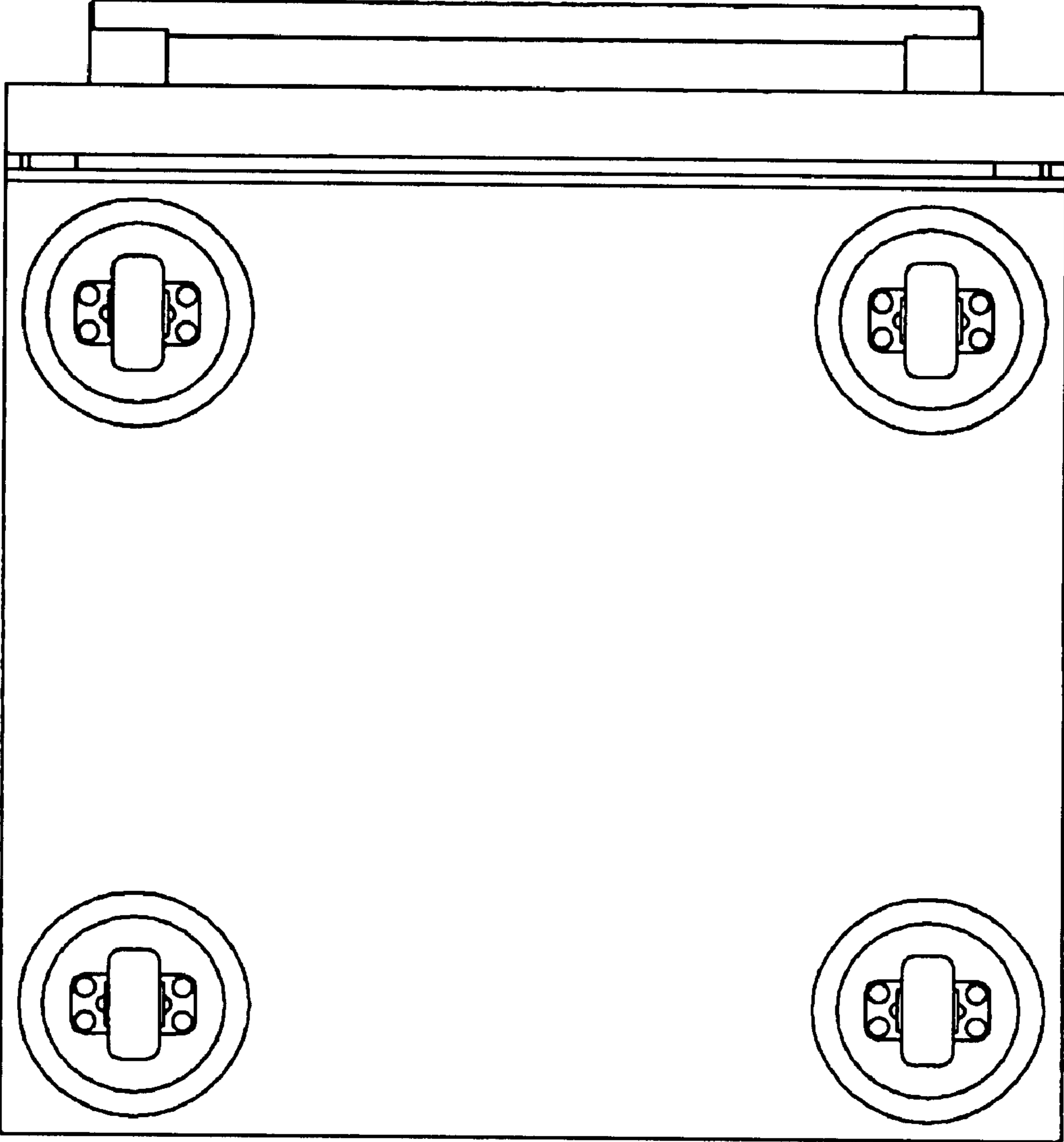

FIG. 8

