

US00D543254S

(12) **United States Design Patent**  
**Barez et al.**

(10) **Patent No.:** **US D543,254 S**

(45) **Date of Patent:** **\*\* May 22, 2007**

(54) **GOLF CLUB HEAD**  
  
(75) Inventors: **Craig Kevin Barez**, Temecula, CA (US); **Todd P. Beach**, San Diego, CA (US); **Joseph Henry Hoffman**, Carlsbad, CA (US); **Robert Nunez**, San Pedro, CA (US); **Allan Capili Saliba**, Oceanside, CA (US); **Sean Toulon**, Vista, CA (US); **Thomas Olsavsky**, Oceanside, CA (US)

(73) Assignee: **Taylor Made Golf Company, Inc.**, Carlsbad, CA (US)

(\*\*) Term: **14 Years**

(21) Appl. No.: **29/268,263**

(22) Filed: **Nov. 1, 2006**

**Related U.S. Application Data**

(63) Continuation of application No. 29/265,285, filed on Aug. 28, 2006, which is a continuation of application No. 29/241,307, filed on Oct. 25, 2005, now Pat. No. Des. 534,598.

(51) **LOC (8) Cl.** ..... **21-02**

(52) **U.S. Cl.** ..... **D21/759**

(58) **Field of Classification Search** ..... D21/733, D21/752, 759; 473/324-331, 343-346  
See application file for complete search history.

(56) **References Cited**

**U.S. PATENT DOCUMENTS**

D247,922 S	5/1978	Sheldon
D469,141 S	1/2003	Poynor
D479,867 S	9/2003	Saliba et al.
D482,093 S	11/2003	Imamoto

D499,158 S	11/2004	Imamoto	
D501,235 S	1/2005	Imamoto	
D513,051 S	12/2005	Barez et al.	
D514,185 S	1/2006	Barez et al.	
D516,652 S	3/2006	Barez et al.	
D518,129 S	3/2006	Poynor et al.	
D519,589 S	4/2006	Barez et al.	
D520,090 S	* 5/2006	Imamoto	..... D21/752
D520,586 S	* 5/2006	Bingman	..... D21/759
D521,091 S	5/2006	Mahaffey et al.	
D524,892 S	* 7/2006	Wilson et al.	..... D21/759
D527,064 S	* 8/2006	Breier et al.	..... D21/752
D533,611 S	* 12/2006	Mahaffey et al.	..... D21/752

\* cited by examiner

*Primary Examiner*—Mitchell Siegel

(74) *Attorney, Agent, or Firm*—Klarquist Sparkman, LLP

(57) **CLAIM**

We claim the ornamental design for a golf club head, as shown and described.

**DESCRIPTION**

FIG. 1 is a perspective view of a golf club head, as viewed from the rear, bottom, and one side thereof, according to one embodiment.

FIG. 2 is a front elevation view of the club head of FIG. 1.

FIG. 3 is a rear elevation view of the club head of FIG. 1.

FIG. 4 is a side elevation view of the heel of the club head of FIG. 1.

FIG. 5 is a side elevation view of the toe of the club head of FIG. 1.

FIG. 6 is a top plan view of the club head of FIG. 1; and,

FIG. 7 is a bottom plan view of the club head of FIG. 1.

The dashed lines in the drawings are for illustrative purposes only and form no part of the claimed design.

**1 Claim, 3 Drawing Sheets**

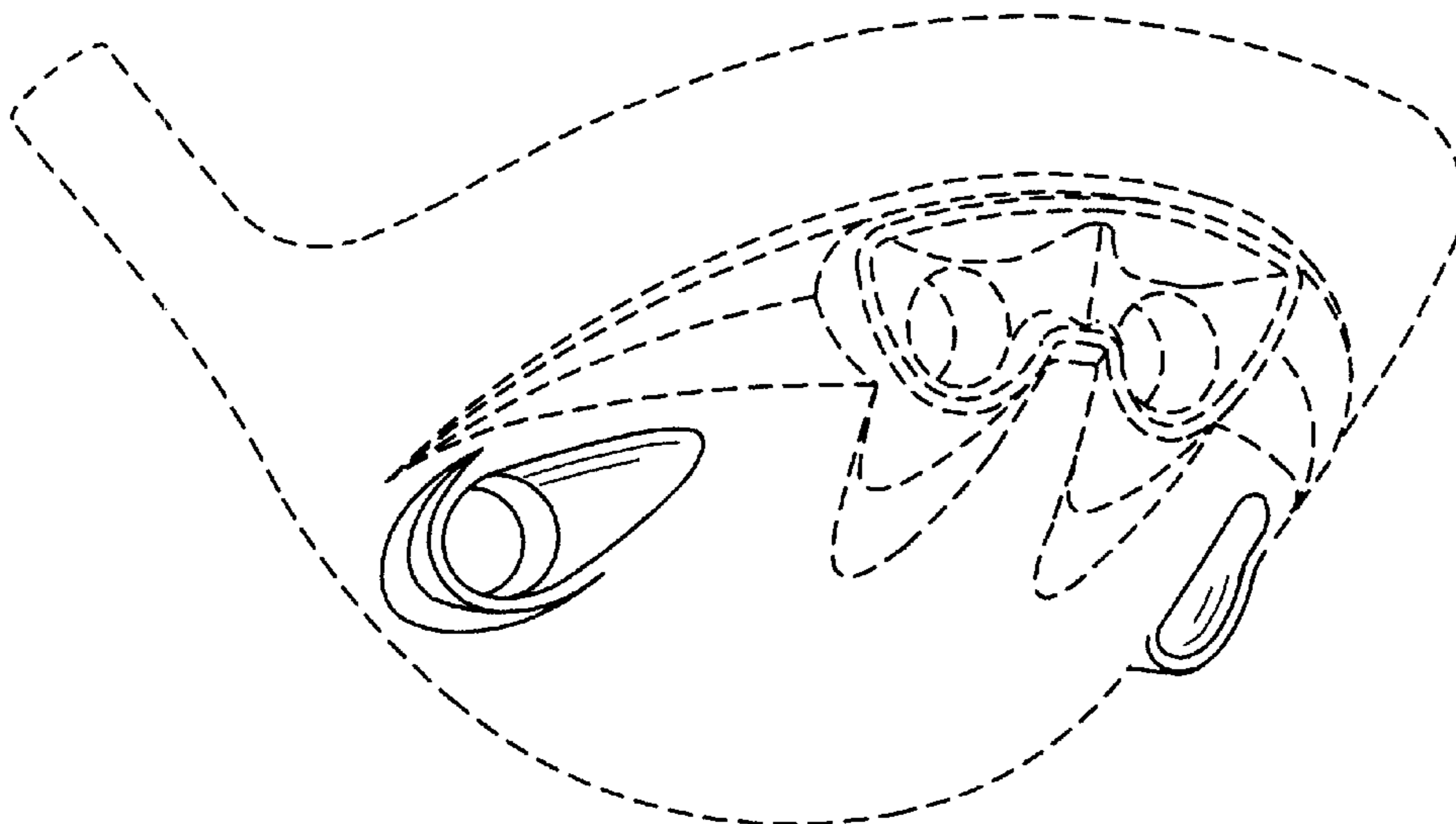

FIG. 1

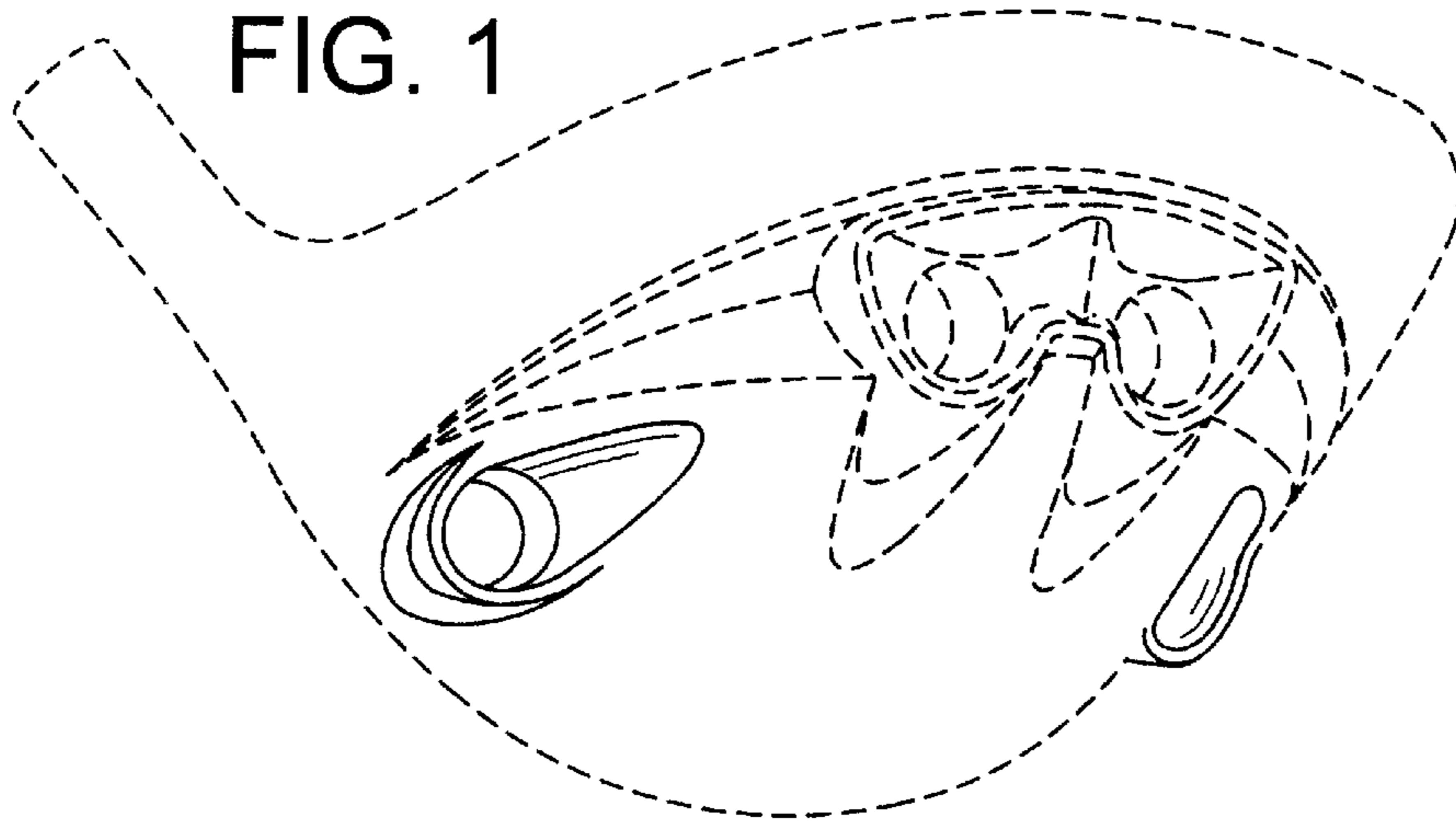

FIG. 2

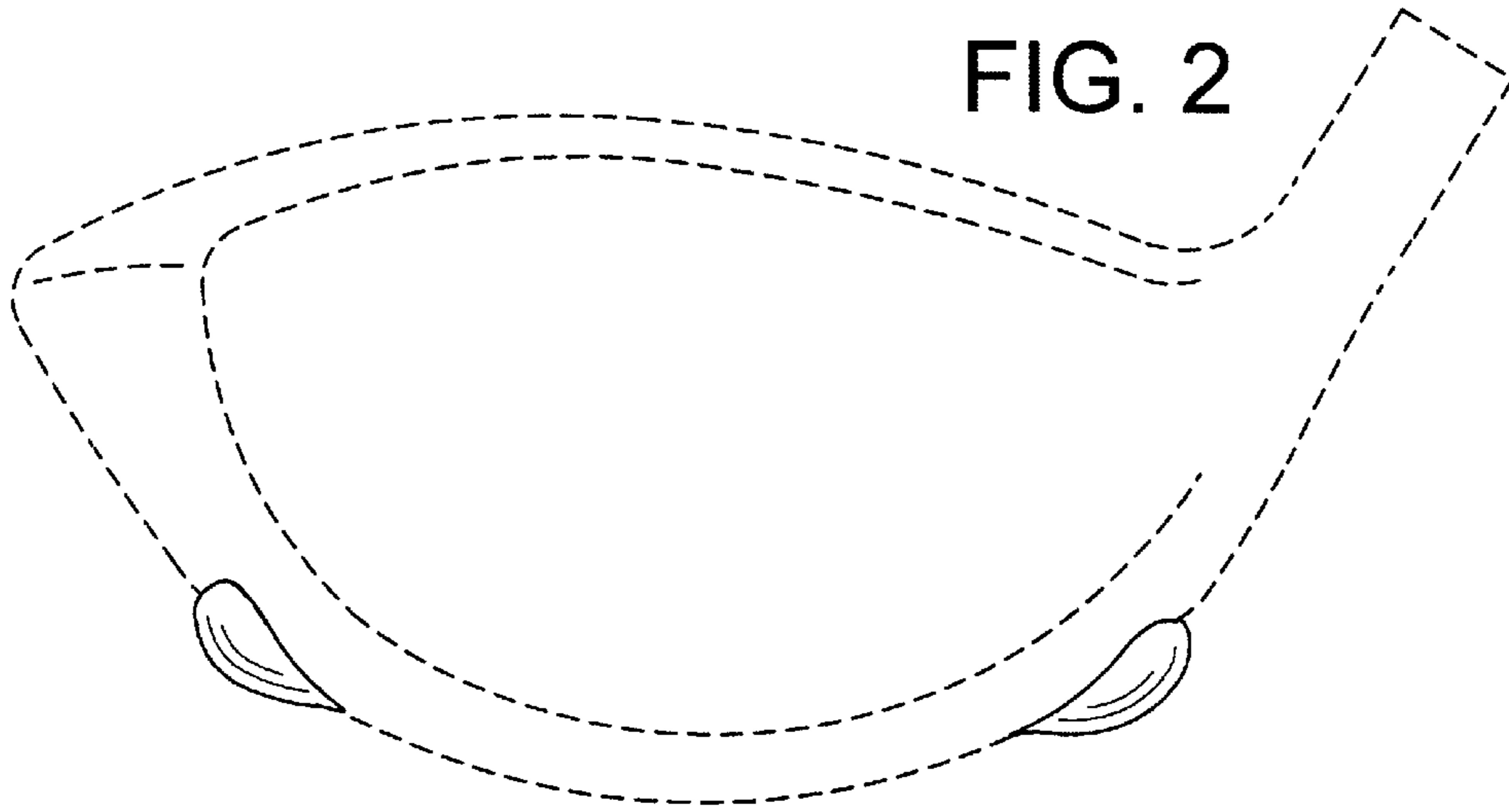
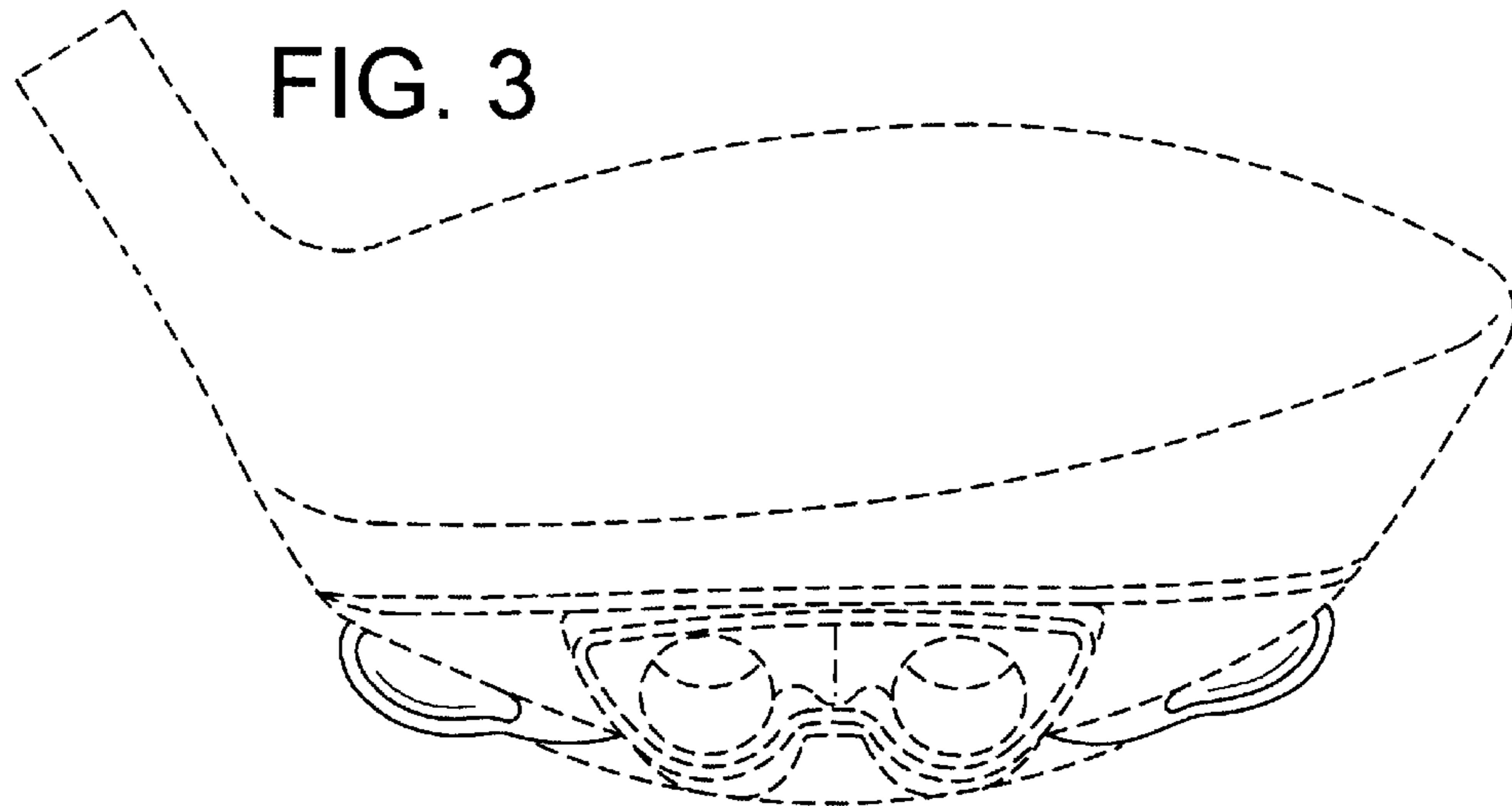
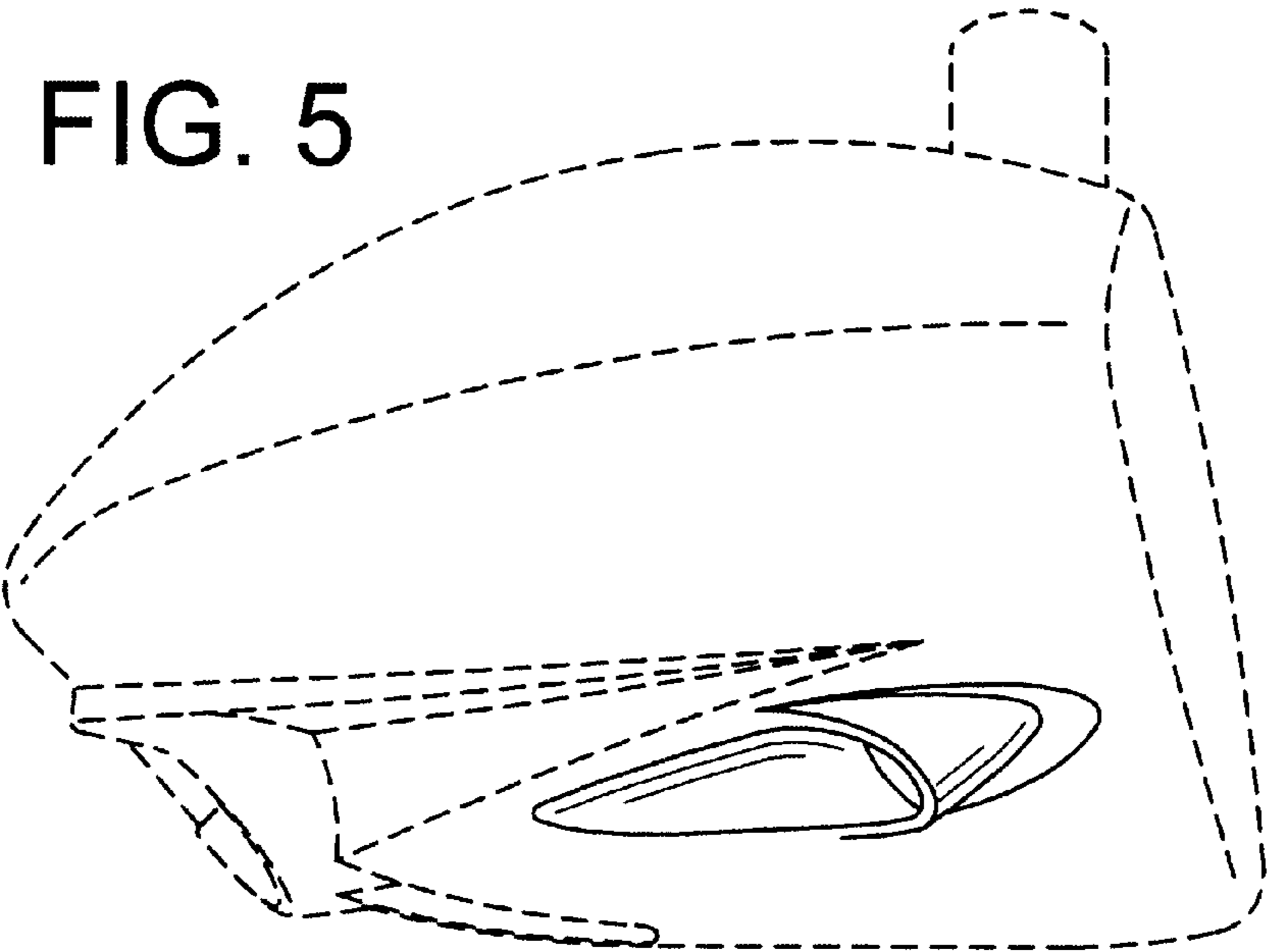
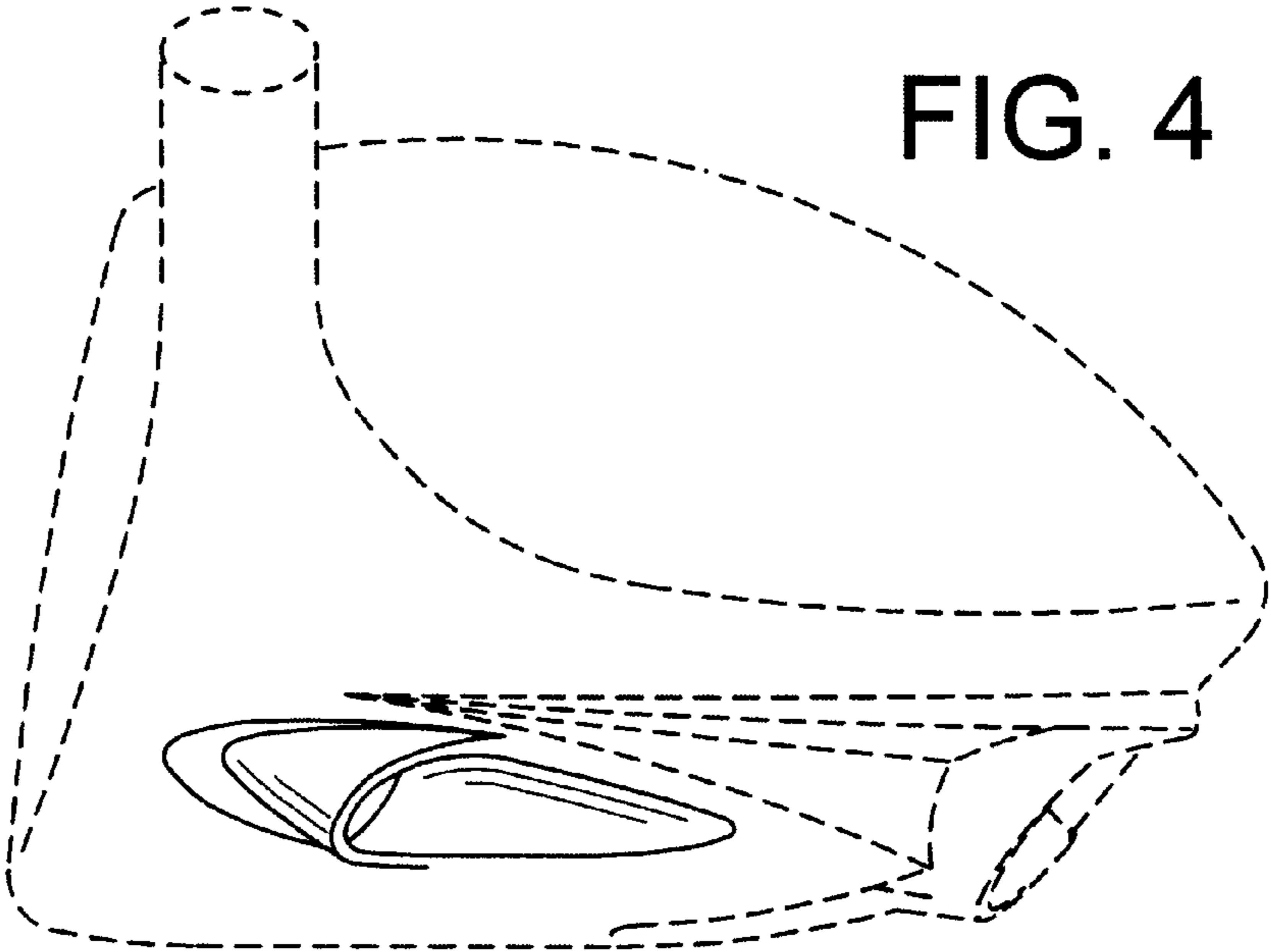

FIG. 3





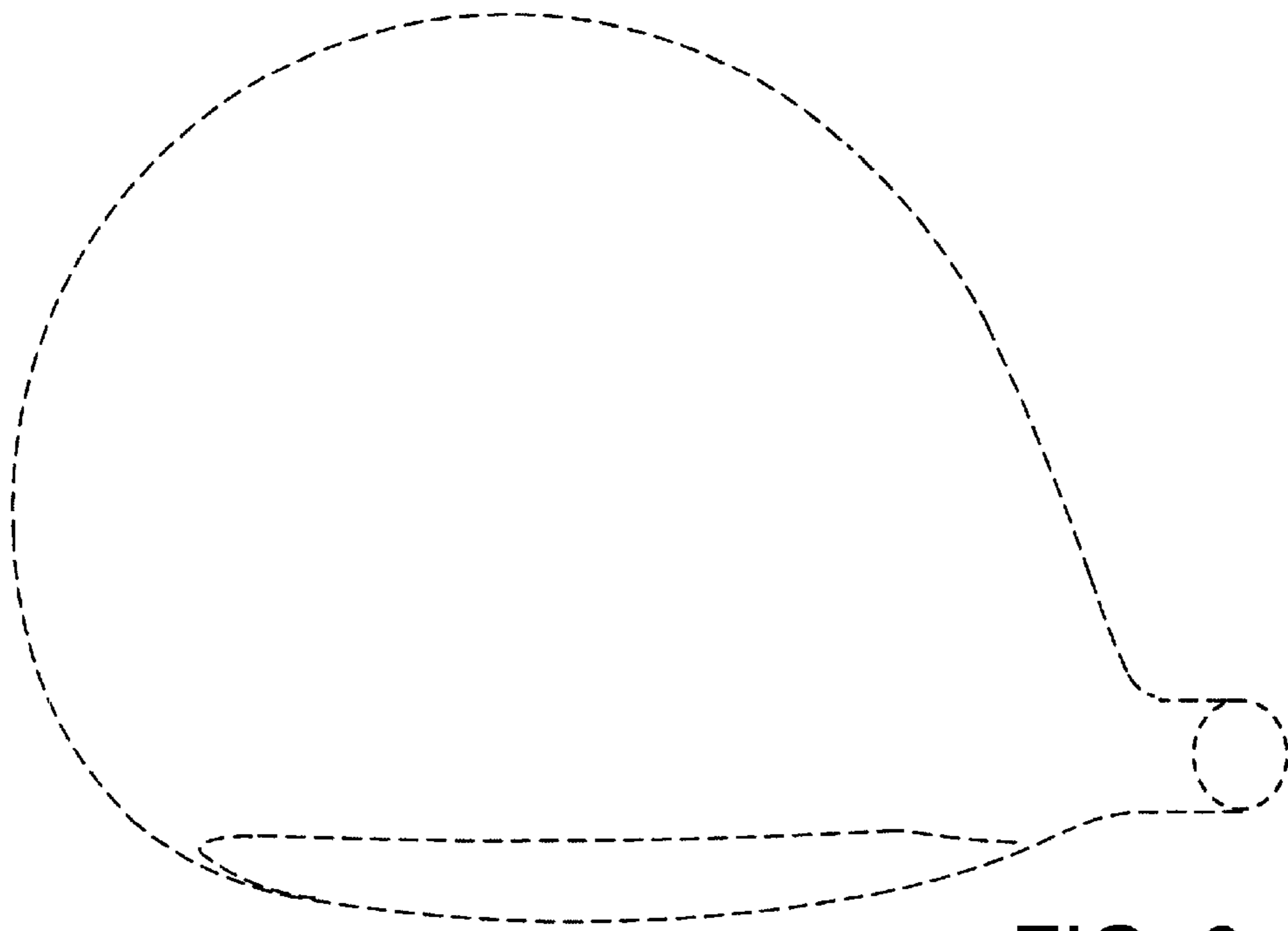

FIG. 6

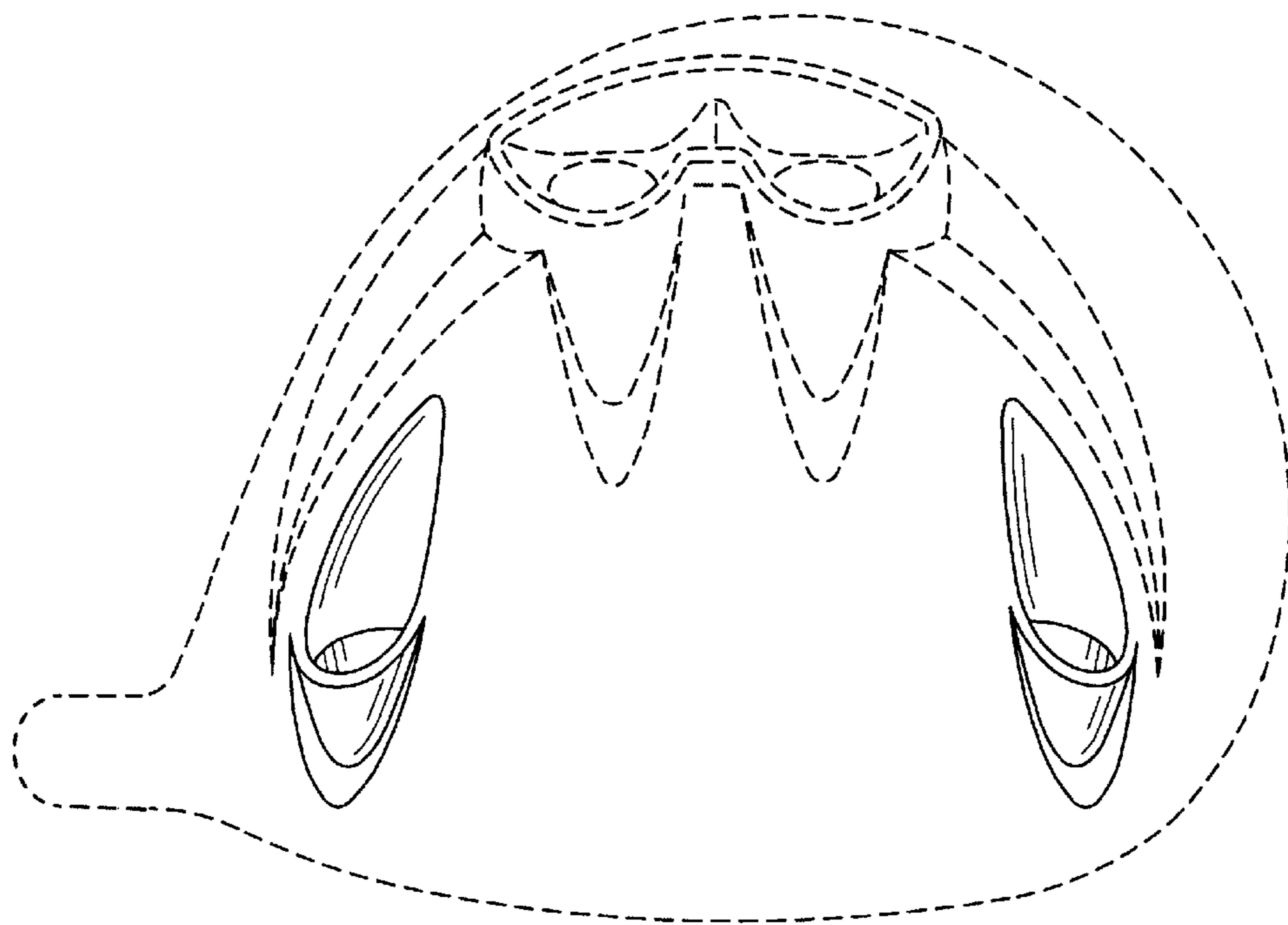

FIG. 7