

US00D543247S

(12) **United States Design Patent**  
**Luciano, Jr. et al.**

(10) **Patent No.:** **US D543,247 S**

(45) **Date of Patent:** **\*\* May 22, 2007**

(54) **UNIVERSAL BUTTON MODULE**

(75) Inventors: **Robert A. Luciano, Jr.**, Reno, NV  
(US); **Michael J. Mitchell**, Las Vegas,  
NV (US)

(73) Assignee: **Bally Gaming International, Inc.**, Las  
Vegas, NV (US)

(\*\*) Term: **14 Years**

(21) Appl. No.: **29/227,661**

(22) Filed: **Apr. 14, 2005**

(51) **LOC (8) Cl.** ..... **21-01**

(52) **U.S. Cl.** ..... **D21/385; D21/369; D13/171**

(58) **Field of Classification Search** ..... **D8/350;**

**D13/168, 171; D21/369-370, 385; 200/314-315,**  
**200/341, 520, 530, 552; 463/37, 46-47**

See application file for complete search history.

(56) **References Cited**

**U.S. PATENT DOCUMENTS**

3,267,926 A \* 8/1966 Prince ..... 200/314  
D317,137 S \* 5/1991 Kulikowski et al. .... D10/108  
5,853,326 A \* 12/1998 Goto et al. .... 463/37  
D406,568 S \* 3/1999 Harmuth et al. .... D13/168  
6,365,855 B1 \* 4/2002 Sutter et al. .... 200/314  
D516,045 S \* 2/2006 Street ..... D13/171

D519,570 S \* 4/2006 Amaitis et al. .... D21/370  
2005/0150753 A1 \* 7/2005 Hsu ..... 200/314

\* cited by examiner

*Primary Examiner*—Sandra L. Morris

(74) *Attorney, Agent, or Firm*—Steptoe & Johnson LLP

(57) **CLAIM**

The ornamental design for a universal button module, as shown and described.

**DESCRIPTION**

FIG. 1 is a front perspective view of a universal button module showing our new design;

FIG. 2 is a top planar view thereof;

FIG. 3 is a front elevational view thereof;

FIG. 4 is a side elevational view thereof;

FIG. 5 is perspective view of another embodiment, showing the design in use;

FIG. 6 is a front perspective view of another embodiment thereof;

FIG. 7 is a top planar view thereof;

FIG. 8 is a front elevational view thereof; and,

FIG. 9 is a side elevational view thereof.

The broken line showing of the button display in all figures and the gaming device in FIG. 5 is for illustrative purposes only, and forms no part of the claimed design.

**1 Claim, 3 Drawing Sheets**

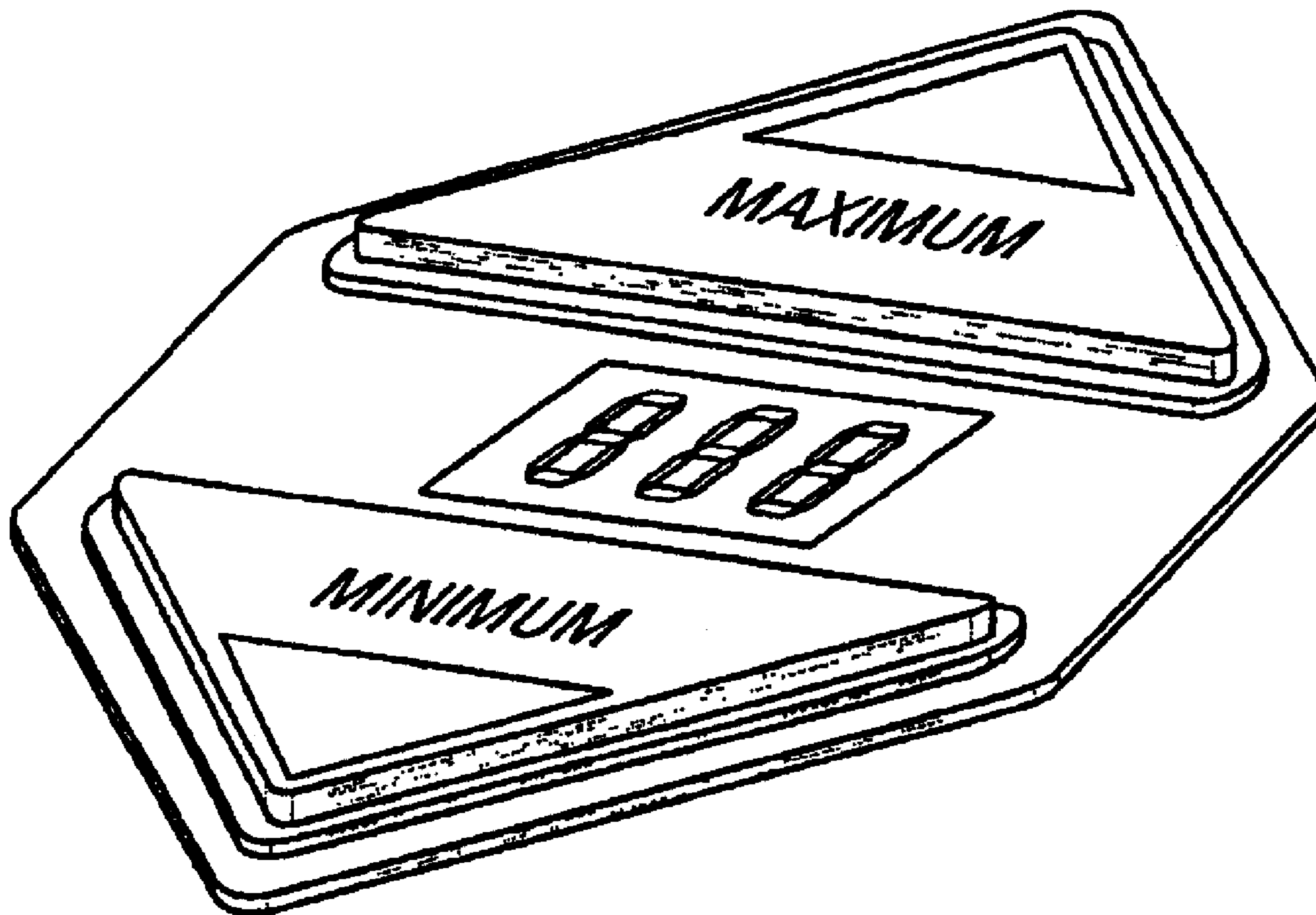

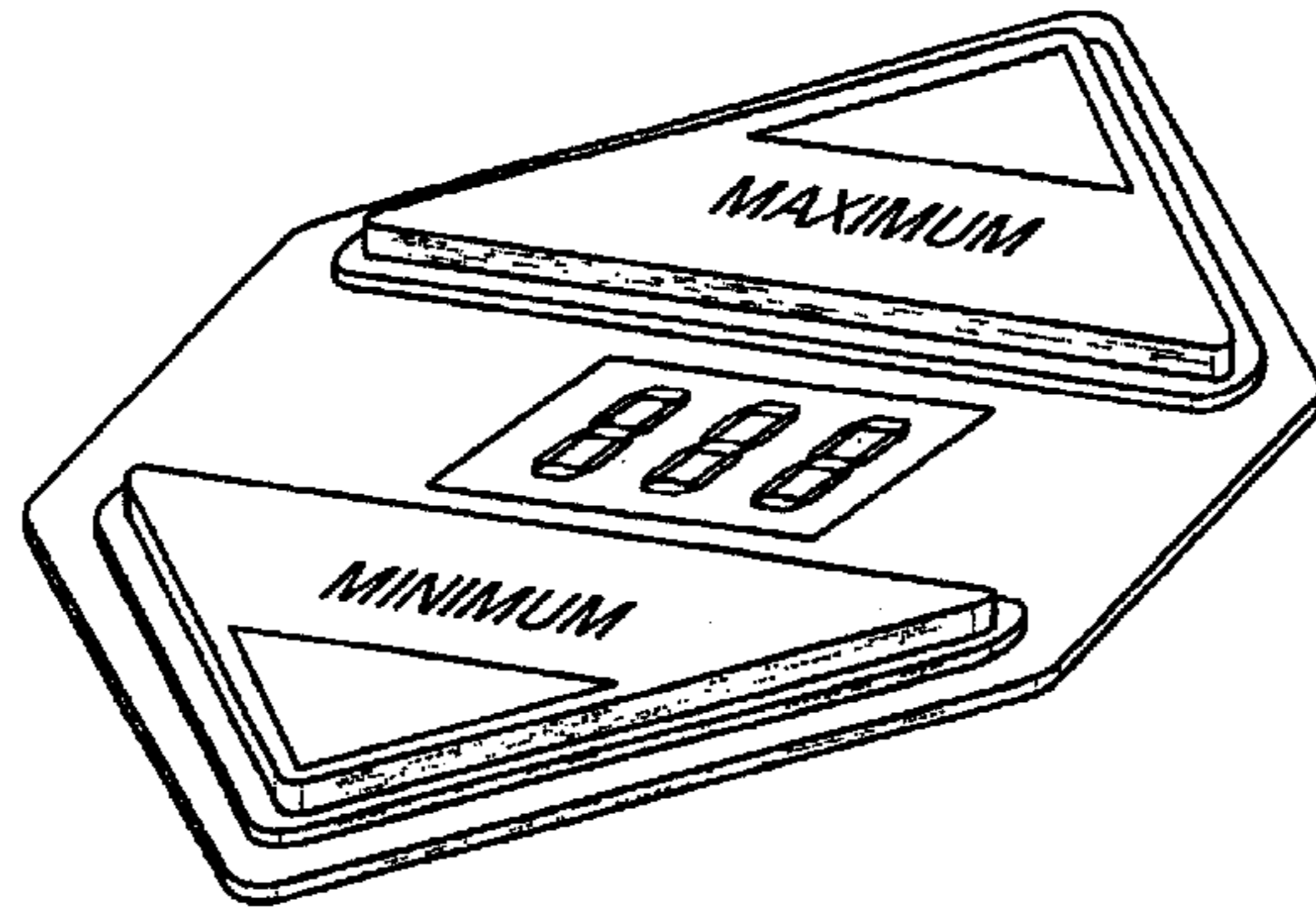

FIG. 1

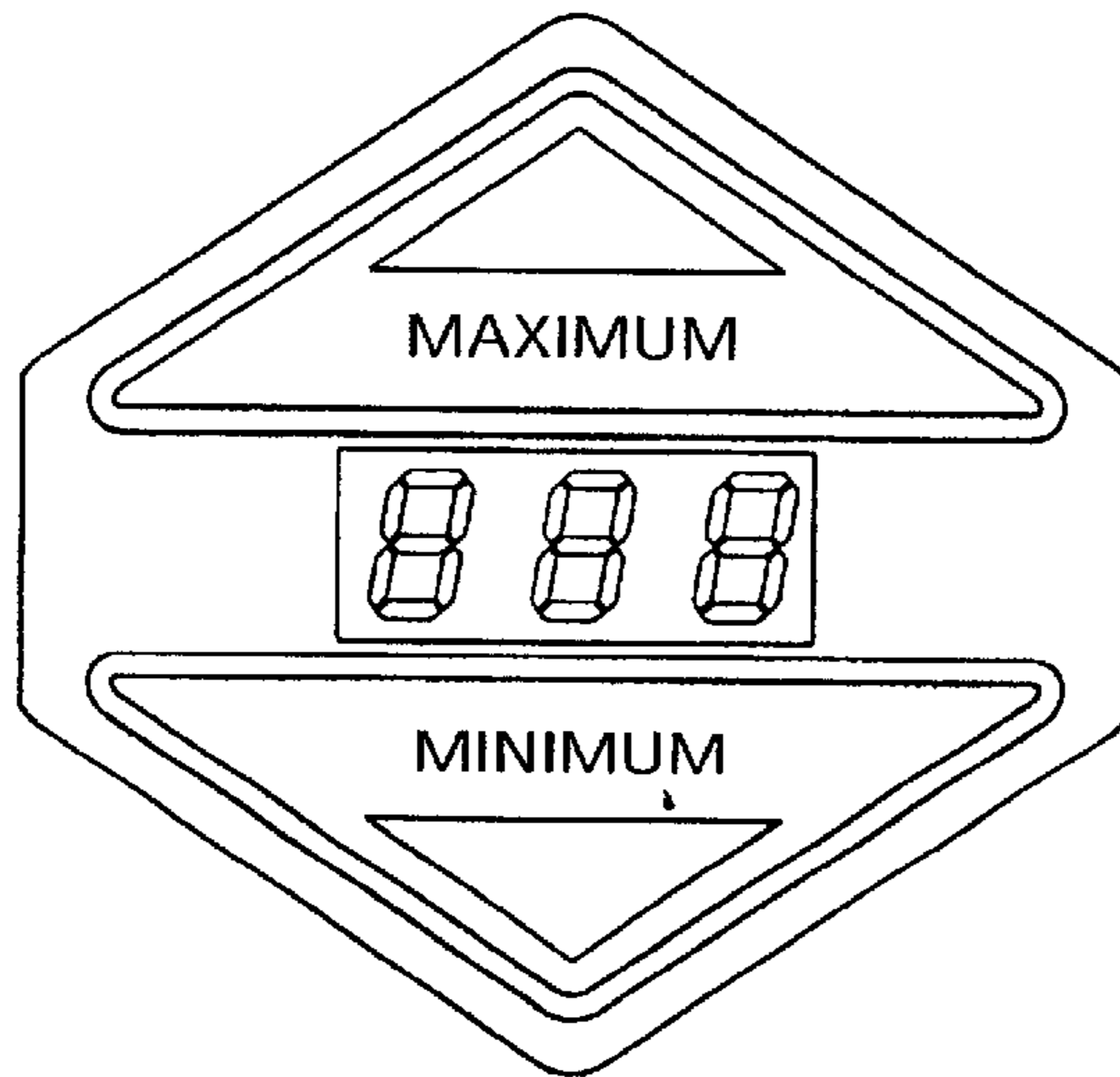

FIG. 2

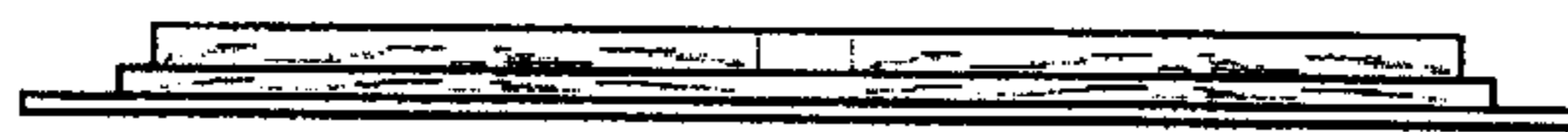

FIG. 3



FIG. 4

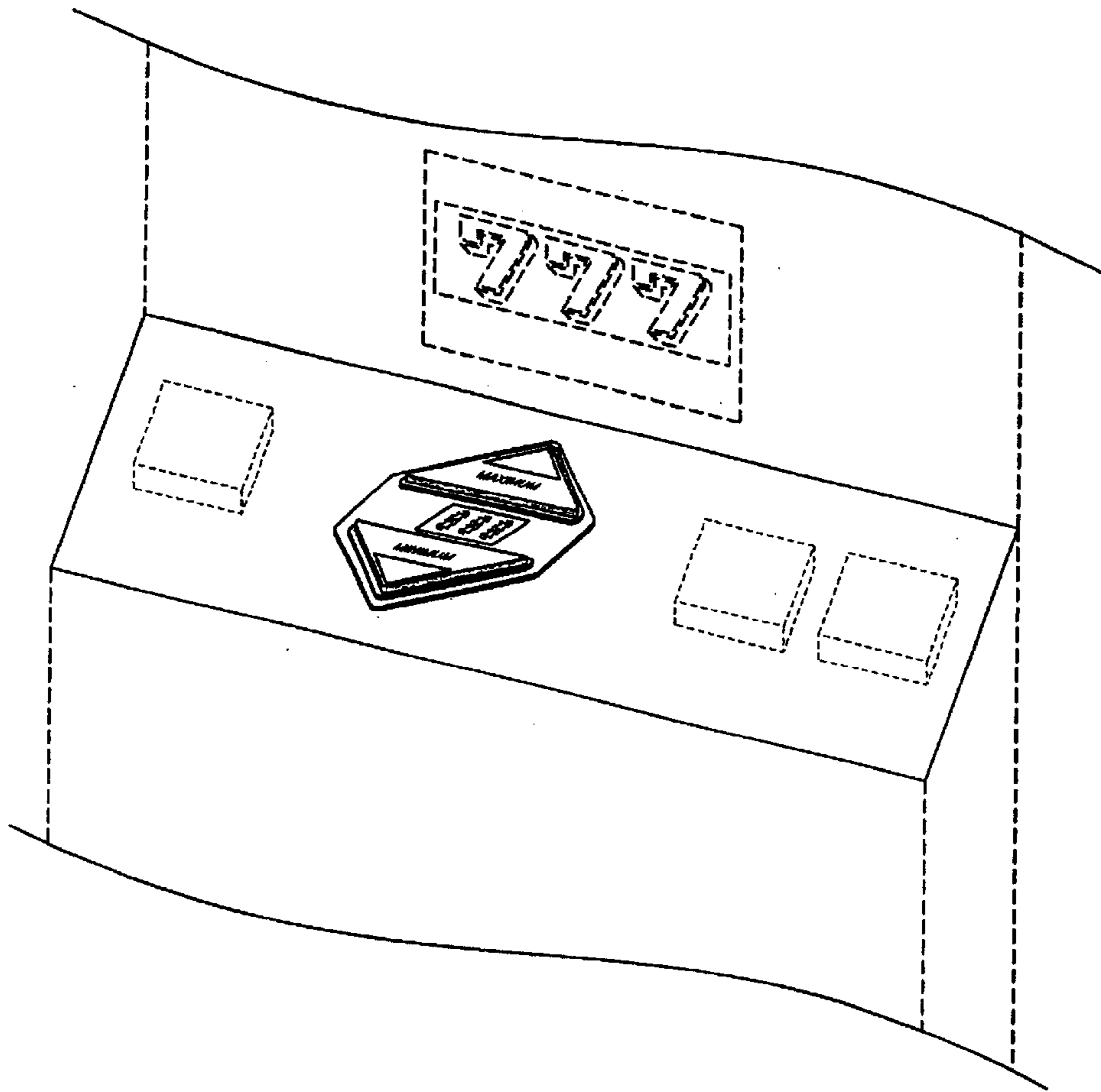

FIG. 5

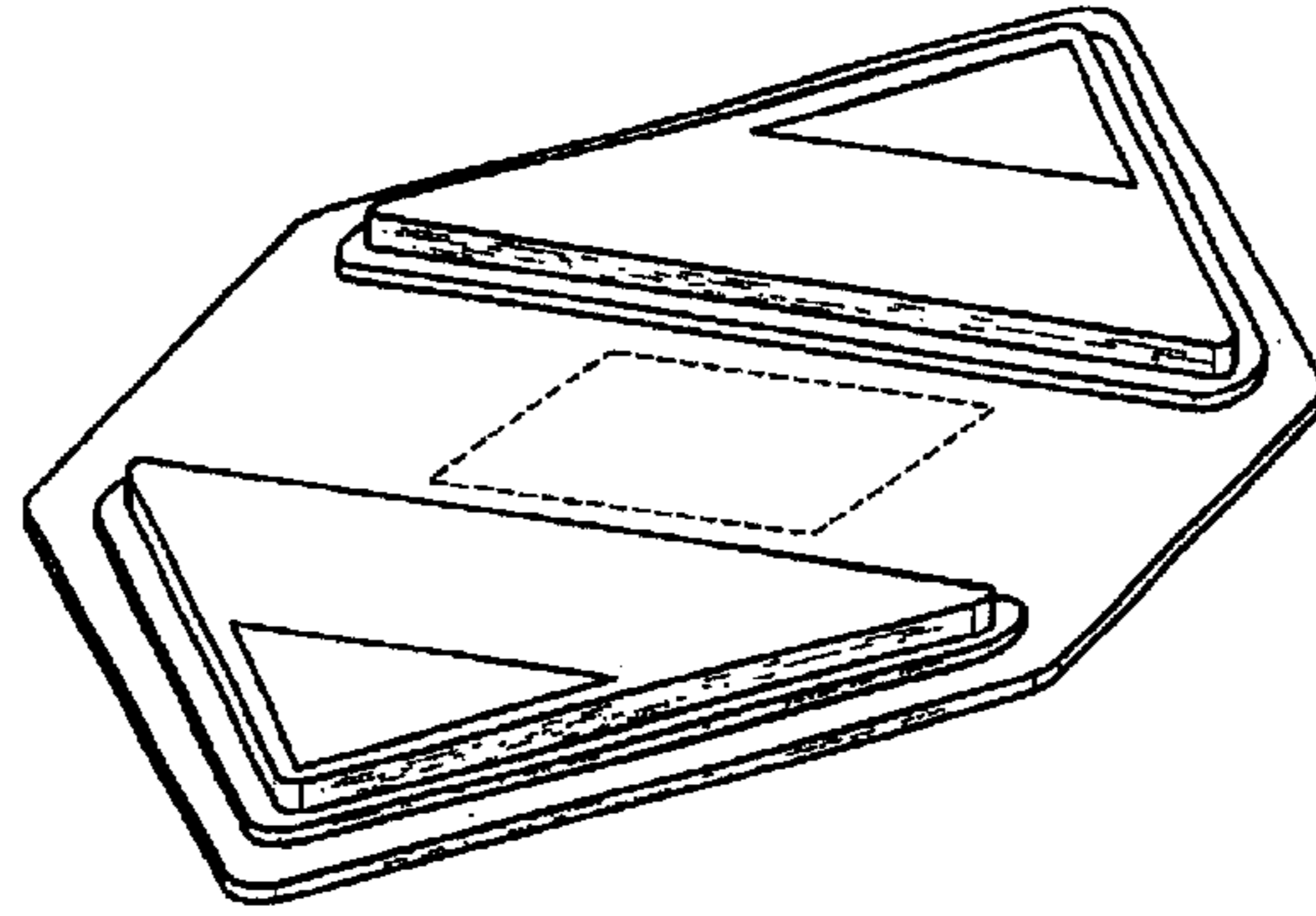

FIG. 6

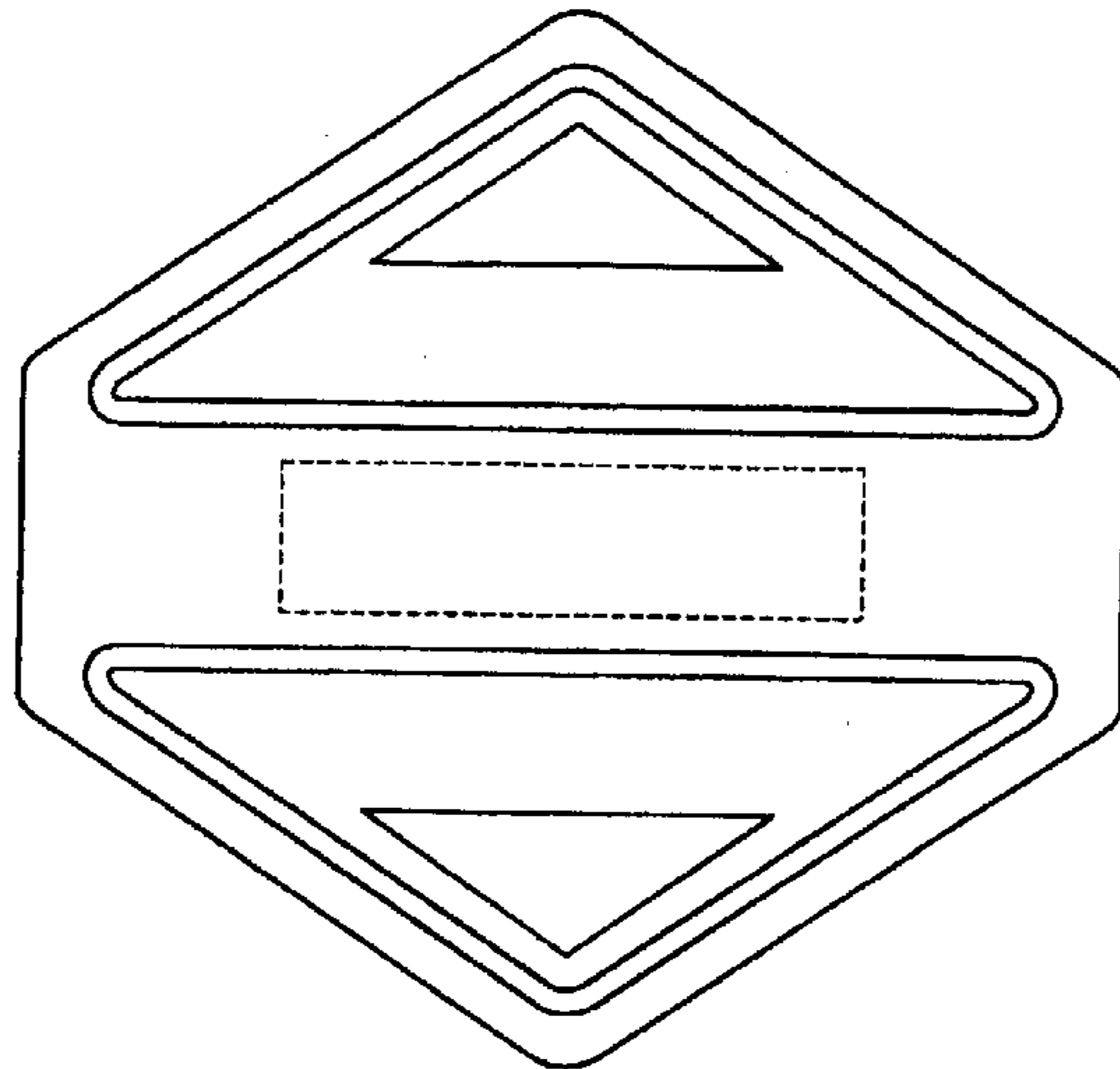

FIG. 7

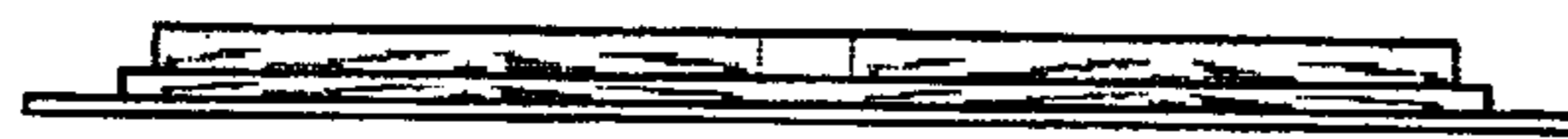

FIG. 8



FIG. 9