

US00D543177S

(12) **United States Design Patent**
Kim et al.

(10) **Patent No.:** **US D543,177 S**
(45) **Date of Patent:** **** May 22, 2007**

(54) **MOBILE COMMUNICATIONS DEVICE**

(75) Inventors: **Sang Beom Kim**, Durham, NC (US);
Charles C. Hunt, Wake Forest, NC
(US)

(73) Assignee: **Sony Ericsson Mobile**
Communications AB, Lund (SE)

(**) Term: **14 Years**

(21) Appl. No.: **29/244,680**

(22) Filed: **Dec. 13, 2005**

(51) **LOC (8) Cl.** **14-03**

(52) **U.S. Cl.** **D14/138**

(58) **Field of Classification Search** D14/137,
D14/138, 147, 218, 341-347; 455/90.3, 575.1,
455/575.3, 575.4; 379/433.01-433.13; 361/814;
348/14.02

See application file for complete search history.

(56) **References Cited**

U.S. PATENT DOCUMENTS

D433,017 S	*	10/2000	Martinez	D14/346
D436,583 S	*	1/2001	Newby et al.	D14/138
D467,918 S	*	12/2002	Fitch et al.	D14/347
D478,883 S		8/2003	Jensfelt et al.		
D479,212 S		9/2003	Eckholm		
D479,216 S	*	9/2003	Ho-Cheun et al.	D14/138
6,658,274 B1	*	12/2003	Yang	455/575.1
D485,815 S		1/2004	Edoff		
D485,819 S		1/2004	Ahlgren		
D486,458 S	*	2/2004	Chen et al.	D14/138
D492,657 S		7/2004	Jensfelt		
D492,659 S	*	7/2004	Medeiros et al.	D14/138
D493,451 S		7/2004	Wada		
D500,498 S		1/2005	Katsumata		
D502,157 S	*	2/2005	Kim et al.	D14/138
D502,158 S	*	2/2005	Miyazawa et al.	D14/138
D504,879 S	*	5/2005	Moss	D14/138
D505,932 S	*	6/2005	Eckholm et al.	D14/138
D515,532 S	*	2/2006	Shintani	D14/138
D515,533 S	*	2/2006	Yano	D14/138

D515,543 S	*	2/2006	Shintani	D14/138
D523,837 S	*	6/2006	Lee	D14/138
D524,782 S	*	7/2006	Sun et al.	D14/138
2006/0234785 A1	*	10/2006	Lee et al.	455/575.1

FOREIGN PATENT DOCUMENTS

WO DM/067110 * 9/2005

OTHER PUBLICATIONS

Motorola E365, announced 2nd quarter 2003, [online], [retrieved on Nov. 20, 2006]. Retrieved from Internet ,<URL: http://www.gsmarena.com>.*
Motorola C350, announced 1st quarter 2003, [online], [retrieved on Nov. 20, 2006]. Retrieved from Internet ,<URL: http://www.gsmarena.com>.*

(Continued)

Primary Examiner—Jeffrey Asch
Assistant Examiner—Bridget L. Eland
(74) *Attorney, Agent, or Firm*—Renner, Otto, Boisselle & Sklar, LLP.

(57) **CLAIM**

The ornamental design for a mobile communications device, as shown and described.

DESCRIPTION

FIG. 1 is a front perspective view of a mobile communications device showing our design;
FIG. 2 is a front view thereof;
FIG. 3 is a right side view thereof;
FIG. 4 is a left side view thereof;
FIG. 5 is a rear view thereof;
FIG. 6 is a top view thereof; and,
FIG. 7 is a bottom view thereof.
The solid line immediately adjacent the unshaded area that includes the broken line keypad, represent the boundary of the claimed design. The broken lines are directed to environment, and are for illustrative purposes only; The broken lines form no part of the claimed design.

1 Claim, 2 Drawing Sheets

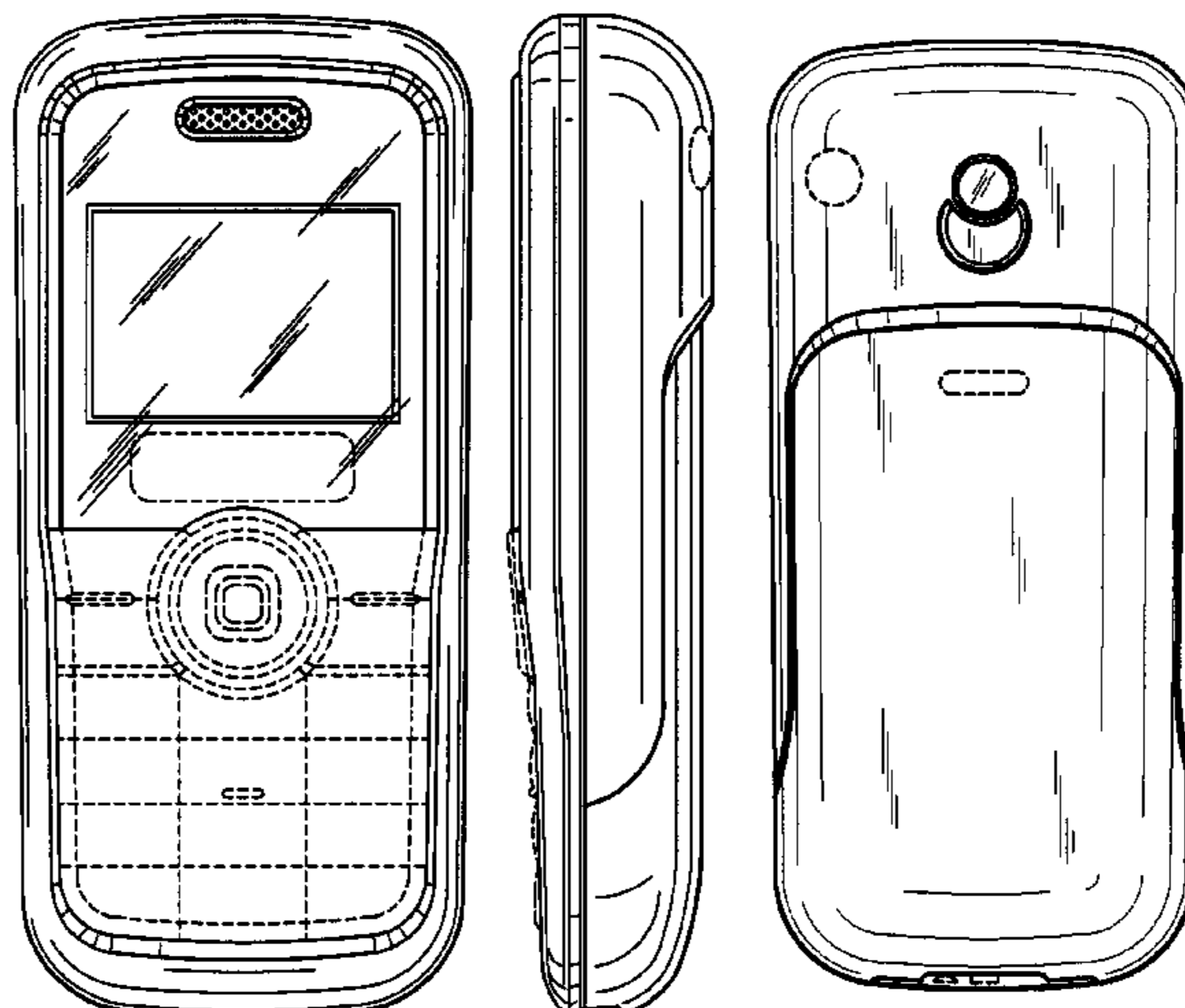

OTHER PUBLICATIONS

Sony Ericsson J100, announced Feb. 2006, [online], [retrieved on Nov. 20, 2006]. Retrieved from Internet ,<URL: <http://www.gsmarena.com>>.*

Alcatel OT-E158, announced 1st quarter 2005, [online], [retrieved on Nov. 20, 2006]. Retrieved from Internet ,<URL: <http://www.gsmarena.com>>.*

* cited by examiner

FIG. 1

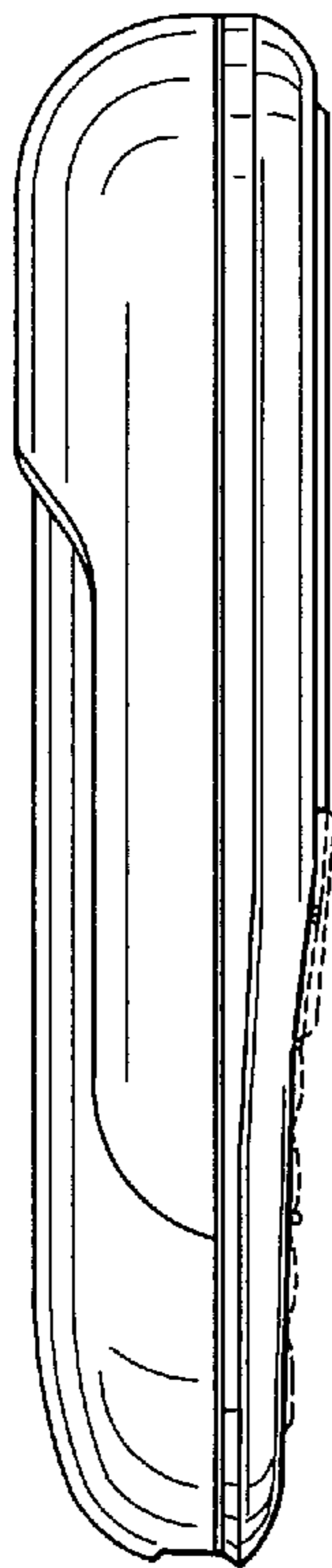
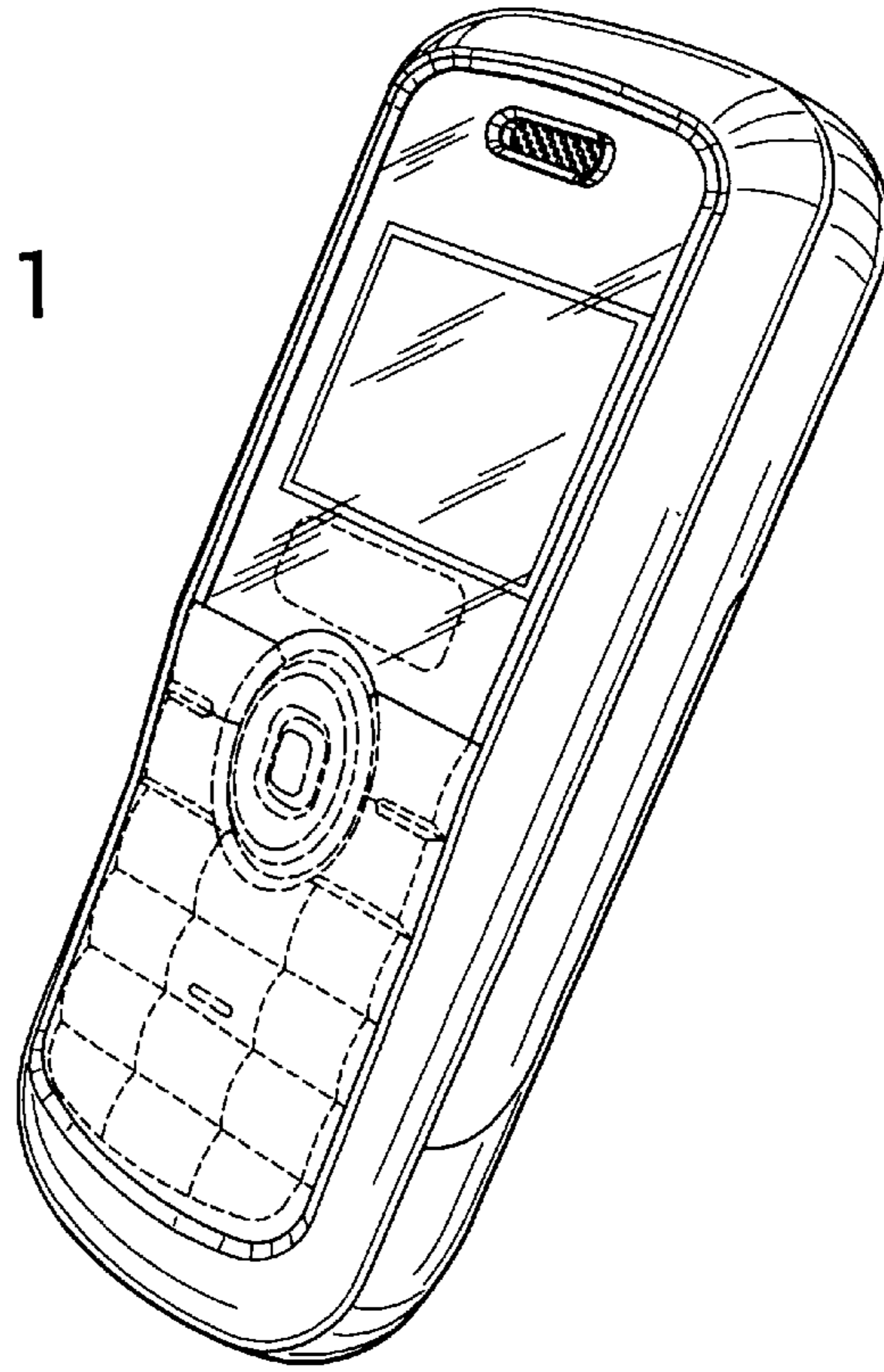

FIG. 4

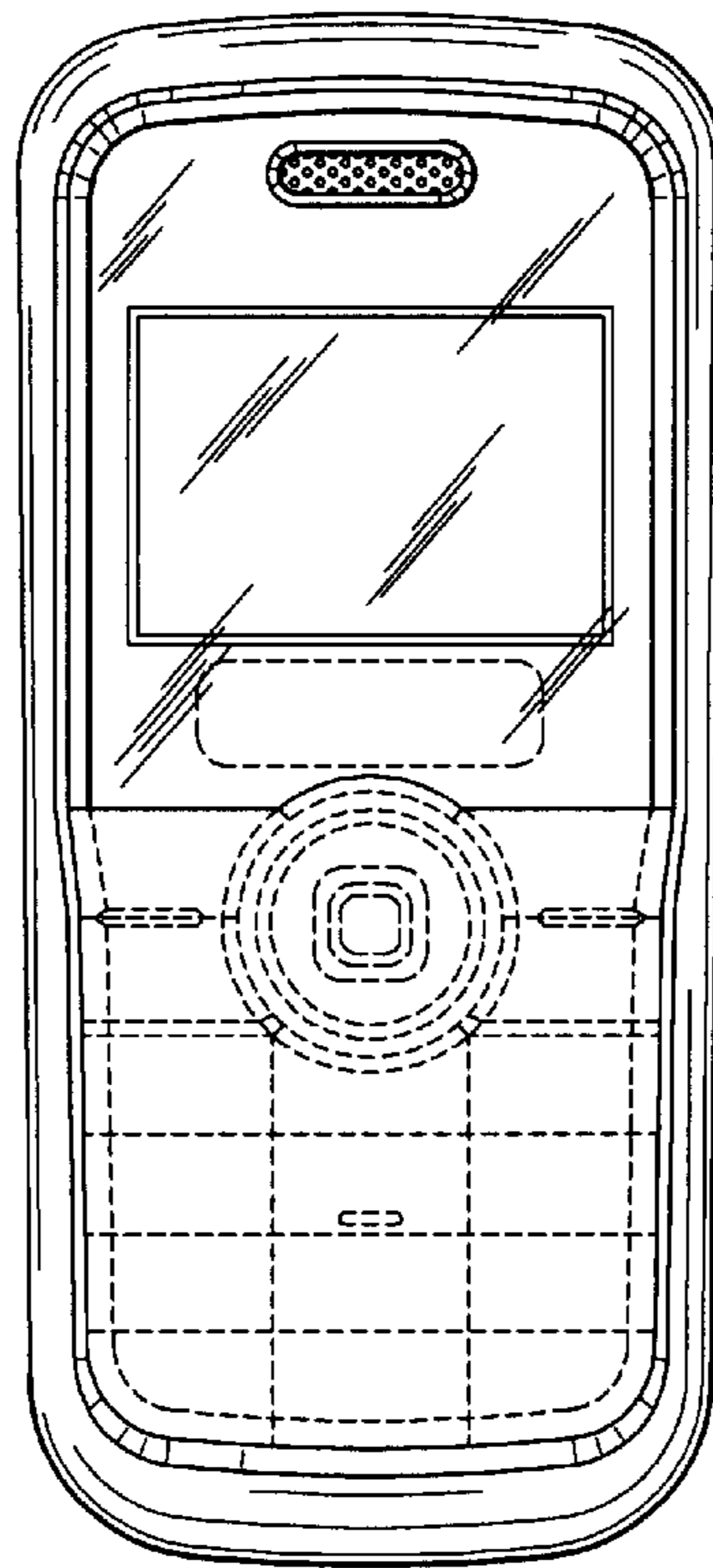

FIG. 2

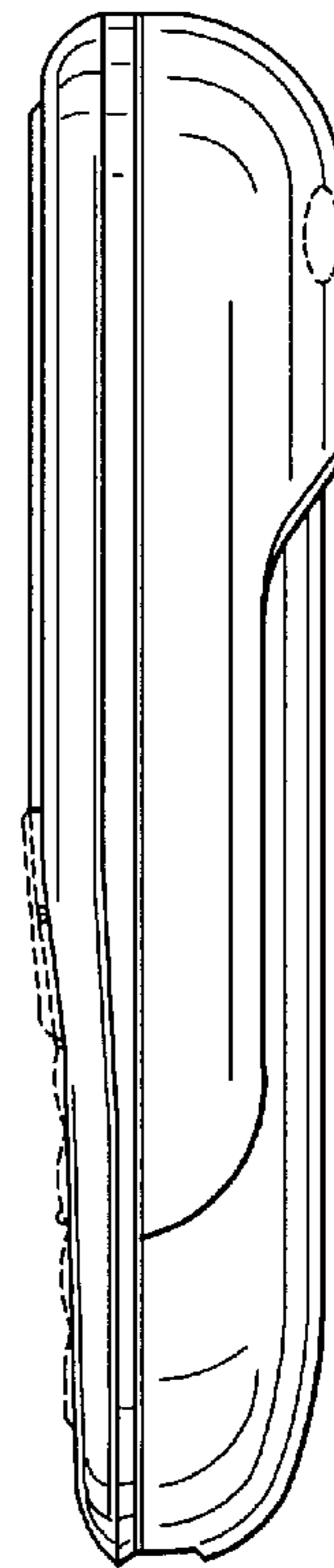

FIG. 3

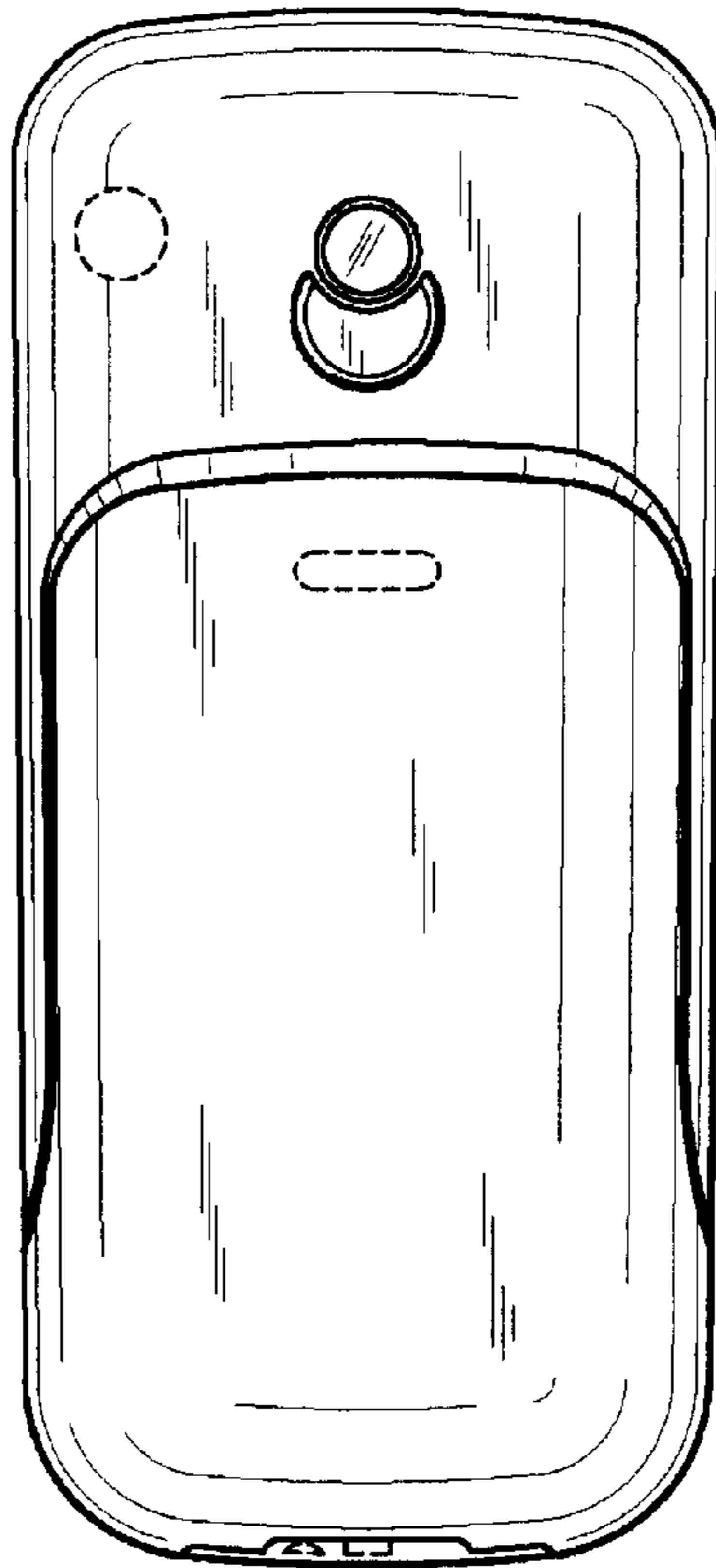

Fig.5

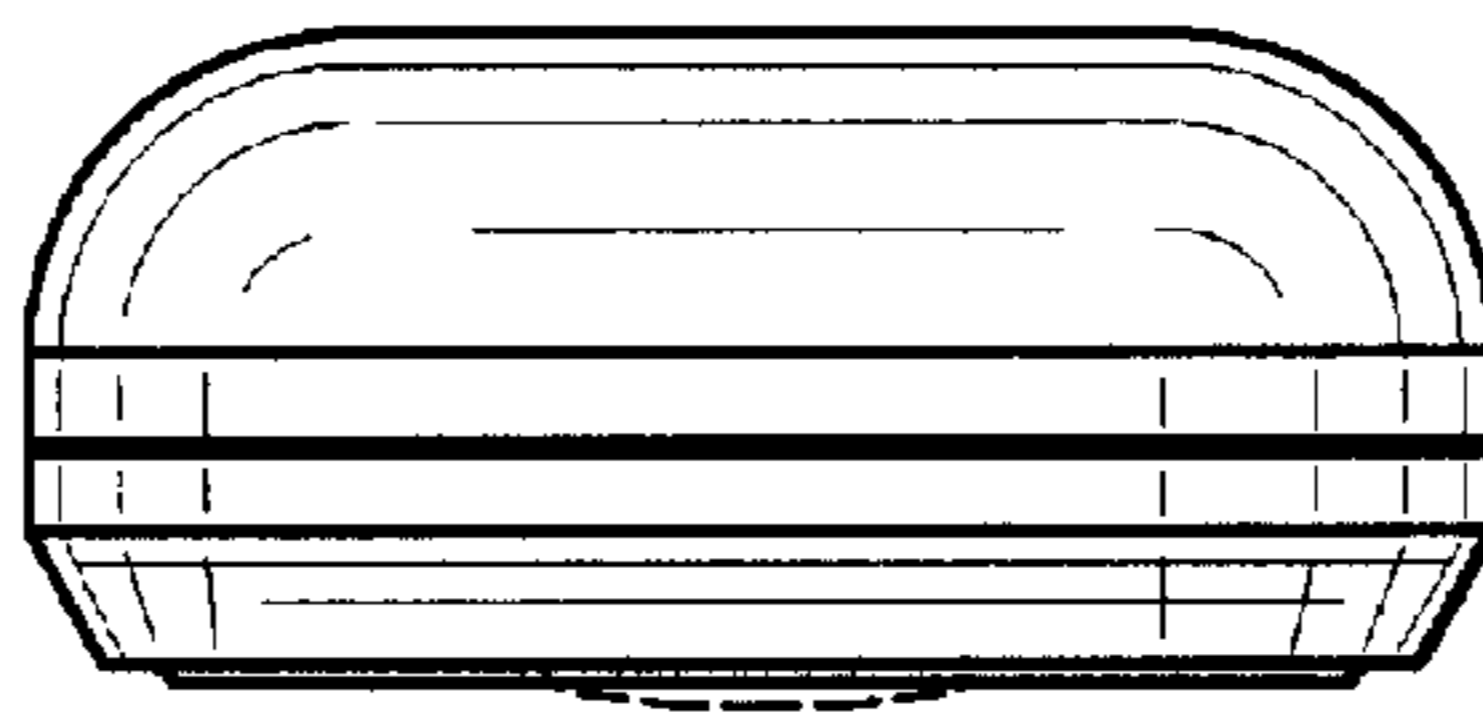

Fig.6

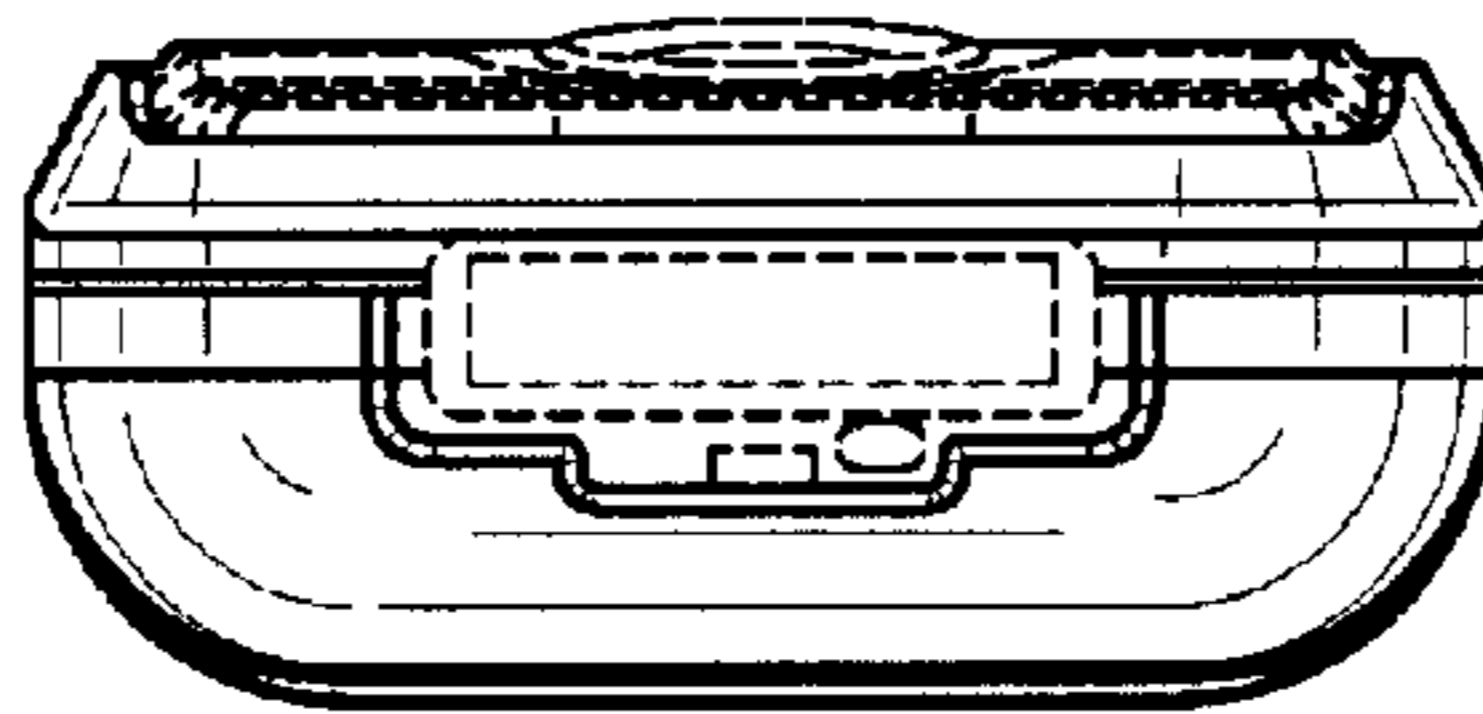

Fig.7