

US00D542985S

(12) **United States Design Patent**  
**Hinds**

(10) **Patent No.:** **US D542,985 S**

(45) **Date of Patent:** **\*\* May 15, 2007**

(54) **TOWEL AND ROBE WARMER**

(76) **Inventor:** **Dudley H. Hinds**, 230 Saybrooke St.,  
Hartford, CT (US) 06106

(\*\*) **Term:** **14 Years**

(21) **Appl. No.:** **29/251,344**

(22) **Filed:** **Jan. 9, 2006**

(51) **LOC (8) Cl.** ..... **15-05**

(52) **U.S. Cl.** ..... **D32/1**

(58) **Field of Classification Search** ..... D32/1,  
D32/6, 8, 10, 9; 219/342, 385, 521; 34/60,  
34/77, 279, 542, 621

See application file for complete search history.

(56) **References Cited**

**U.S. PATENT DOCUMENTS**

3,102,796	A *	9/1963	Erickson	.....	34/75
5,152,077	A *	10/1992	Liang	.....	34/77
D332,329	S *	1/1993	Hood et al.	.....	D32/8
5,546,678	A *	8/1996	Dhaemers	.....	34/275
6,315,039	B1 *	11/2001	Westbrooks et al.	.....	165/201

6,604,942	B2 *	8/2003	Sharp	.....	432/266
6,718,650	B2 *	4/2004	Ross	.....	34/90
2002/0129514	A1 *	9/2002	Sharp	.....	34/611
2003/0126691	A1 *	7/2003	Gerlach et al.	.....	8/158
2004/0134088	A1 *	7/2004	Meyer	.....	34/90
2006/0191901	A1 *	8/2006	Taylor et al.	.....	219/521

\* cited by examiner

*Primary Examiner*—Louis S. Zarfes

*Assistant Examiner*—Kathleen Sims

(57) **CLAIM**

I claim, the ornamental design for the towel and robe warmer, as shown.

**DESCRIPTION**

FIG. 1 is a front view of a towel and robe warmer;  
FIG. 2 is a back view of a towel and robe warmer;  
FIG. 3 is a top view of a towel and robe warmer;  
FIG. 4 is a bottom view of a towel and robe warmer;  
FIG. 5 is a right side view of a towel and robe warmer;  
FIG. 6 is a left-side view of a towel and robe warmer; and,  
FIG. 7 is perspective view of a towel and robe warmer.

**1 Claim, 4 Drawing Sheets**

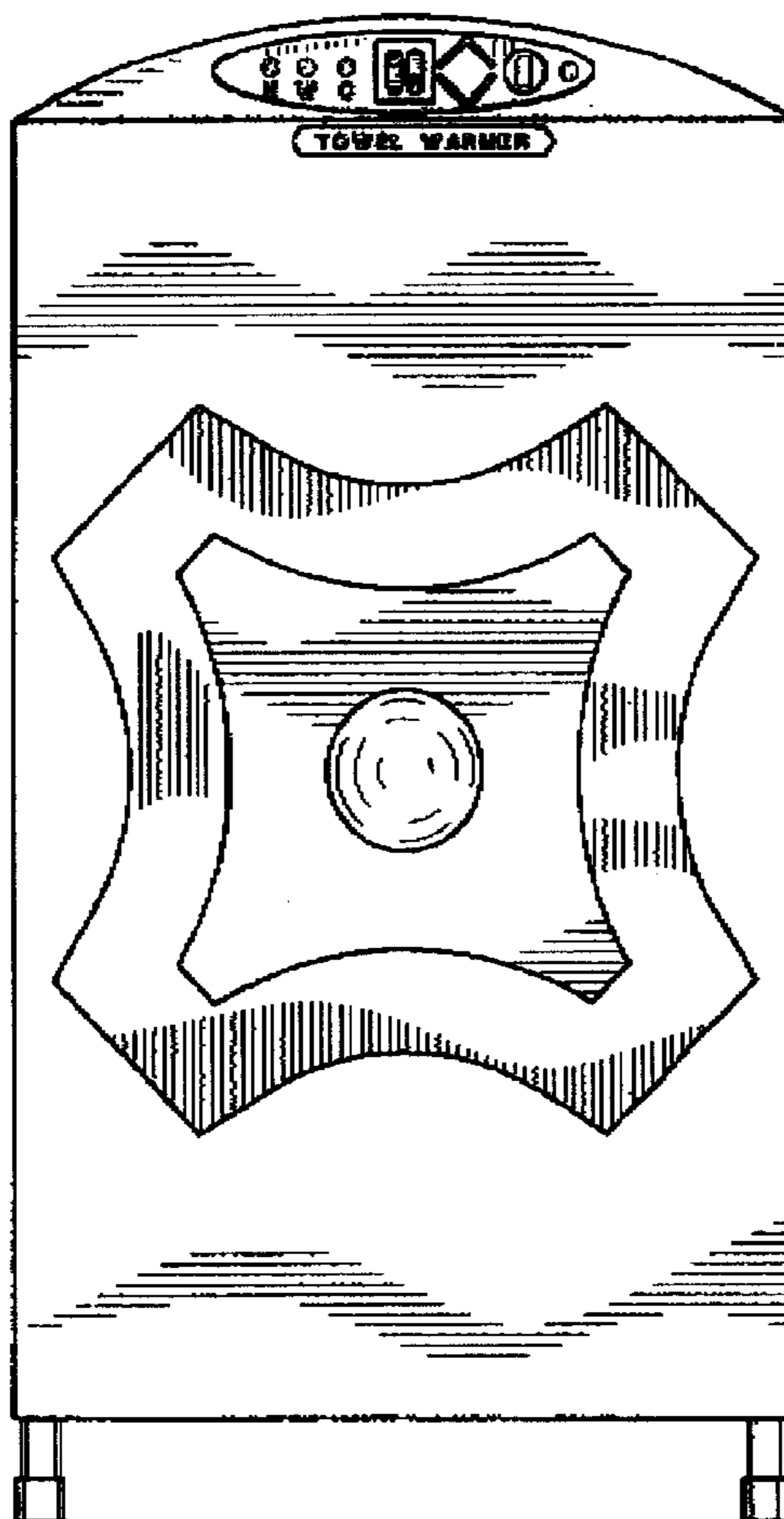

FIG. 2

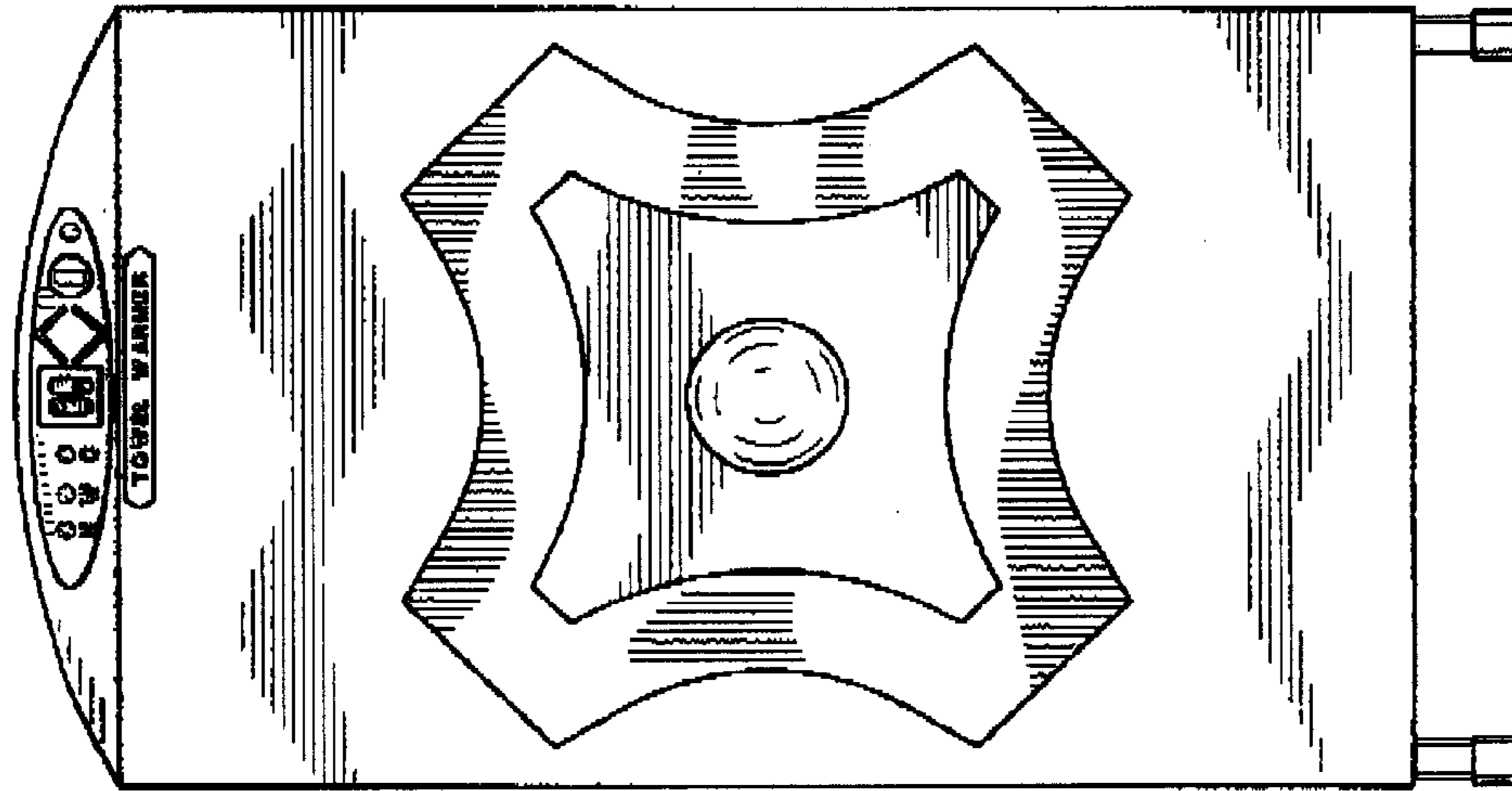
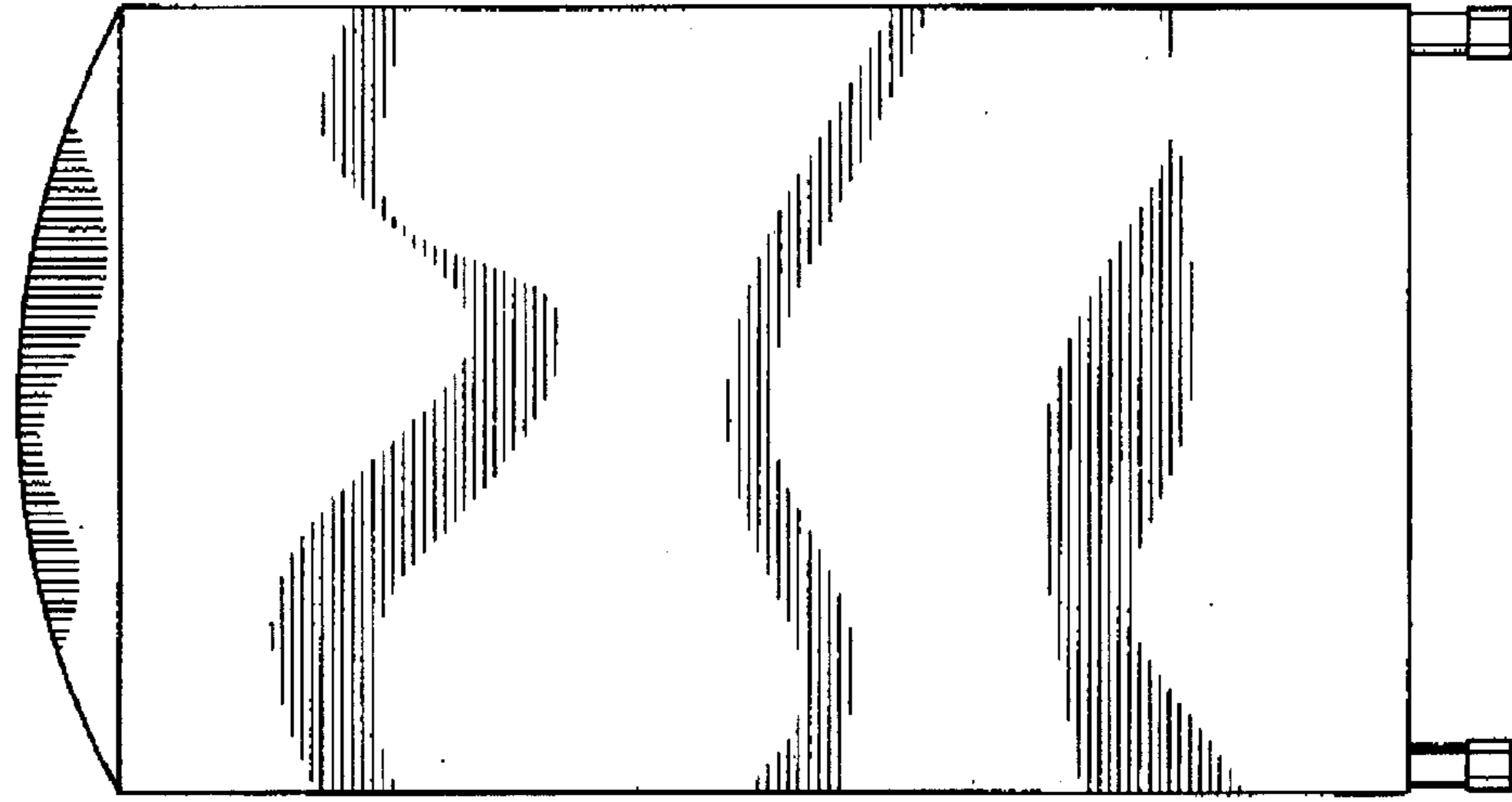

FIG. 1

FIG. 3

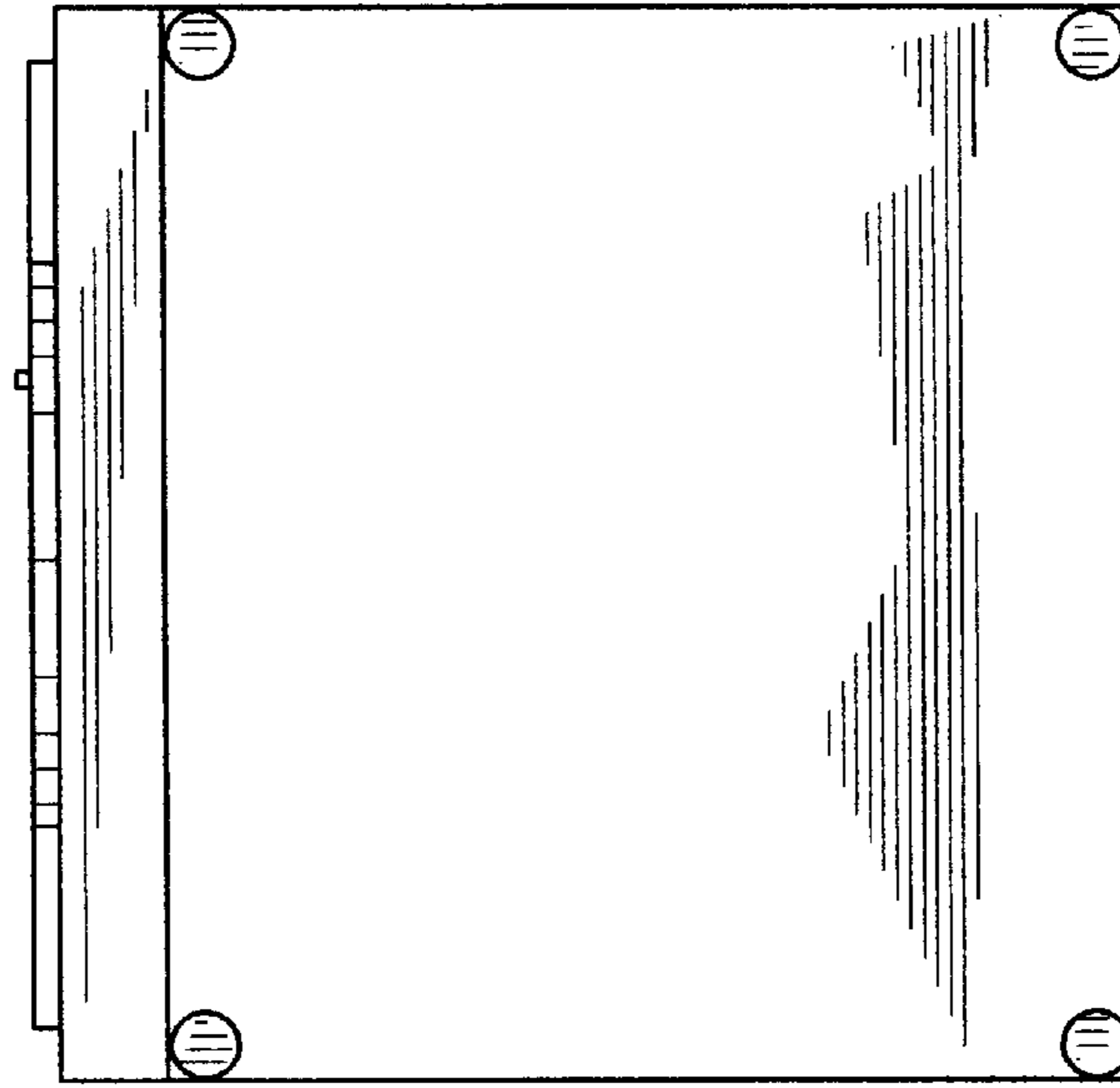
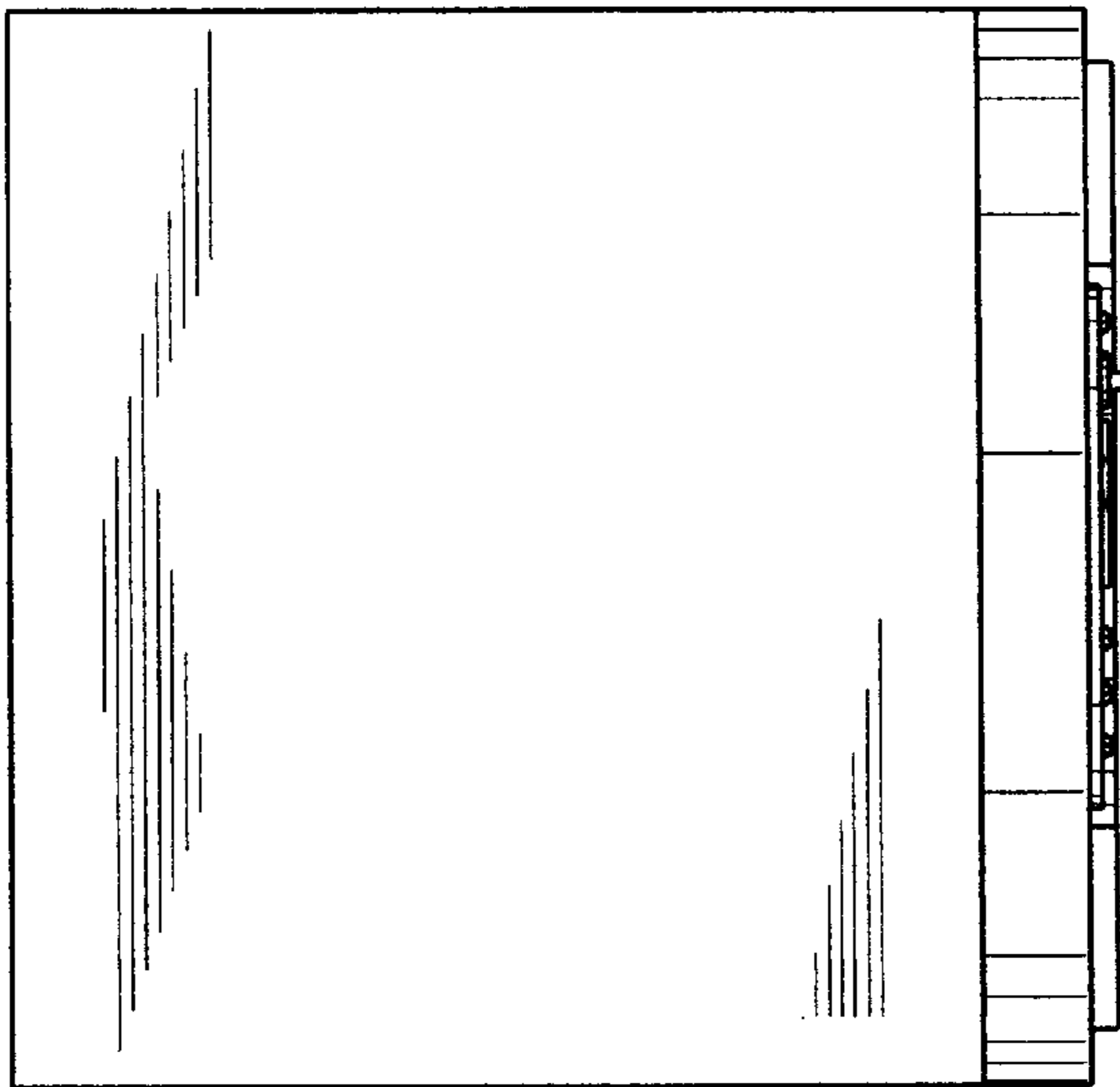

FIG. 4

FIG. 6

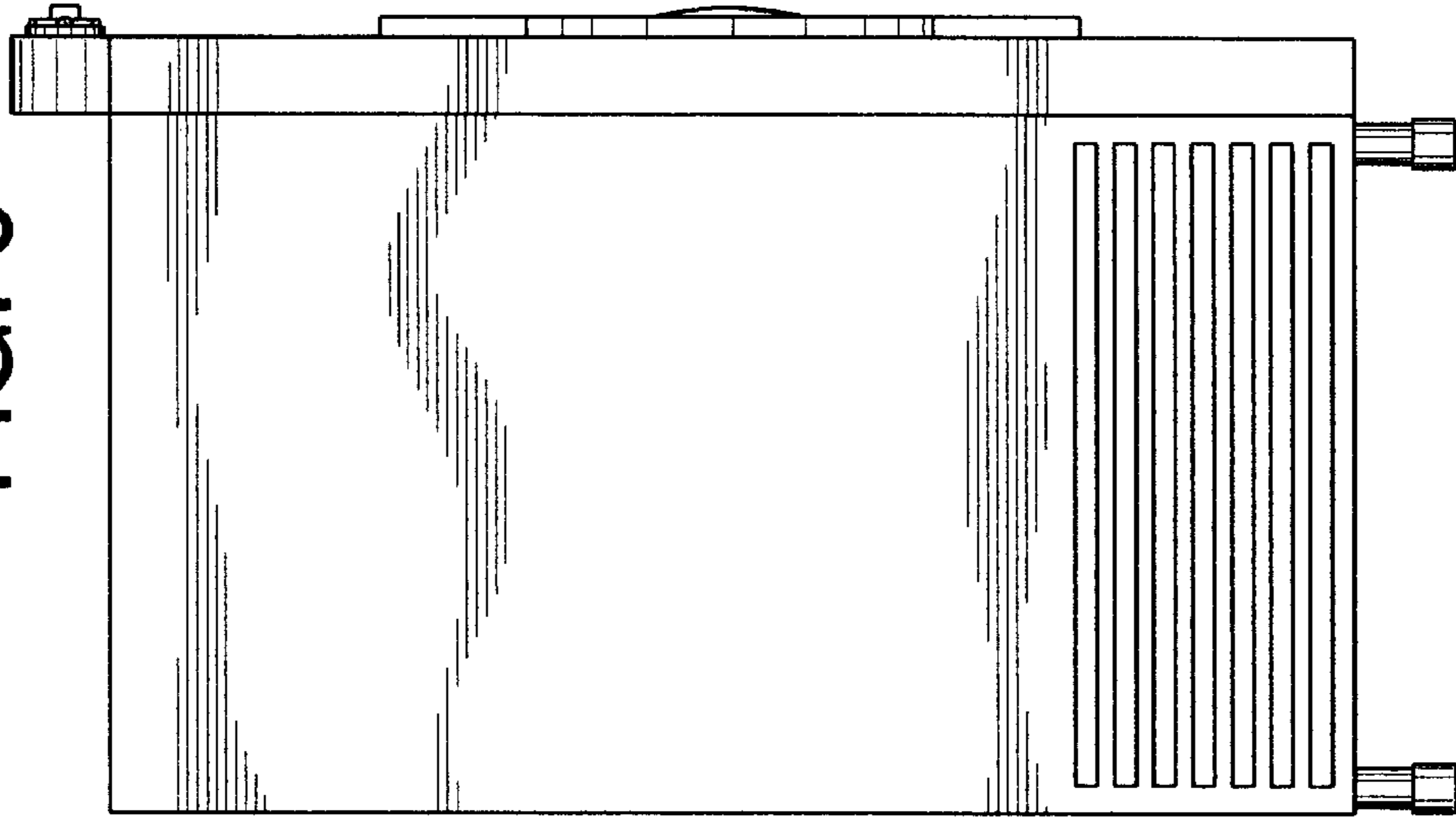
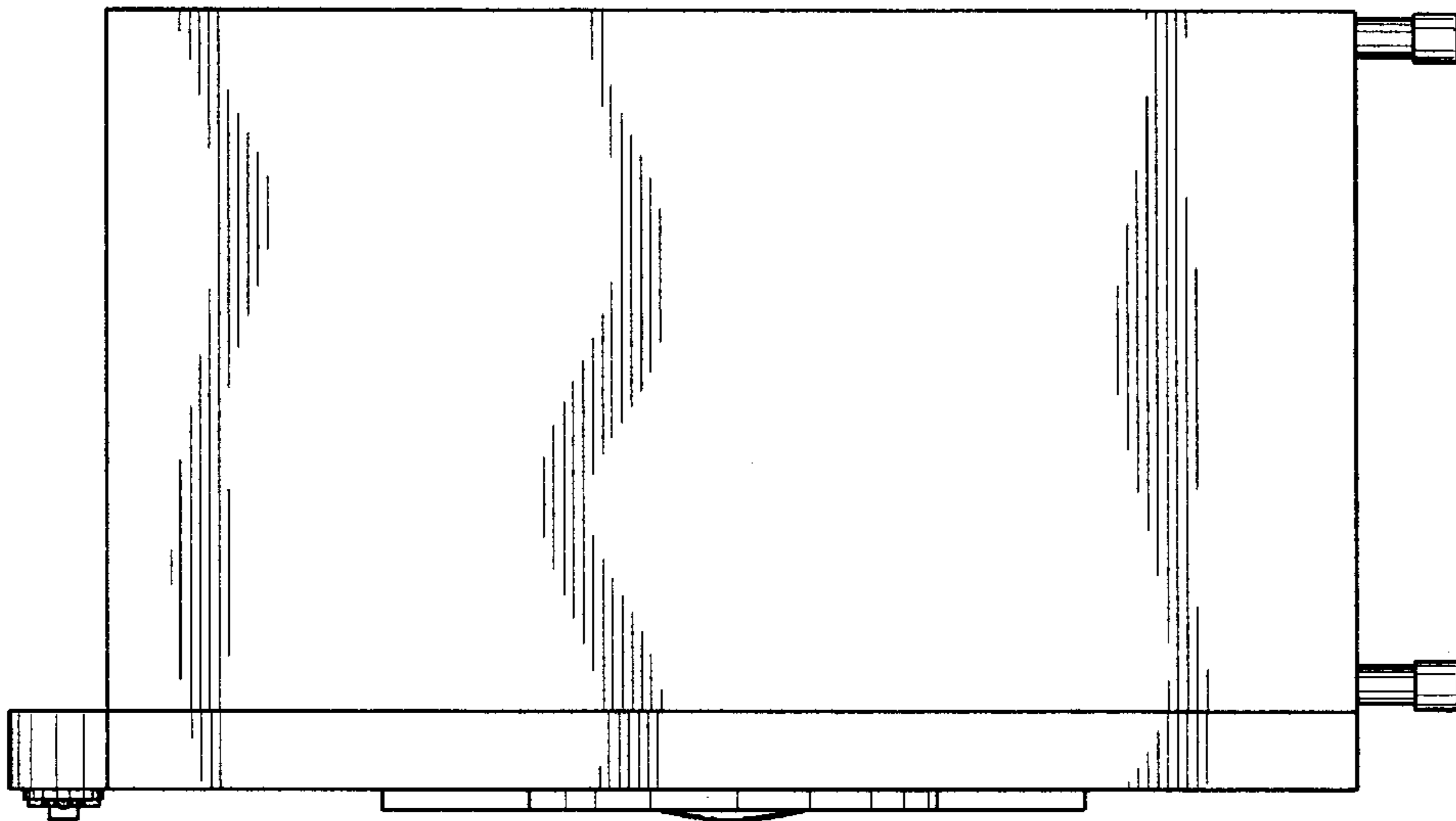

FIG. 5



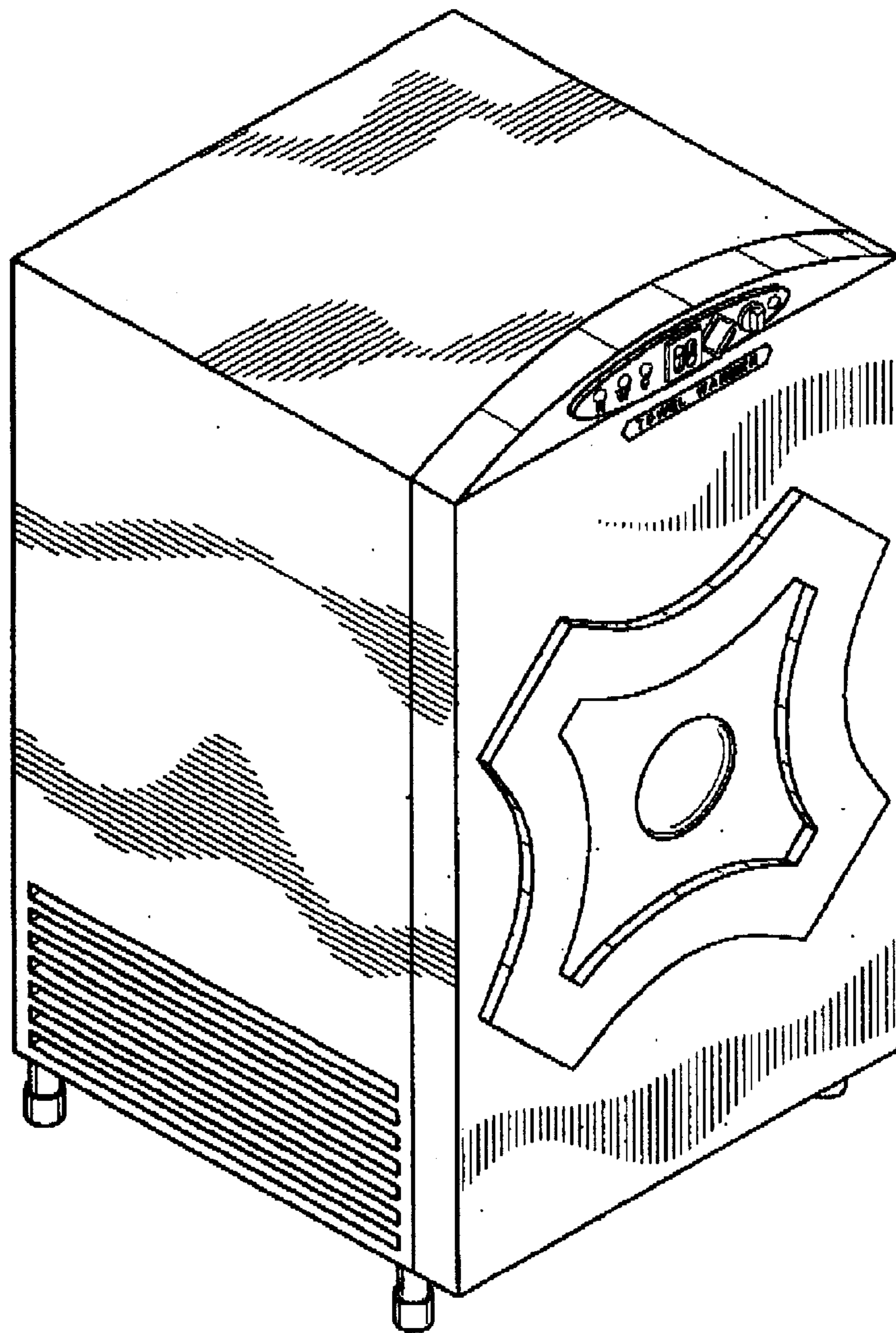

FIG. 7