

US00D542969S

(12) **United States Design Patent**  
**Bixler**

(10) **Patent No.:** **US D542,969 S**

(45) **Date of Patent:** **\*\* May 15, 2007**

(54) **SLOW-RELEASE HUMIDIFIER**

(76) Inventor: **Jon Bixler**, 28351 Sherwood Rd.,  
Willits, CA (US) 95490

(\*\*) Term: **14 Years**

(21) Appl. No.: **29/234,669**

(22) Filed: **Jul. 21, 2005**

(51) **LOC (8) Cl.** ..... **27-06**

(52) **U.S. Cl.** ..... **D27/193**

(58) **Field of Classification Search** ..... D27/186-193;  
312/31, 31.1; 239/56; 206/213.1  
See application file for complete search history.

(56) **References Cited**

**U.S. PATENT DOCUMENTS**

4,638,909	A	*	1/1987	Ford	.....	312/31.1
5,607,051	A	*	3/1997	Espinosa	.....	206/213.1
D386,813	S	*	11/1997	Reno	.....	D27/194
5,803,247	A	*	9/1998	Holmes et al.	.....	206/213.1
D414,891	S	*	10/1999	Schmaling et al.	.....	D27/187
6,068,113	A	*	5/2000	Schmaling et al.	.....	206/213.1

\* cited by examiner

*Primary Examiner*—Jennifer Rivard

(74) *Attorney, Agent, or Firm*—Larson & Larson, PA;  
Herbert W. Larson

(57) **CLAIM**

I claim the ornamental design for a slow-release humidifier,  
as shown and described.

**DESCRIPTION**

FIG. 1 is a front elevational view of the slow release  
humidifier showing my new design.

FIG. 2 is a rear elevational view thereof.

FIG. 3 is a left side elevational view thereof.

FIG. 4 is a right side elevational view thereof.

FIG. 5 is a top elevational view thereof.

FIG. 6 is a bottom elevational view thereof; and,

FIG. 7 is an isometric view thereof, wherein the slow release  
humidifier is shown installed in a cigar humidor with the  
broken line showing of environmental association matter  
being for illustrative purposes only and forming no part of  
the claimed design.

**1 Claim, 4 Drawing Sheets**

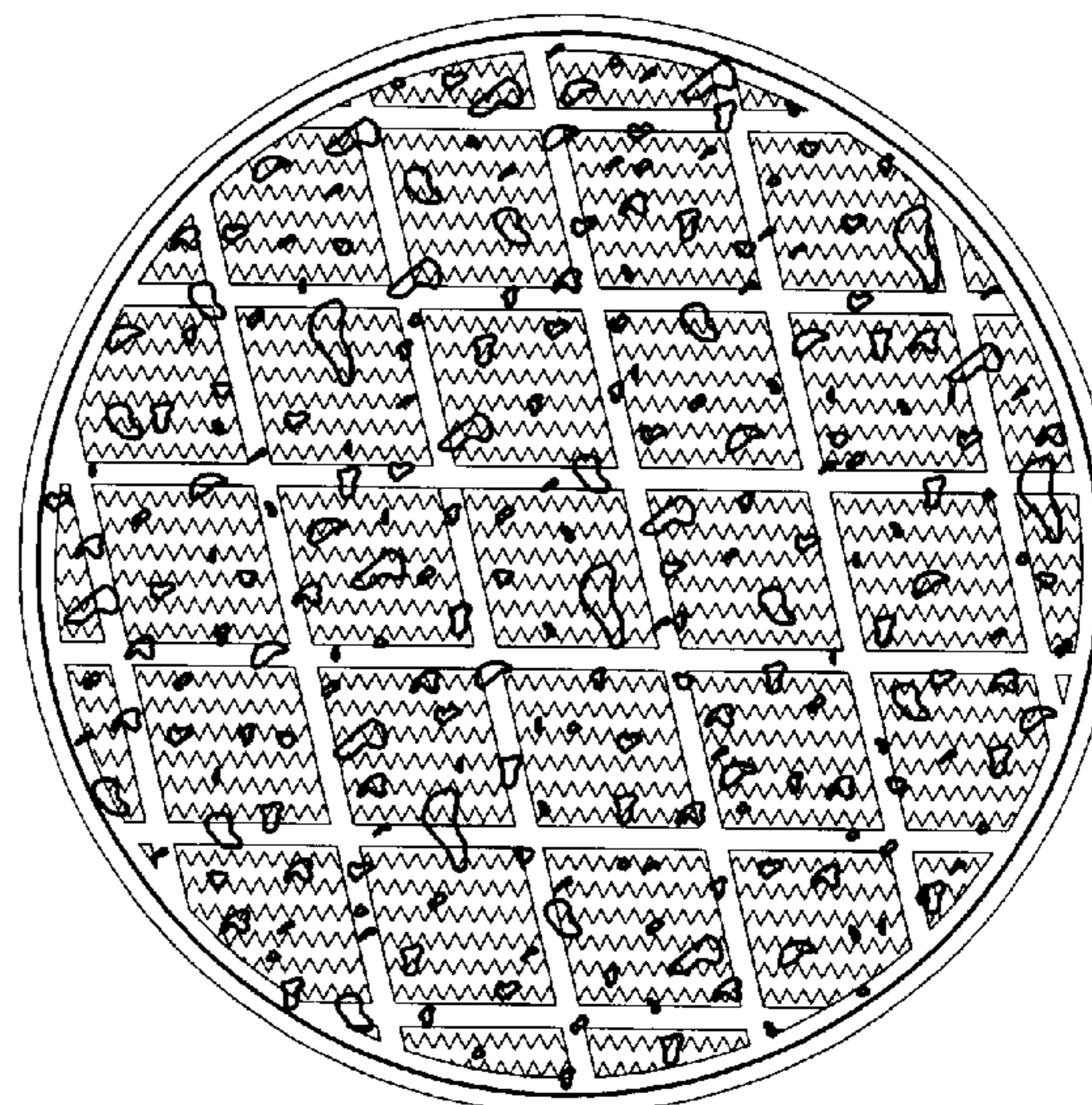
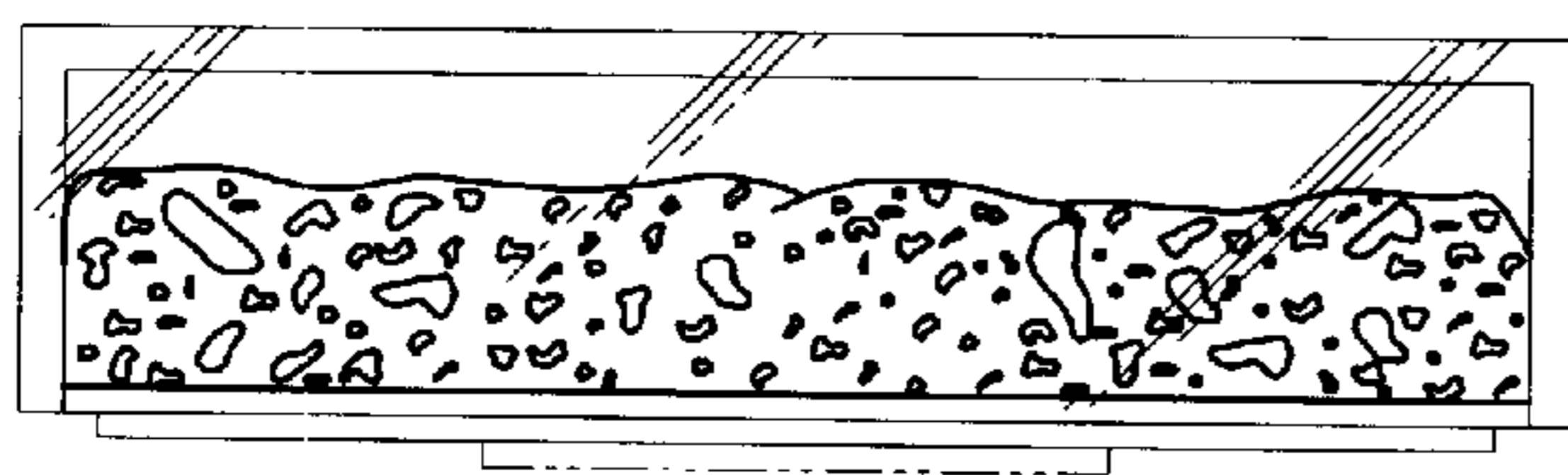

FIG. 1

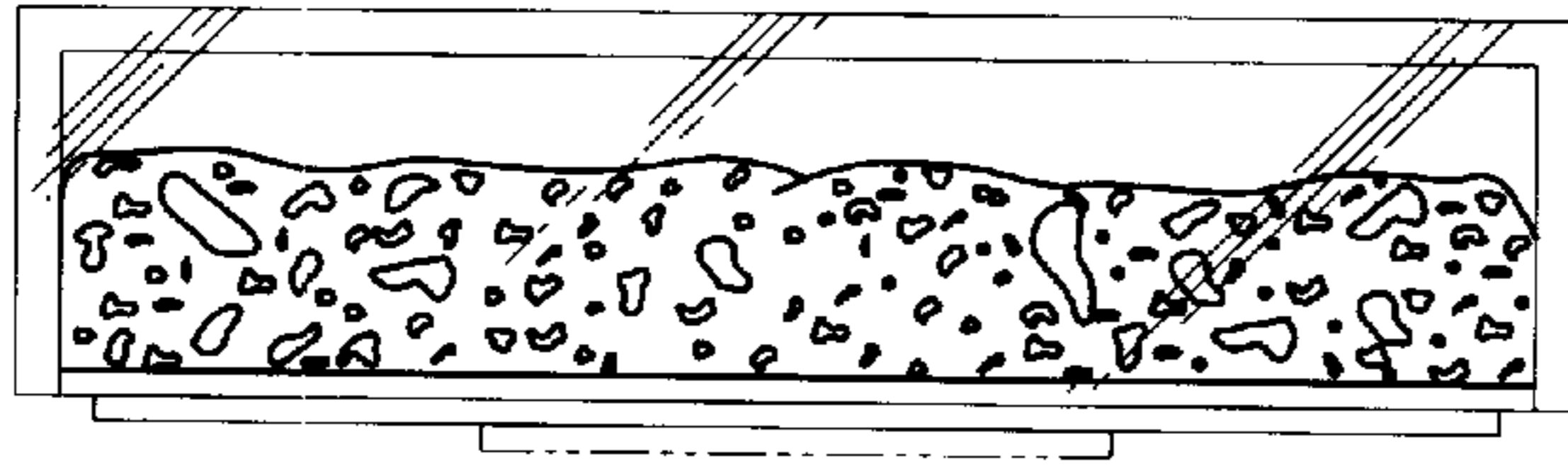

FIG. 2

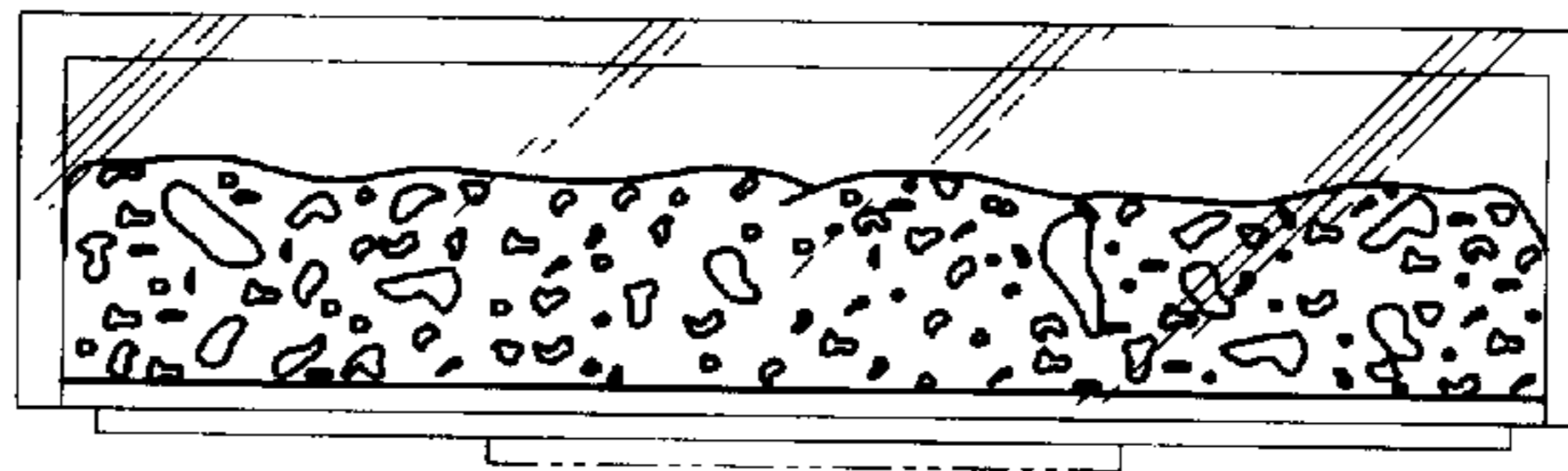

FIG. 3

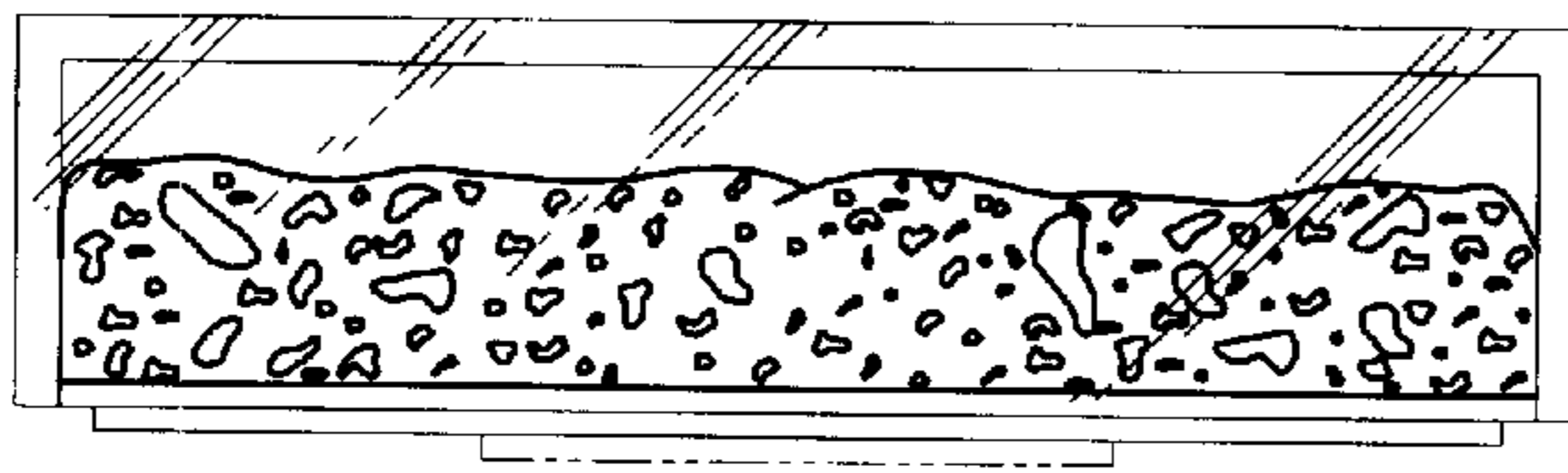

FIG. 4

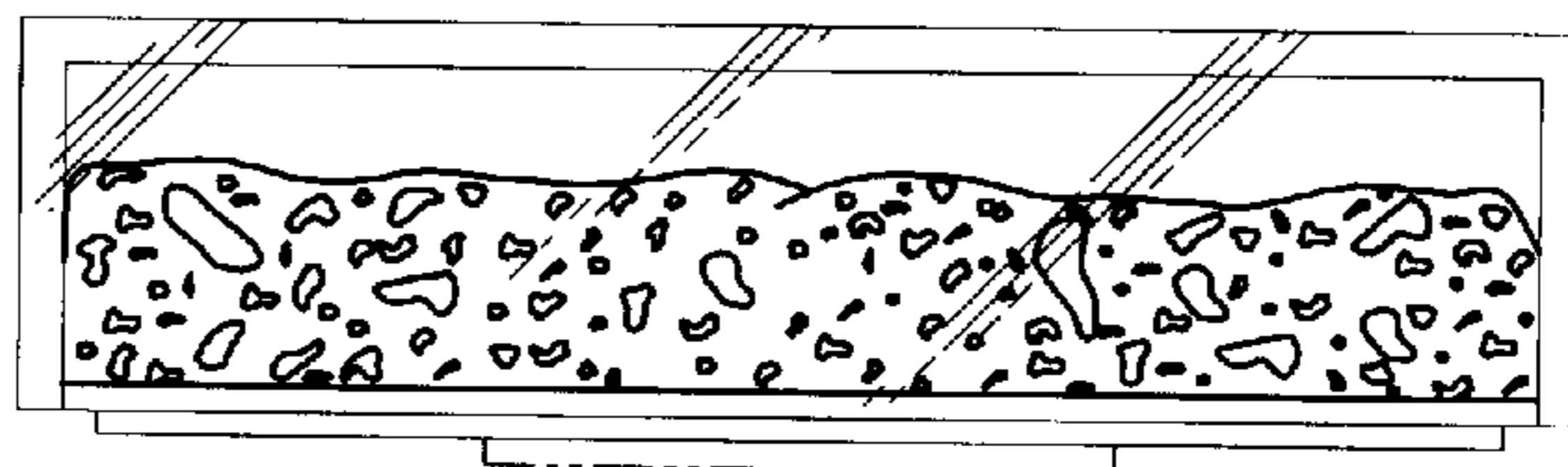

FIG. 5

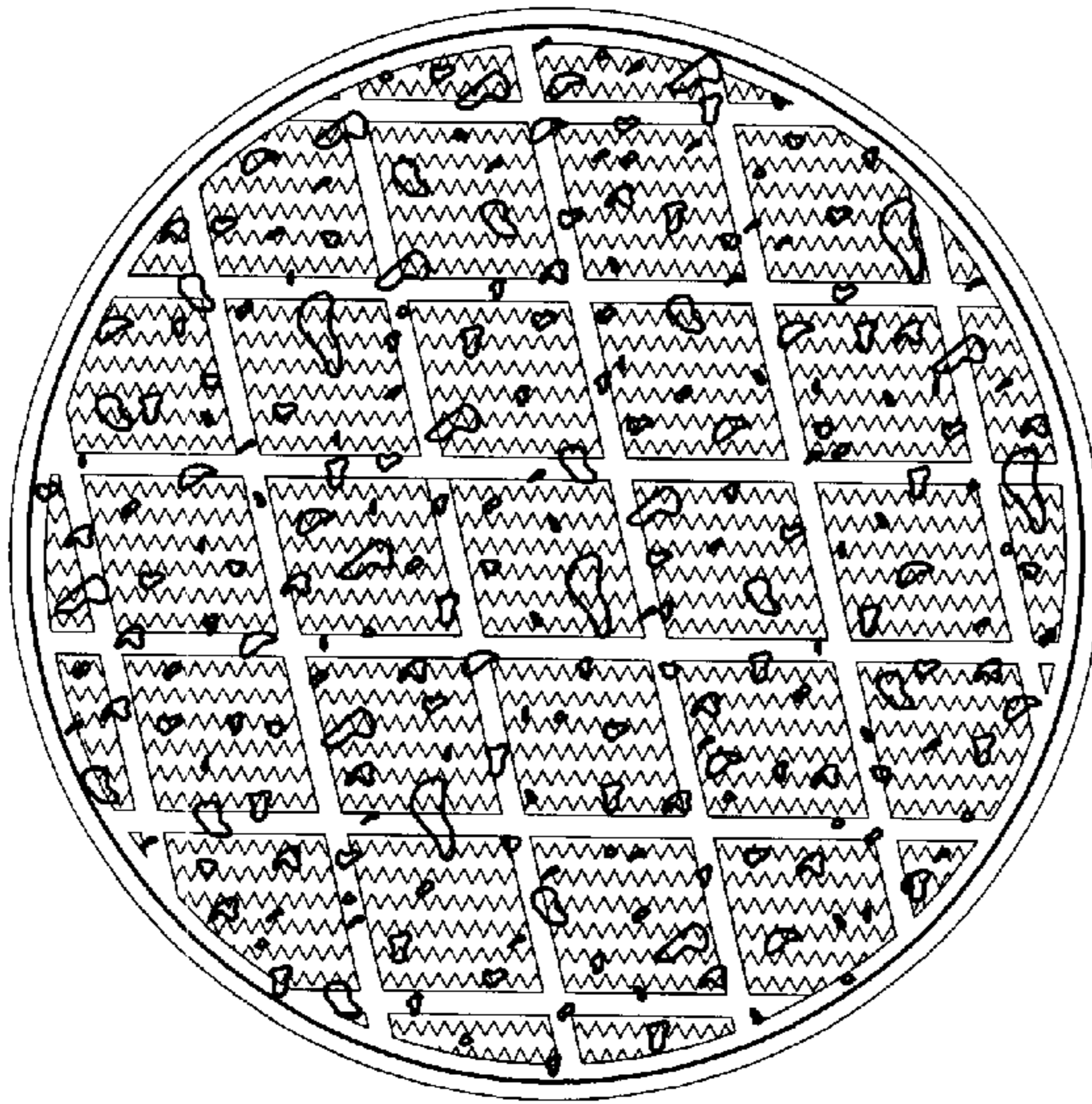
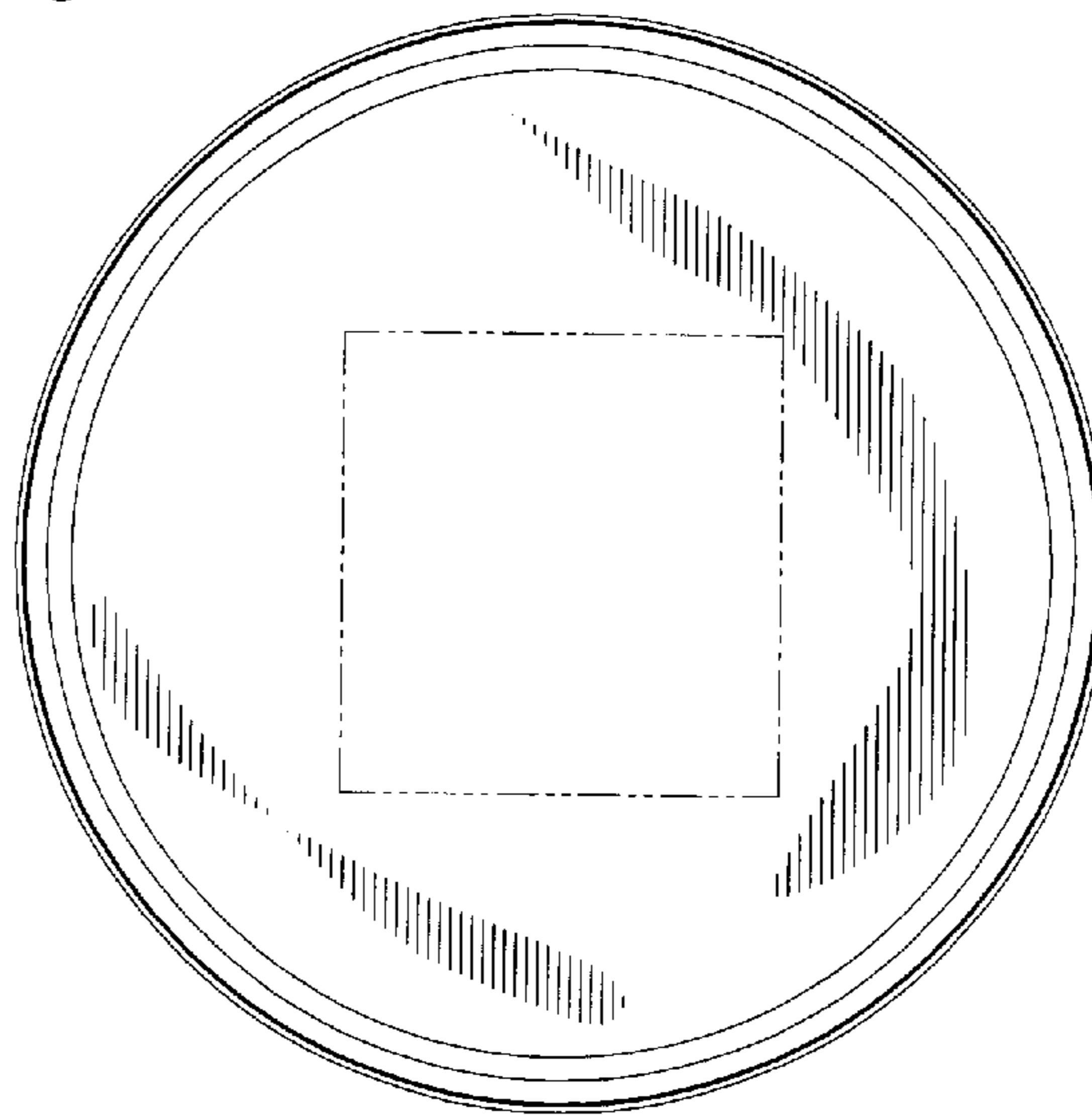

FIG. 6



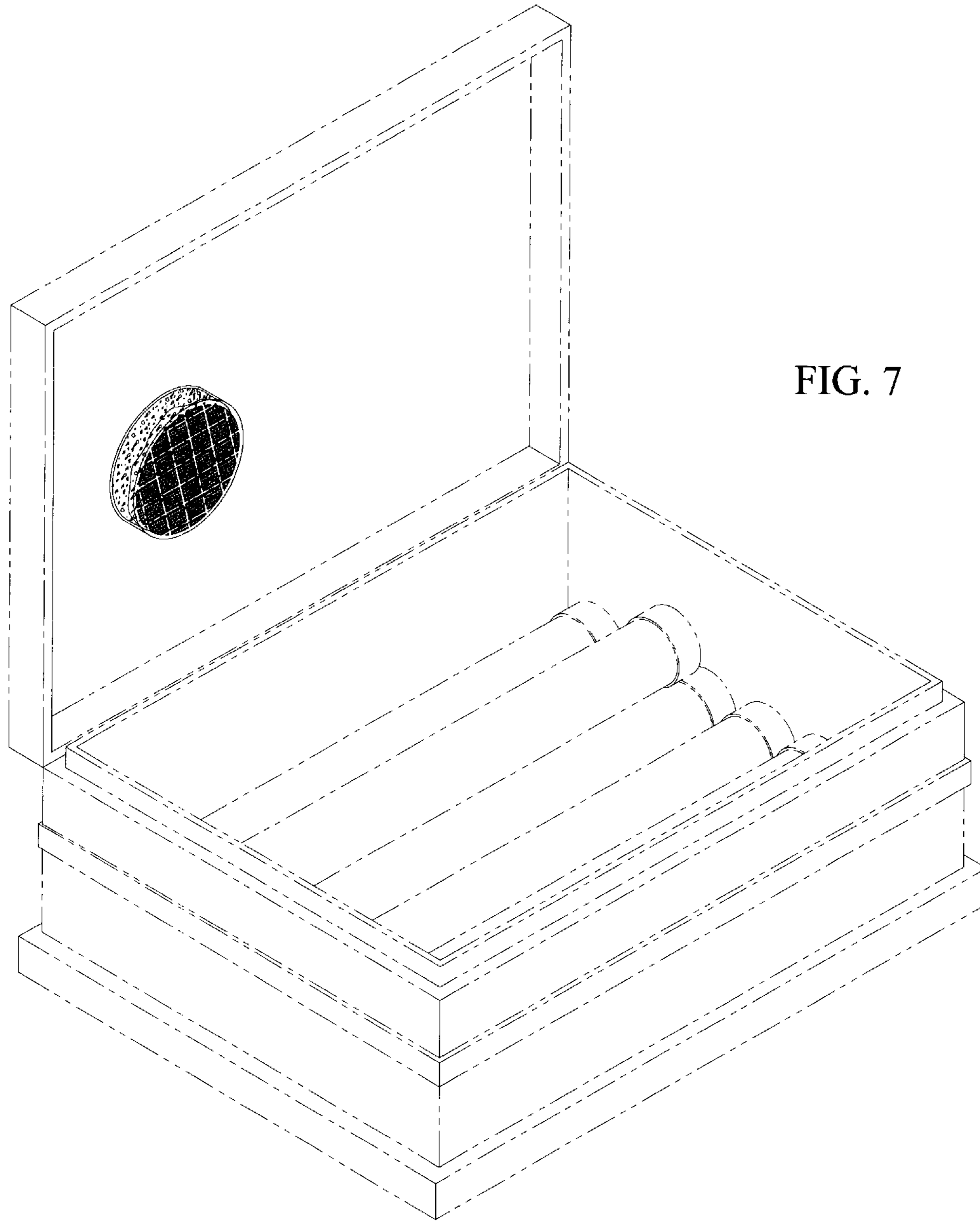

FIG. 7