



US00D542797S

(12) **United States Design Patent** (10) **Patent No.:** **US D542,797 S**  
**Cuellar et al.** (45) **Date of Patent:** **\*\* May 15, 2007**

(54) **MEMORY CARD WITH A CONTACT COVERING LID**

(75) Inventors: **Edwin J. Cuellar**, San Jose, CA (US);  
**Eliyahou Harari**, Saratoga, CA (US);  
**Robert C. Miller**, San Jose, CA (US);  
**Hem P. Takiar**, Fremont, CA (US);  
**Robert F. Wallace**, Sunnyvale, CA (US)

(73) Assignee: **SanDisk Corporation**, Milpitas, CA (US)

(\*\*) Term: **14 Years**

(21) Appl. No.: **29/235,538**

(22) Filed: **Aug. 2, 2005**

(51) **LOC (8) Cl.** ..... **14-02**

(52) **U.S. Cl.** ..... **D14/436**

(58) **Field of Classification Search** ..... 235/441,  
235/443, 487, 492, 493, 495; D14/435-38,  
D14/478-80; 361/737, 679, 736, 728, 729-30;  
257/678-79; 439/946; 174/250, 260, 52.1-52.2  
See application file for complete search history.

(56) **References Cited**

**U.S. PATENT DOCUMENTS**

D445,111 S	7/2001	Okamoto et al.	
D446,525 S	8/2001	Okamoto et al.	
D452,690 S	1/2002	Wallace et al.	
D452,865 S	1/2002	Wallace et al.	
D453,934 S	2/2002	Wallace et al.	
D457,887 S	5/2002	Kadonaga	
D488,475 S	4/2004	Yu et al.	
D488,476 S	4/2004	Yu et al.	
D488,477 S	4/2004	Yu et al.	
D491,951 S	6/2004	Yu et al.	
D492,314 S	6/2004	Huang et al.	
D492,686 S	7/2004	Yu et al.	
D493,466 S	7/2004	Yu et al.	
D493,798 S	8/2004	Yu et al.	
D494,180 S	8/2004	Taniguchi	
D498,760 S	11/2004	Chiang et al.	
6,865,086 B2 *	3/2005	Gochnour et al. ....	361/737

6,890,188 B1	5/2005	Le
D505,959 S	6/2005	Yamada et al.
6,908,038 B1	6/2005	Le
2003/0100203 A1	5/2003	Yen
2004/0037145 A1	2/2004	Tagawa et al.
2004/0062109 A1	4/2004	Wallace

**FOREIGN PATENT DOCUMENTS**

DE 203 04 040 U1 8/2003

**OTHER PUBLICATIONS**

“PQI—Our Products”, <http://www.pqi.com.tw/eng/ourproduct/ourproduct.htm>, Feb. 20, 2004, 3 pages.

\* cited by examiner

*Primary Examiner*—M. H. Tung

*Assistant Examiner*—Susan Moon Lee

(74) *Attorney, Agent, or Firm*—Parsons Hsue & de Runtz LLP

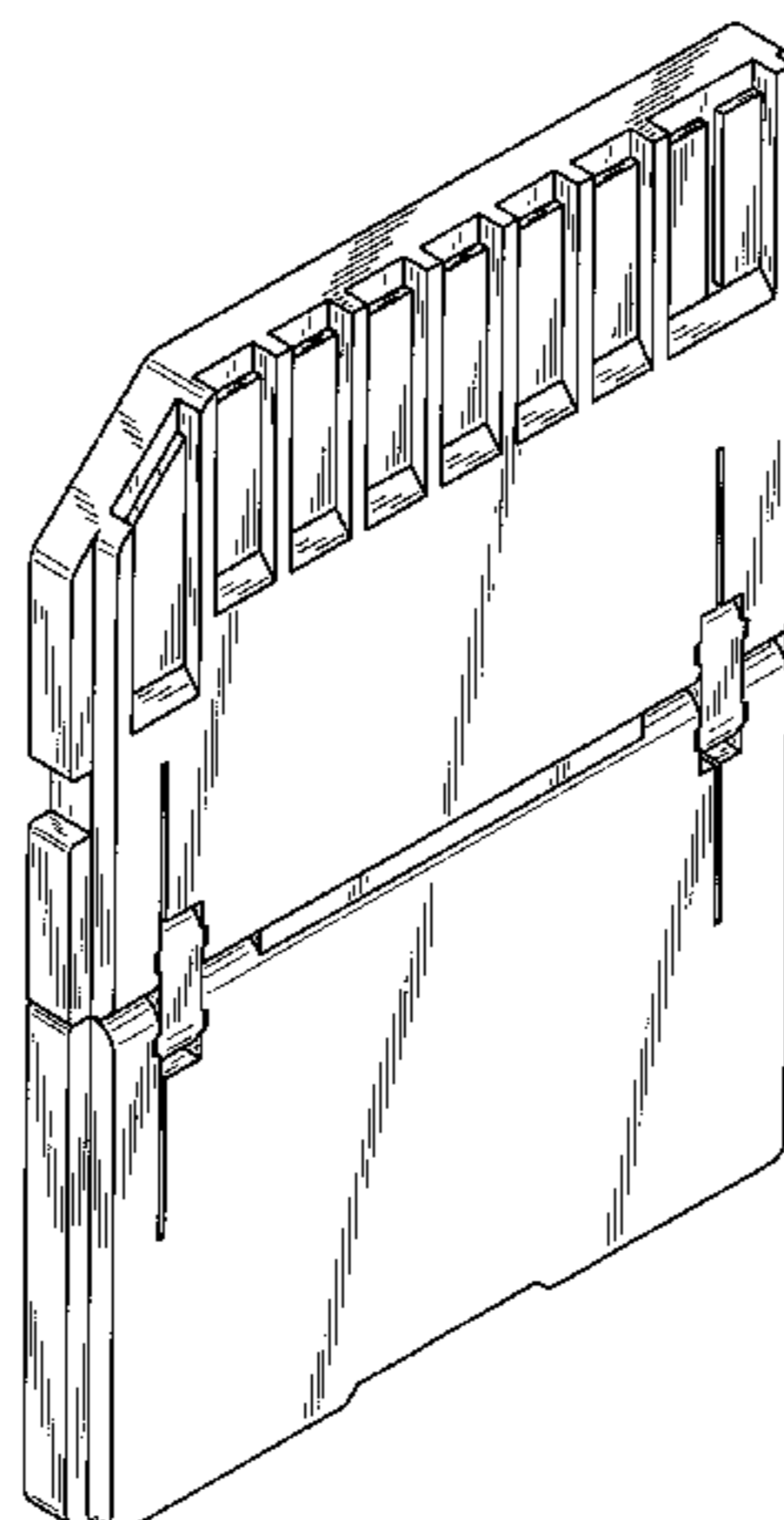
(57) **CLAIM**

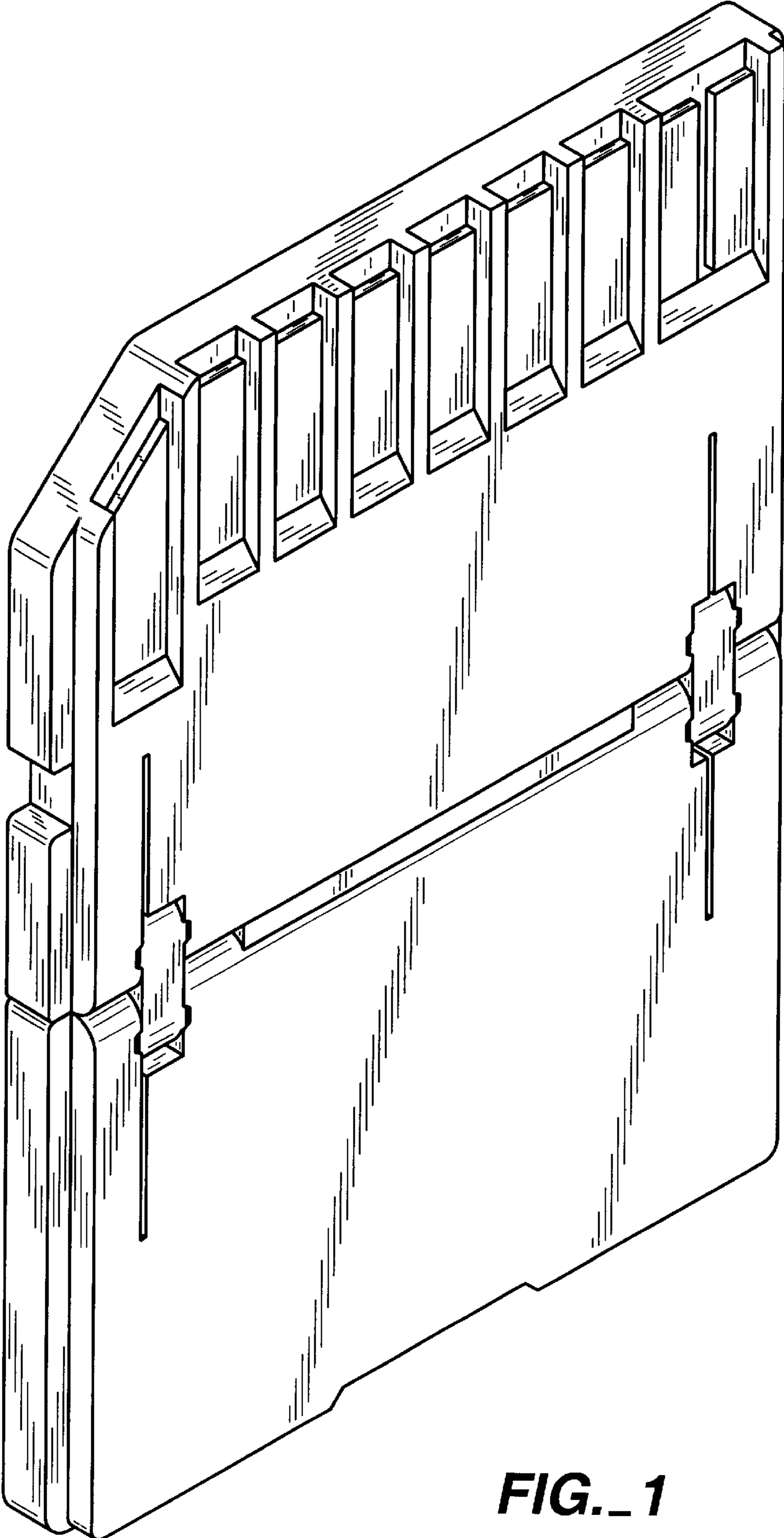
We claim the ornamental design for a memory card with a contact covering lid, as shown and described.

**DESCRIPTION**

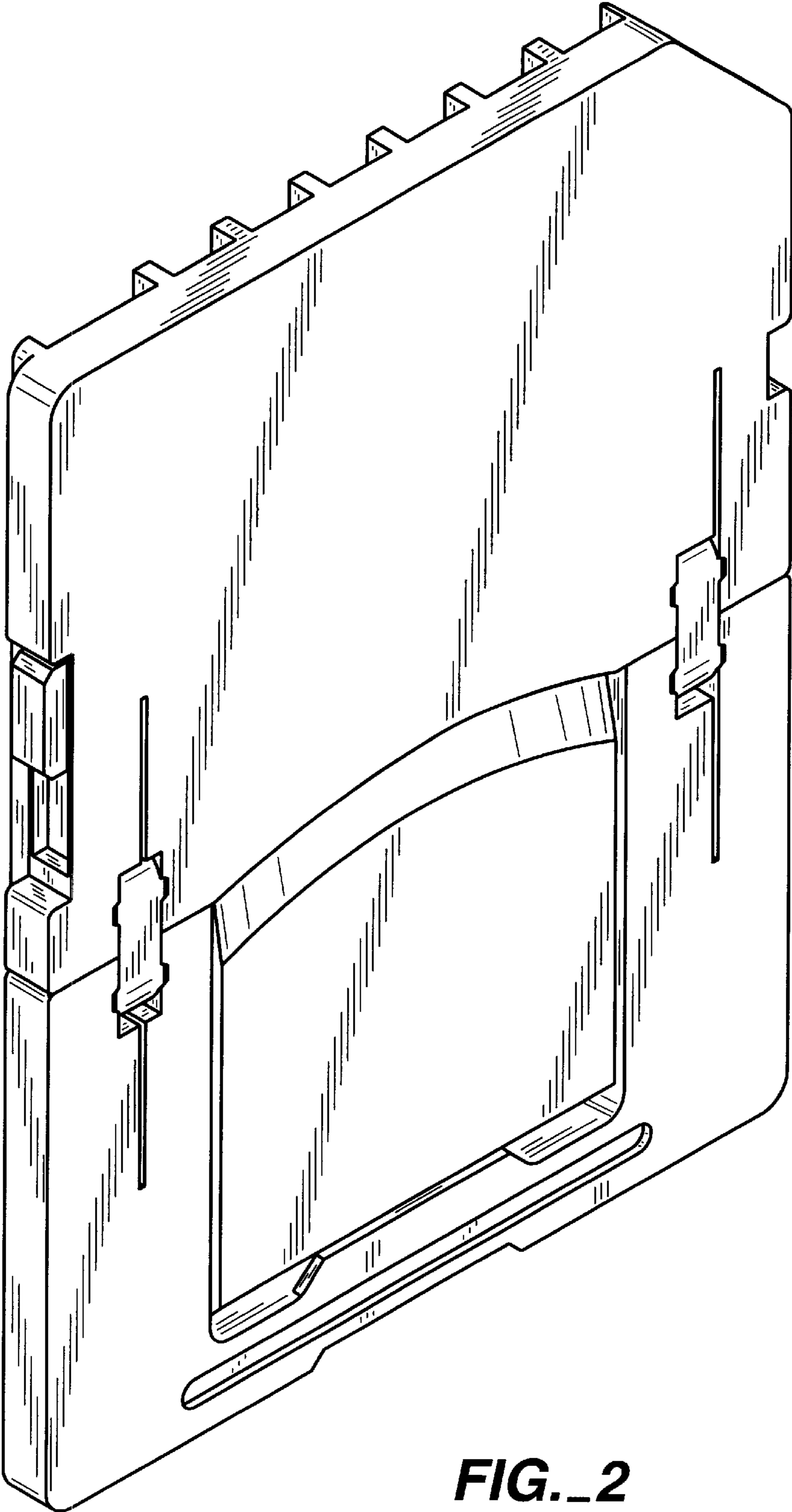
FIG. 1 is a front, top, left side isometric view of the memory card with its lid closed;  
FIG. 2 is a rear, top, right side isometric view thereof;  
FIG. 3 is a front elevational view thereof;  
FIG. 4 is a right side elevational view thereof;  
FIG. 5 is a rear elevational view thereof;  
FIG. 6 is a left side elevational view thereof;  
FIG. 7 is a top elevational view thereof;  
FIG. 8 is a bottom elevational view thereof.  
FIG. 9 is a front, top, left side isometric view of the memory card with its lid opened;  
FIG. 10 is a rear, top, right side isometric view thereof;  
FIG. 11 is a front elevational view thereof;  
FIG. 12 is a right side elevational view thereof;  
FIG. 13 is a rear elevational view thereof;  
FIG. 14 is a left side elevational view thereof;  
FIG. 15 is a top elevational view thereof; and,  
FIG. 16 is a bottom elevational view thereof.

**1 Claim, 9 Drawing Sheets**

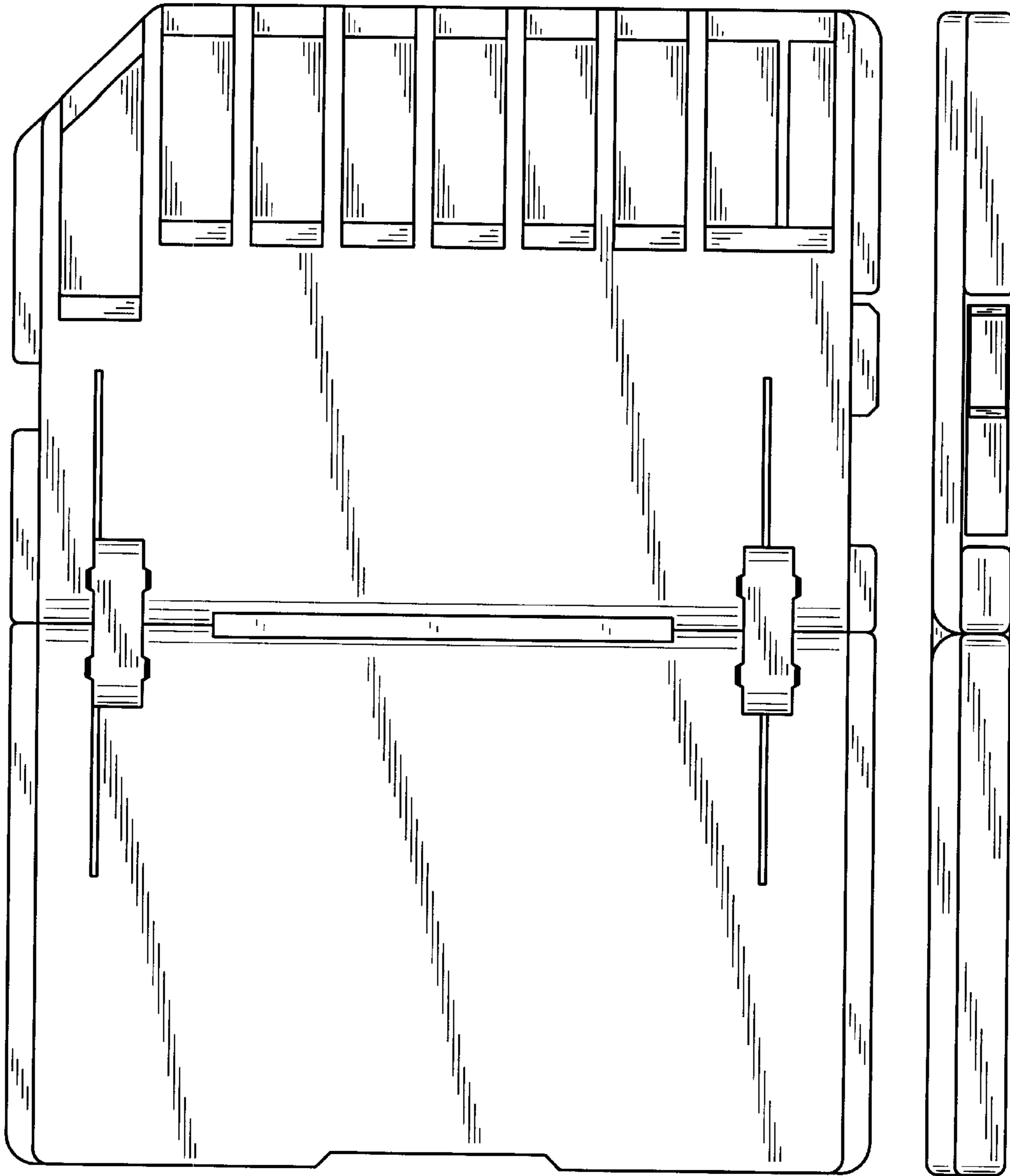




**FIG. 1**



**FIG. 2**

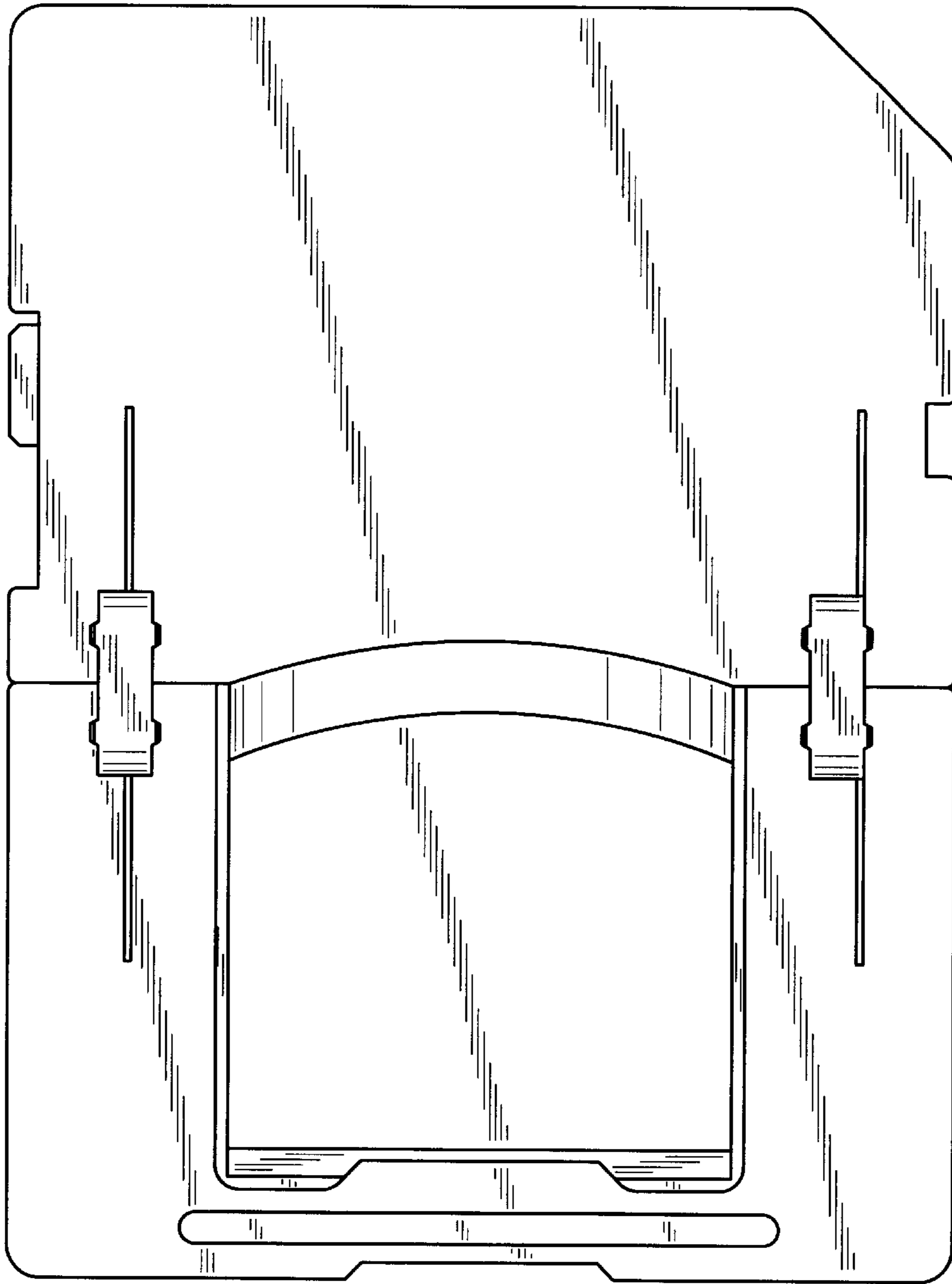


**FIG.\_3**

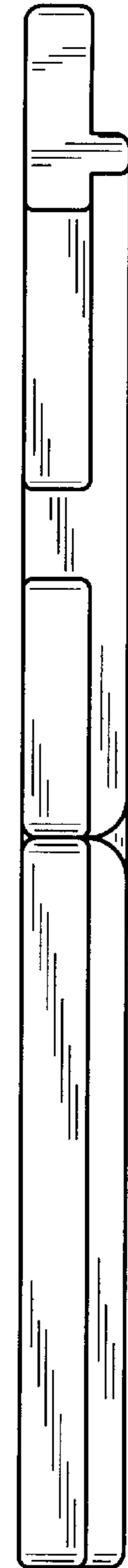
**FIG.\_4**



**FIG.\_7**



**FIG.\_5**

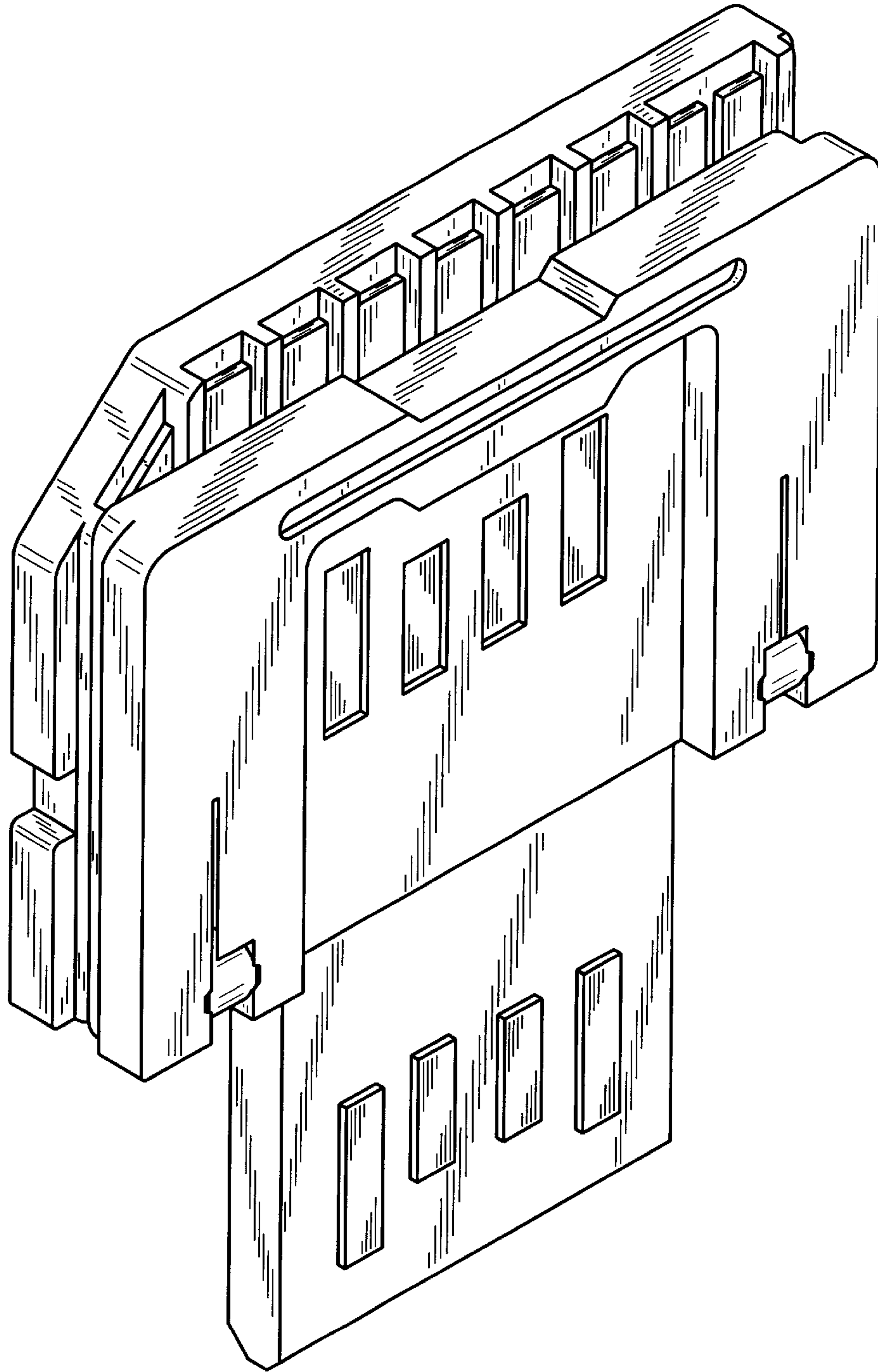


**FIG.\_6**

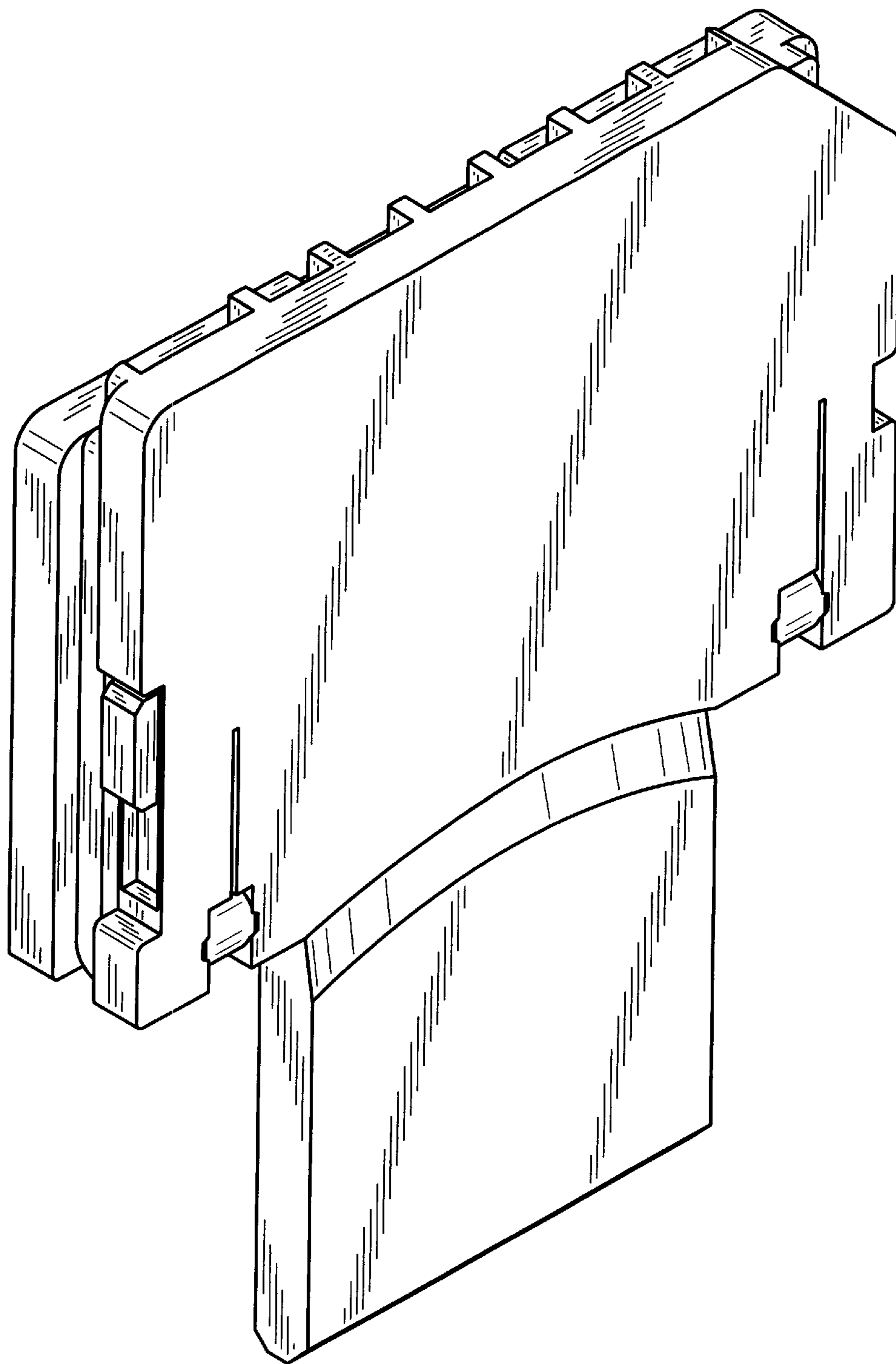


**FIG.\_8**

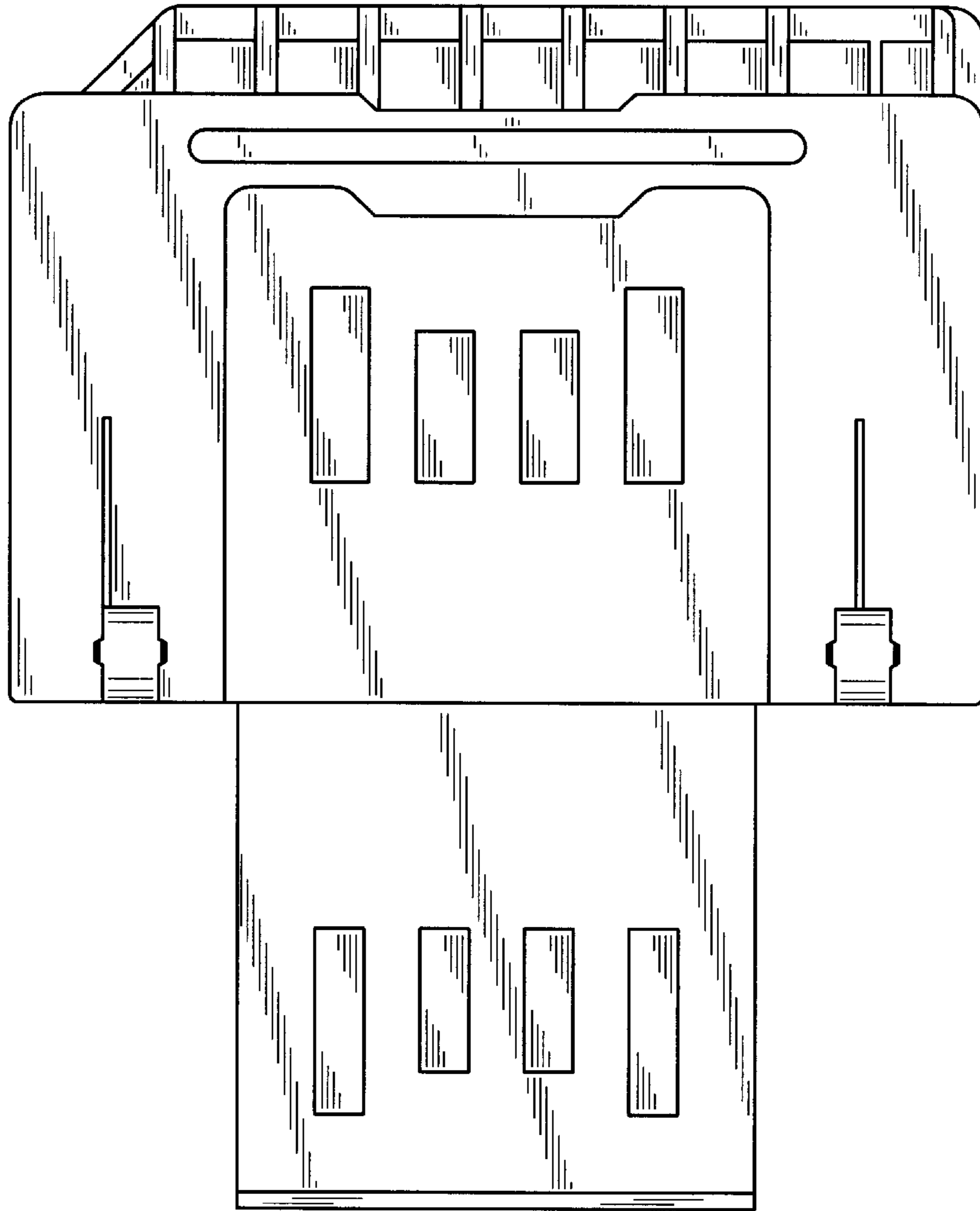




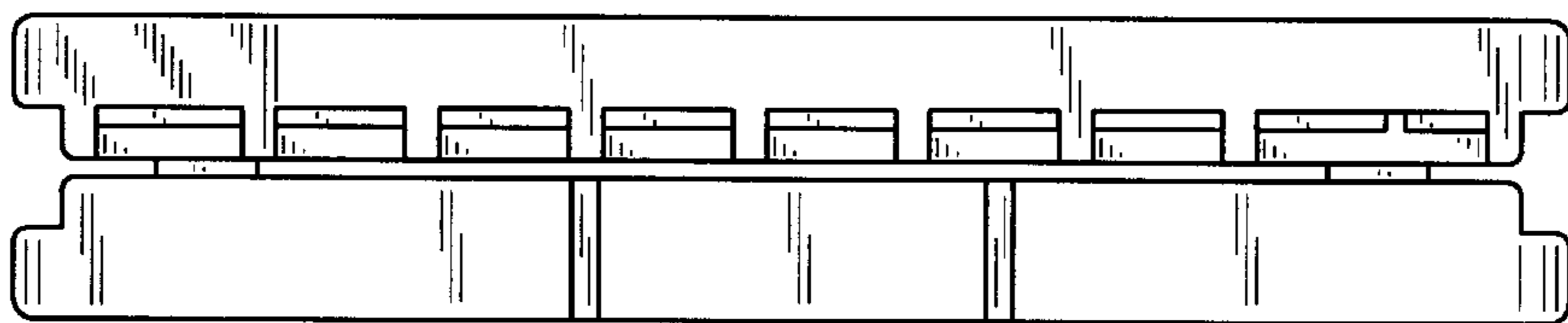
**FIG. 9**



**FIG. 10**

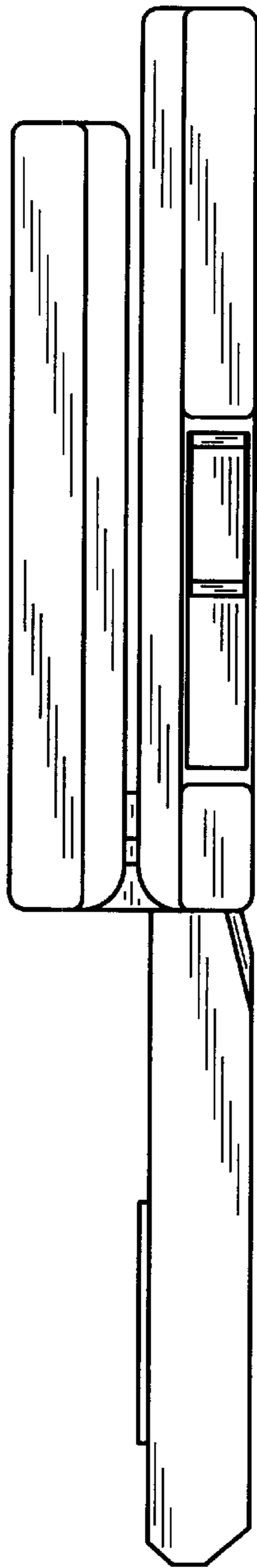


**FIG. 11**

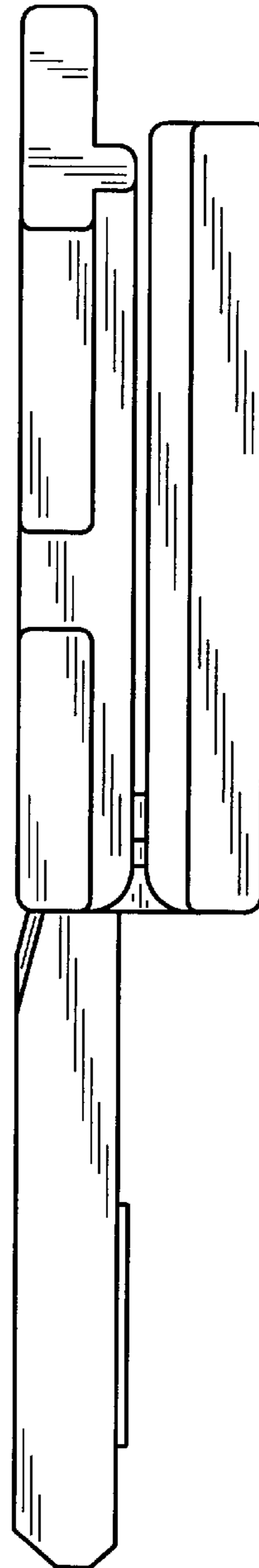


**FIG. 15**

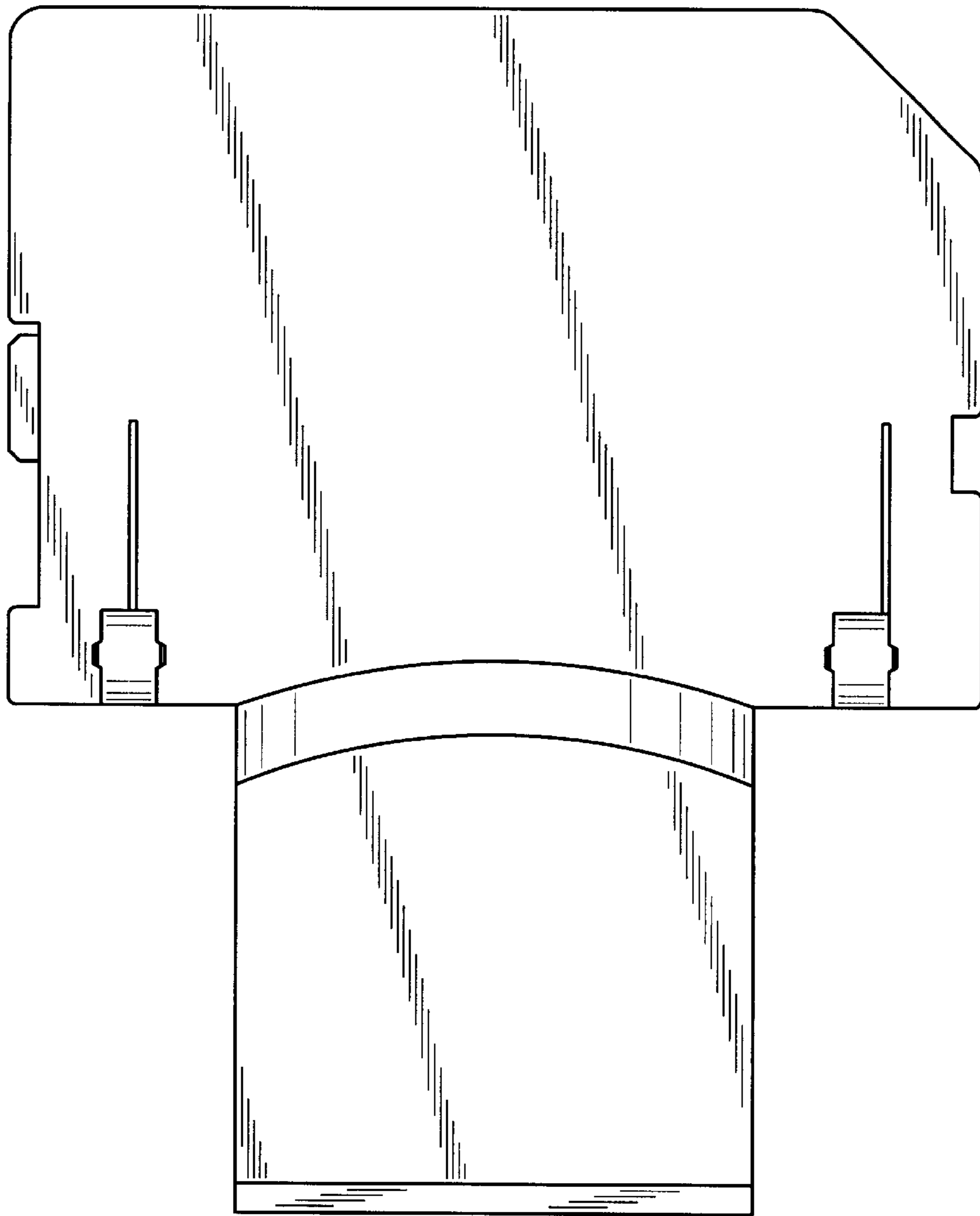




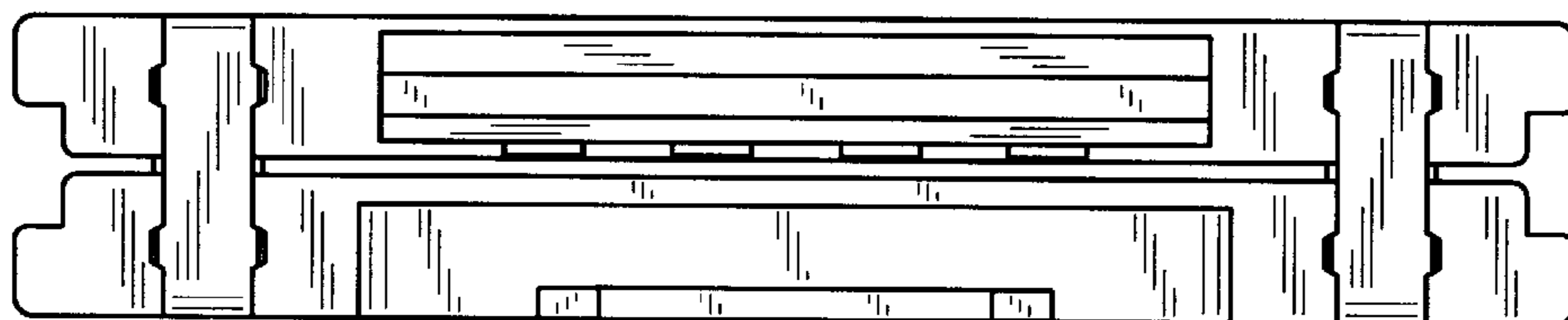
**FIG. 12**



**FIG. 14**



**FIG. 13**



**FIG. 16**