

US00D542783S

(12) **United States Design Patent**  
**Cislo**

(10) **Patent No.:** **US D542,783 S**

(45) **Date of Patent:** **\*\* May 15, 2007**

(54) **LOW VISIBILITY AERODYNAMIC ANTENNA HOUSING**

(75) Inventor: **Donald M. Cislo**, Glendale Heights, IL (US)

(73) Assignee: **Antenex, Inc.**, Schaumburg, IL (US)

(\*\*) Term: **14 Years**

(21) Appl. No.: **29/234,763**

(22) Filed: **Jul. 22, 2005**

(51) **LOC (8) Cl.** ..... **14-03**

(52) **U.S. Cl.** ..... **D14/230**

(58) **Field of Classification Search** ..... D14/137, D14/138, 230-238, 299, 358; D12/42, 43; 343/700 R-705, 871-908, 795, 840, 711-713, 343/819, 846; 455/90.2, 90.3, 91, 128, 269, 455/344, 347, 562.1

See application file for complete search history.

(56) **References Cited**

**U.S. PATENT DOCUMENTS**

D157,090 S	1/1950	Schmidt	.....	D26/14
2,505,424 A	*	4/1950	Moseley	..... 343/776
D225,221 S	*	11/1972	Sikorski et al.	..... D10/109
D287,588 S	*	1/1987	Ulch	..... D14/231
D293,575 S	*	1/1988	Sugiura	..... D14/230
D356,314 S		3/1995	Rich et al.	..... D14/236
D357,683 S		4/1995	Cline et al.	..... D14/230
D361,569 S	*	8/1995	Jervis	..... D14/230
D418,840 S		1/2000	Cota et al.	..... D14/230
6,023,245 A		2/2000	Gomez et al.	..... 343/725
D429,720 S		8/2000	Strand	..... D14/230
D443,263 S		6/2001	Strand et al.	..... D14/230
D461,796 S		8/2002	Boyer	..... D14/230
D465,480 S		11/2002	Boyer	..... D14/230

D470,131 S	2/2003	Noro et al.	.....	D14/230
D470,481 S	2/2003	Ikeda	.....	D14/230
D472,892 S	4/2003	Tourres	.....	D14/230
D480,712 S	10/2003	Noro	.....	D14/230
D481,028 S	10/2003	Wu	.....	D14/230
D482,350 S	11/2003	Noro et al.	.....	D14/230
D489,712 S	5/2004	Nagatomi	.....	D14/230
D491,926 S	6/2004	Tai et al.	.....	D14/230
D493,447 S	7/2004	Noro et al.	.....	D14/230
6,762,727 B2	7/2004	Rochford et al.	.....	343/713
D501,201 S	*	1/2005	Chiang et al.	..... D14/230
2004/0183734 A1	9/2004	Noro et al.	.....	343/713

\* cited by examiner

*Primary Examiner*—Louis S. Zarfes

*Assistant Examiner*—John Windmuller

(74) *Attorney, Agent, or Firm*—Cislo & Thomas LLP

(57) **CLAIM**

I claim the ornamental design for a low visibility aerodynamic antenna housing, as shown and described herein.

**DESCRIPTION**

This patent application is related to U.S. patent application Ser. No. 29/232,876 filed Jun. 25, 2004 for Low Visibility Aerodynamic Antenna Housing, which application is incorporated herein by this reference thereto.

FIG. 1 is a front perspective view of a low visibility aerodynamic antenna housing showing my new design;

FIG. 2 is a top plan view thereof;

FIG. 3 is a right side elevational view thereof;

FIG. 4 is a left side elevational view thereof;

FIG. 5 is a front elevational view thereof; and,

FIG. 6 is a rear elevational view thereof.

The broken line portions of the disclosure are for illustrative purposes only and form no part of the claimed design.

**1 Claim, 3 Drawing Sheets**

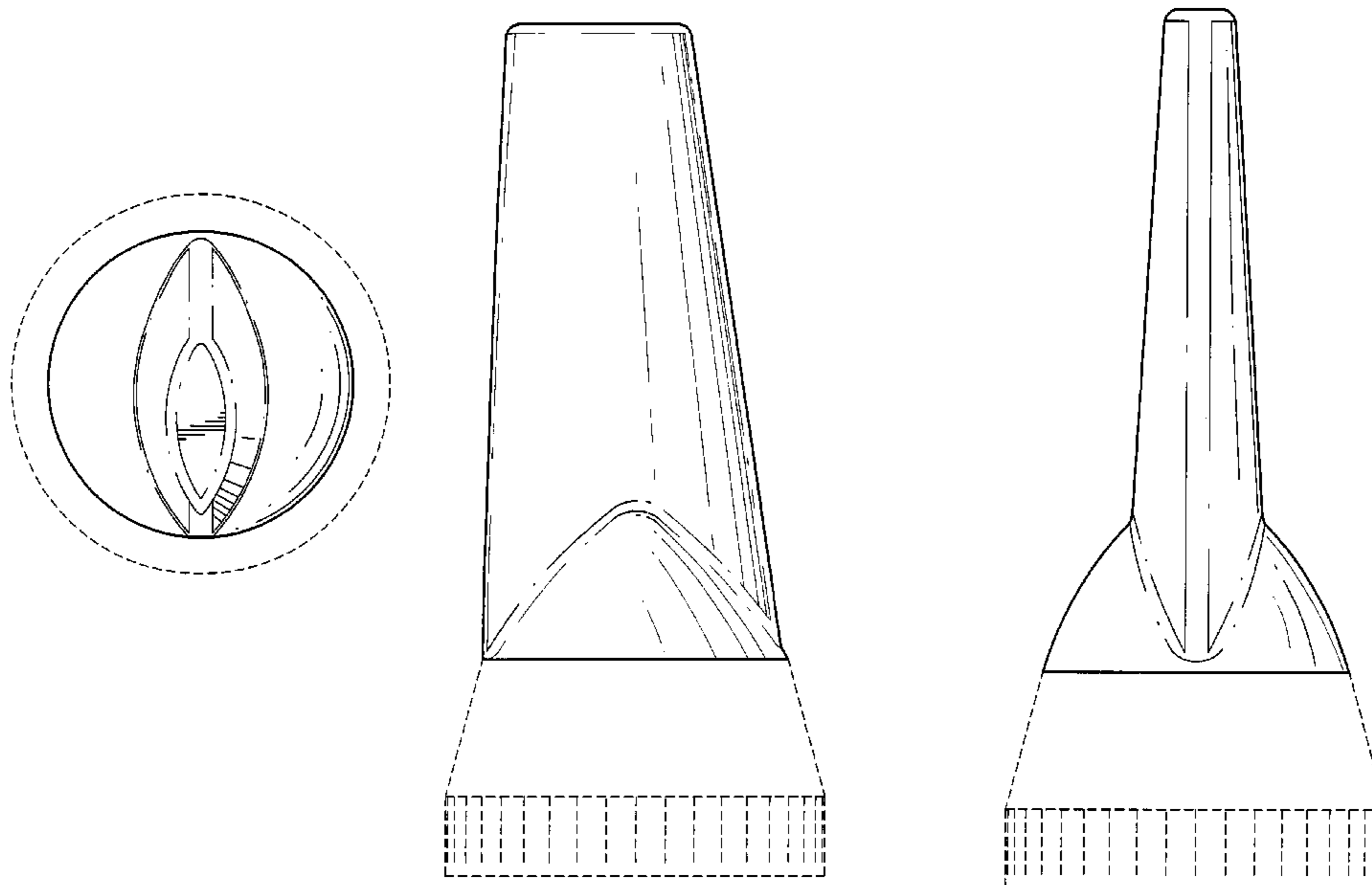

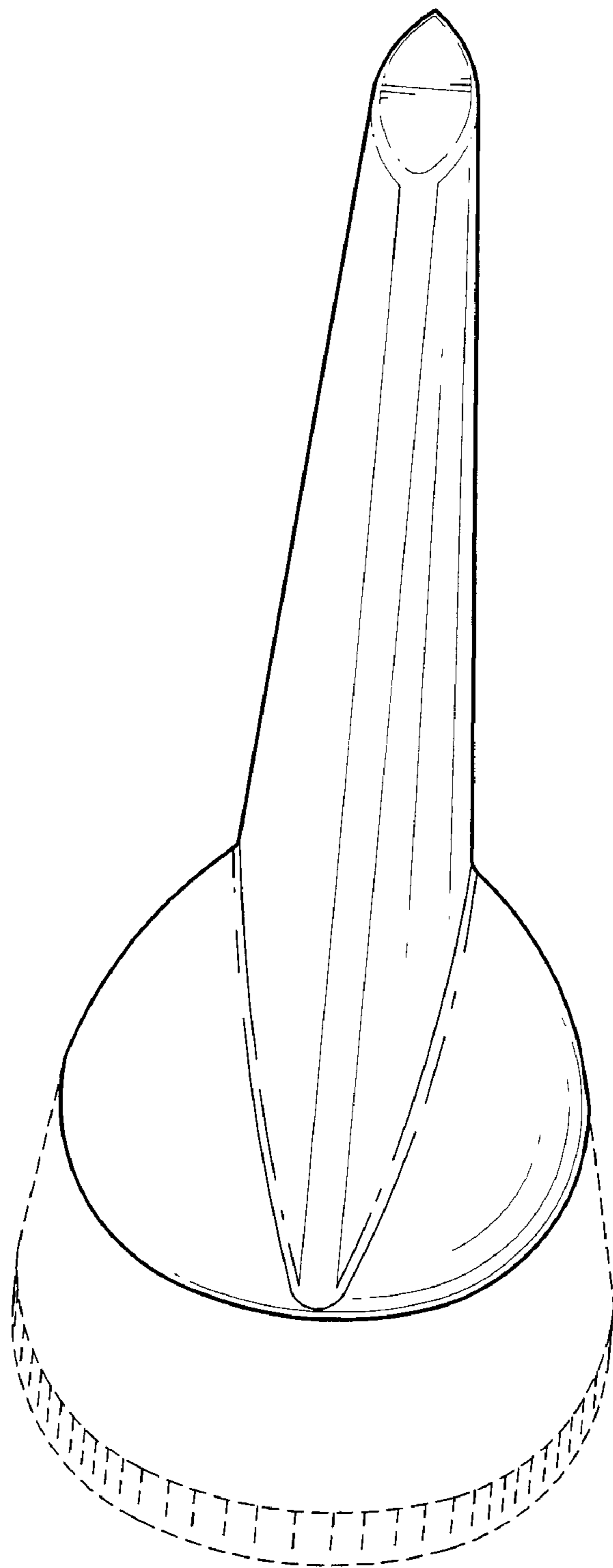

FIG. 1

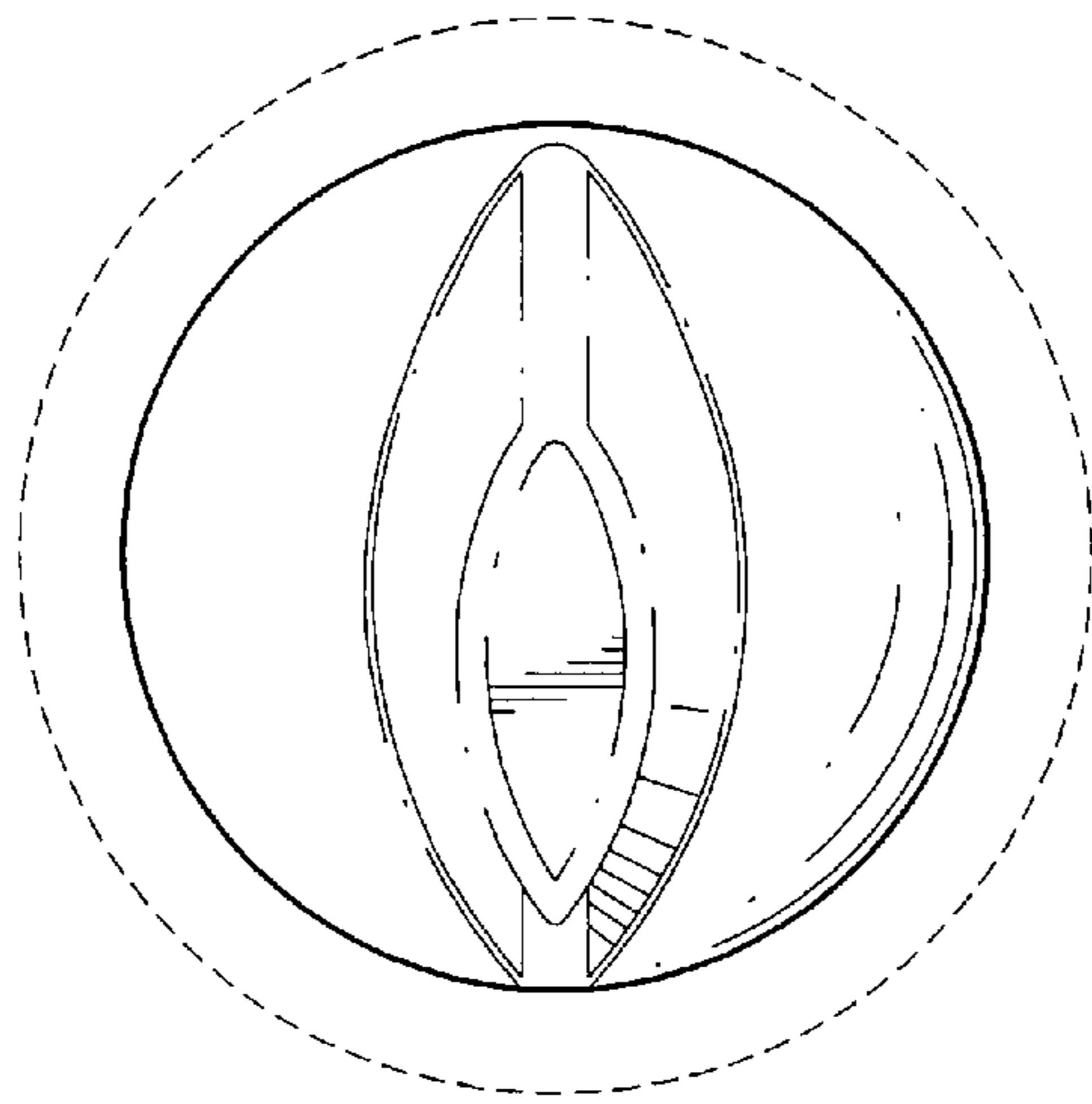

FIG. 2

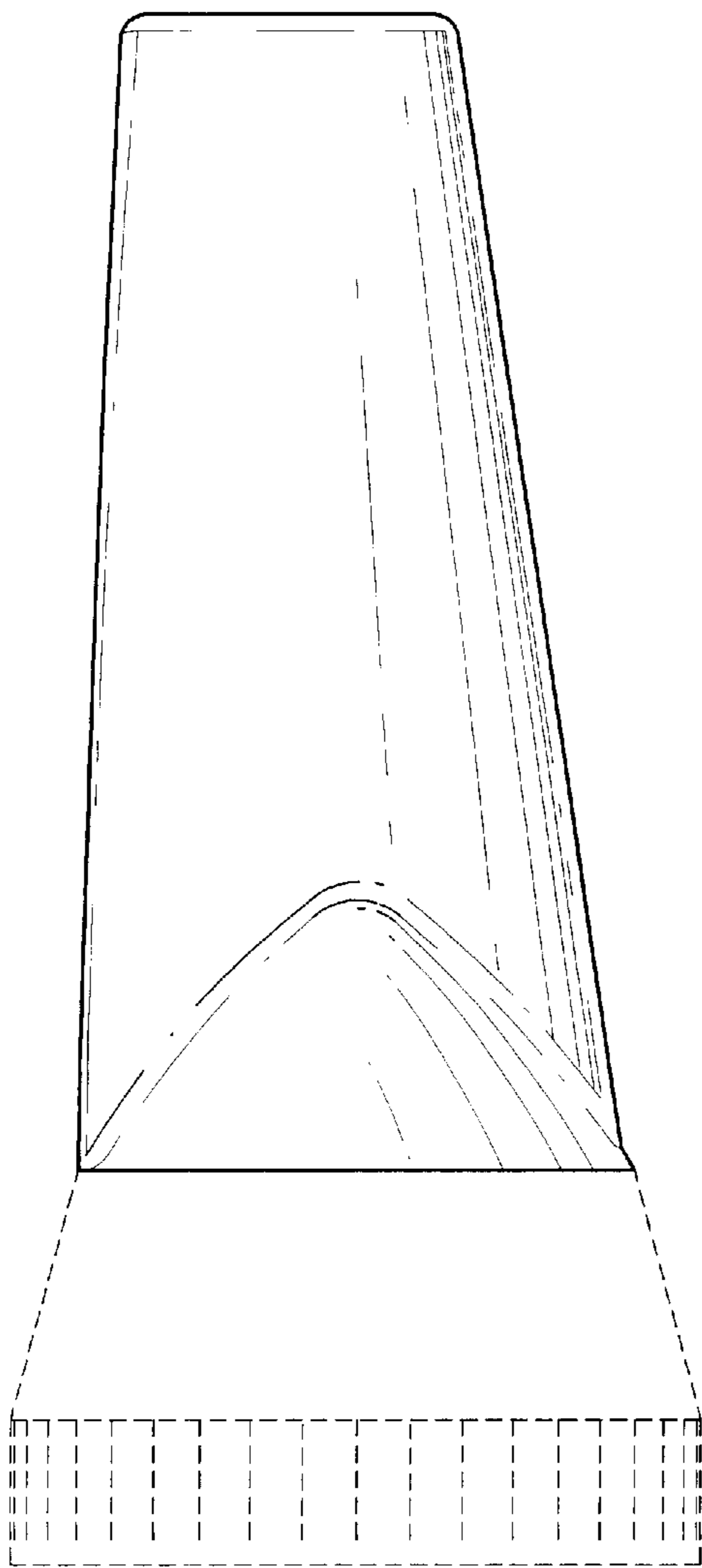

FIG. 3

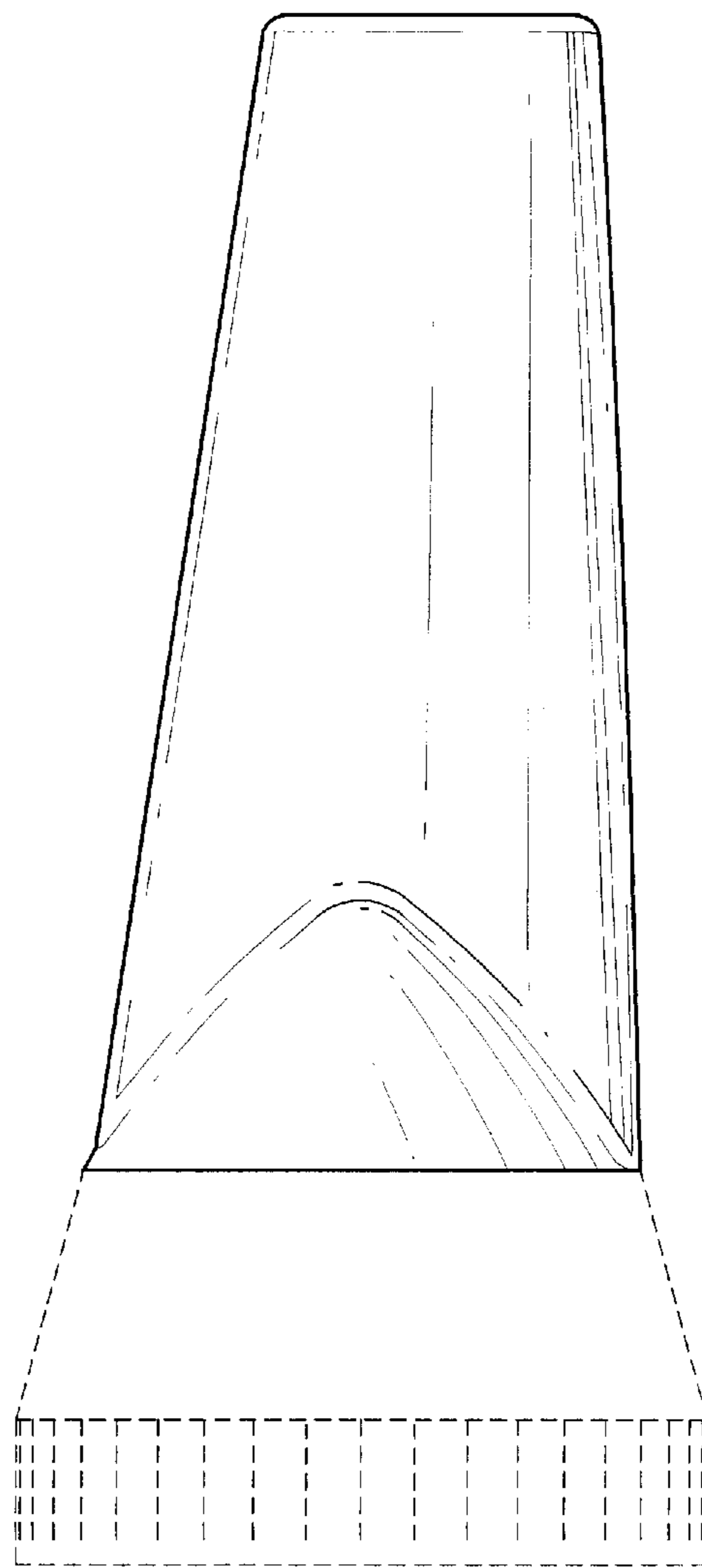

FIG. 4

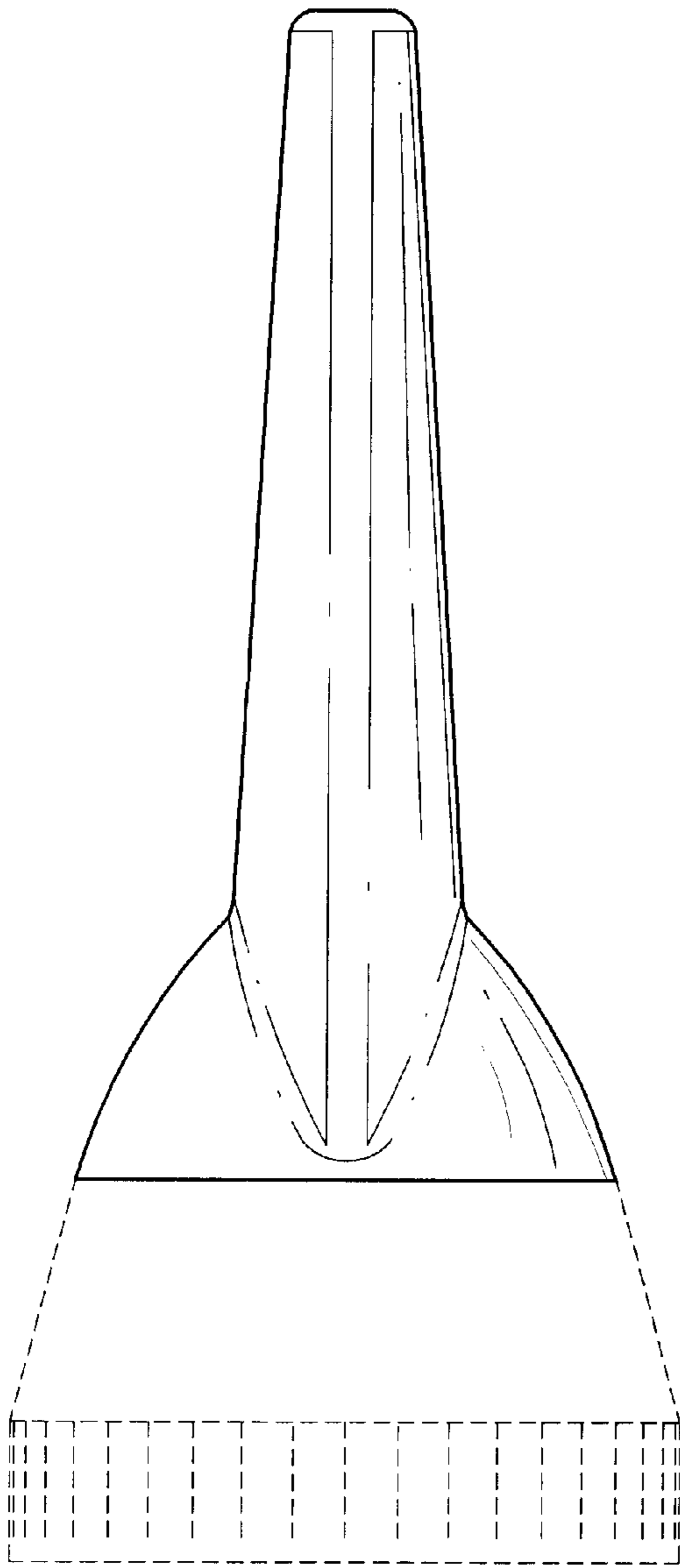

FIG. 5

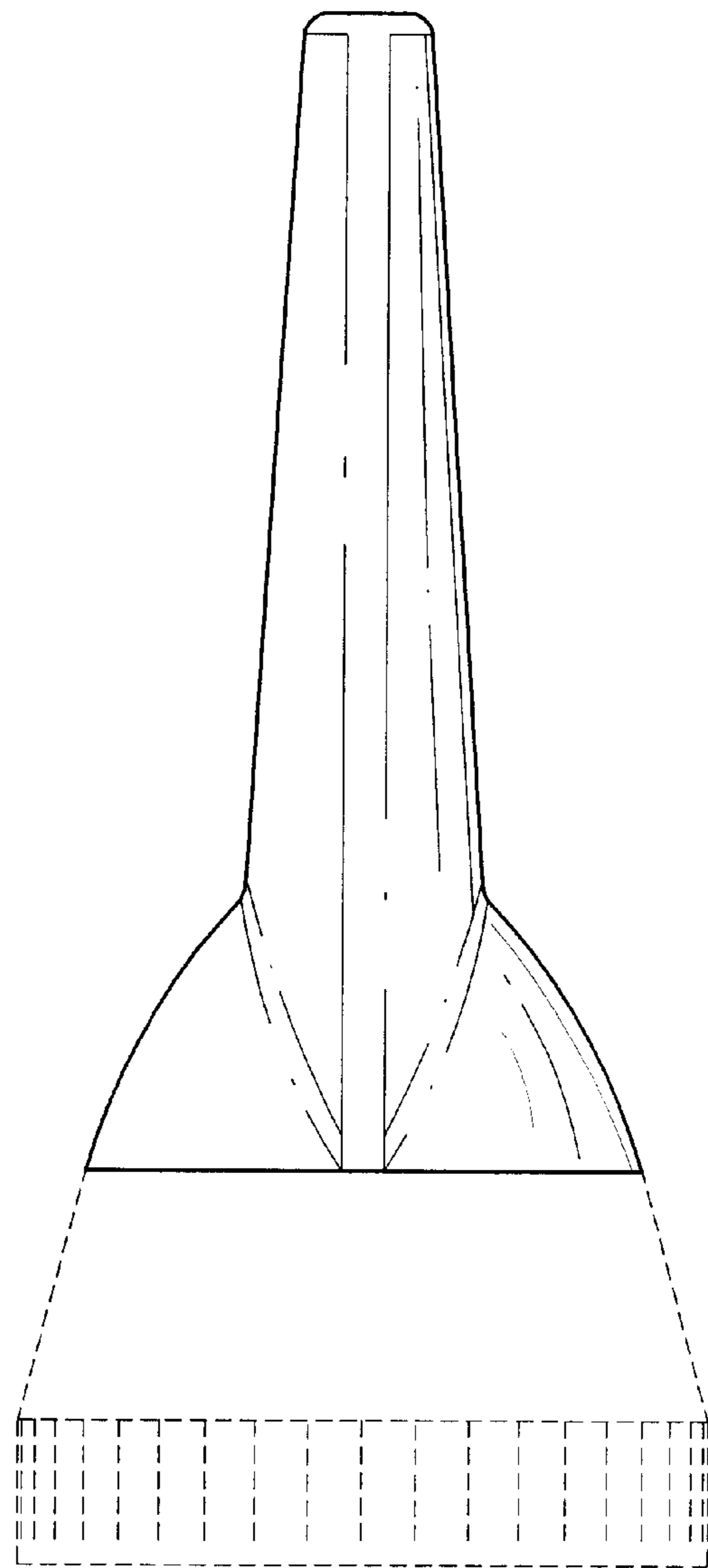

FIG. 6