



US00D542758S

(12) **United States Design Patent**  
**Kim et al.**

(10) **Patent No.:** **US D542,758 S**

(45) **Date of Patent:** **\*\* May 15, 2007**

(54) **PORTABLE PHONE**

(75) Inventors: **Young-Sae Kim**, Palo Alto, CA (US);  
**Chi-Young Ahn**, Seodaemun-Gu (KR);  
**Beom-Ku Han**, Seoul (KR);  
**Chang-Hwan Hwang**, Goyang-Si (KR)

(73) Assignee: **Samsung Electronics Co., Ltd.**,  
Suwon-Si (KR)

(\*\*) Term: **14 Years**

(21) Appl. No.: **29/234,741**

(22) Filed: **Jul. 22, 2005**

(30) **Foreign Application Priority Data**

Jan. 26, 2005 (KR) ..... 30-2005-0002628

(51) **LOC (8) Cl.** ..... **14-03**

(52) **U.S. Cl.** ..... **D14/138**

(58) **Field of Classification Search** ..... D14/341-347,  
D14/138, 137, 147, 218; 455/575.1, 575.3,  
455/575.4, 90.3, 566.1, 556.2; 379/433.01-433.13;  
361/814; 348/14.02

See application file for complete search history.

(56) **References Cited**

**U.S. PATENT DOCUMENTS**

D488,789 S	*	4/2004	Lee	.....	D14/138
D492,276 S	*	6/2004	Walliser et al.	.....	D14/138
D492,660 S	*	7/2004	Kim et al.	.....	D14/138
D496,921 S	*	10/2004	Hwang	.....	D14/138
D503,164 S	*	3/2005	Park et al.	.....	D14/138
D508,240 S	*	8/2005	Lee et al.	.....	D14/138
D508,473 S	*	8/2005	Lee et al.	.....	D14/138
D509,814 S	*	9/2005	Shin et al.	.....	D14/138
D515,060 S	*	2/2006	Lee et al.	.....	D14/138
D515,544 S	*	2/2006	Kim et al.	.....	D14/138
6,999,802 B2	*	2/2006	Kim	.....	455/575.1
D517,038 S	*	3/2006	Lee et al.	.....	D14/138
D519,116 S	*	4/2006	Tanaka et al.	.....	D14/341
D525,959 S	*	8/2006	Kim et al.	.....	D14/138
D531,610 S	*	11/2006	Kim et al.	.....	D14/138

2004/0192398	A1	*	9/2004	Zhu	.....	455/566
2005/0014538	A1	*	1/2005	Hyun et al.	.....	455/575.4
2005/0113155	A1	*	5/2005	Kim et al.	.....	455/575.4
2005/0124394	A1	*	6/2005	Kim et al.	.....	455/575.3
2005/0250532	A1	*	11/2005	Hwang et al.	.....	455/550.1
2005/0255897	A1	*	11/2005	Lee et al.	.....	455/575.4
2005/0266898	A1	*	12/2005	Ahn et al.	.....	455/575.1
2005/0288075	A1	*	12/2005	Geemaert	.....	455/575.4
2006/0025184	A1	*	2/2006	Cho et al.	.....	455/575.4

**OTHER PUBLICATIONS**

Motorola MPx100, announced 1st quarter 2004, [online], [retrieved on Nov. 9, 2006]. Retrieved from Internet ,<URL: <http://www.gsmarena.com>>.\*

Motorola C975, announced 3rd quarter 2004, [online], [retrieved on Nov. 9, 2006]. Retrieved from Internet ,<URL: <http://www.gsmarena.com>>.\*

Motorola ROKR E1, announced Sep. 2005, [online], [retrieved on Nov. 9, 2006]. Retrieved from Internet ,<URL: <http://www.gsmarena.com>>.\*

\* cited by examiner

*Primary Examiner*—Jeffrey Asch

*Assistant Examiner*—Bridget L. Eland

(74) *Attorney, Agent, or Firm*—Staas & Halsey LLP

(57) **CLAIM**

The ornamental design for the portable phone, as shown and described.

**DESCRIPTION**

FIG. 1 is a perspective view of the portable phone showing our design;

FIG. 2 is a front view thereof;

FIG. 3 is a rear view thereof;

FIG. 4 is a left side view thereof;

FIG. 5 is a right side view thereof;

FIG. 6 is a top plan view thereof;

FIG. 7 is a bottom plan view thereof; and,

FIG. 8 is a front view showing the movable panel rotated to an alternate position.

**1 Claim, 5 Drawing Sheets**

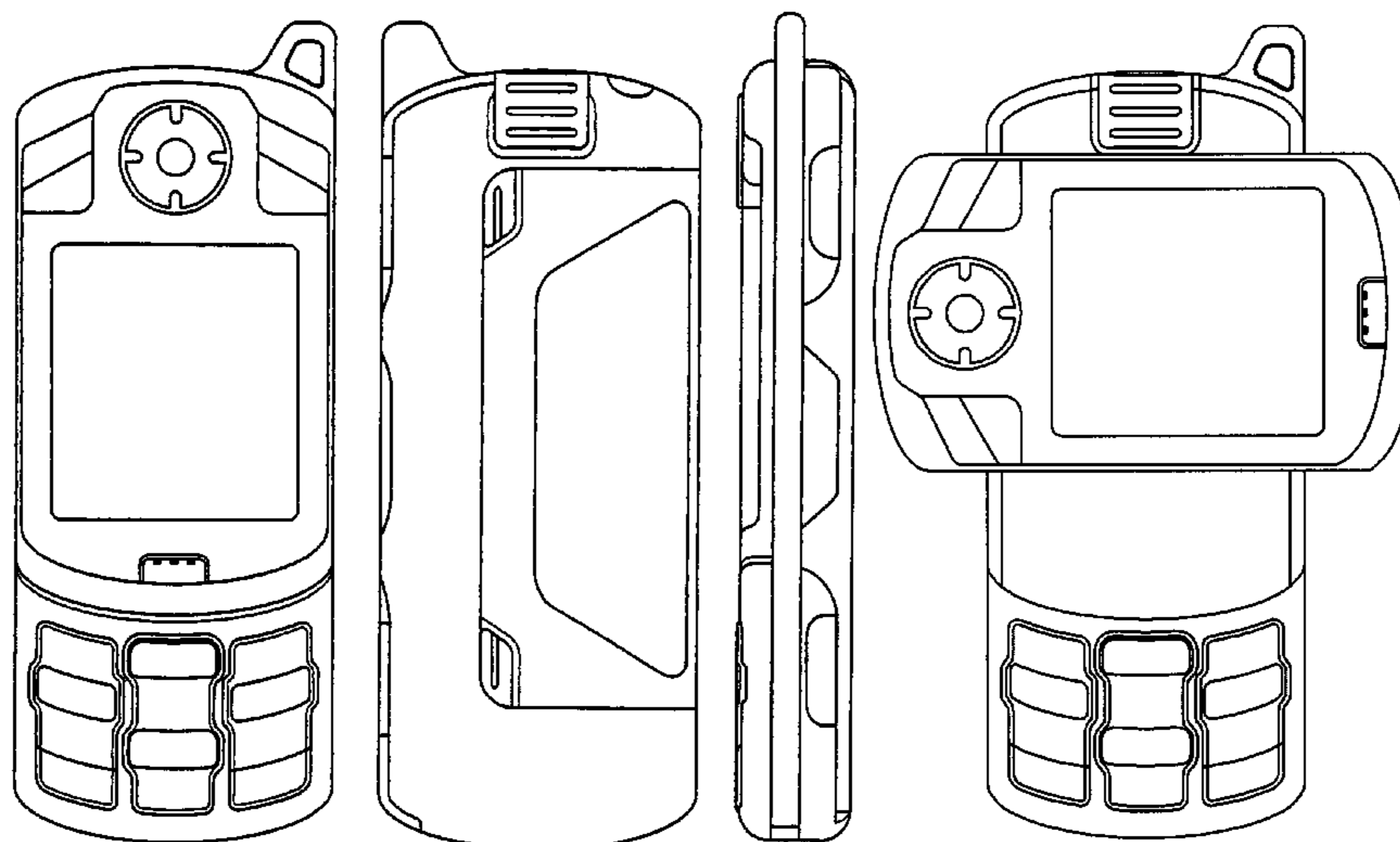

**FIG. 1**

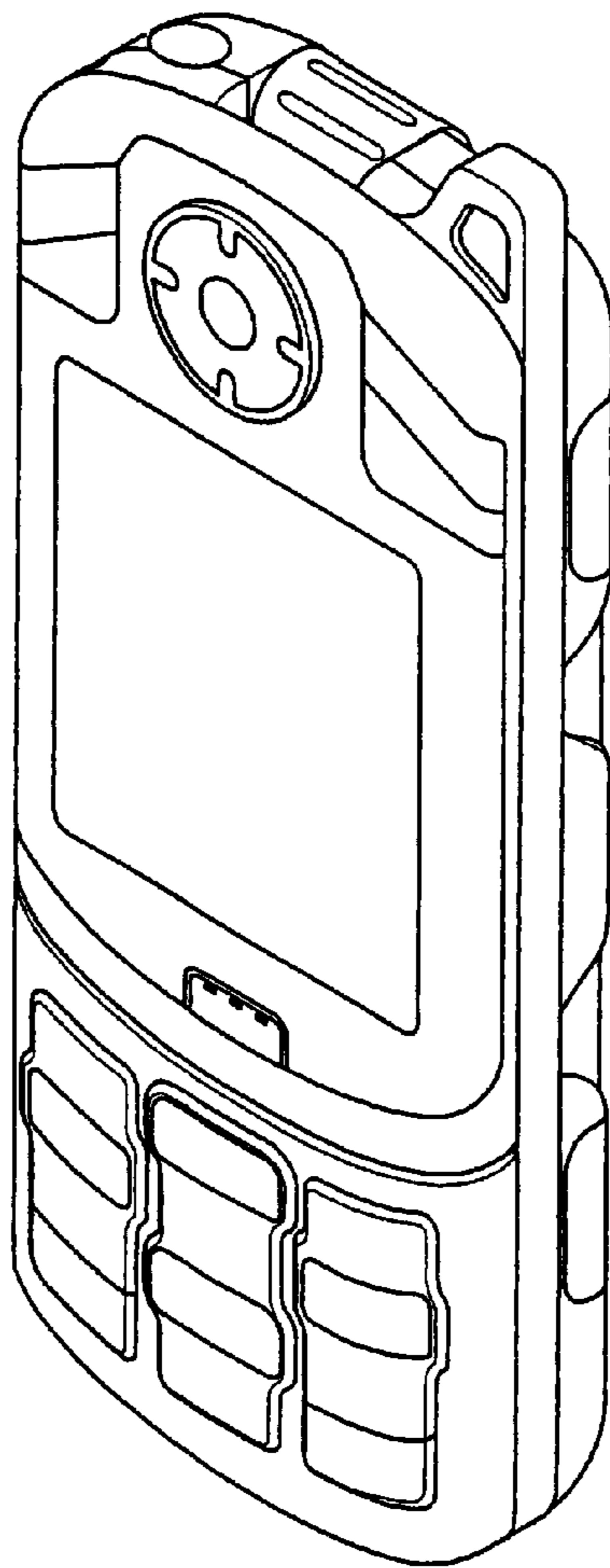

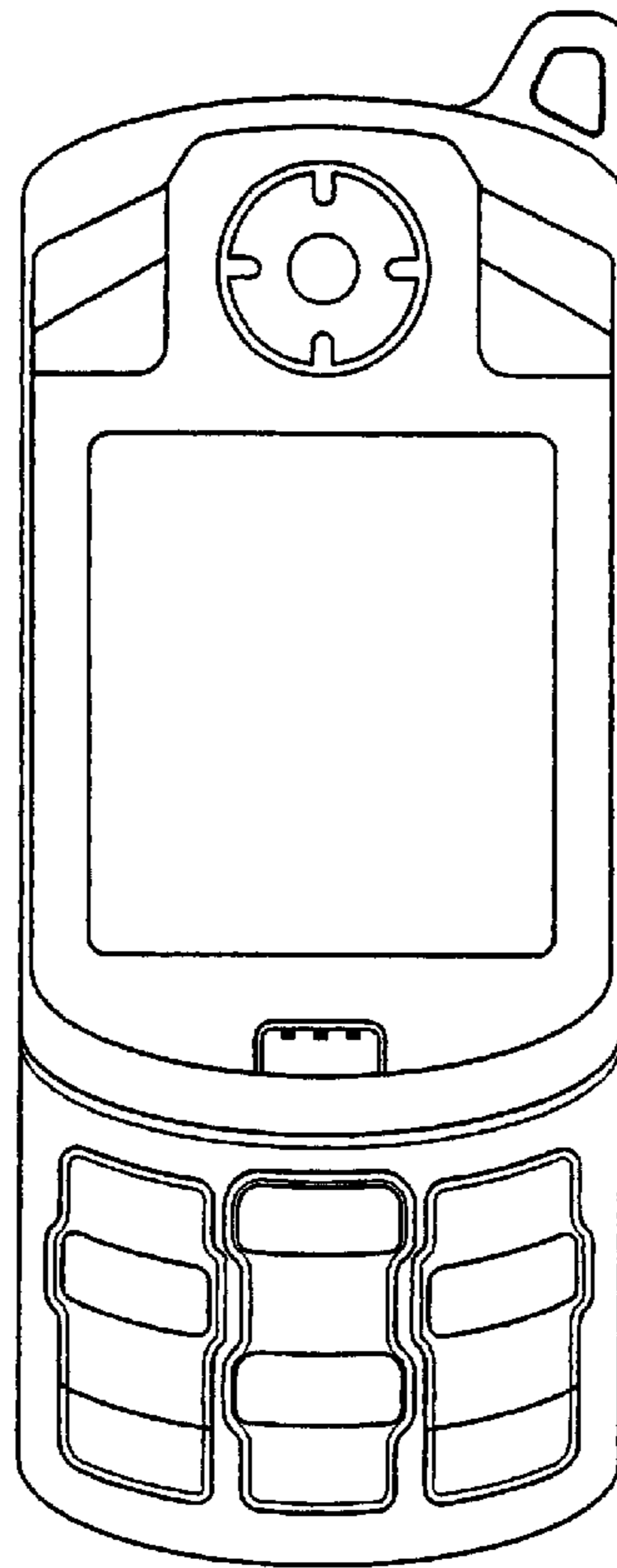

FIG. 2

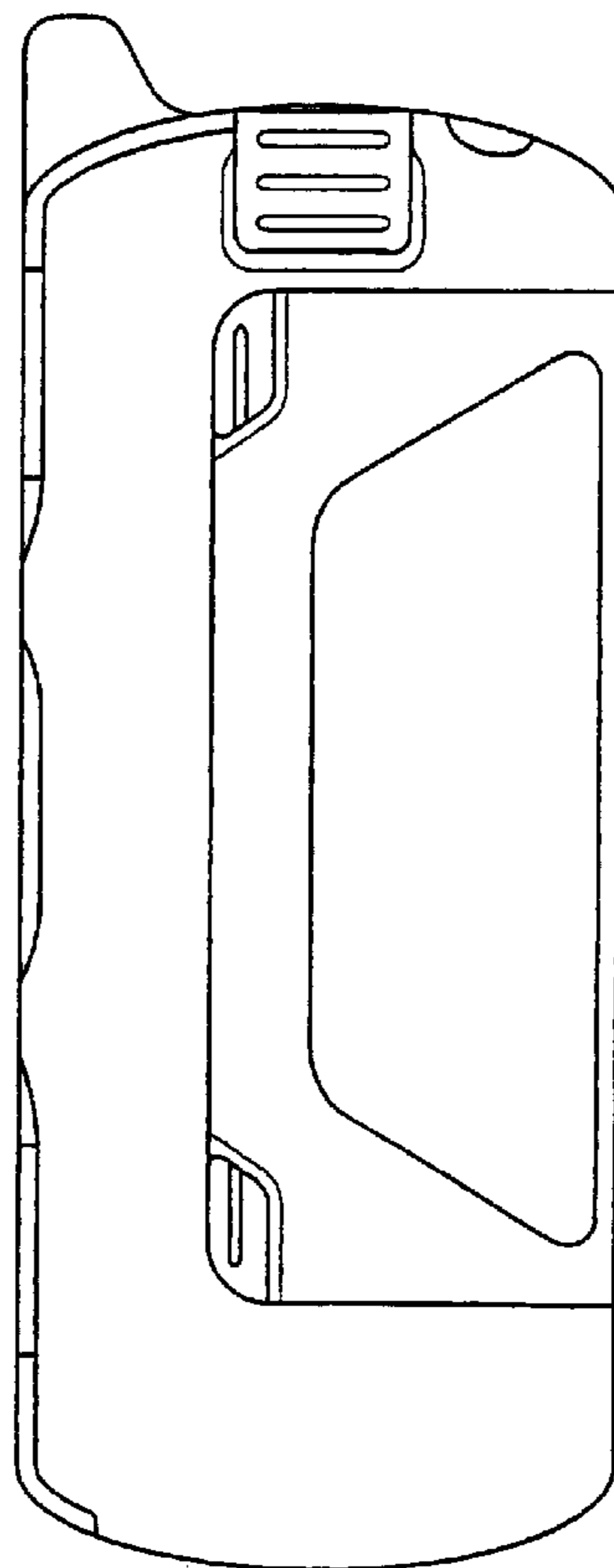
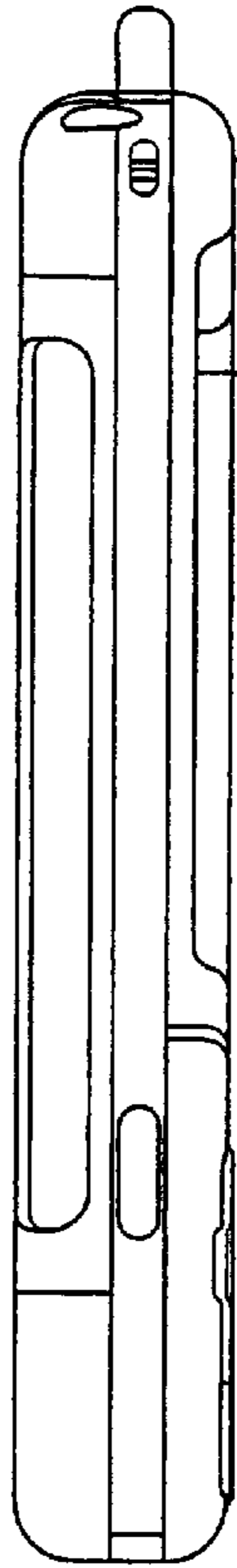
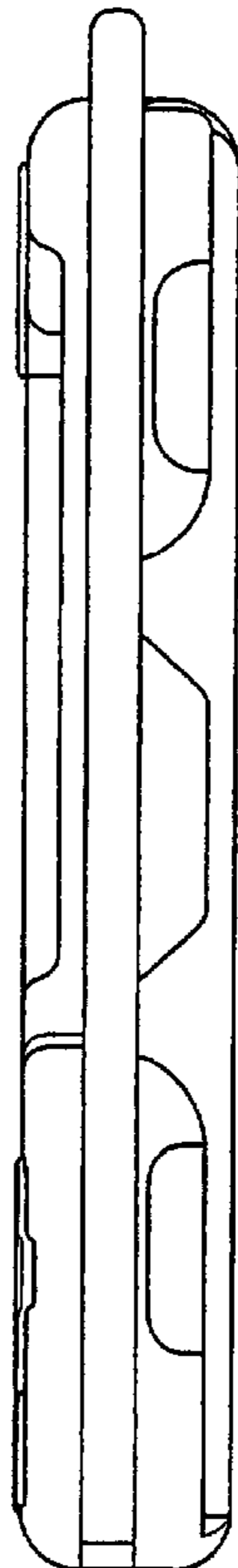

FIG. 3

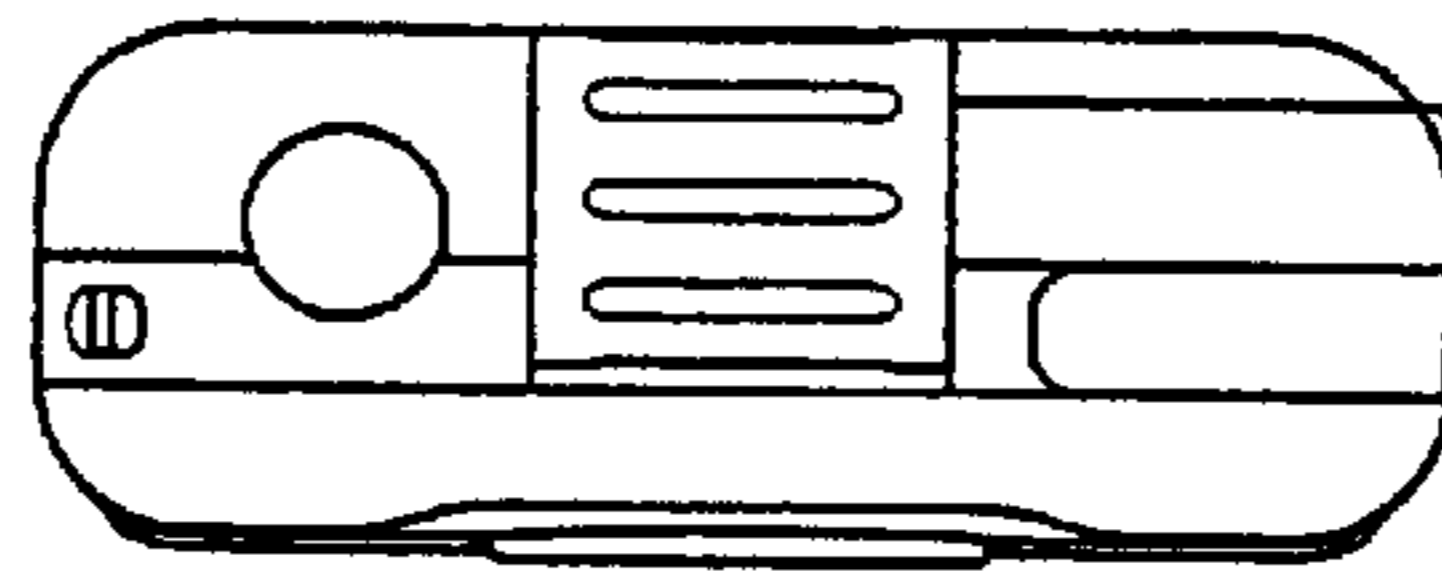

**FIG. 4**

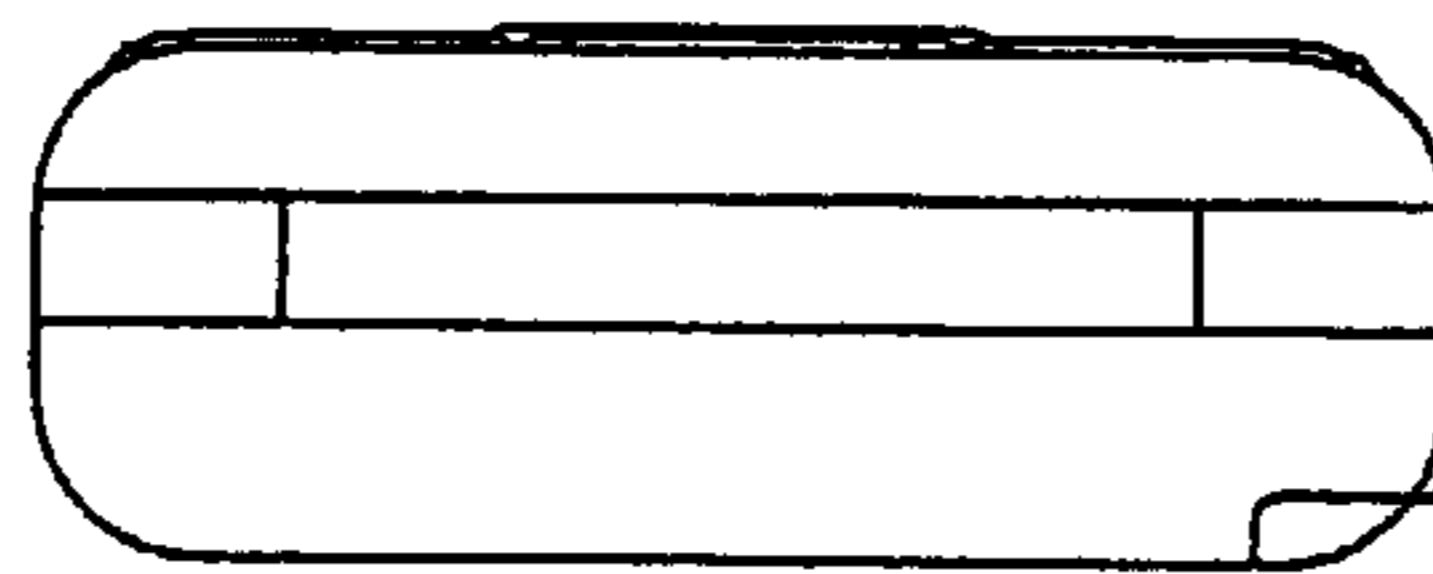

**FIG. 5**

**FIG. 6**



**FIG. 7**



**FIG. 8**

