



US00D542755S

(12) **United States Design Patent**  
**Choi et al.**

(10) **Patent No.:** **US D542,755 S**  
(45) **Date of Patent:** **\*\* May 15, 2007**

(54) **CELLULAR PHONE**

(75) Inventors: **Hyok Su Choi**, Kyungki-Do (KR);  
**Yoon Young Cho**, Seoul (KR); **Chang**  
**Hwan Hwang**, Kyungki-Do (KR)

(73) Assignee: **Samsung Electronics Co., Ltd.** (KR)

(\*\*) Term: **14 Years**

(21) Appl. No.: **29/232,416**

(22) Filed: **Jun. 17, 2005**

(30) **Foreign Application Priority Data**

May 3, 2005 (KR) ..... 30-2005-0014972

(51) **LOC (8) Cl.** ..... **14-03**

(52) **U.S. Cl.** ..... **D14/138**

(58) **Field of Classification Search** ..... D14/191,  
D14/138, 147-148, 247-248, 144, 496, 156,  
D14/341-347; 379/433.01-433.13; 455/575.3,  
455/566, 575.1, 556.1, 556.2, 90.3; D21/517;  
D16/208

See application file for complete search history.

(56) **References Cited**

**U.S. PATENT DOCUMENTS**

D408,030 S	*	4/1999	Richards et al.	.....	D14/138
D483,341 S	*	12/2003	Rausch et al.	.....	D14/138
D484,862 S	*	1/2004	Yang	.....	D14/138
D486,809 S	*	2/2004	Hwang	.....	D14/138
D487,443 S	*	3/2004	Yoon	.....	D14/138
D487,444 S	*	3/2004	Yoon	.....	D14/138
D489,699 S	*	5/2004	Hwang et al.	.....	D14/138
D495,672 S	*	9/2004	Jeon et al.	.....	D14/138
D501,189 S	*	1/2005	Lodato et al.	.....	D14/138
D501,838 S	*	2/2005	Kim et al.	.....	D14/138
D505,125 S	*	5/2005	Ahn et al.	.....	D14/138
D505,126 S	*	5/2005	Ahn et al.	.....	D14/138
D508,030 S	*	8/2005	Jeoung et al.	.....	D14/138
D508,685 S	*	8/2005	Kim et al.	.....	D14/138
D509,494 S	*	9/2005	Cho et al.	.....	D14/138
D509,815 S	*	9/2005	Jang	.....	D14/138

(Continued)

**OTHER PUBLICATIONS**

Samsung X900 telephone, announced 1st quarter 2004, [online], [retrieved on Aug. 27, 2006]. Retrieved from Internet, <URL: http://www.gsmarena.com>.\*

Pantech GF200 telephone, announced 2nd quarter 2004, [online], [retrieved on Aug. 27, 2006]. Retrieved from Internet, <URL: http://www.gsmarena.com>.\*

Sagem MY C-5w telephone, announced 3rd quarter 2003, [online], [retrieved on Aug. 27, 2006]. Retrieved from Internet, <URL: http://www.gsmarena.com>.\*

Pantech GF100 telephone, announced 1st quarter 2005, [online], [retrieved on Aug. 27, 2006]. Retrieved from Internet, <URL: http://www.gsmarena.com>.\*

Sagem MY C-3s telephone, announced 1st quarter 2004, [online], [retrieved on Aug. 27, 2006]. Retrieved from Internet, <URL: http://www.gsmarena.com>.\*

Motorola A760 telephone, announced 2003, [online], [retrieved on Aug. 27, 2006]. Retrieved from Internet, <URL: http://www.gsmarena.com>.\*

*Primary Examiner*—Jeffrey Asch

(74) *Attorney, Agent, or Firm*—Irving Keschner

(57) **CLAIM**

The ornamental design for cellular phone, as shown.

**DESCRIPTION**

FIG. 1 is a perspective view of the ornamental design of the present invention;

FIG. 2 is a front elevational view of the ornamental design of the present invention;

FIG. 3 is a rear elevational view of the ornamental design of the present invention;

FIG. 4 is a left side elevational view of the ornamental design of the present invention;

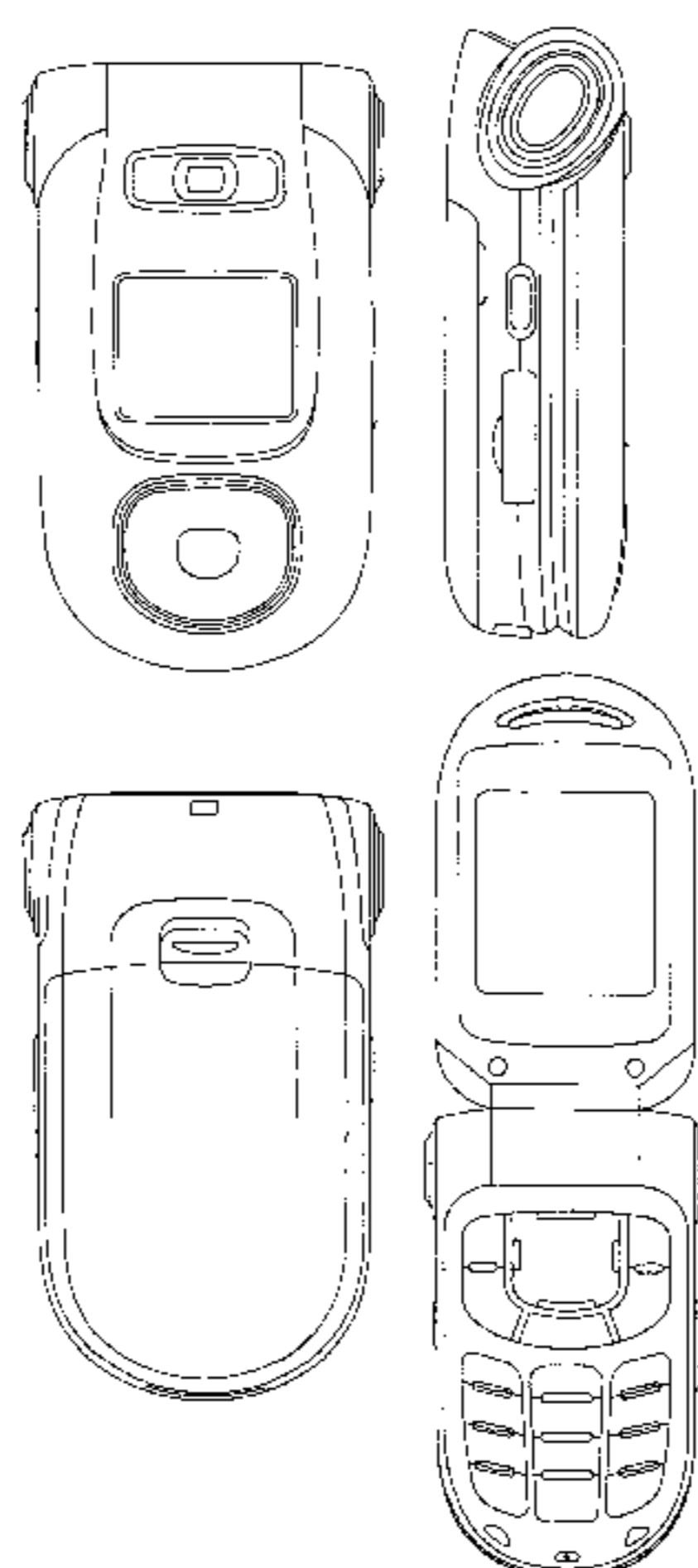
FIG. 5 is a right side elevational view of the ornamental design of the present invention;

FIG. 6 is a top plan view of the ornamental design of the present invention;

FIG. 7 is a bottom view of the ornamental design of the present invention; and,

FIG. 8 illustrates the cellular phone of the present invention in the open position.

**1 Claim, 7 Drawing Sheets**



# US D542,755 S

Page 2

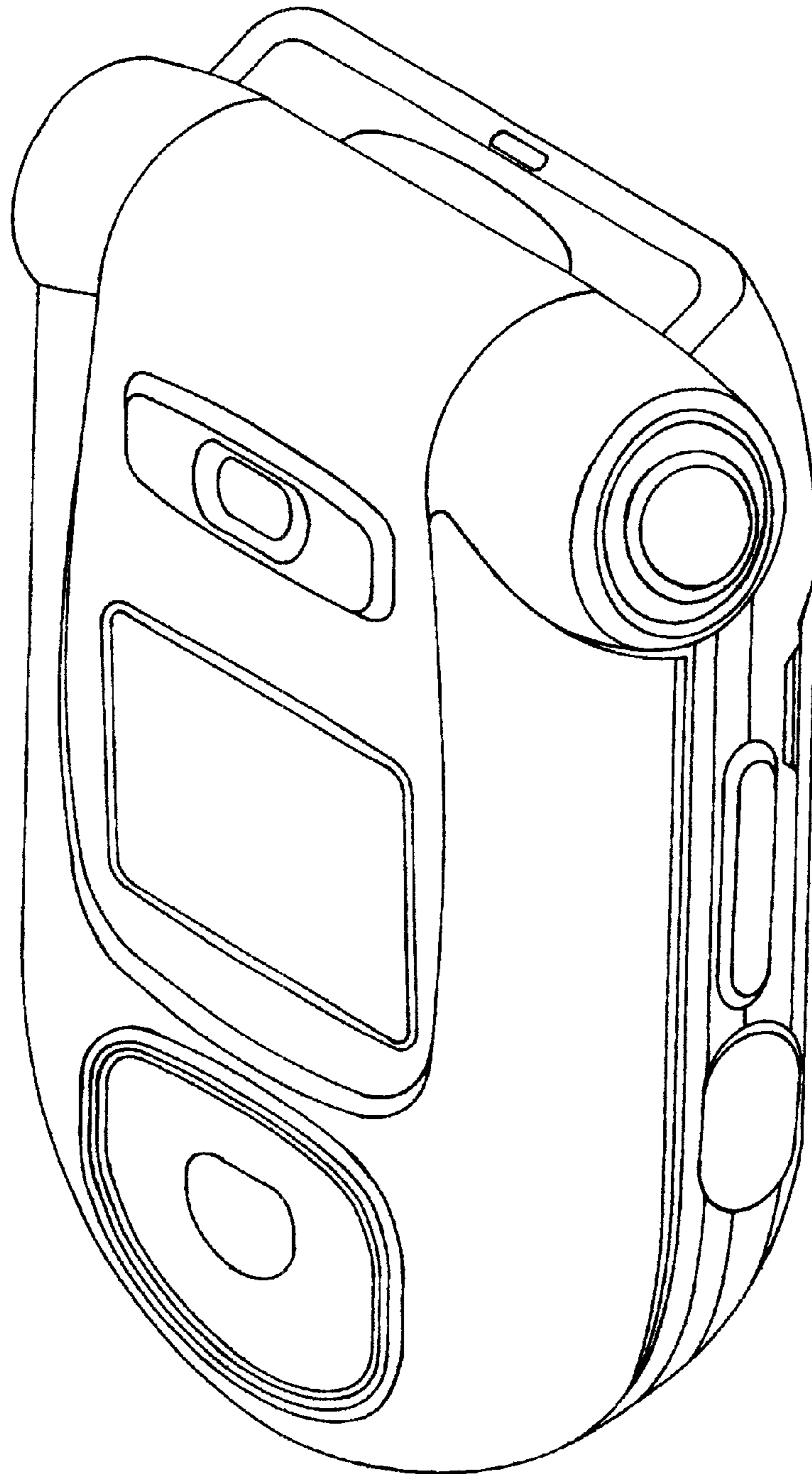
---

## U.S. PATENT DOCUMENTS

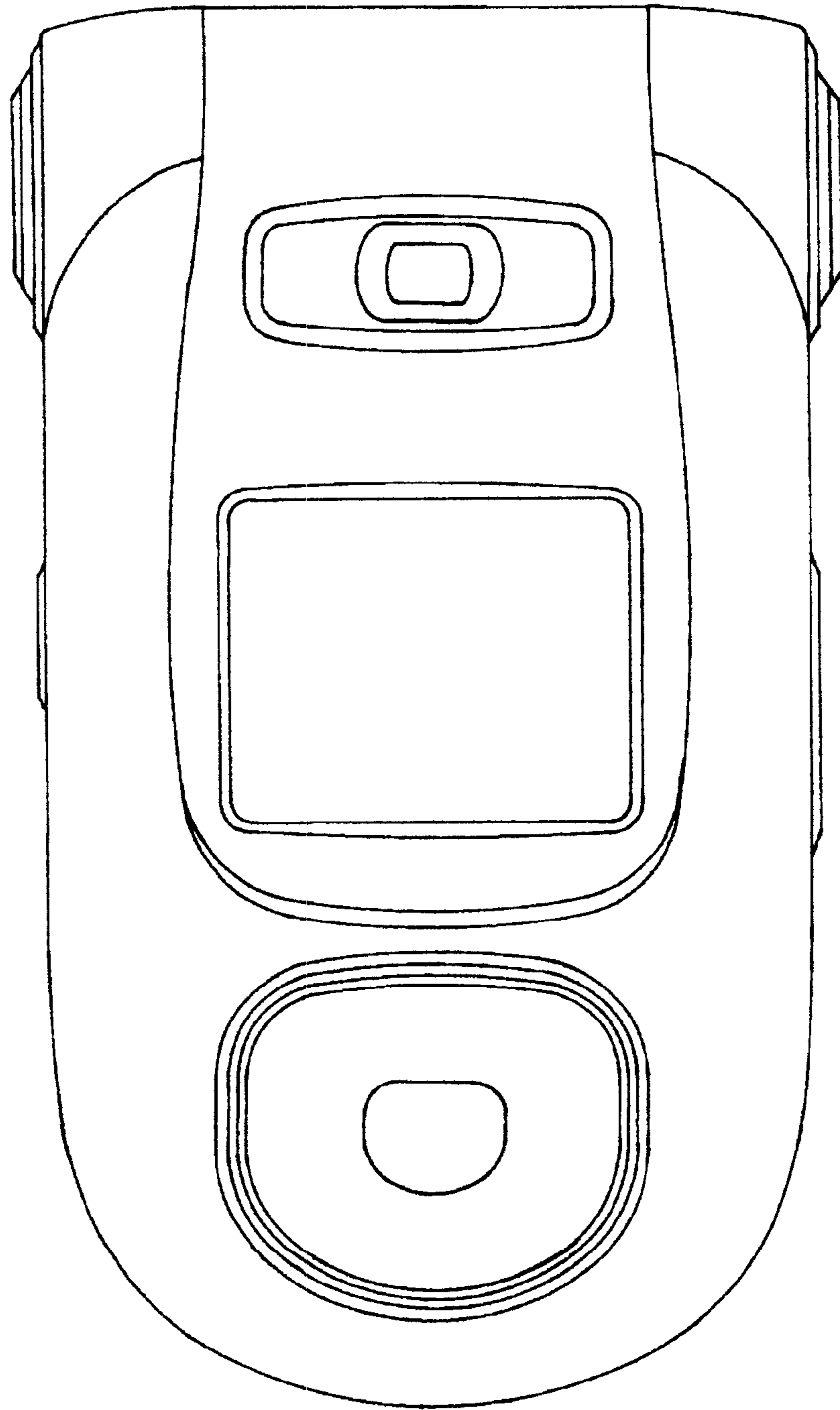
D510,922 S	*	10/2005	Kim et al. ....	D14/138	D517,517 S	*	3/2006	Li et al. ....	D14/138
D511,335 S	*	11/2005	Jeoung et al. ....	D14/138	D518,807 S	*	4/2006	Choi et al. ....	D14/138
D511,509 S	*	11/2005	Kim et al. ....	D14/138	D520,482 S	*	5/2006	Kim et al. ....	D14/138
D512,038 S	*	11/2005	Kim et al. ....	D14/138	D520,485 S	*	5/2006	Cho ....	D14/138
D512,395 S	*	12/2005	Kim et al. ....	D14/138	D521,479 S	*	5/2006	Cho et al. ....	D14/138
D512,396 S	*	12/2005	Kim et al. ....	D14/138	D522,991 S	*	6/2006	Yun et al. ....	D14/138
D513,505 S	*	1/2006	Lee ....	D14/138	2004/0097258 A1	*	5/2004	Lee et al. ....	455/550.1

\* cited by examiner

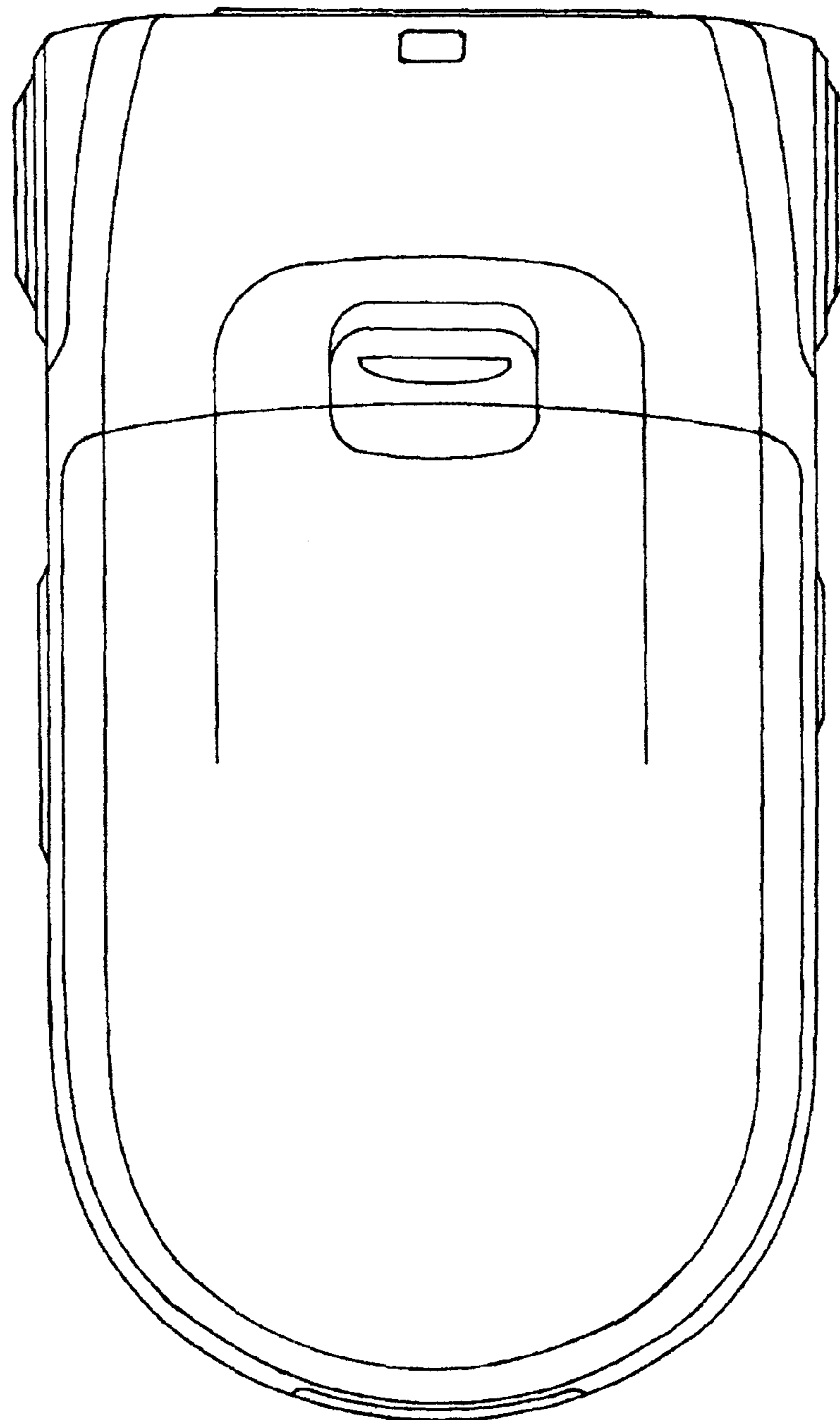
*FIG. 1*



*FIG. 2*

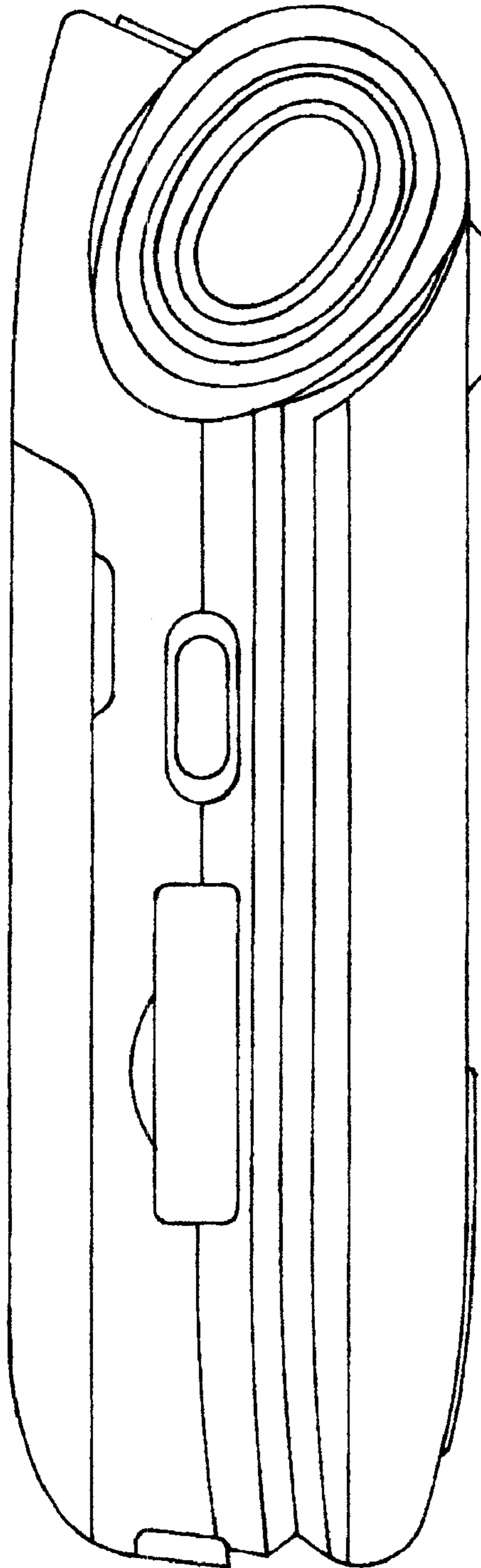


*FIG. 3*

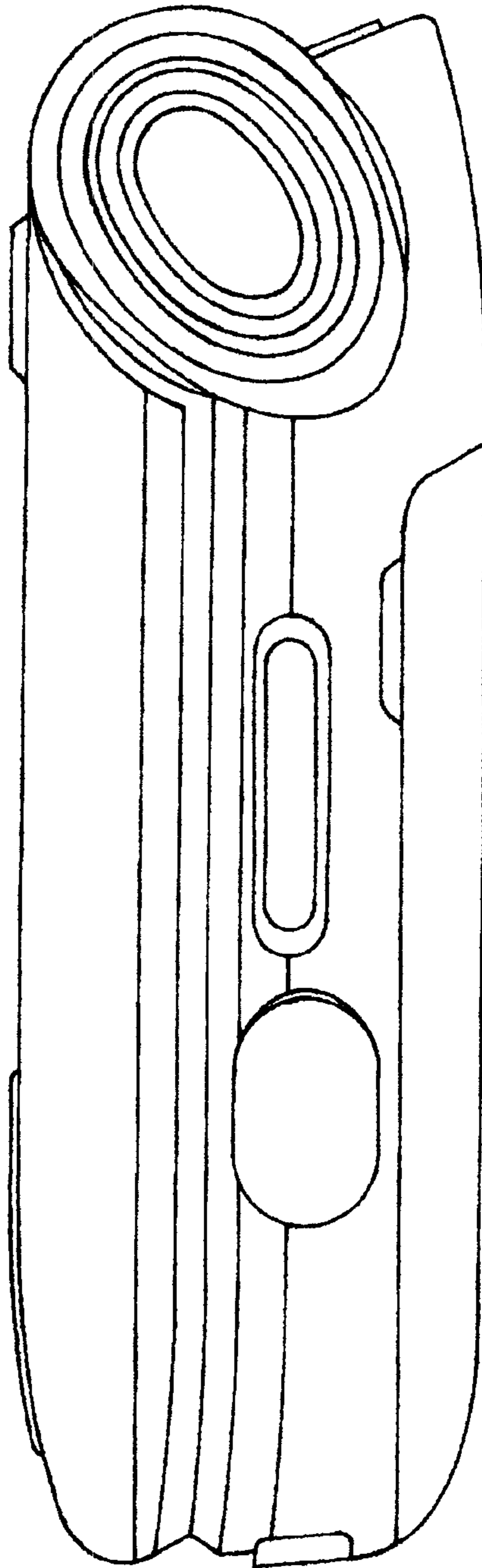




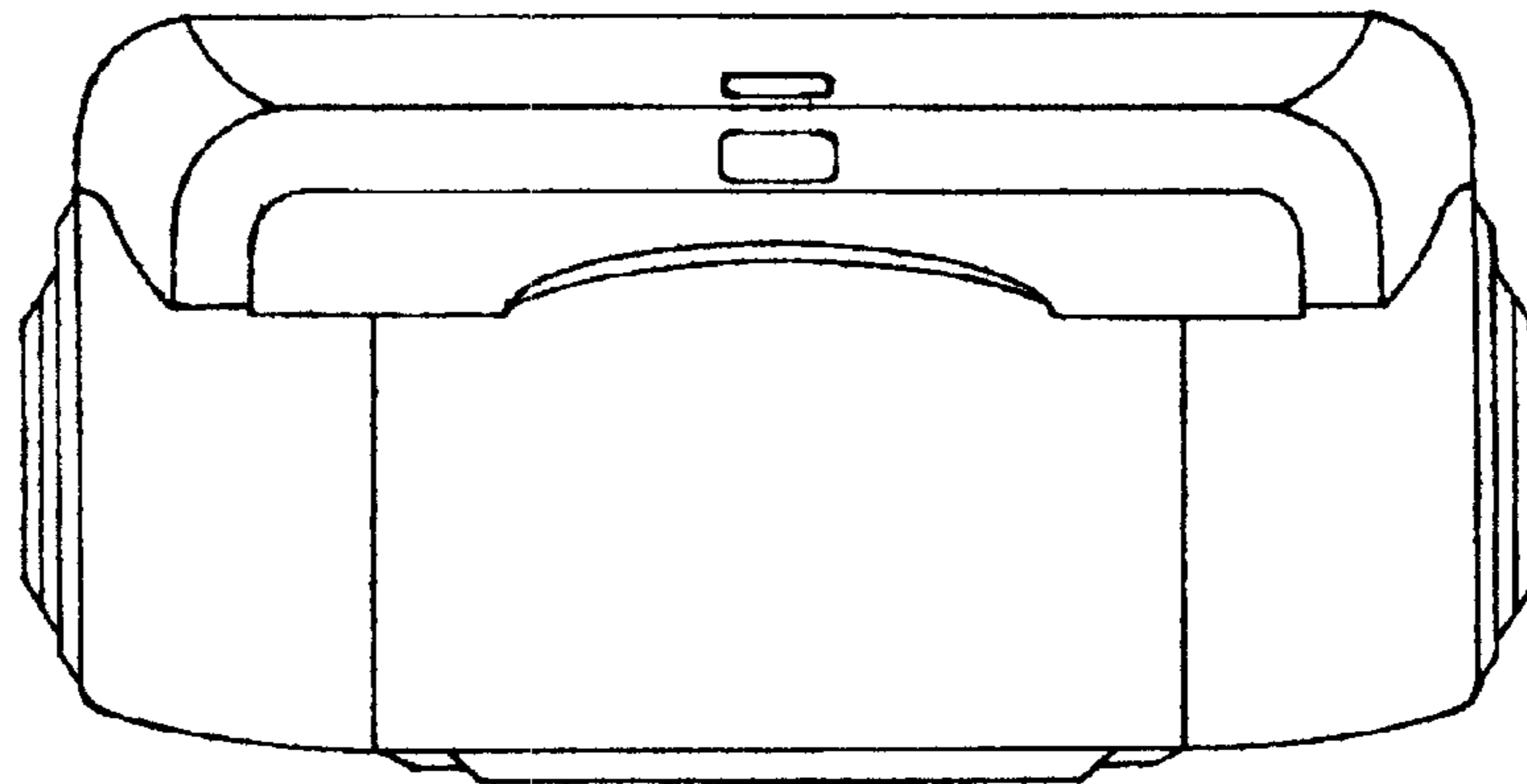
*FIG. 4*



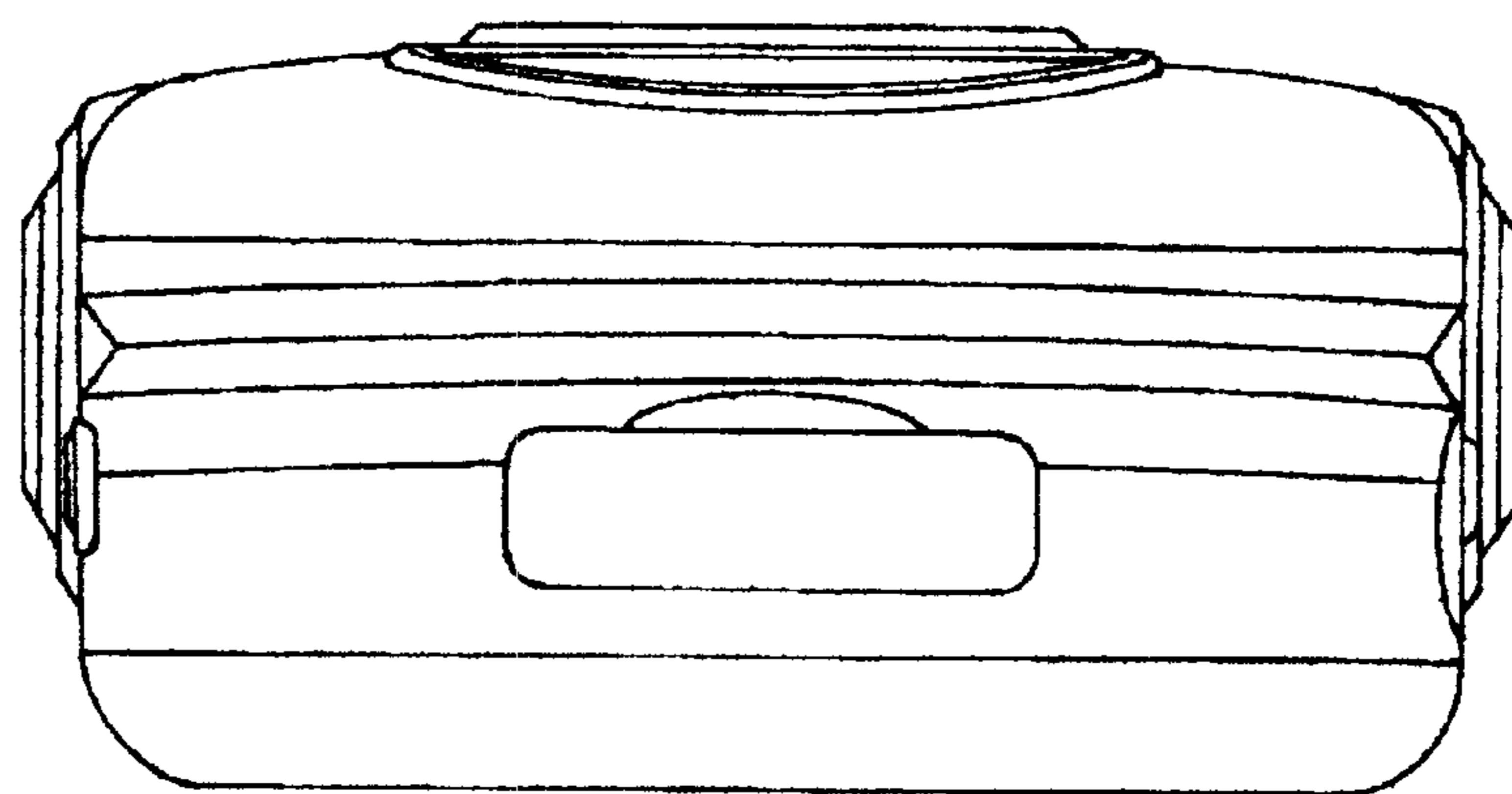
*FIG. 5*



*FIG. 6*



*FIG. 7*





*FIG. 8*

