



US00D542690S

(12) **United States Design Patent**
Miller et al.

(10) **Patent No.:** **US D542,690 S**

(45) **Date of Patent:** **** May 15, 2007**

(54) **RING PENDANT**

(75) Inventors: **Goldi Miller**, Milwaukee, WI (US);
Myra Mouloudji, Milwaukee, WI (US)

(73) Assignee: **M & G Partners, LLP**, Milwaukee,
WI (US)

(**) Term: **14 Years**

(21) Appl. No.: **29/233,906**

(22) Filed: **Jul. 10, 2005**

(51) **LOC (8) Cl.** **11-01**

(52) **U.S. Cl.** **D11/26; D11/79; D11/1**

(58) **Field of Classification Search** D11/1-4,
D11/6, 9-10, 12, 17, 22, 26-50, 53-79, 81,
D11/84, 91-95, 103, 108; 63/1.13, 3-4, 12-13,
63/14.1-14.9, 15, 15.1-15.4, 15.45, 15.5-15.6,
63/15.65, 15.7-15.9, 20, 22-23, 26-29, 35,
63/43

See application file for complete search history.

(56) **References Cited**

U.S. PATENT DOCUMENTS

D76,209 S	*	8/1928	Stewart	D11/37
D149,653 S	*	5/1948	Koven	D11/38
2,453,955 A	*	11/1948	Younghusband	63/15
2,653,402 A	*	9/1953	Bonagura	63/15
3,307,374 A	*	3/1967	Kirshbaum	63/15
D260,620 S	*	9/1981	Blum	D11/3
D376,557 S	*	12/1996	Mottl	D11/37
D389,423 S	*	1/1998	Wein	D11/37
D390,150 S	*	2/1998	Wein	D11/37
D393,225 S	*	4/1998	Morrison	D11/26
D396,822 S	*	8/1998	Morrison	D11/26
D423,977 S	*	5/2000	Morrison	D11/36
6,101,843 A	*	8/2000	Nagano	63/15.4
D445,716 S	*	7/2001	Goldstein	D11/26
D450,009 S	*	11/2001	Molfese	D11/26
D460,926 S	*	7/2002	Zillig	D11/26
D470,429 S	*	2/2003	Bonnet	D11/3
D473,155 S	*	4/2003	Bonnet	D11/26
2005/0268653 A1	*	12/2005	Kaplan	63/15.7

OTHER PUBLICATIONS

Charmed Life Jewelry; all Discs collections; http://www.charmedlifejewelry.com/catalog_2_c90500.html; pp. 1-4; Copyright 2003.*

Charmed Life Jewelry; Affirmation Disc Collection; http://www.charmedlifejewelry.com/catalog_2_c17618.html; pp. 1-2; Copyright 2003.*

Undee Bandz Silicone Bracelets; http://toptrenz.com/store_gallery_Nylonz.htm; pp. 3 & 8 of 8; Copyright 2004.*

Undee Bandz Nylonz Chokers and Bracelets; http://toptrenz.com/store_gallery_Nylonz.htm; pp. 4-6 & 8 of 8; Copyright 2004.*

* cited by examiner

Primary Examiner—Cathy Anne MacCormac

(74) *Attorney, Agent, or Firm*—Brian G. Gilpin; Godfrey & Kahn, S.C.

(57) **CLAIM**

The ornamental design for a ring pendant, as shown and described.

DESCRIPTION

FIG. 1 is a perspective view of a first embodiment of a ring pendant showing our new design;

FIG. 2 is a front elevational view thereof, the rear elevational view is identical to the front;

FIG. 3 is a left side elevational view thereof, the right side elevational view is identical to the left side;

FIG. 4 is a perspective view of a second embodiment of FIG. 1;

FIG. 5 is a front elevational view thereof, the rear elevational view is identical to the front;

FIG. 6 is a left side elevational view thereof, the right side elevational view is identical to the left side;

FIG. 7 is a perspective view of a third embodiment of FIG. 1;

FIG. 8 is a front elevational view thereof, the rear elevational view is identical to the front;

FIG. 9 is a left side elevational view thereof, the right side elevational view is identical to the left side;

FIG. 10 is a perspective view of a fourth embodiment of FIG. 1;

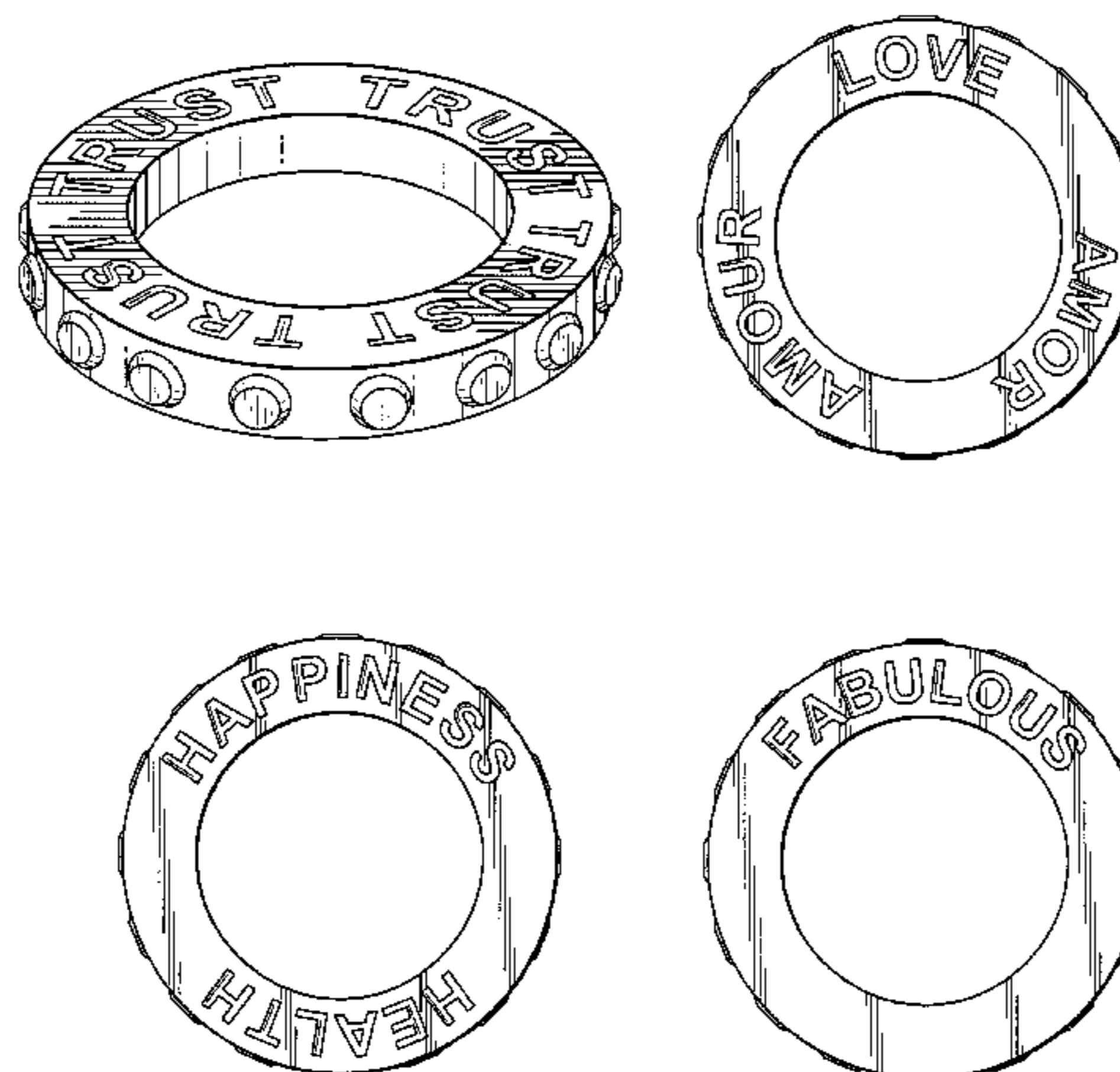

FIG. **203** is a front elevational view thereof, the rear elevational view is identical to the front; and,
FIG. **204** is a left side elevational view thereof, the right side elevational view is identical to the left side.

1 Claim, 68 Drawing Sheets

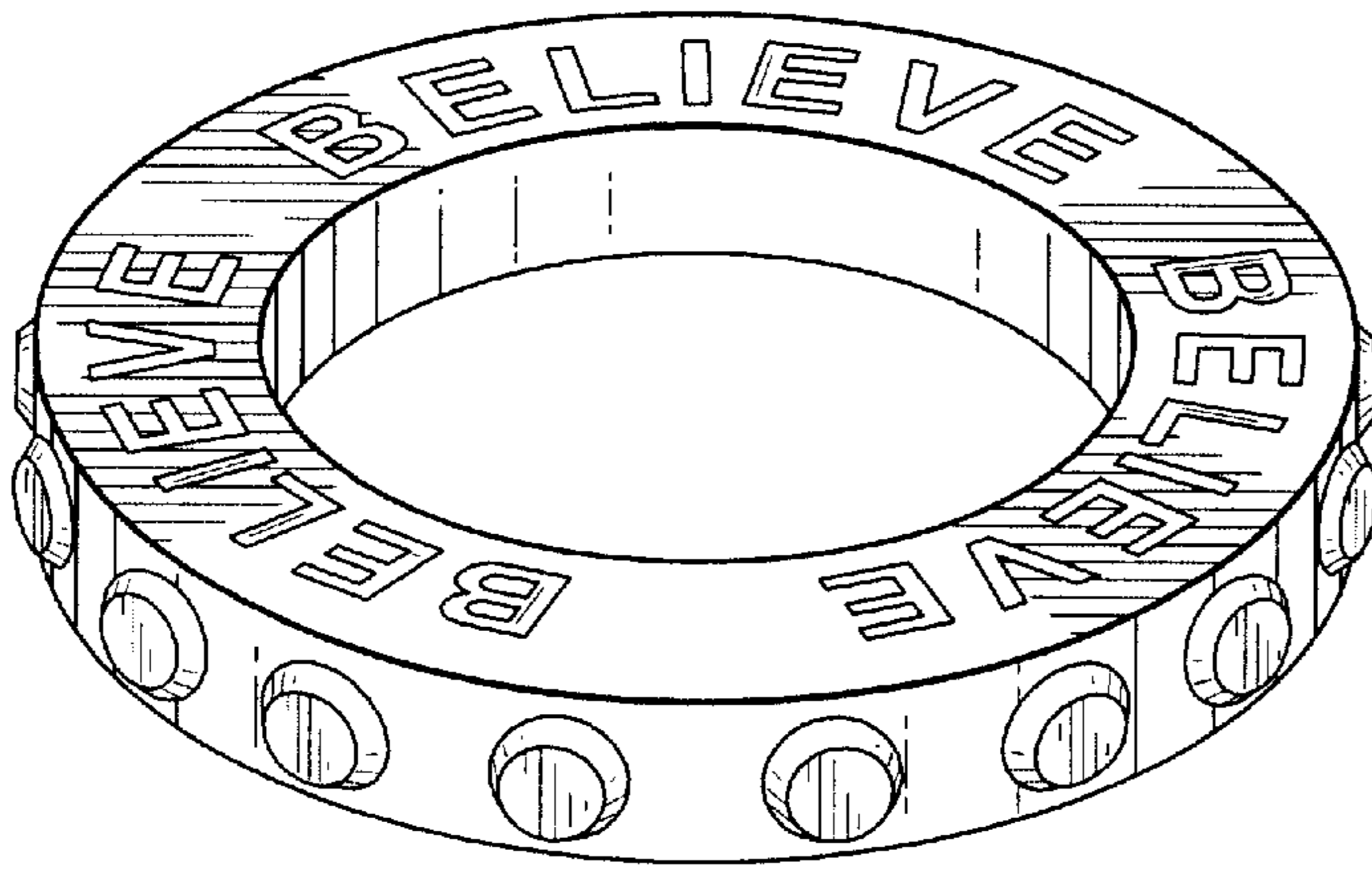

FIG. 1

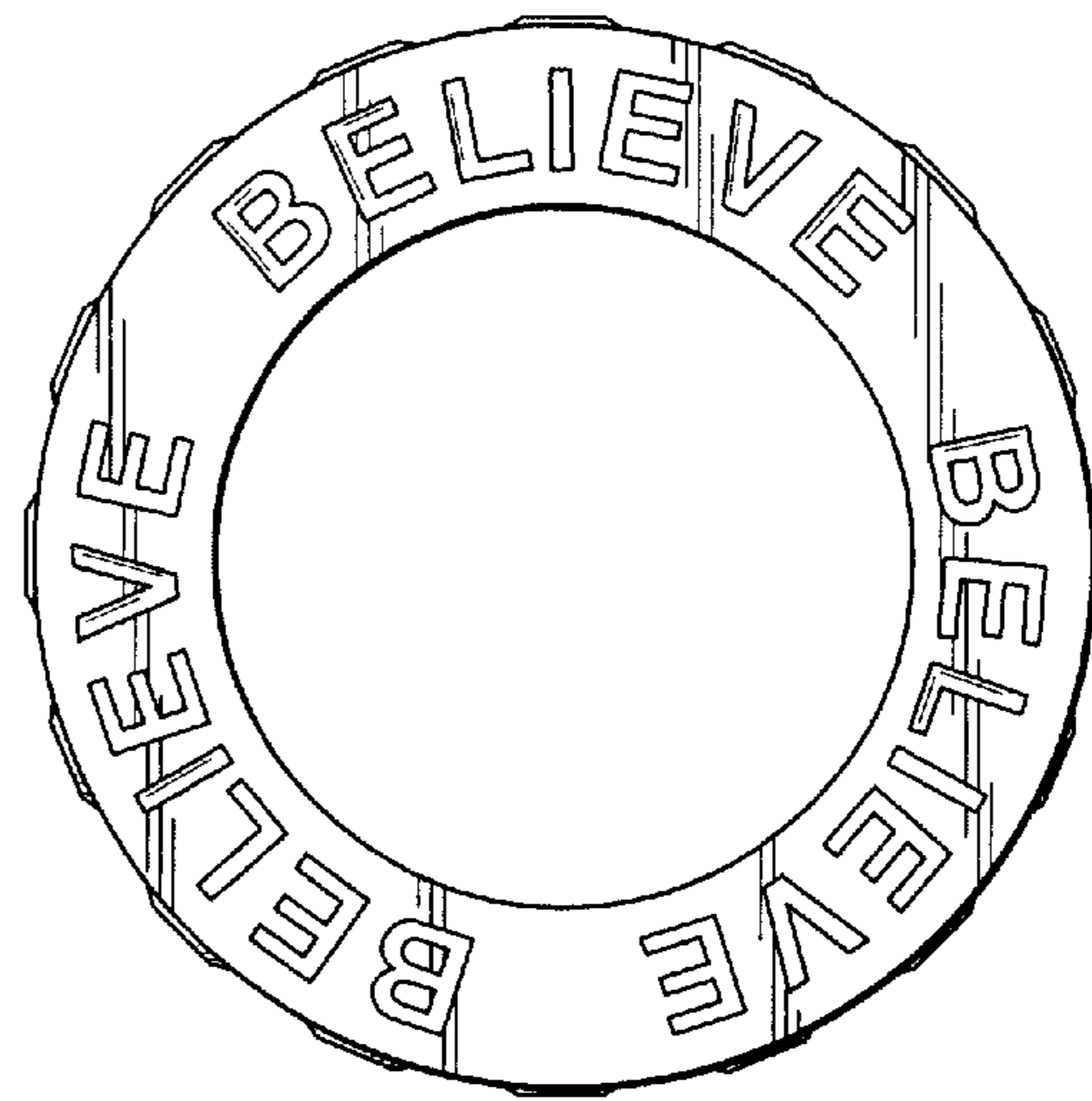

FIG. 2

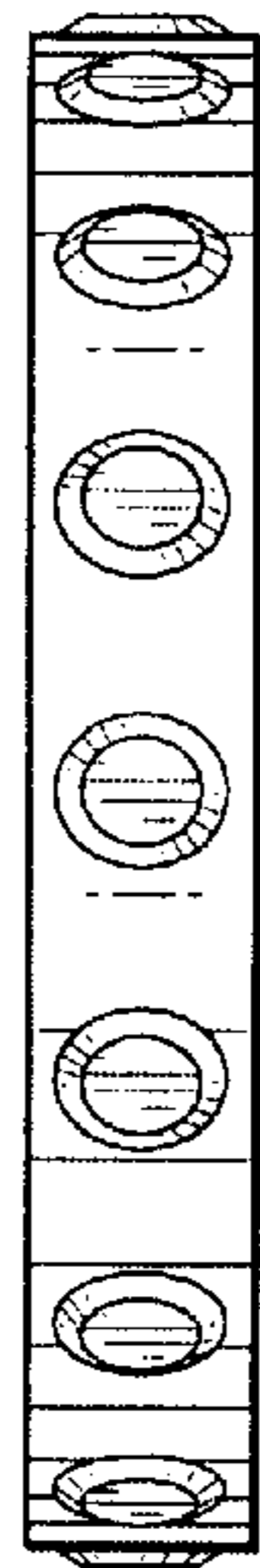

FIG. 3

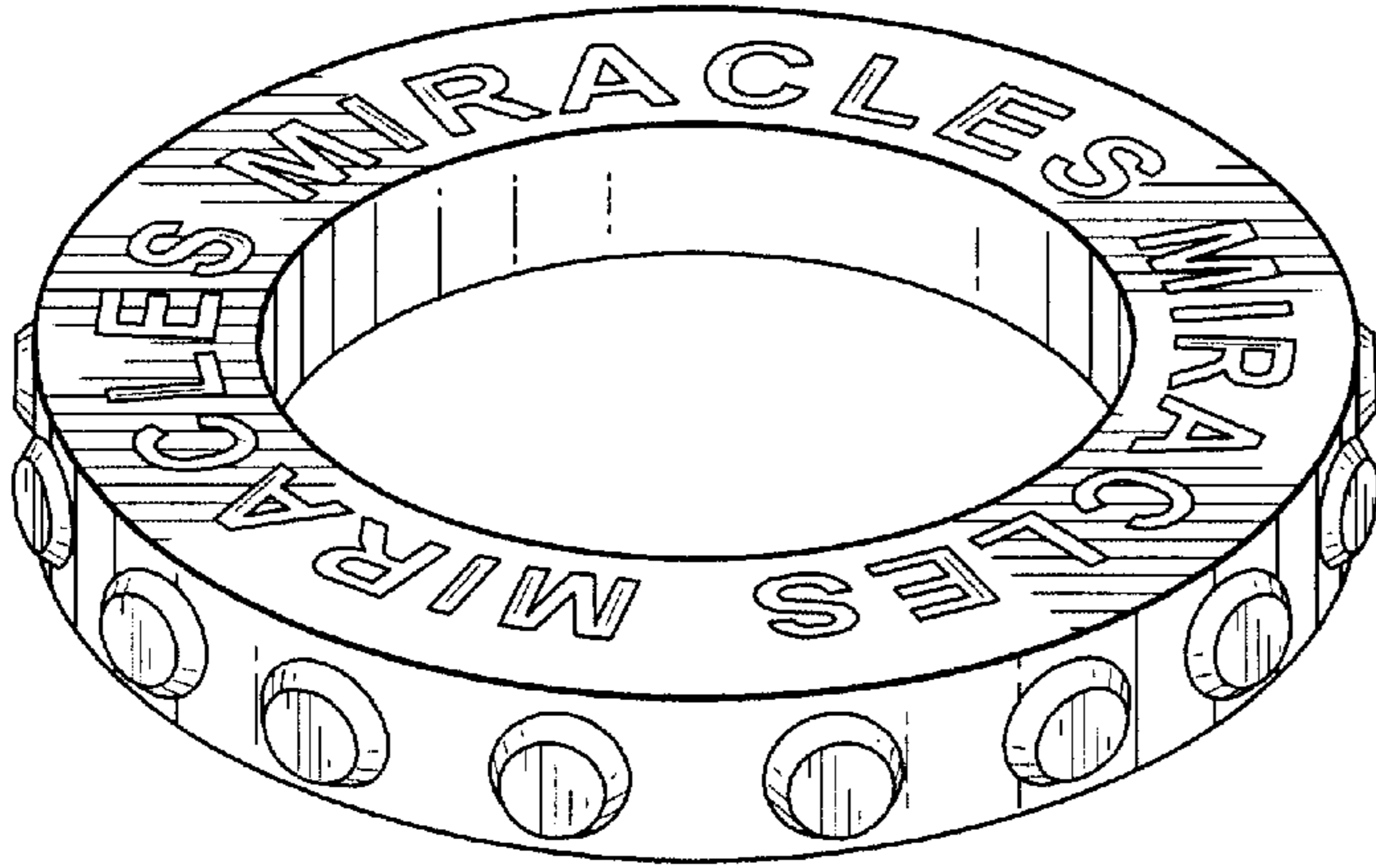

FIG. 4



FIG. 5

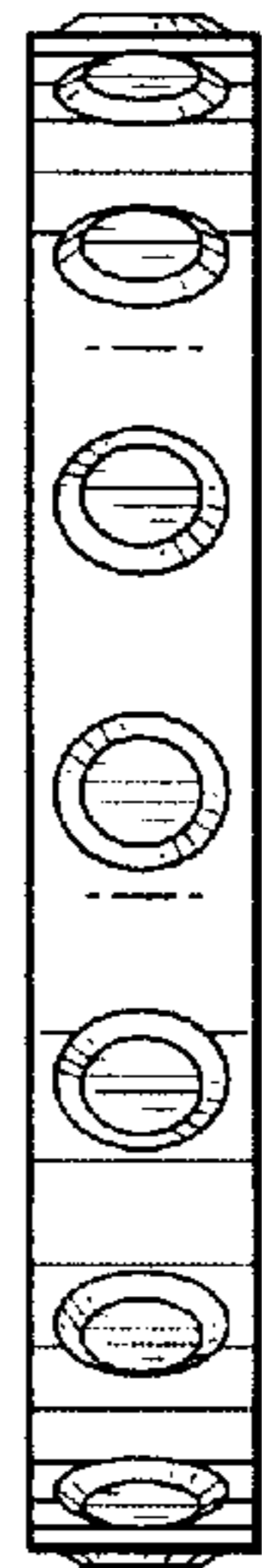

FIG. 6

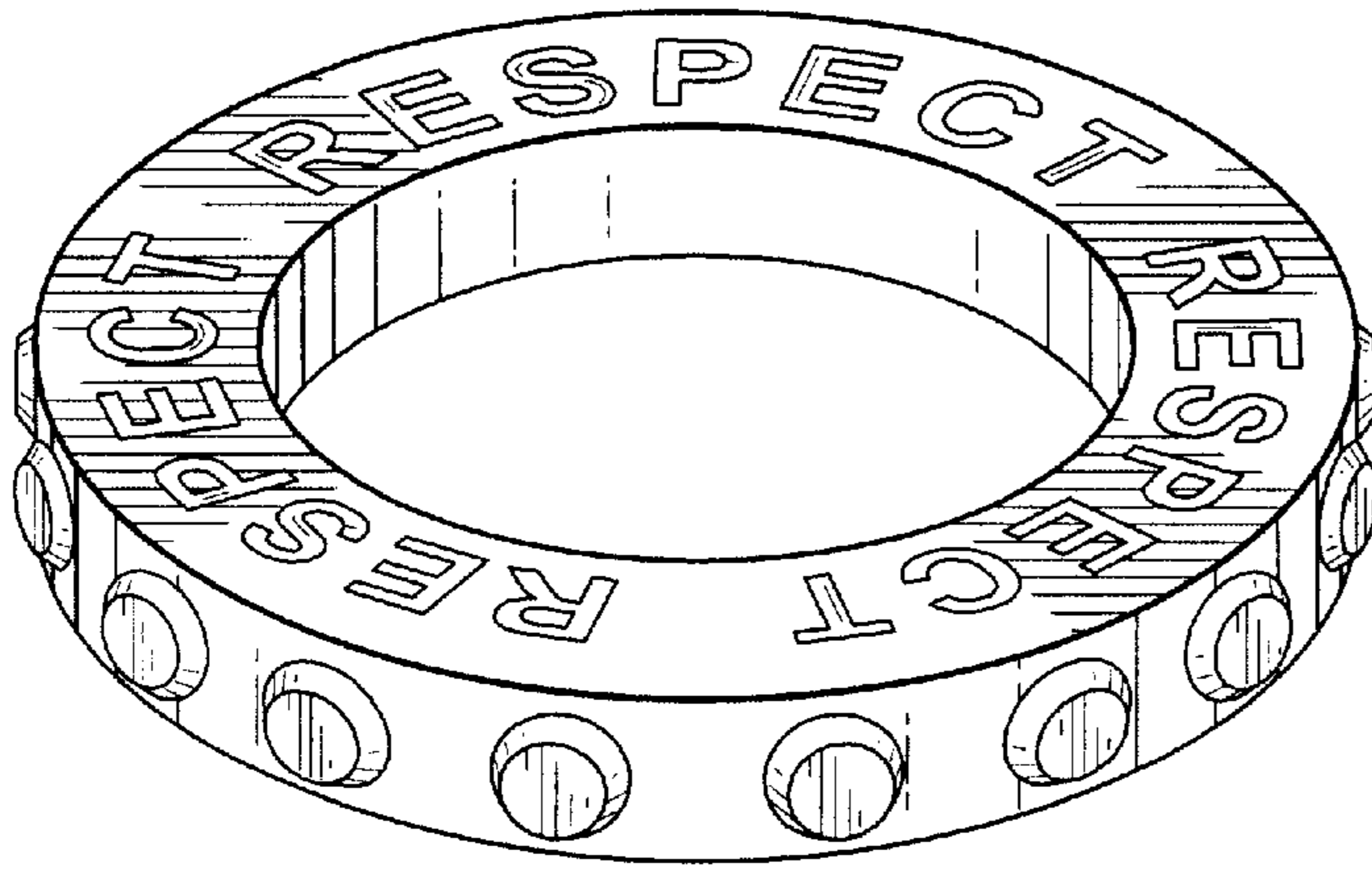

FIG. 7

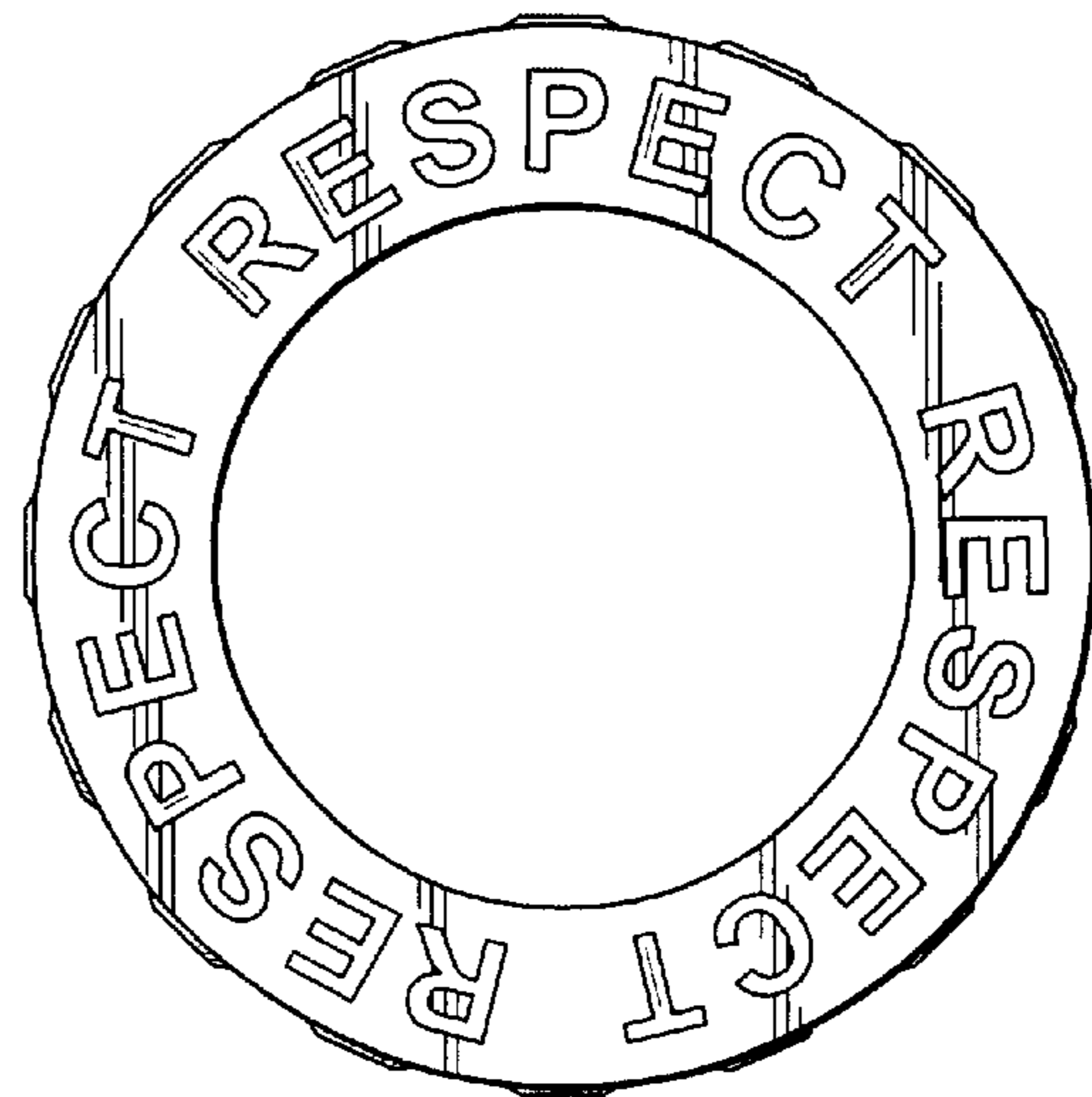

FIG. 8

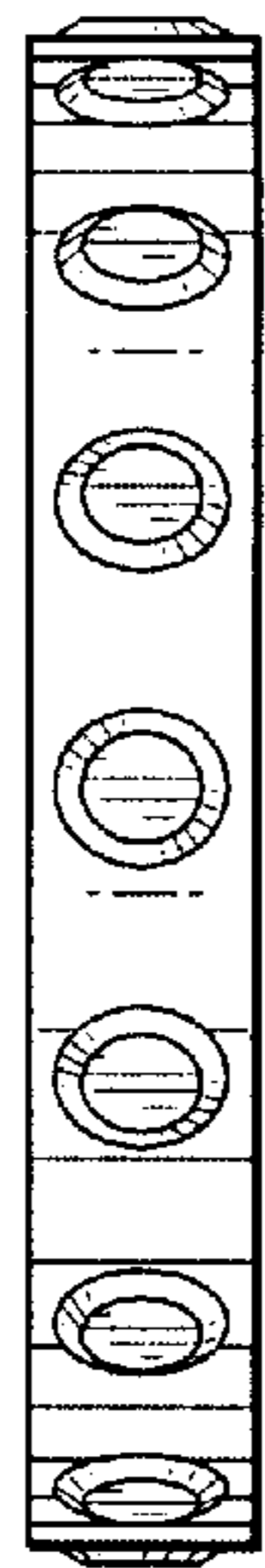

FIG. 9

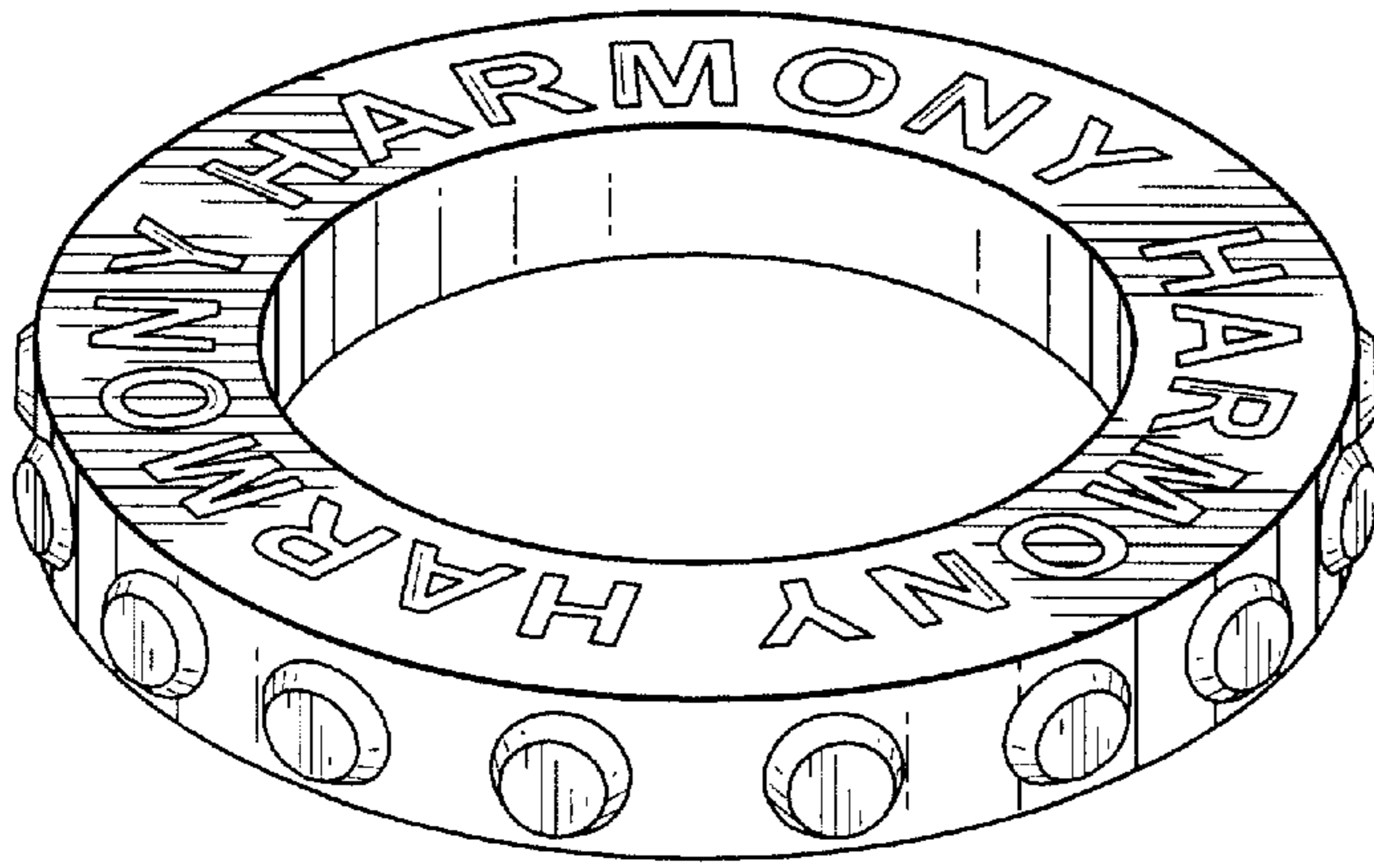

FIG. 10

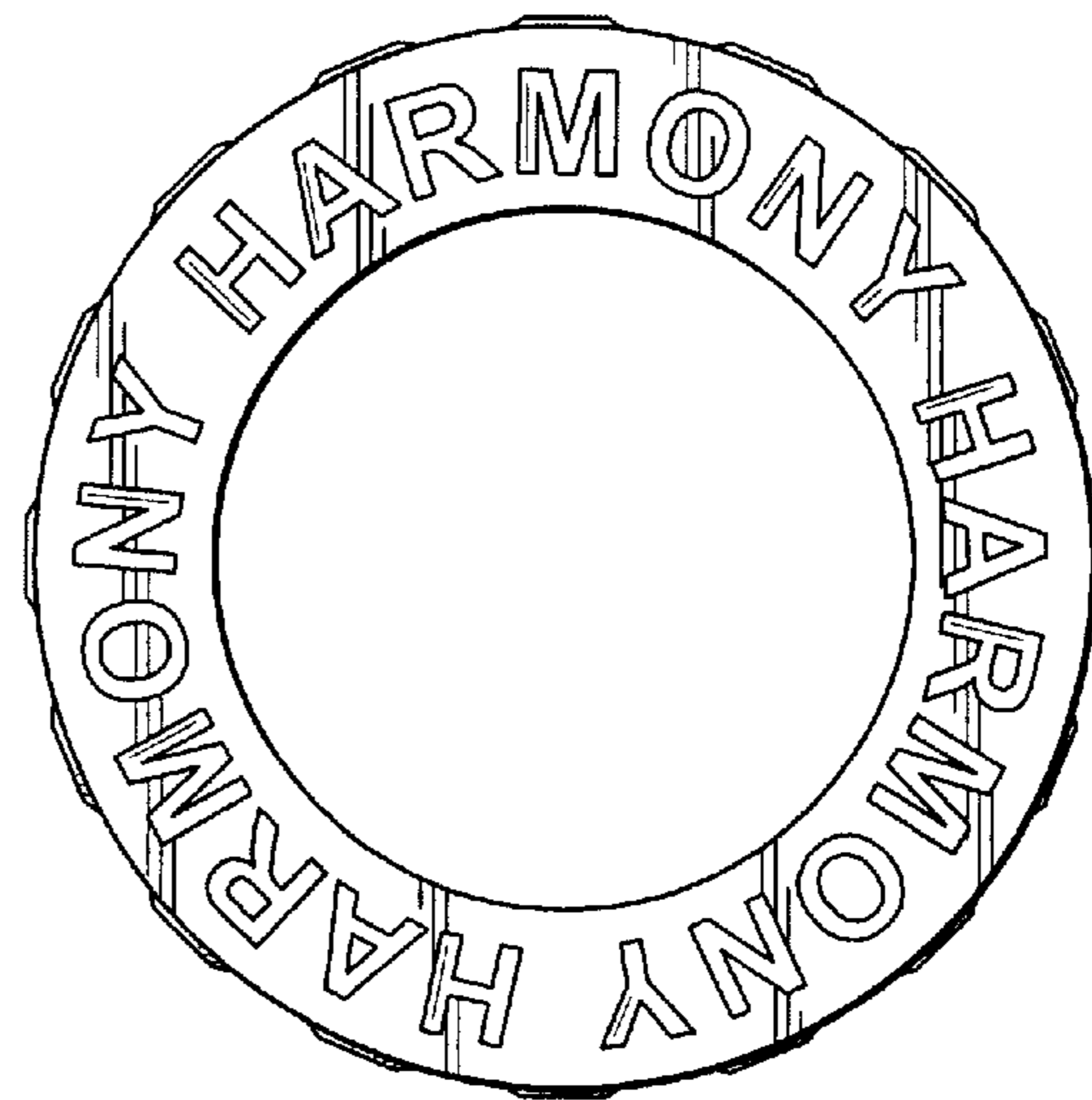

FIG. 11



FIG. 12

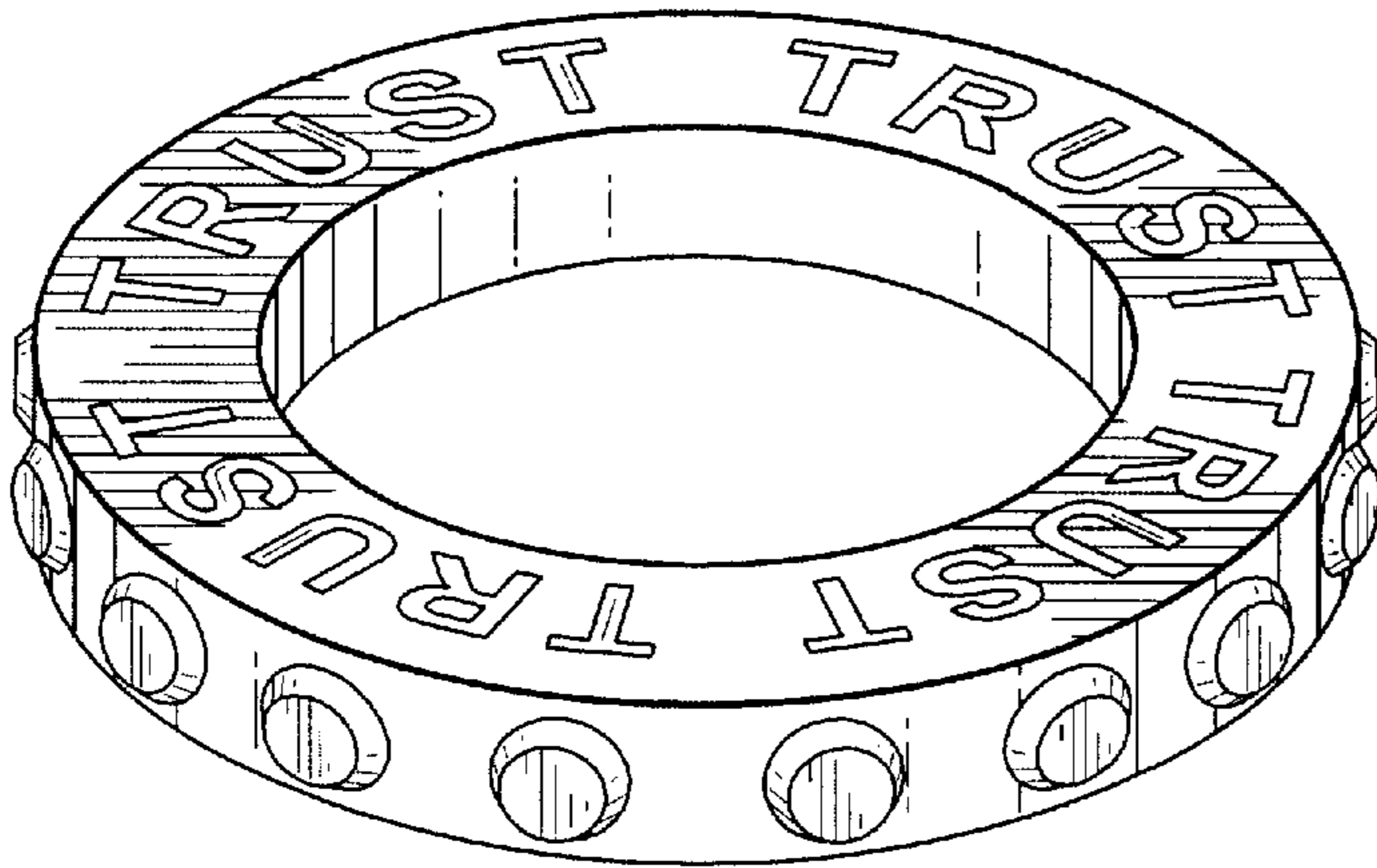

FIG. 13

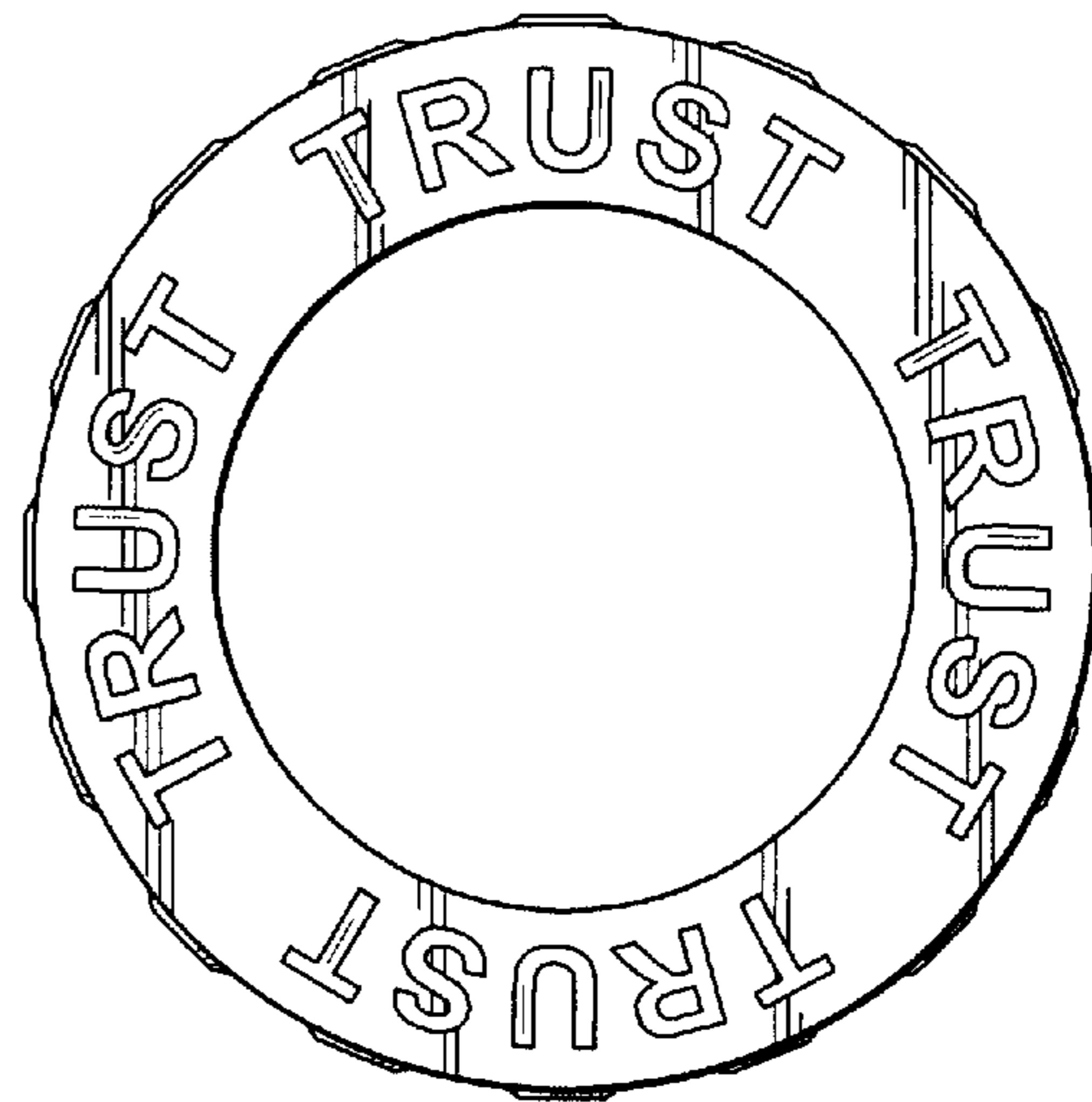

FIG. 14



FIG. 15

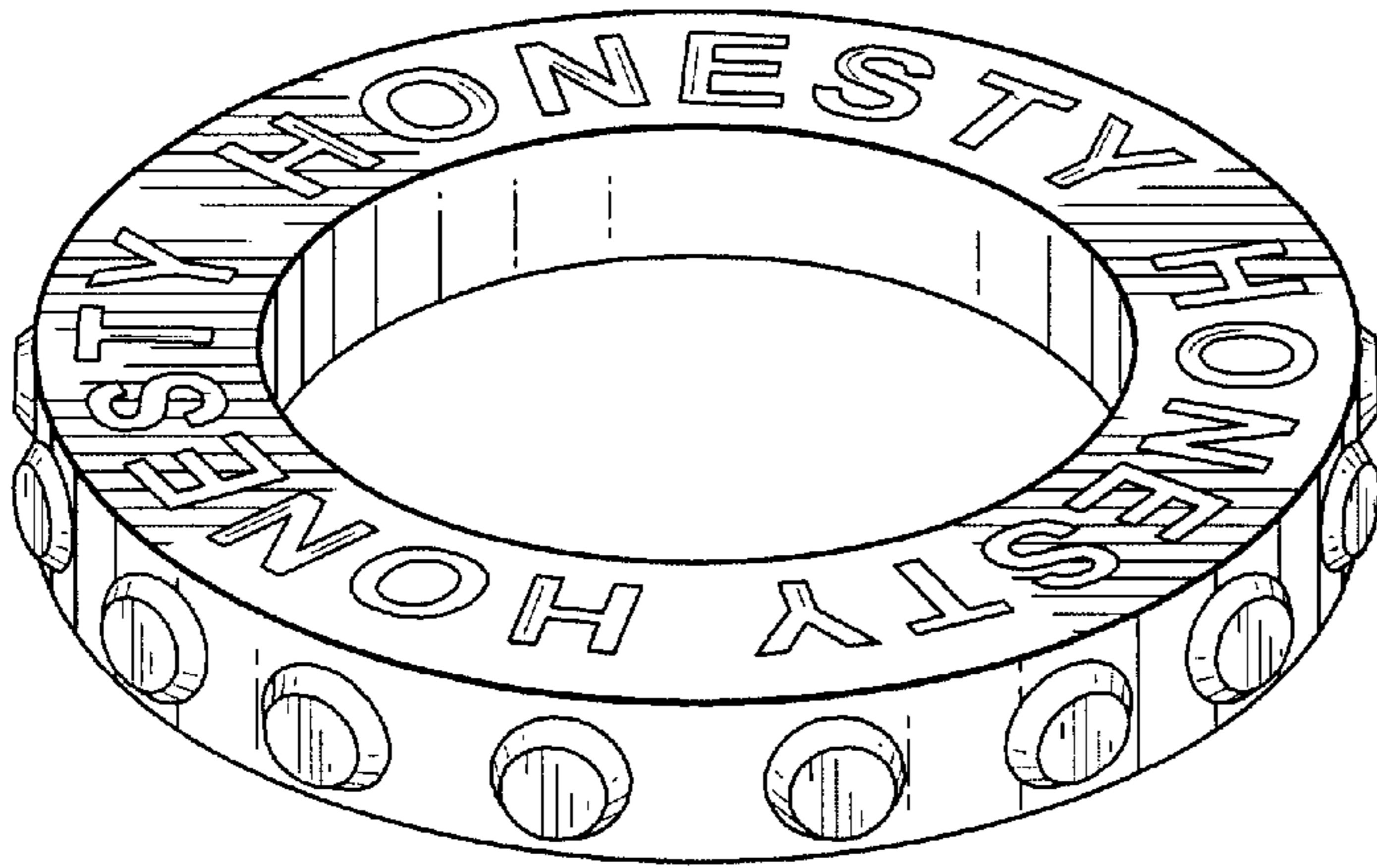

FIG. 16



FIG. 17

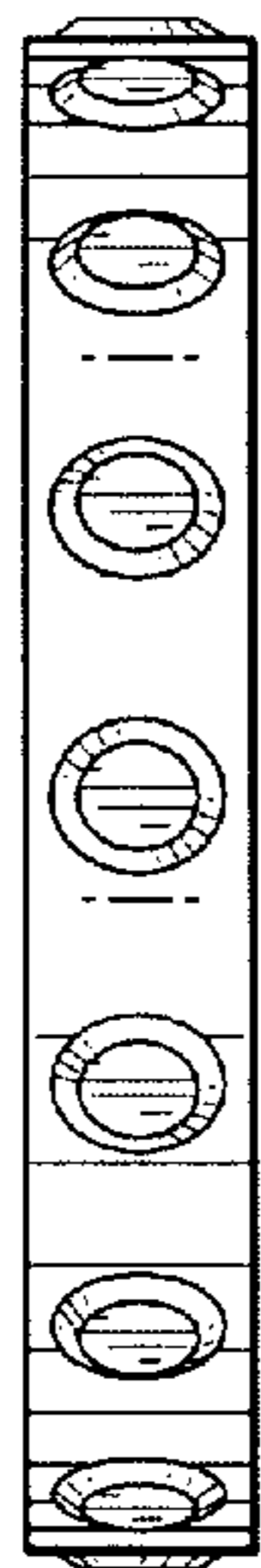

FIG. 18

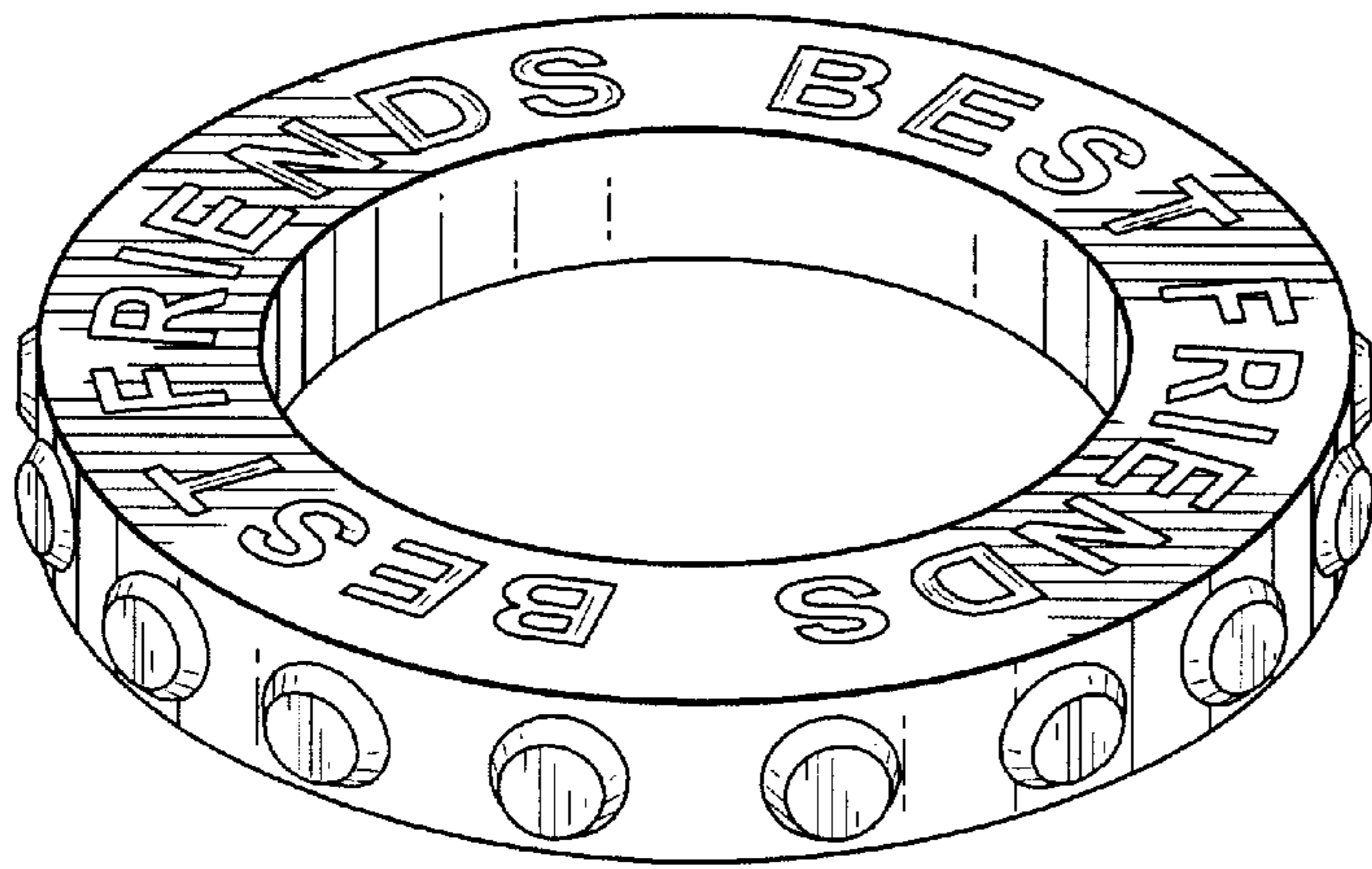

FIG. 19

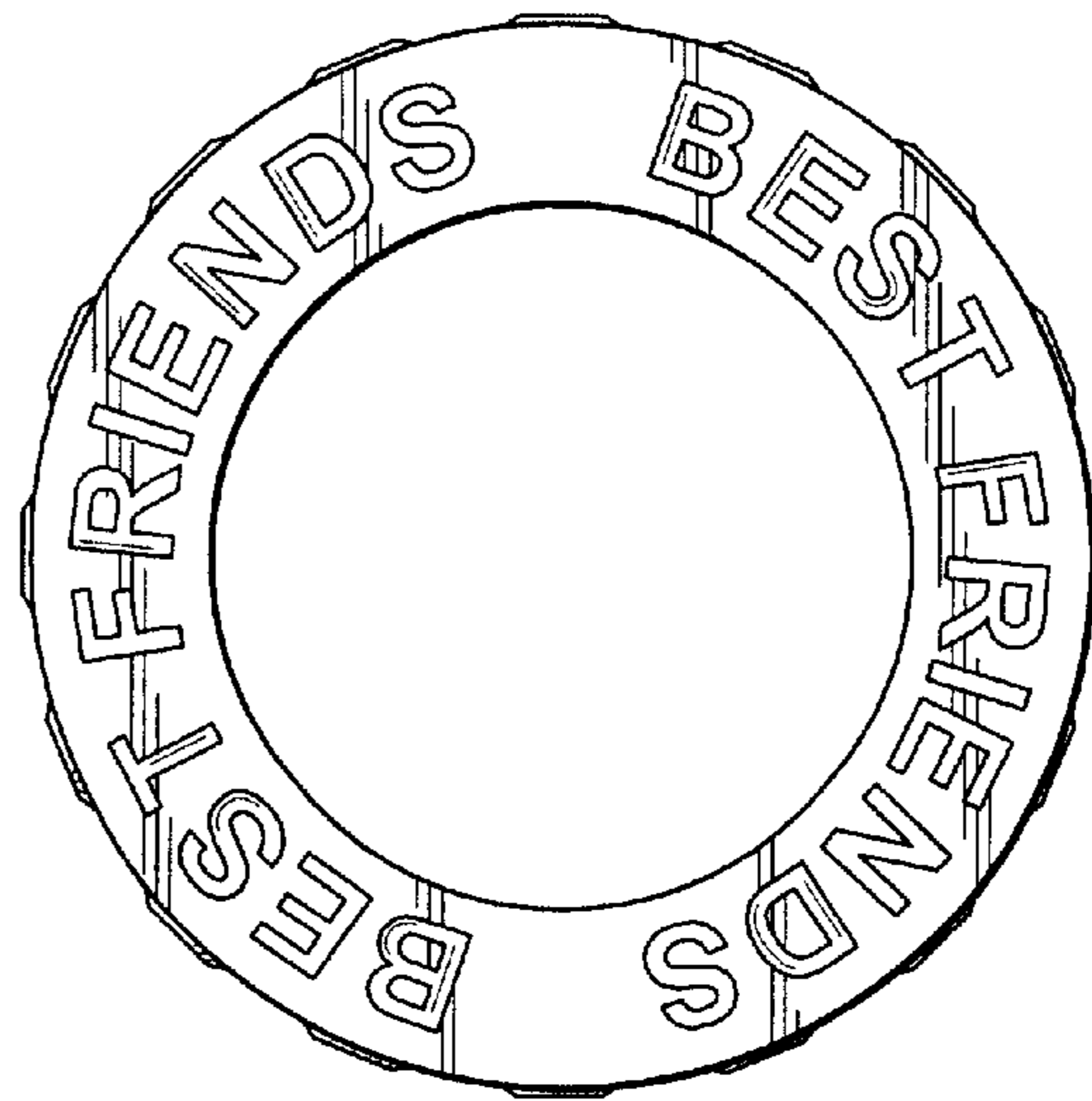

FIG. 20

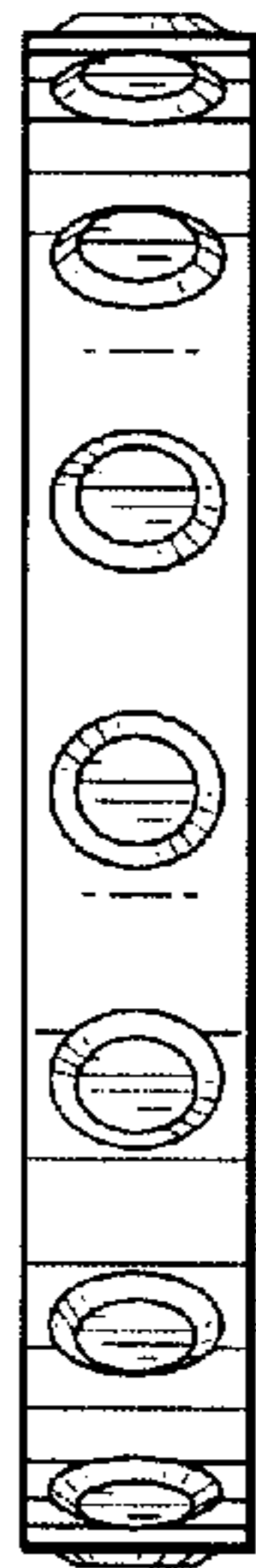

FIG. 21

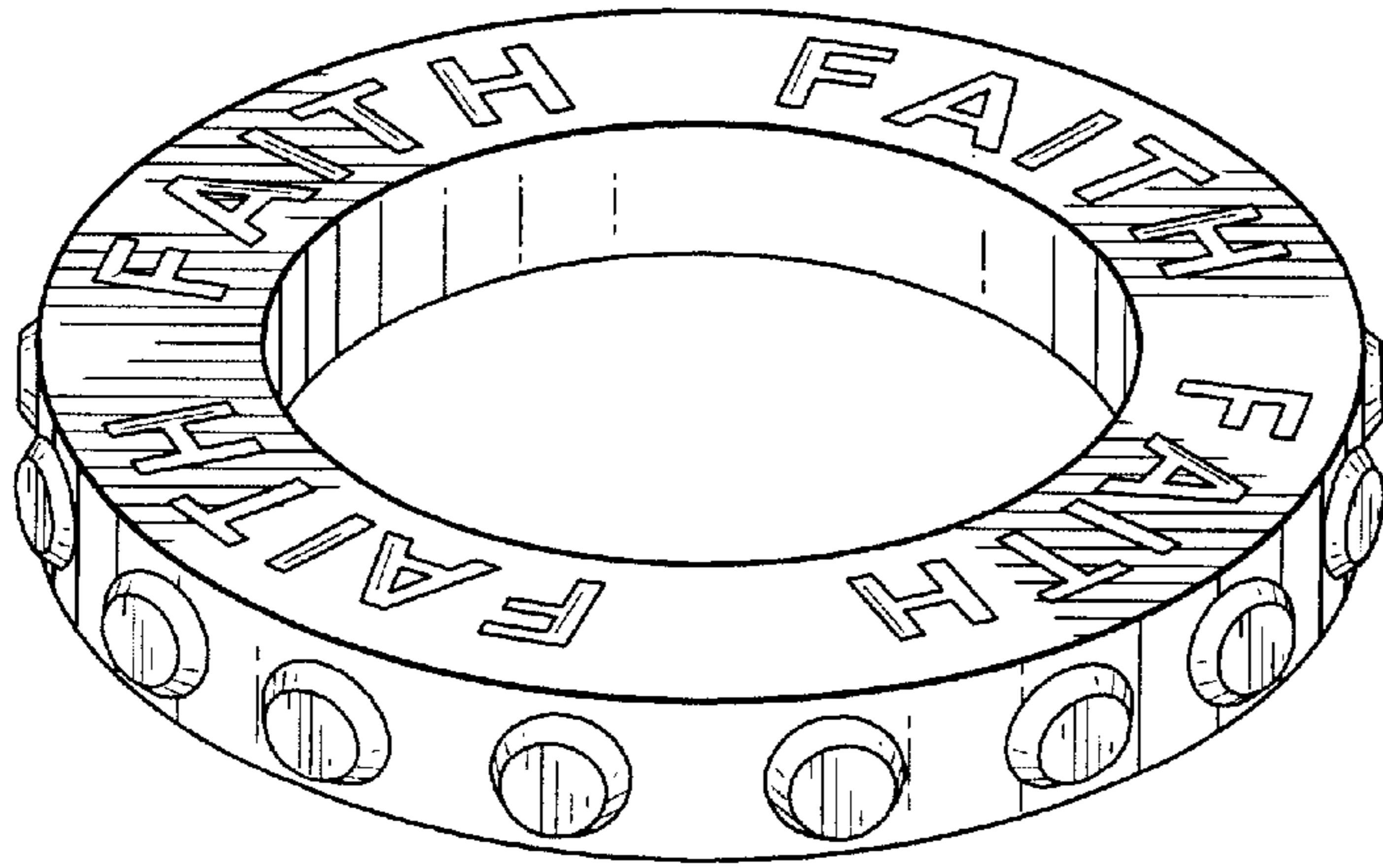

FIG. 22

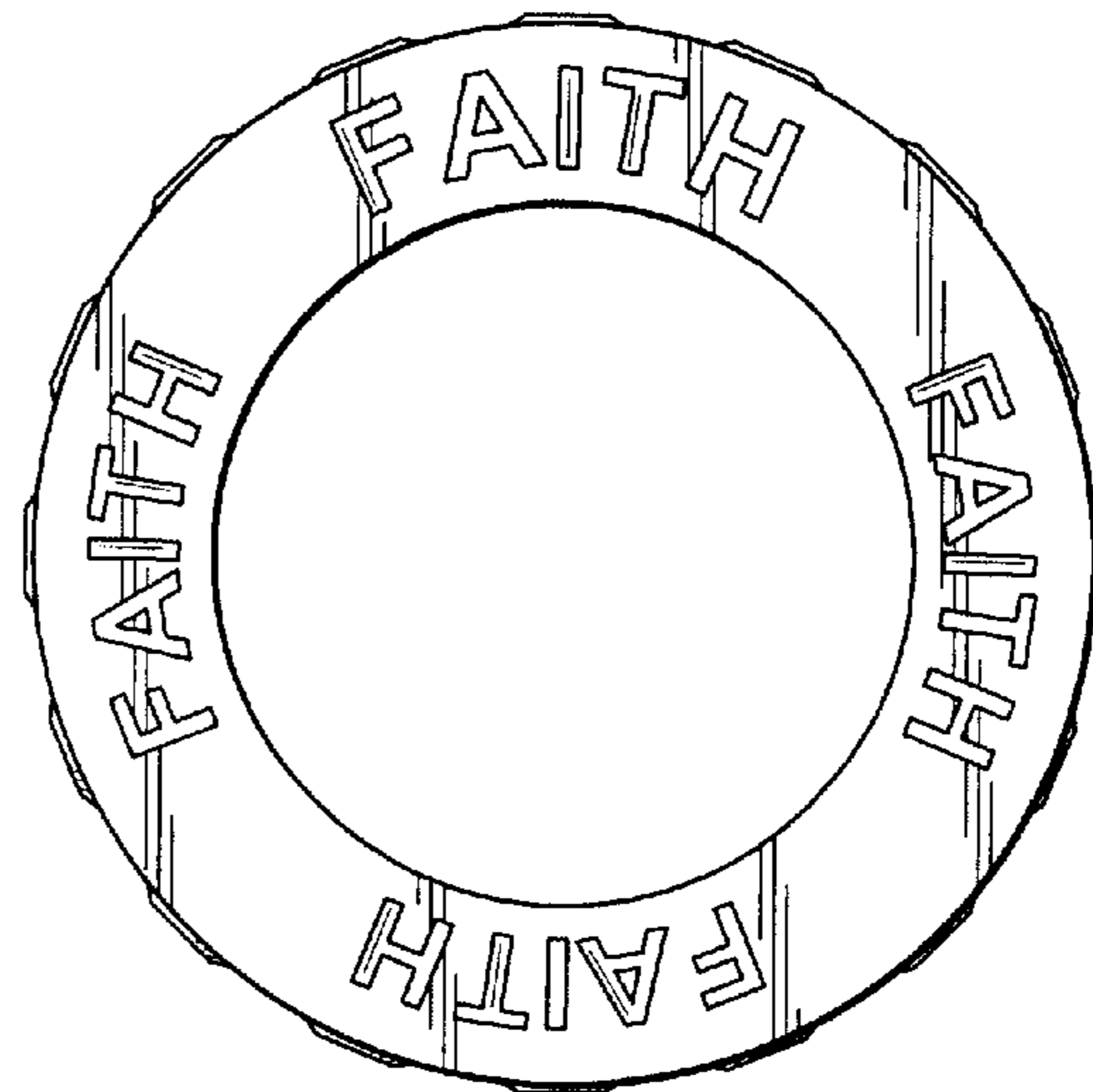

FIG. 23

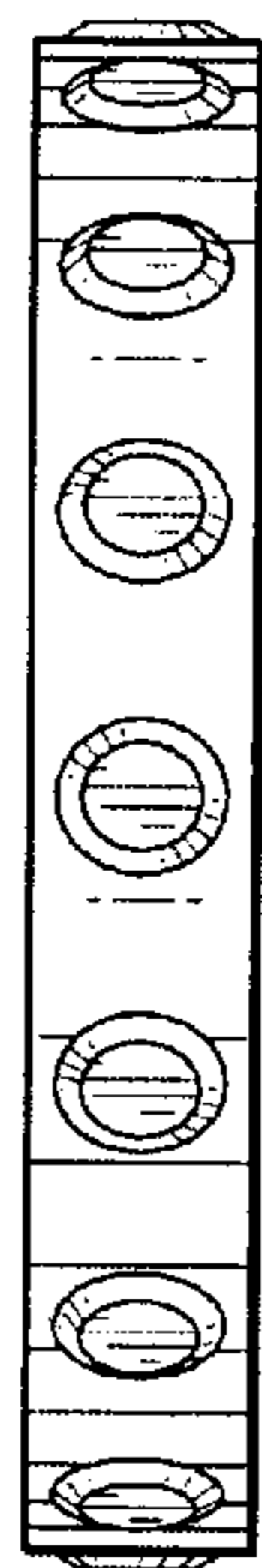

FIG. 24

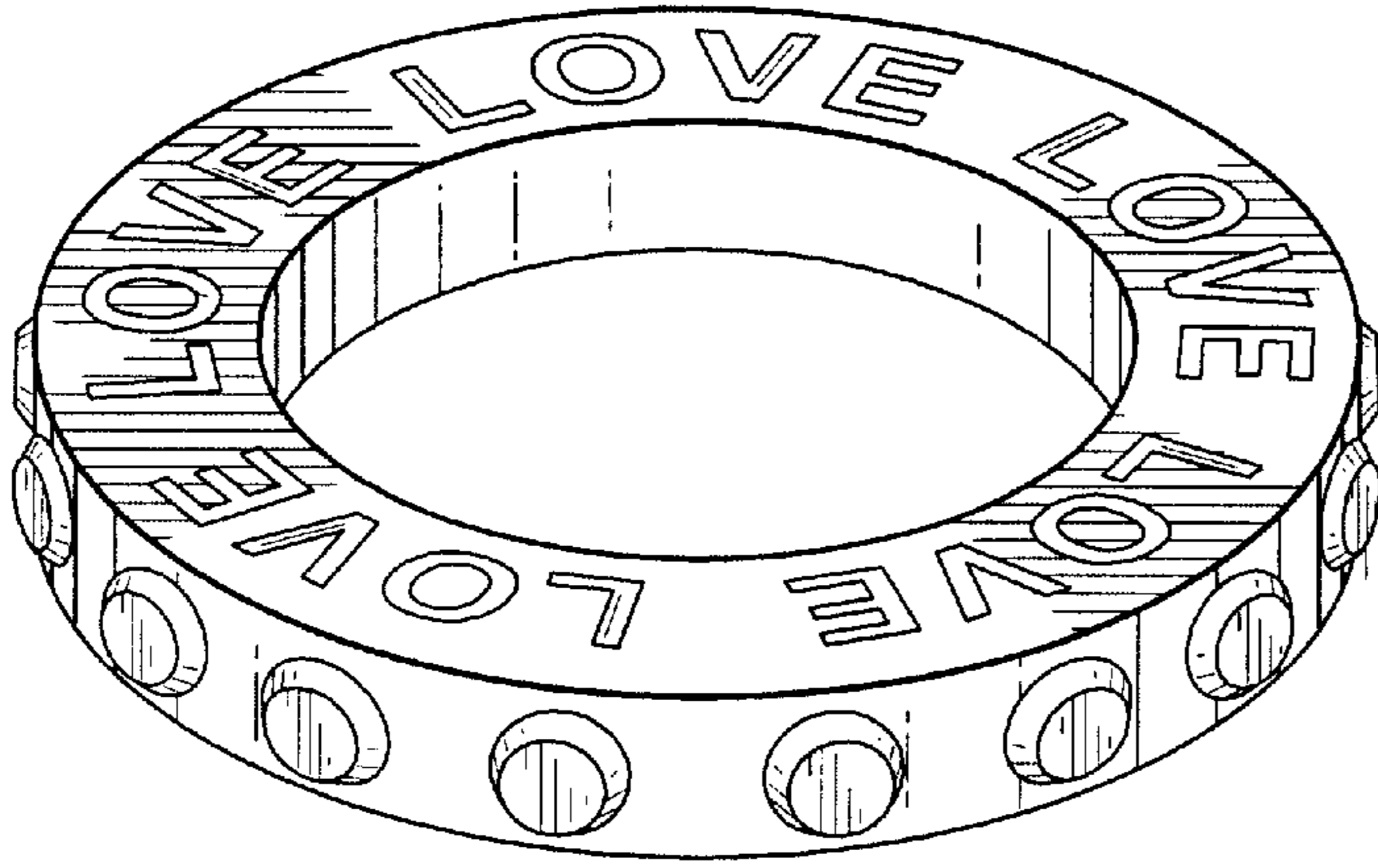

FIG. 25

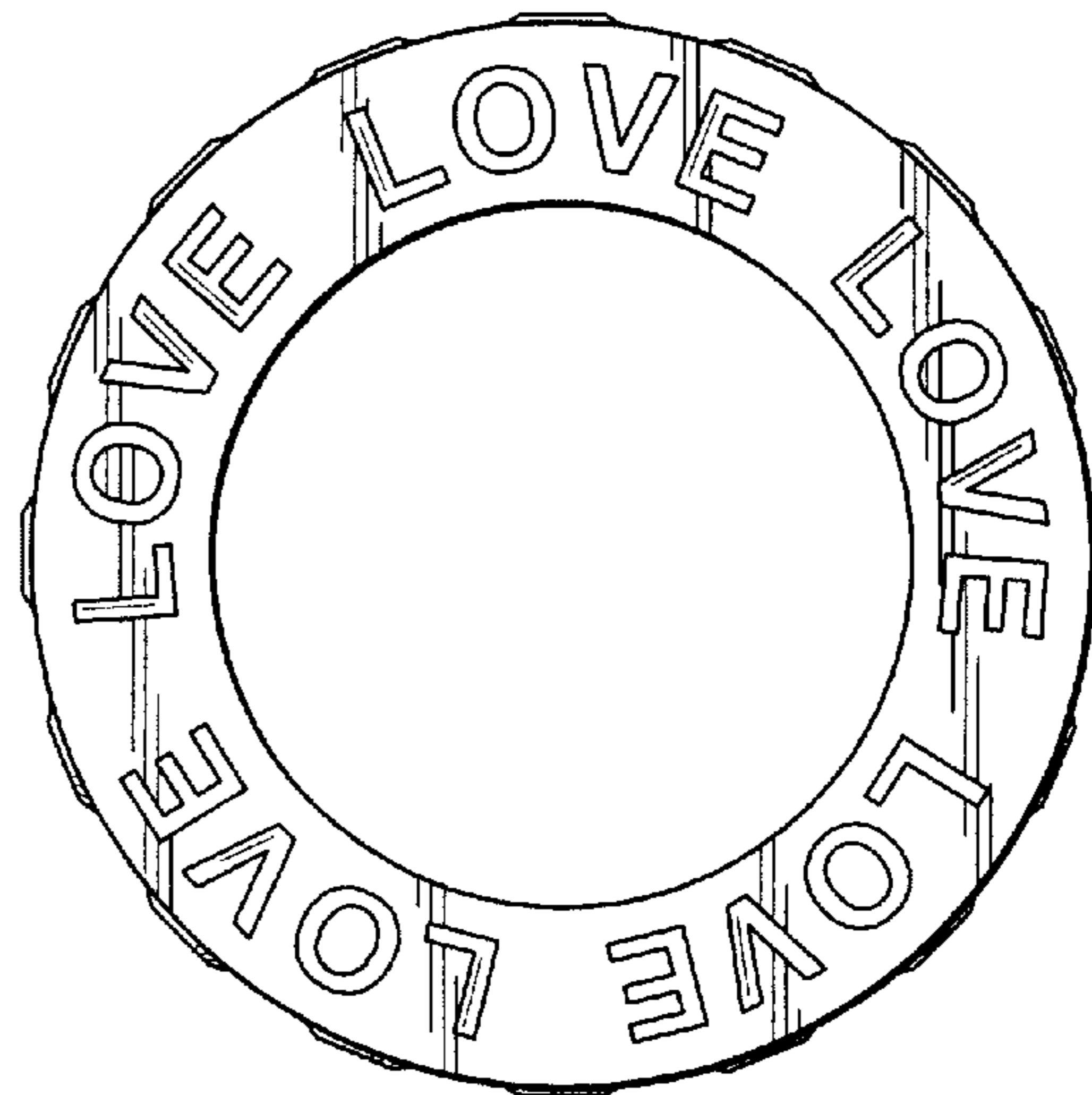

FIG. 26

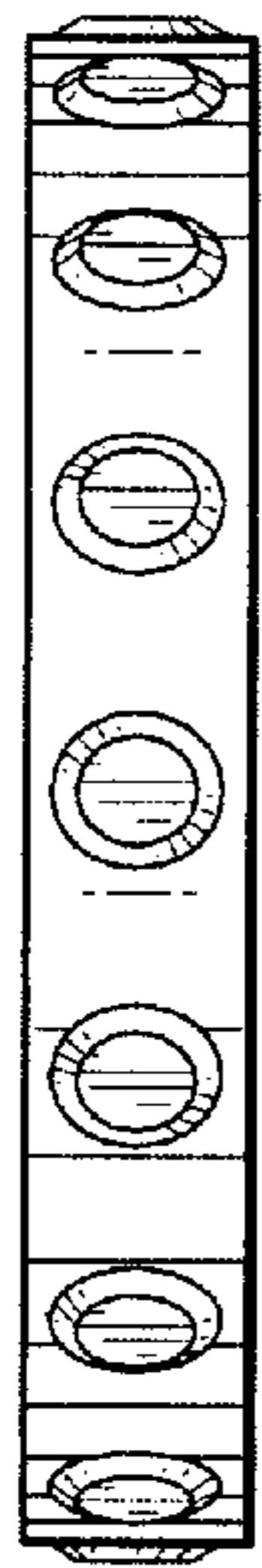

FIG. 27

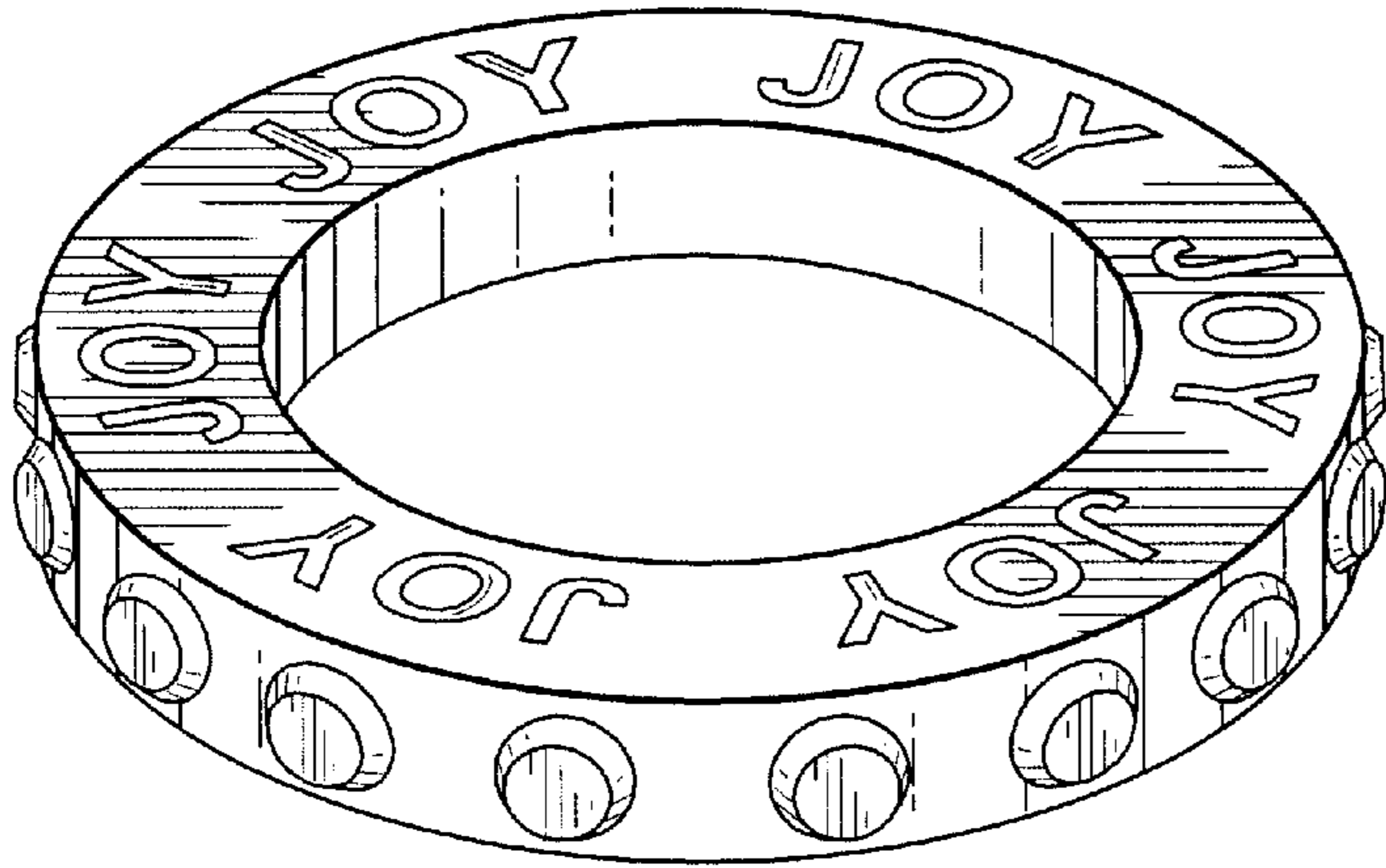

FIG. 28

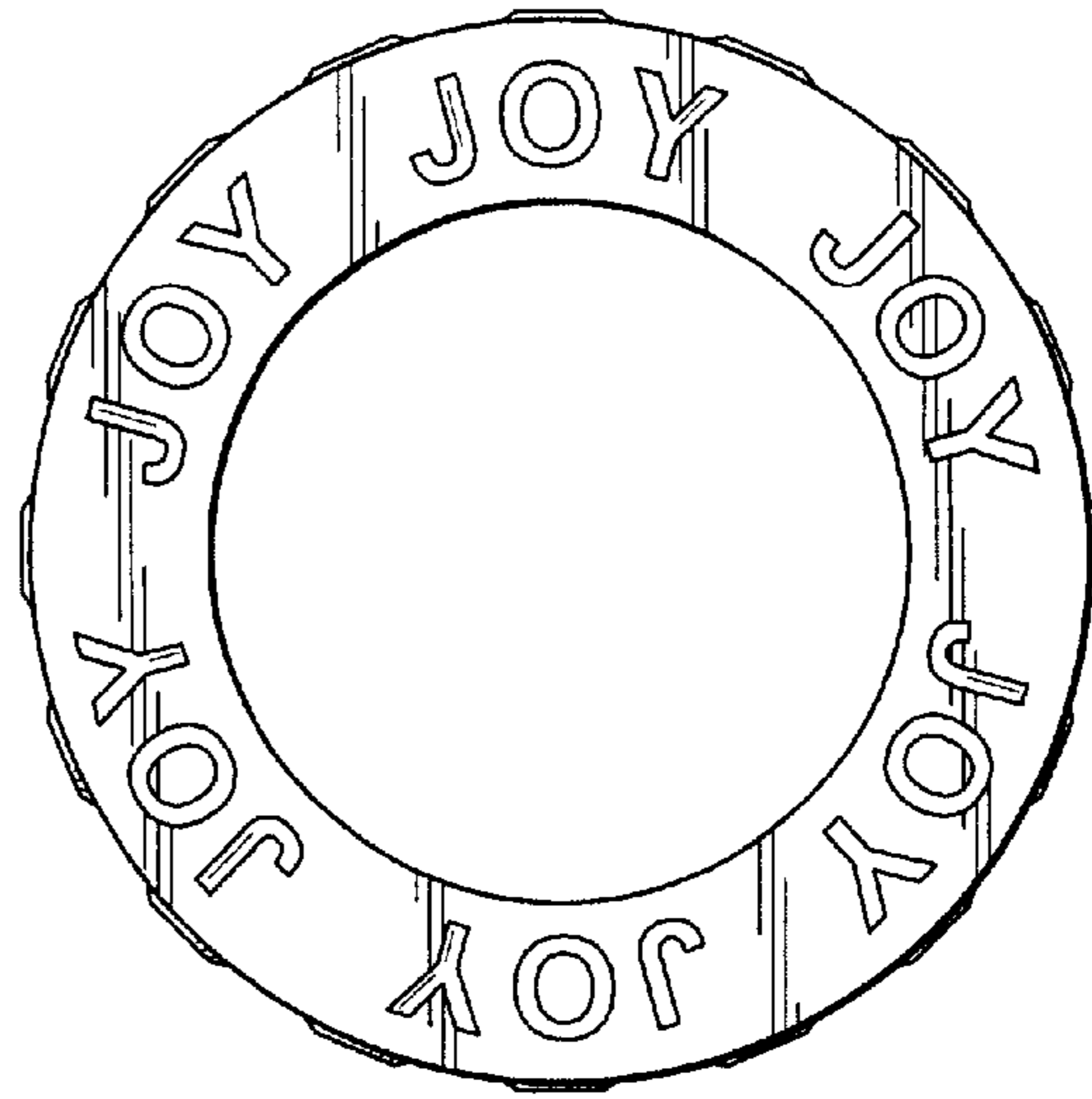

FIG. 29

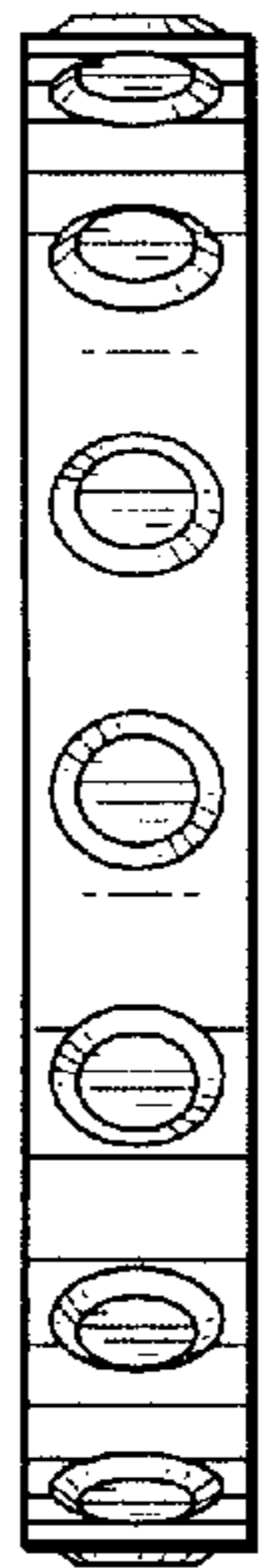

FIG. 30

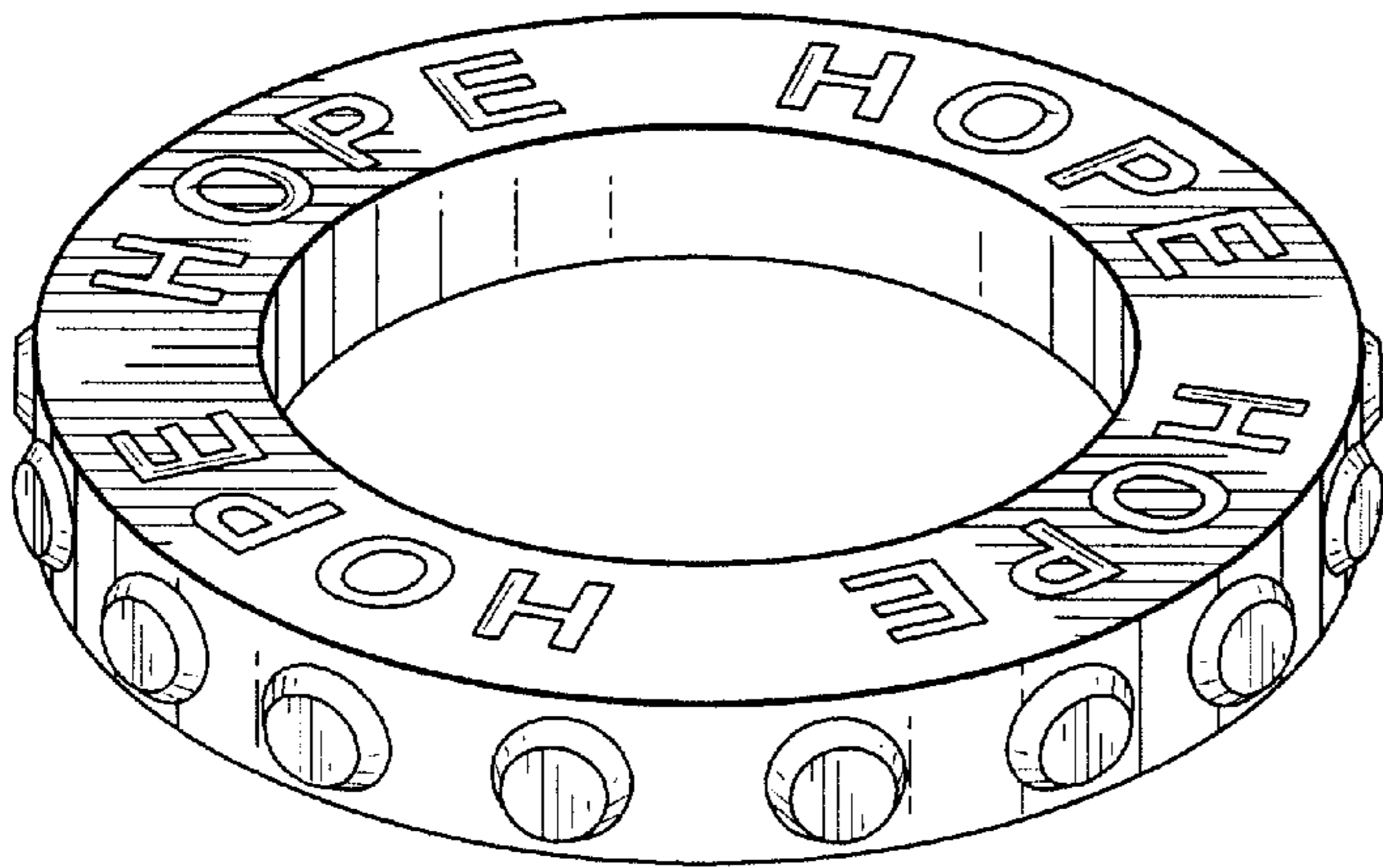

FIG. 31

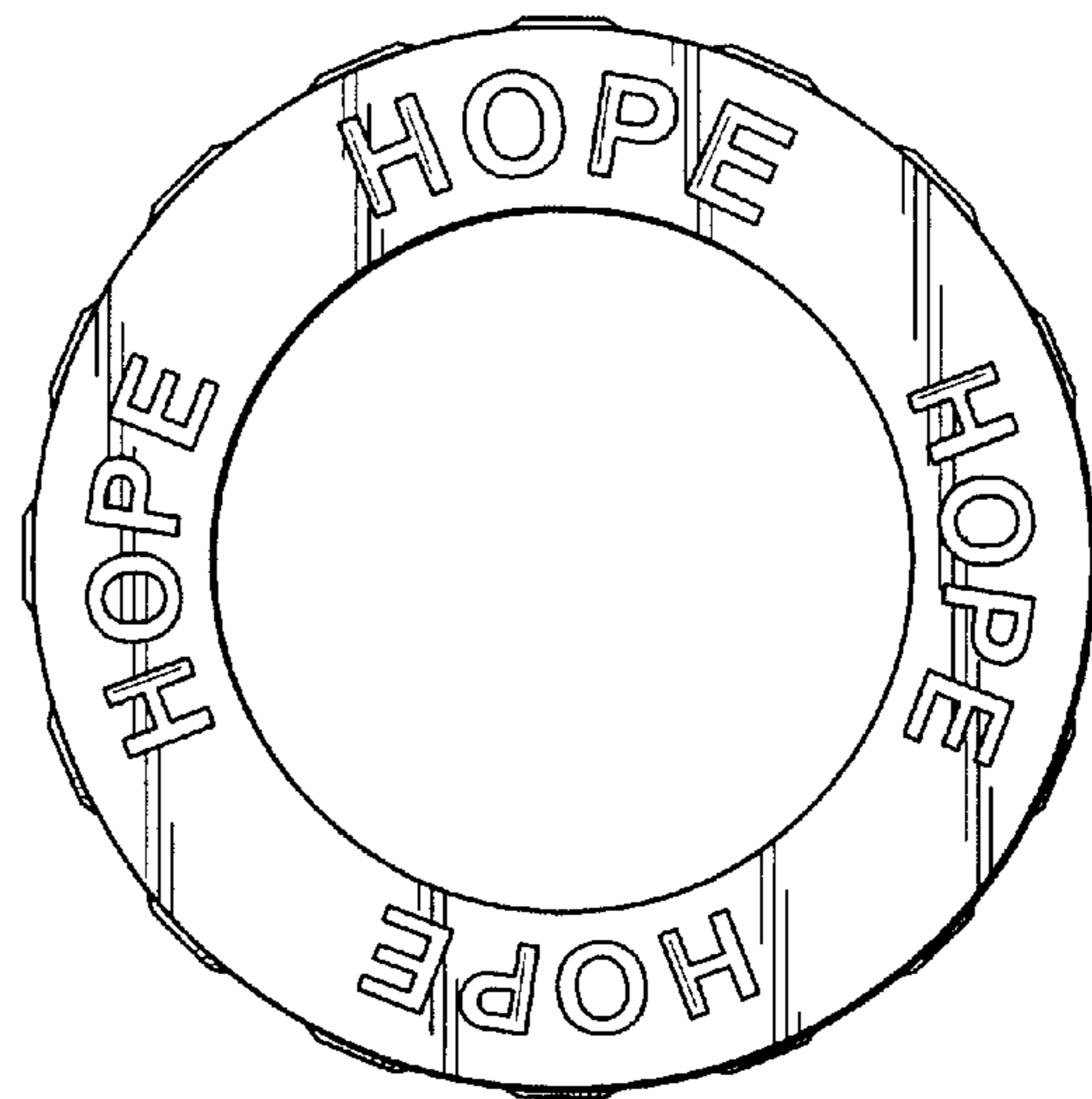

FIG. 32

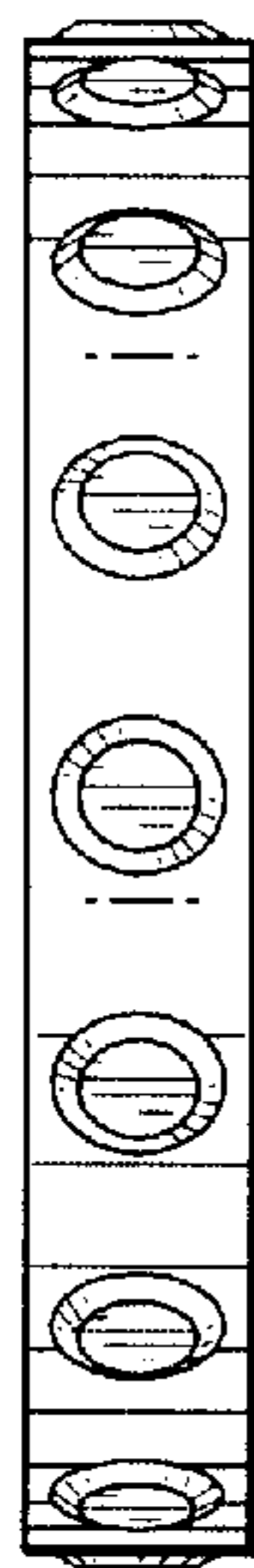

FIG. 33

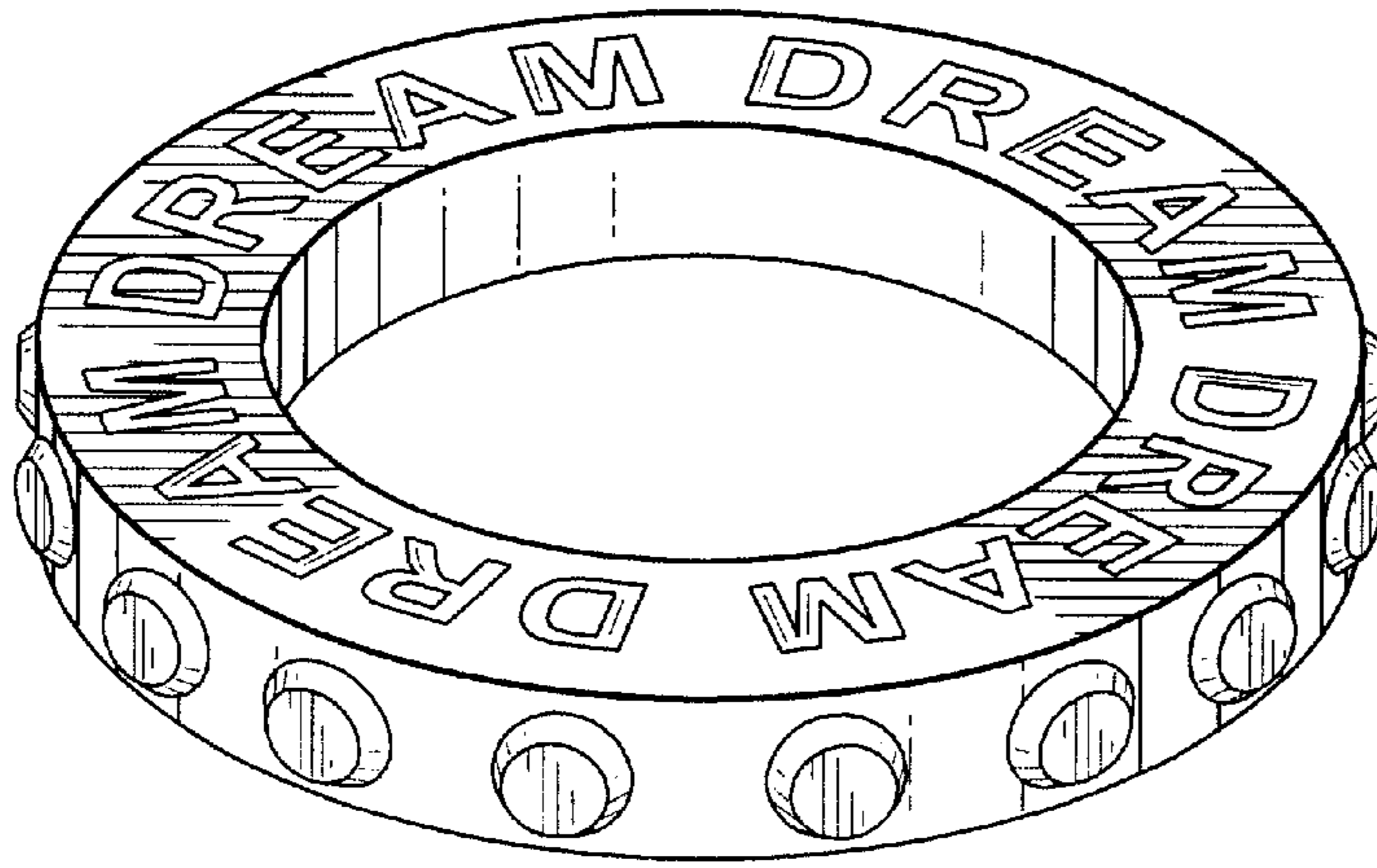

FIG. 34

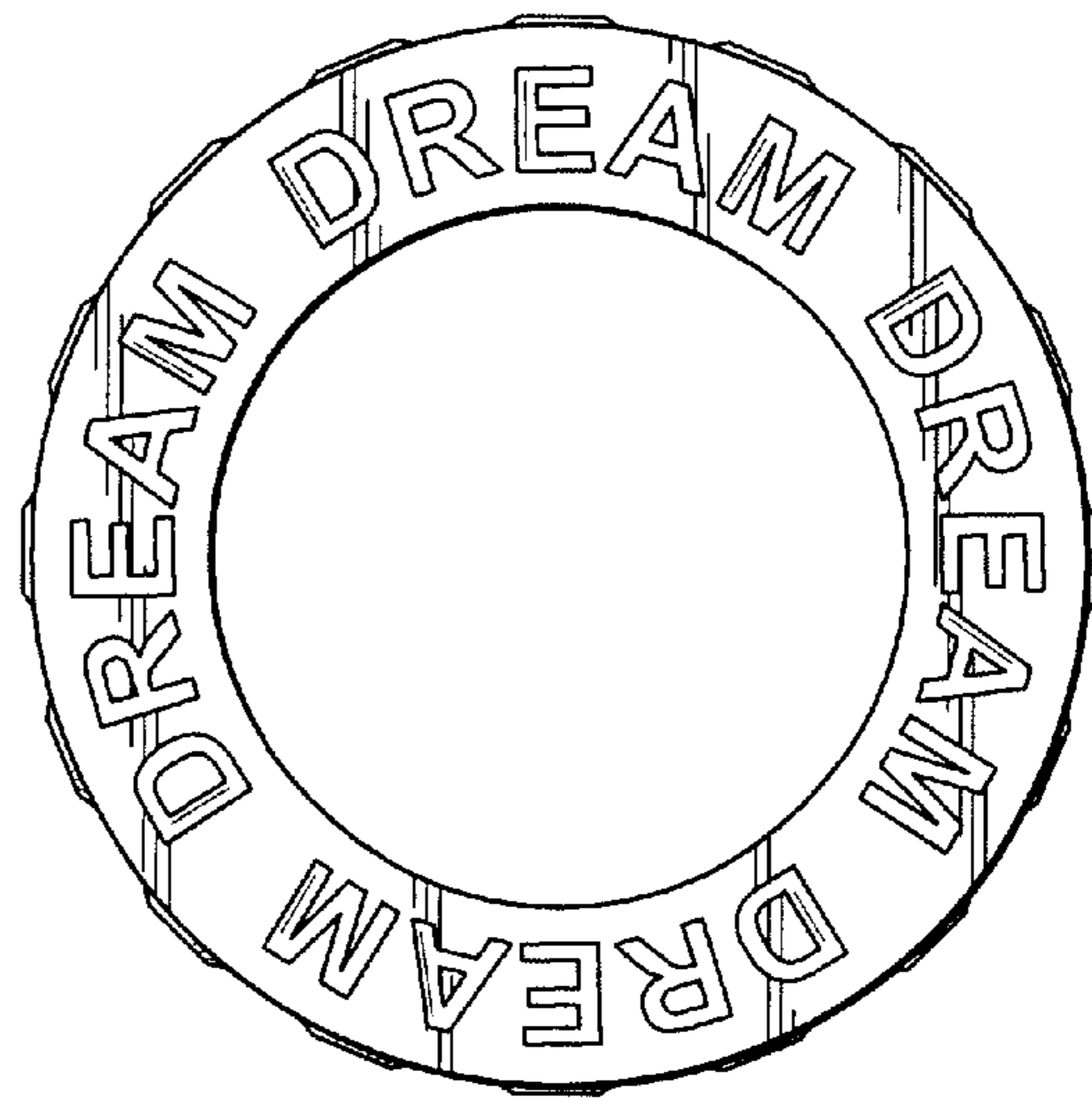

FIG. 35

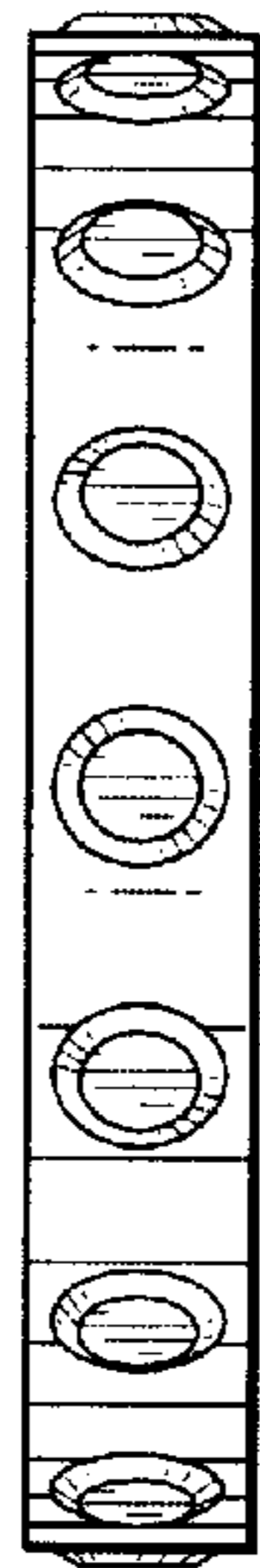

FIG. 36

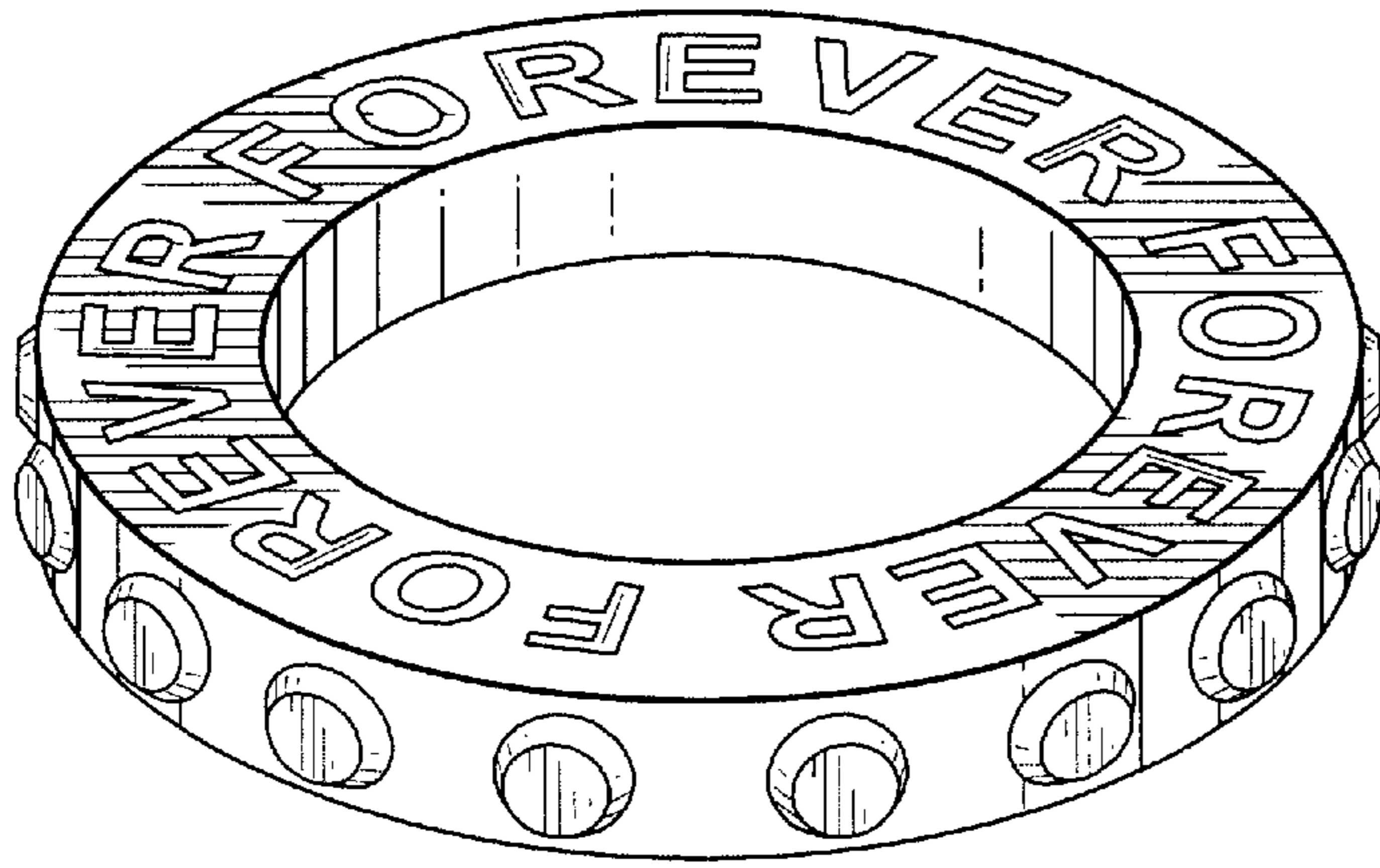

FIG. 37

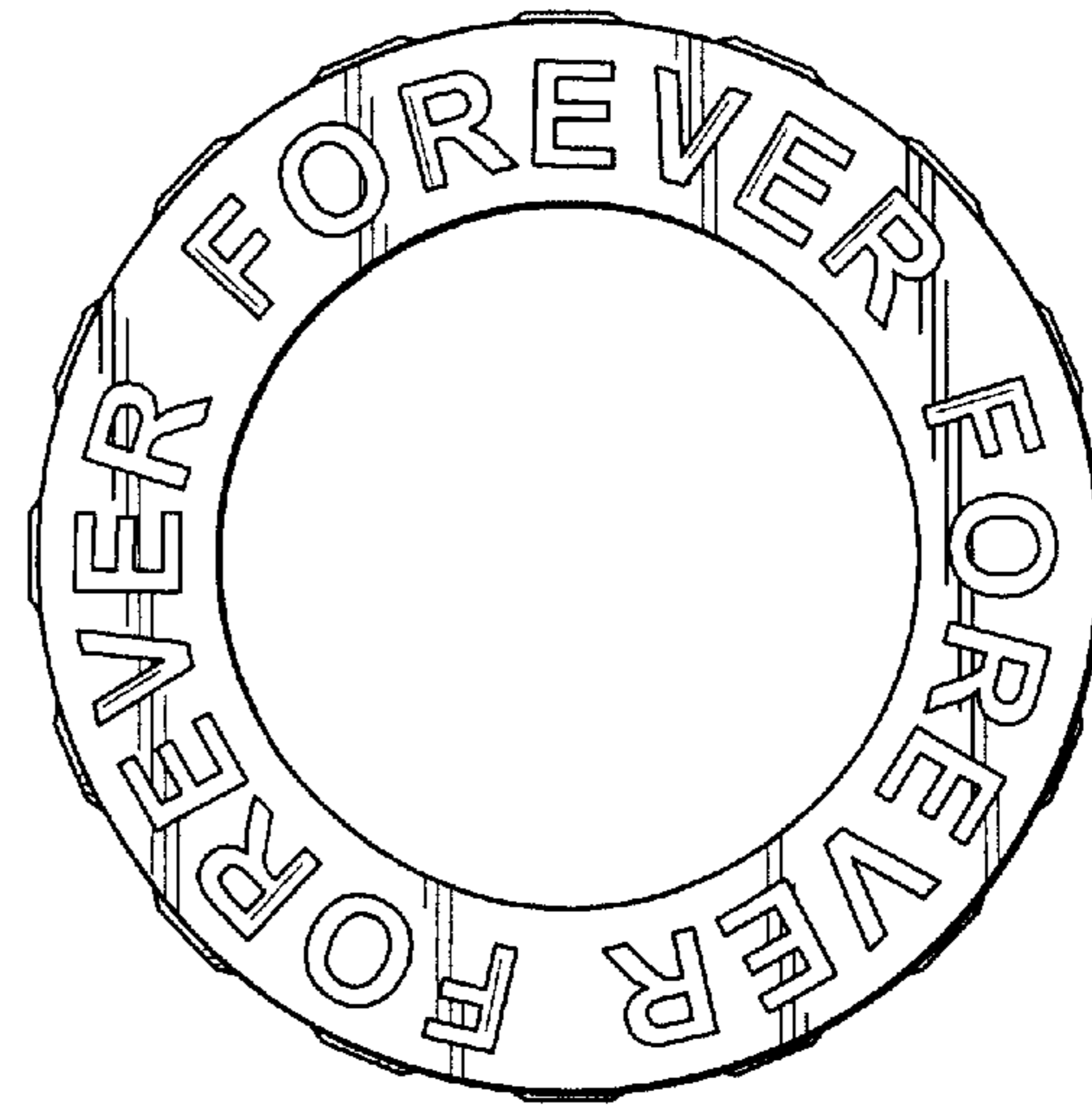

FIG. 38

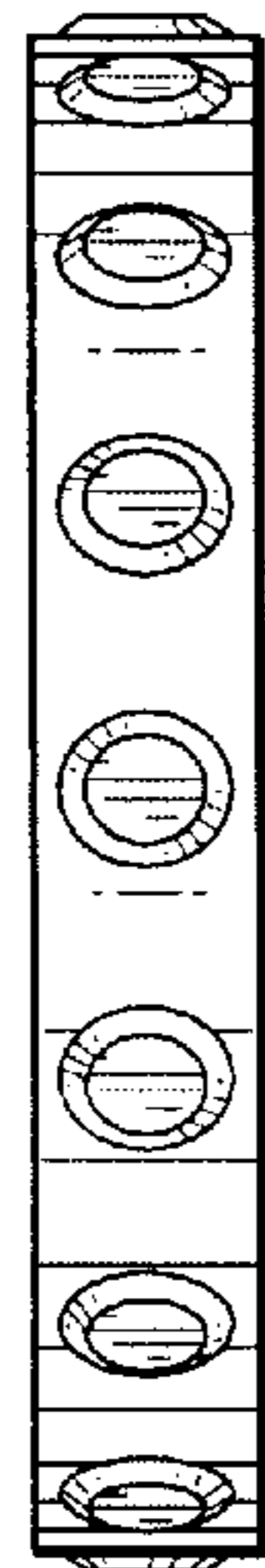

FIG. 39

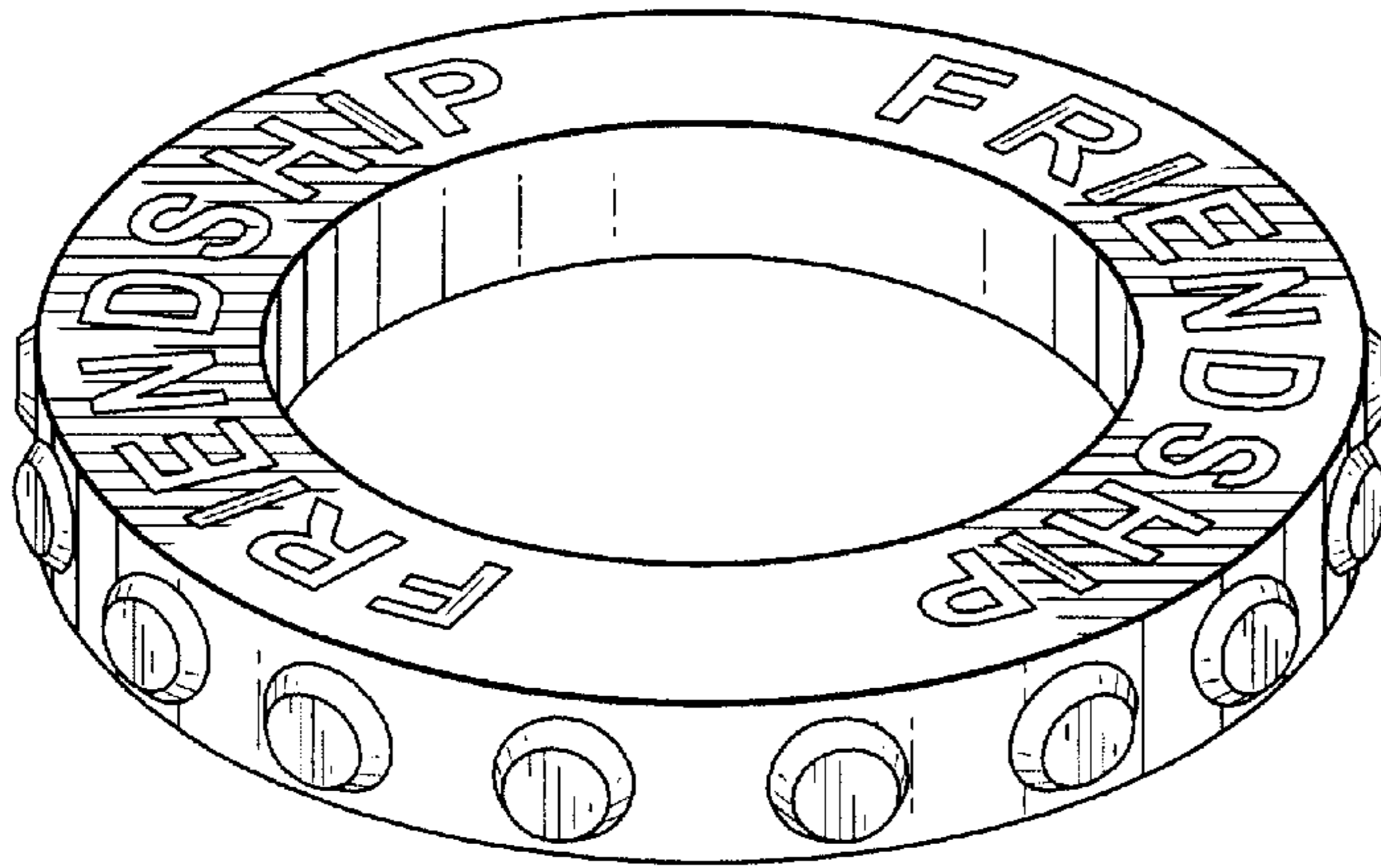

FIG. 40

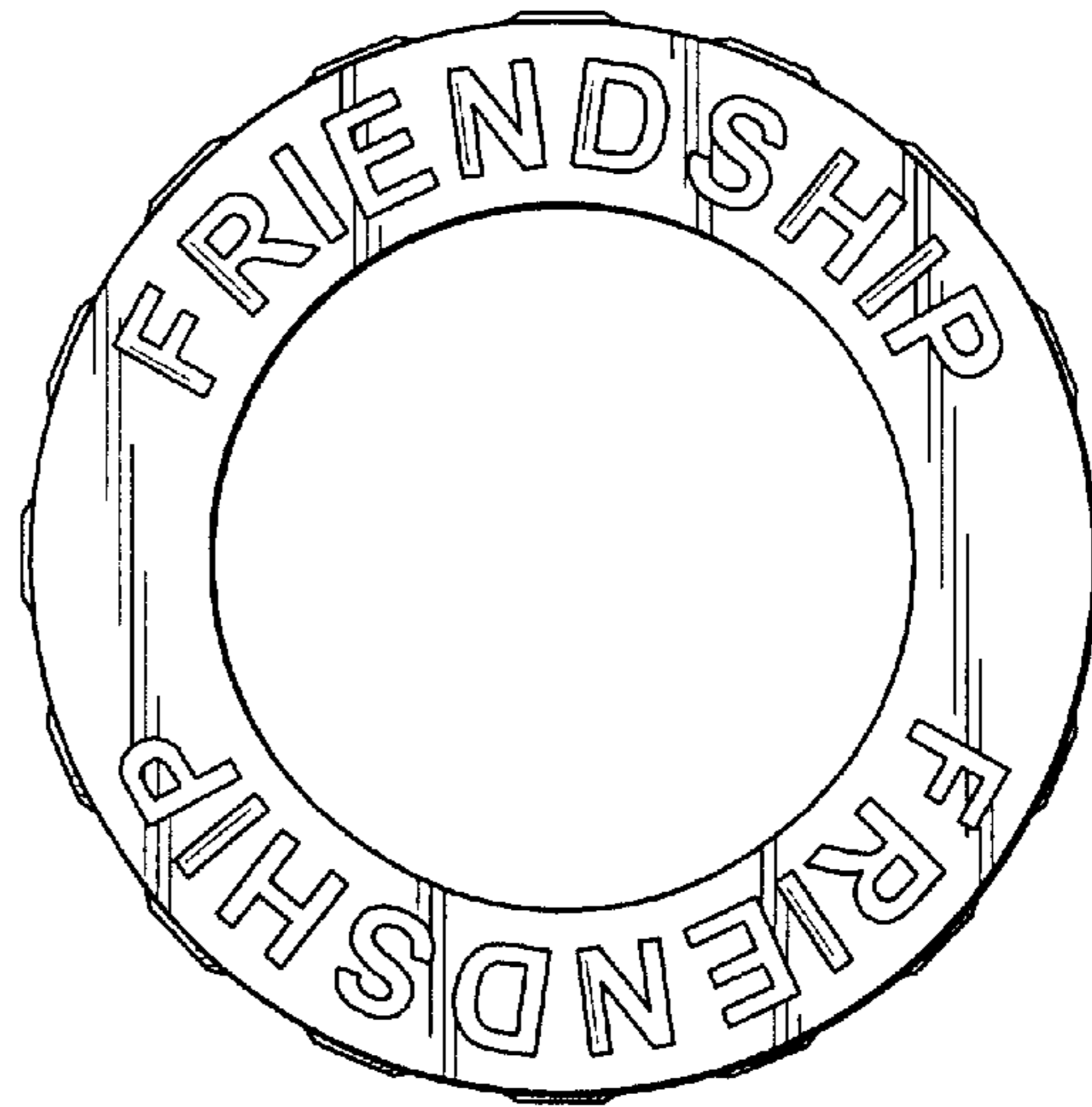

FIG. 41

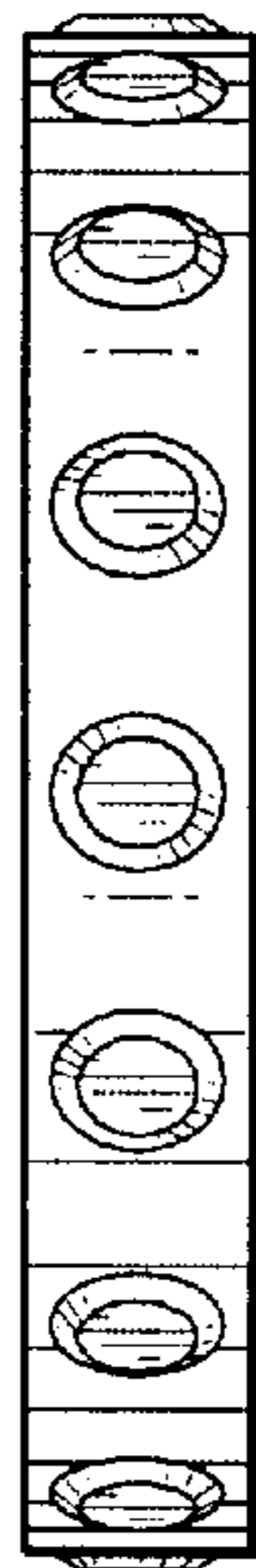

FIG. 42

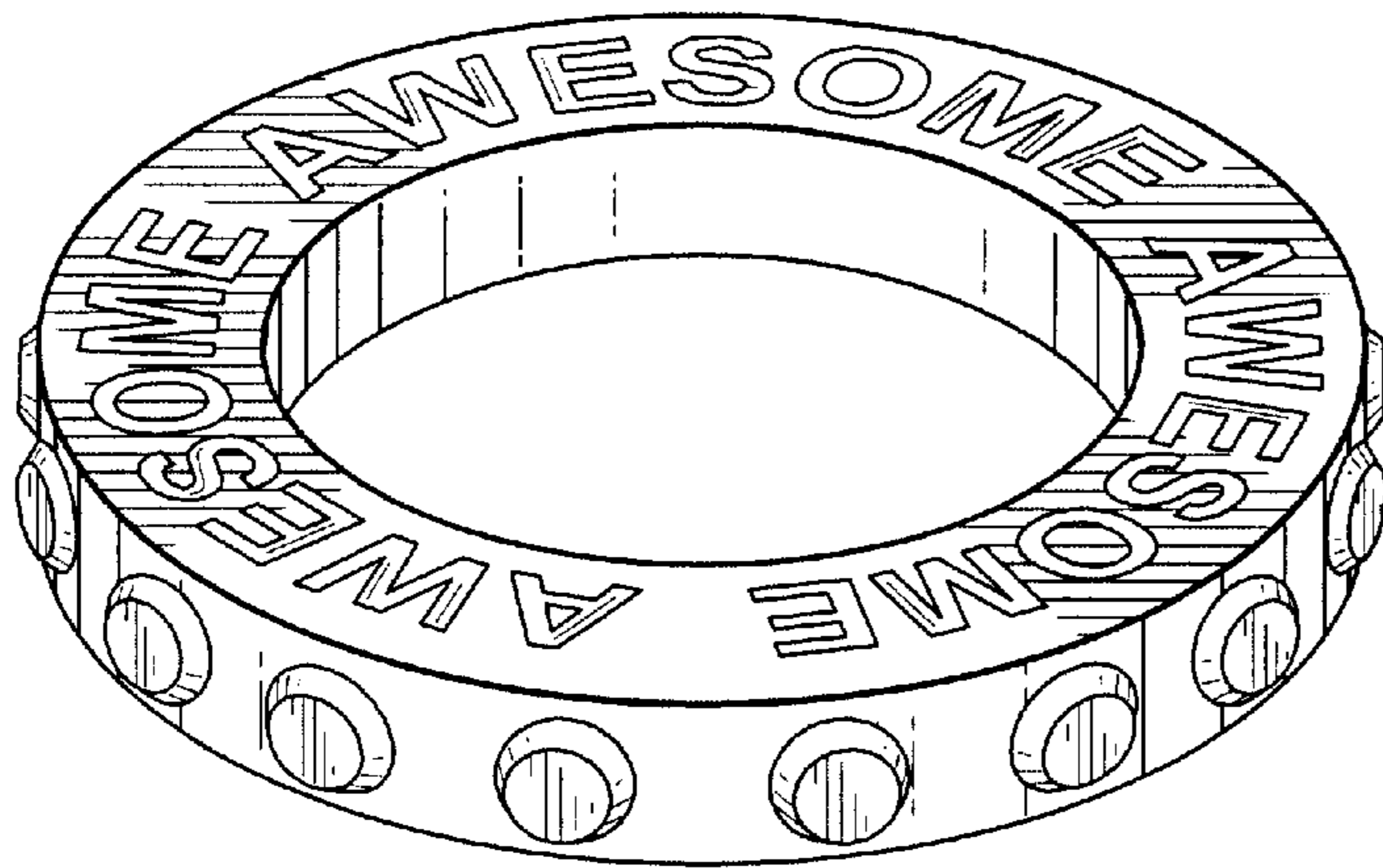

FIG. 43



FIG. 44

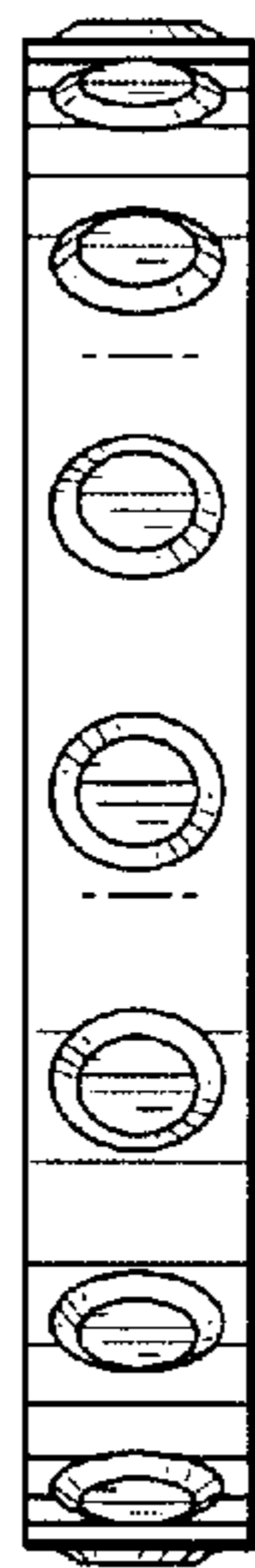

FIG. 45

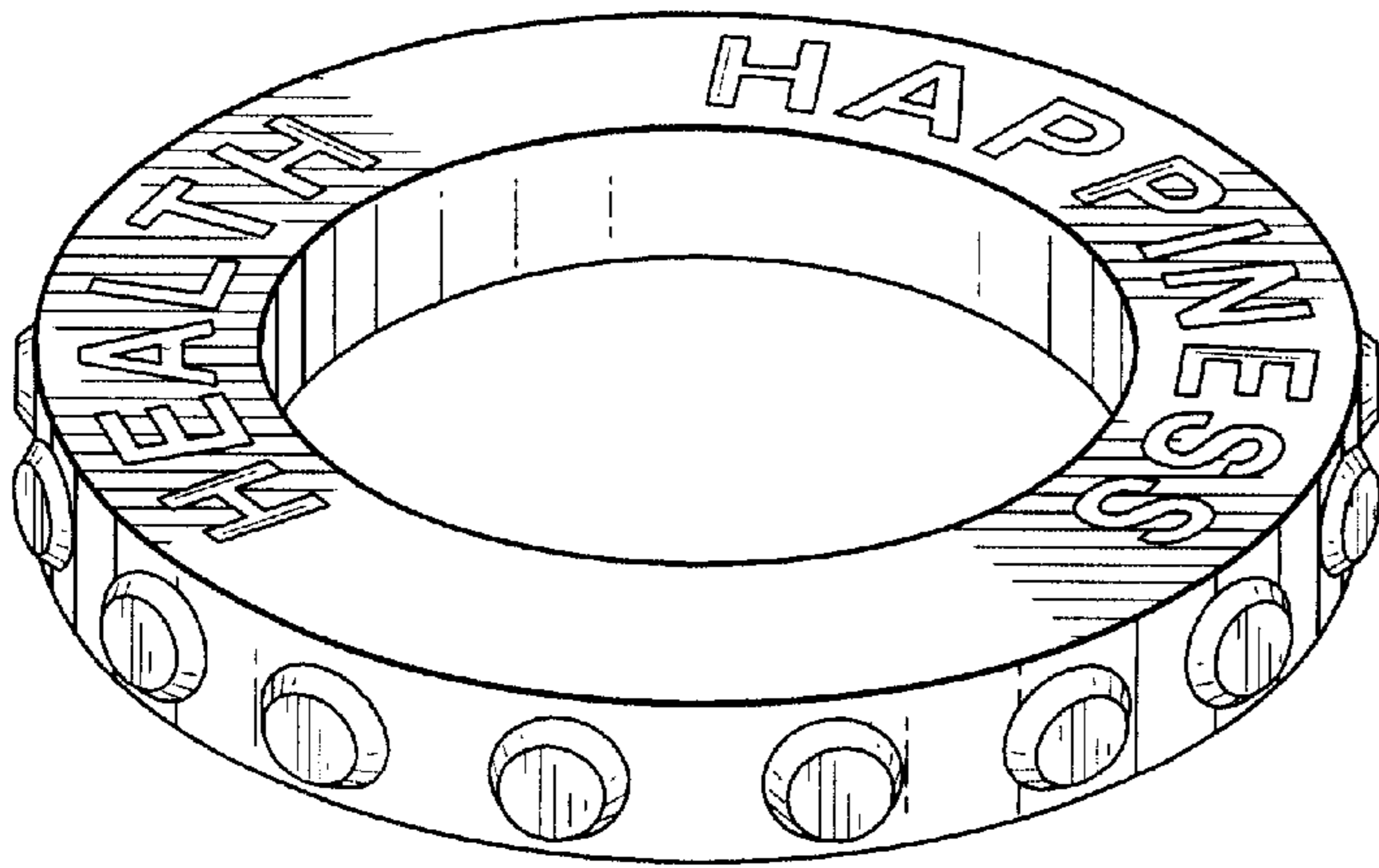

FIG. 46



FIG. 47

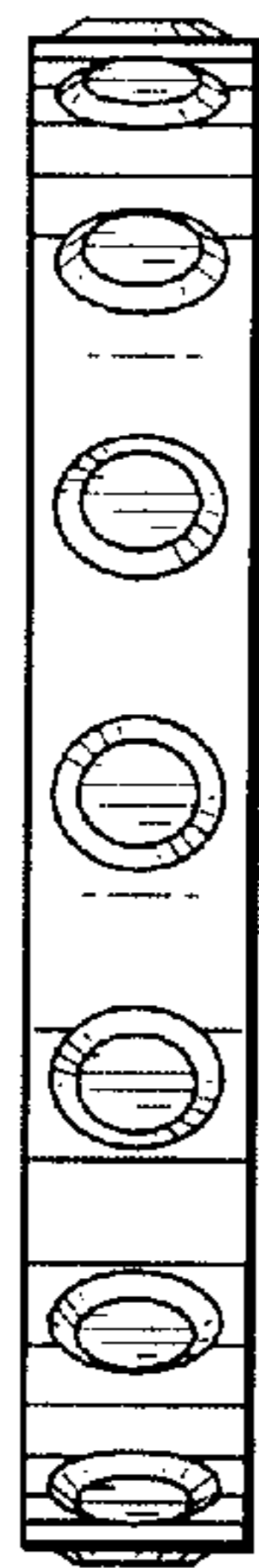

FIG. 48

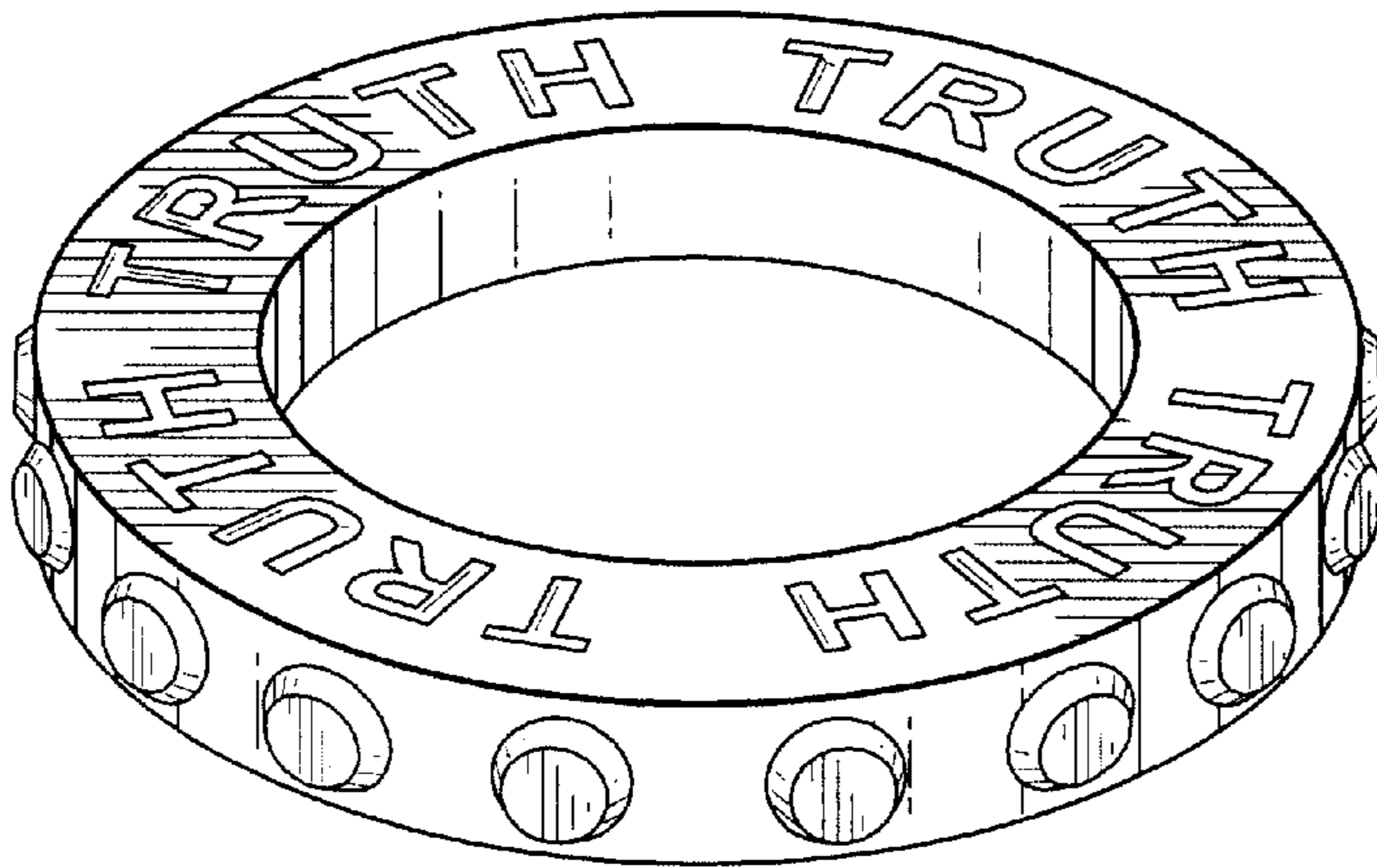

FIG. 49

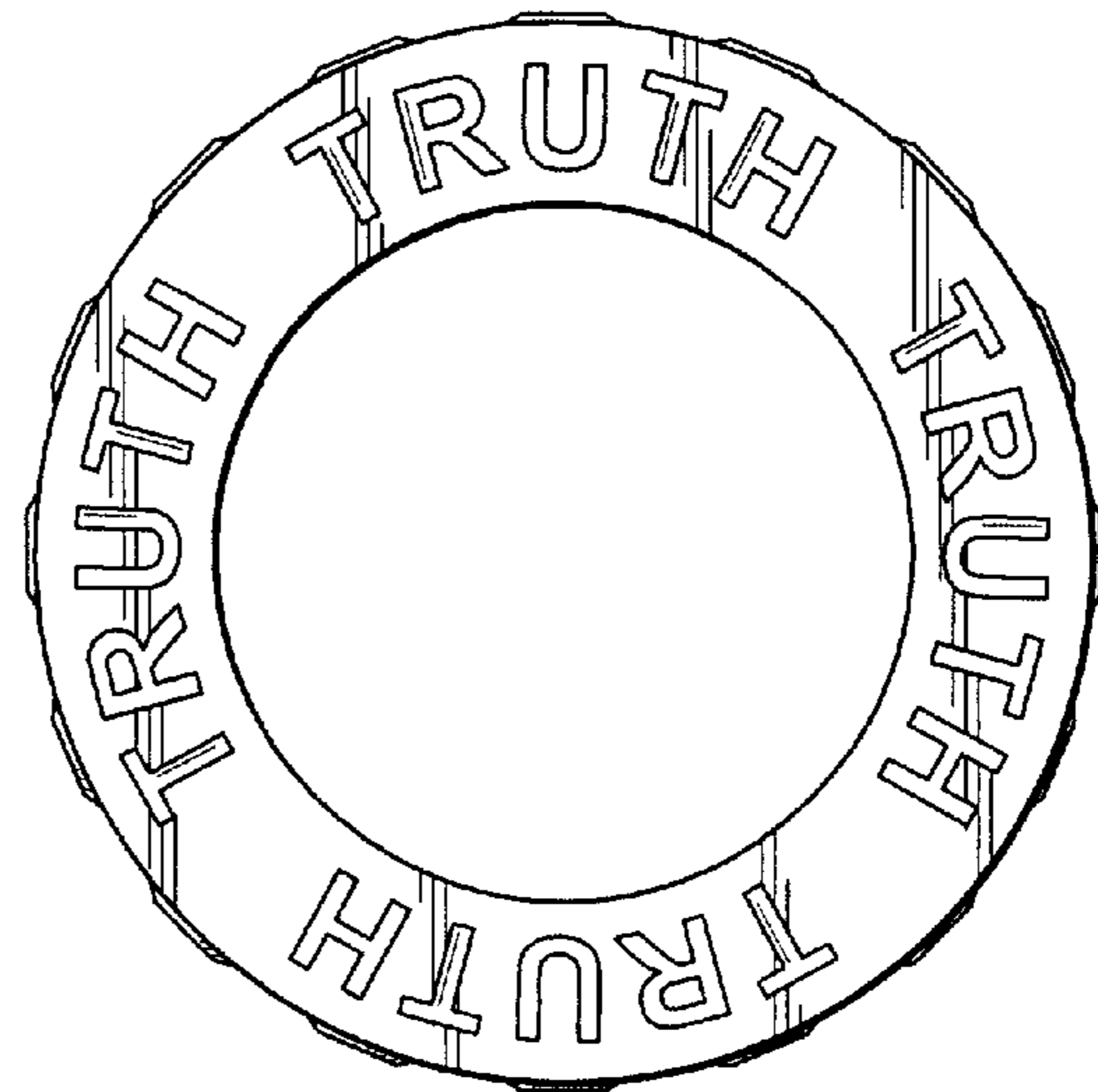

FIG. 50

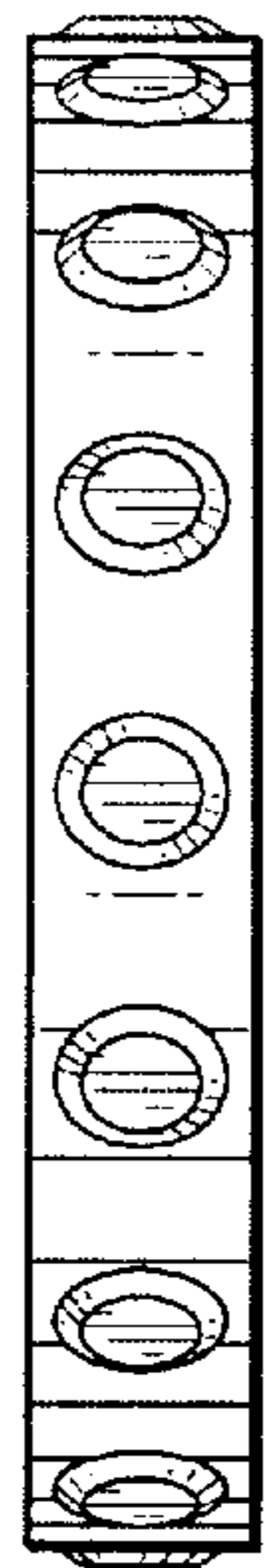

FIG. 51

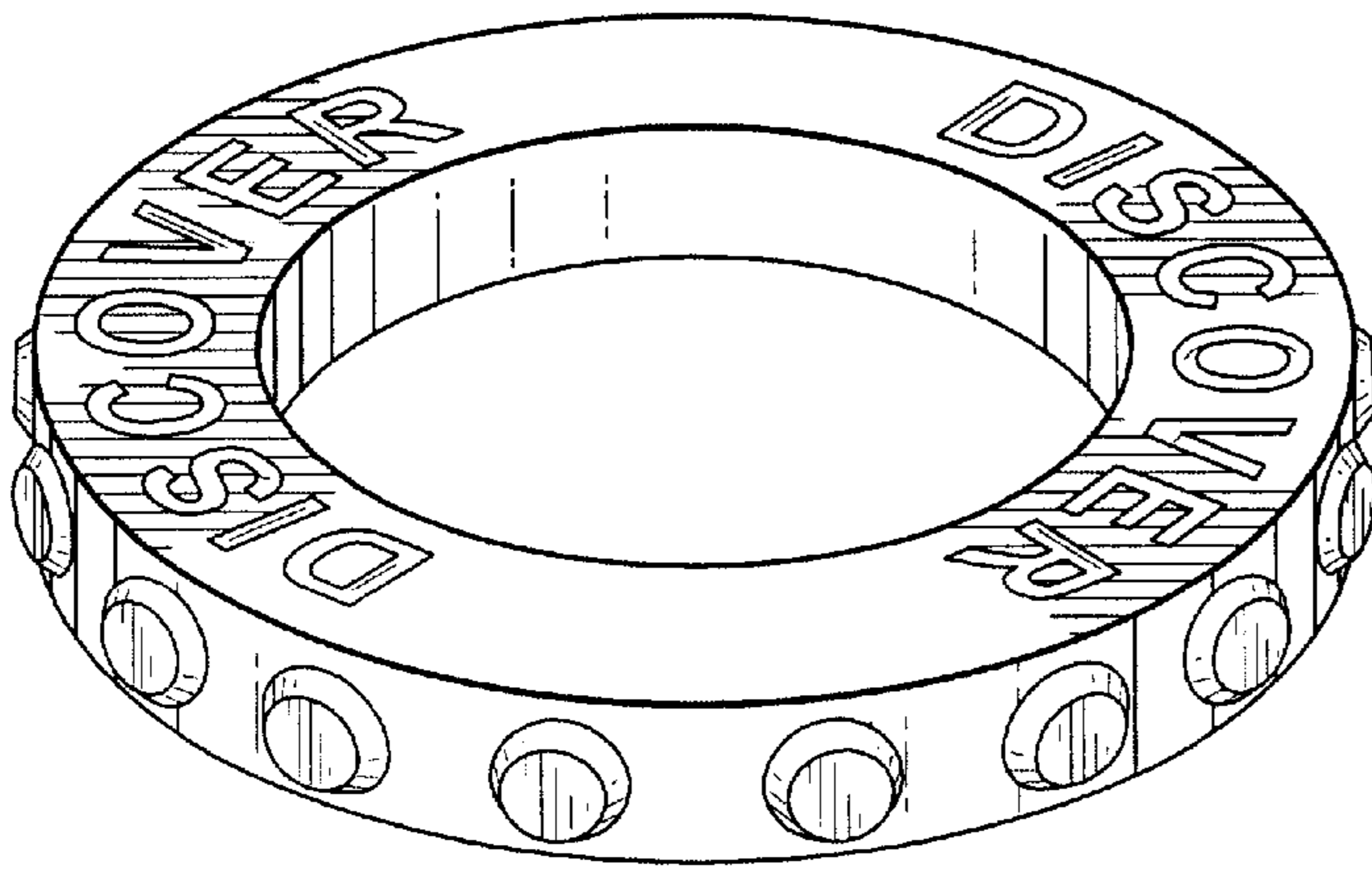

FIG. 52



FIG. 53

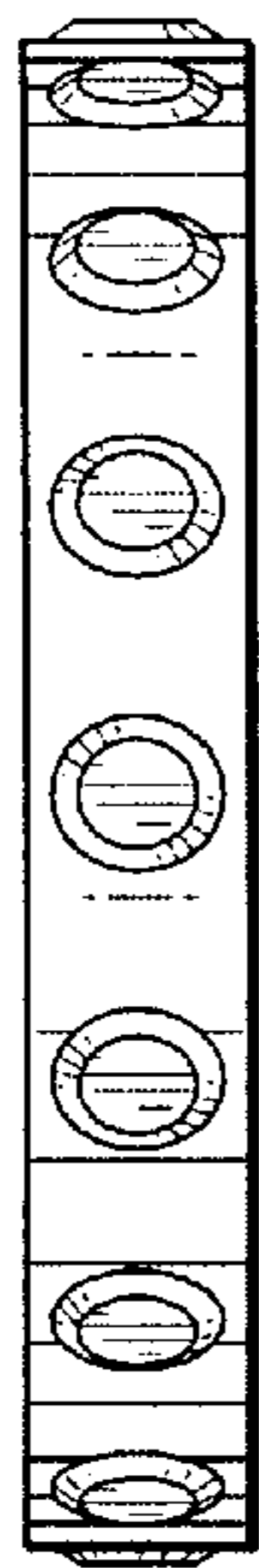

FIG. 54

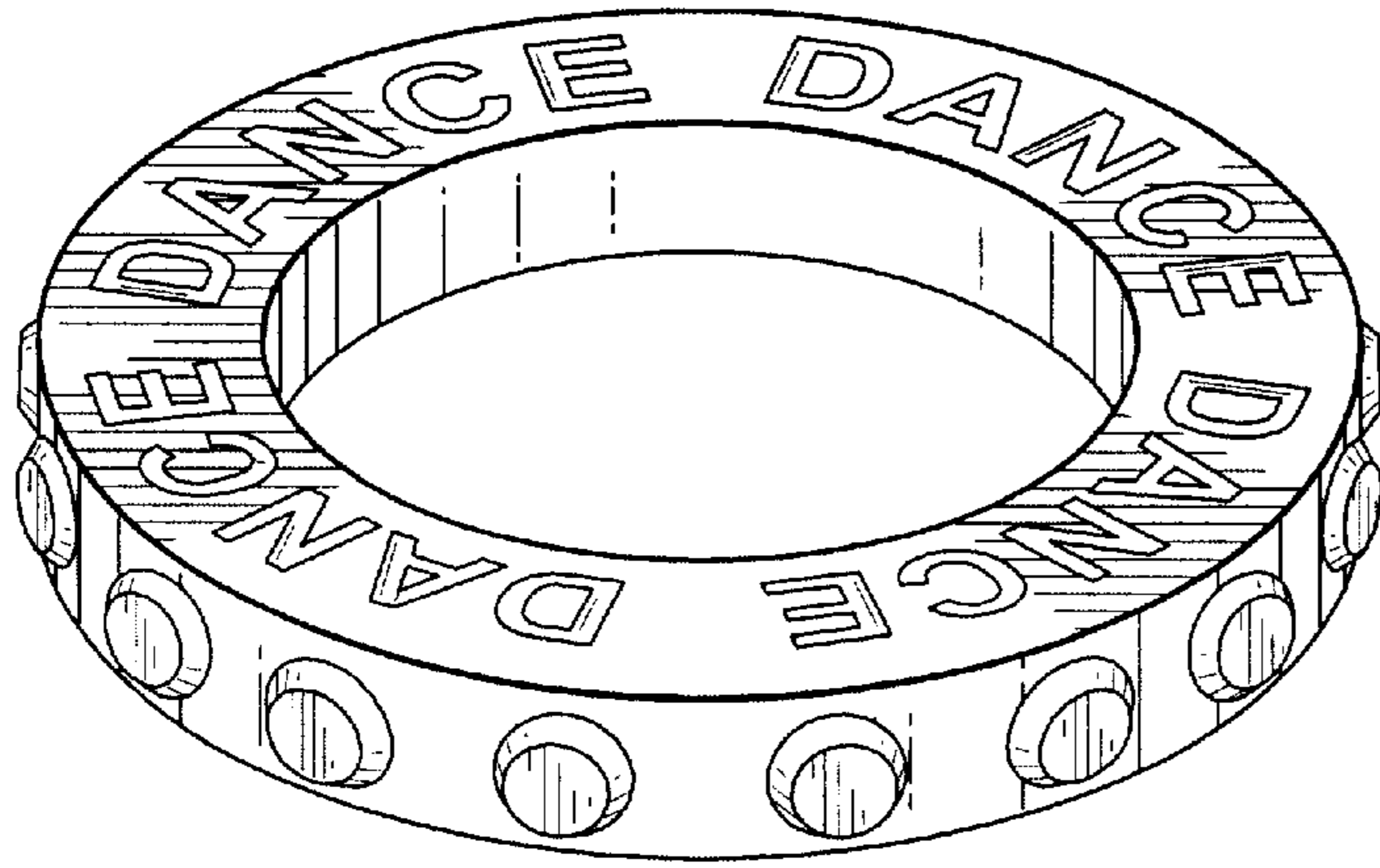

FIG. 55

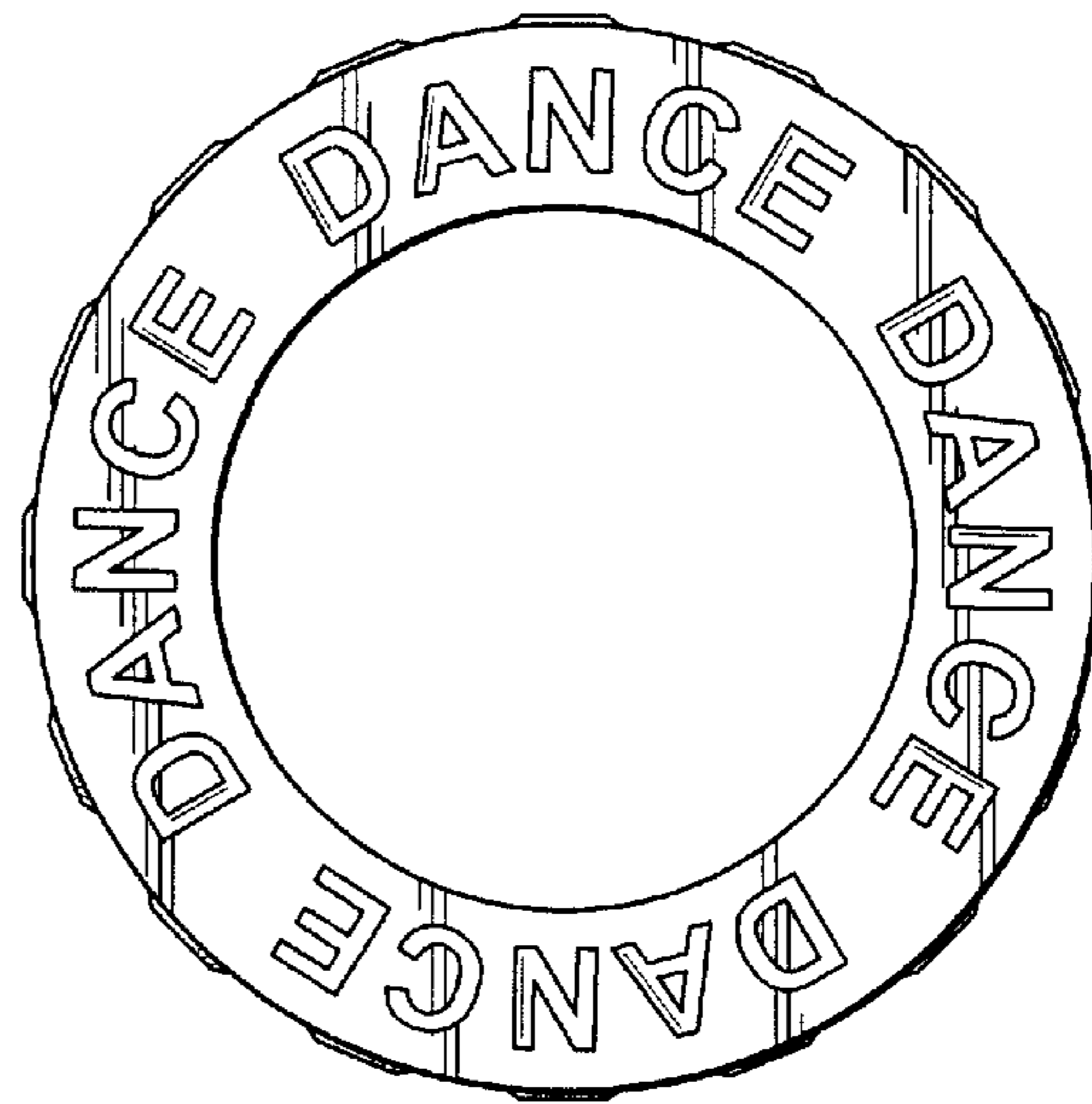

FIG. 56

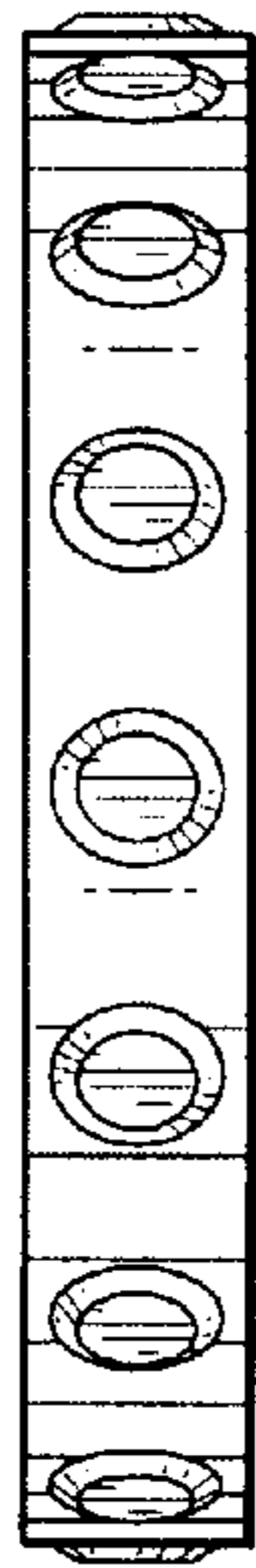

FIG. 57

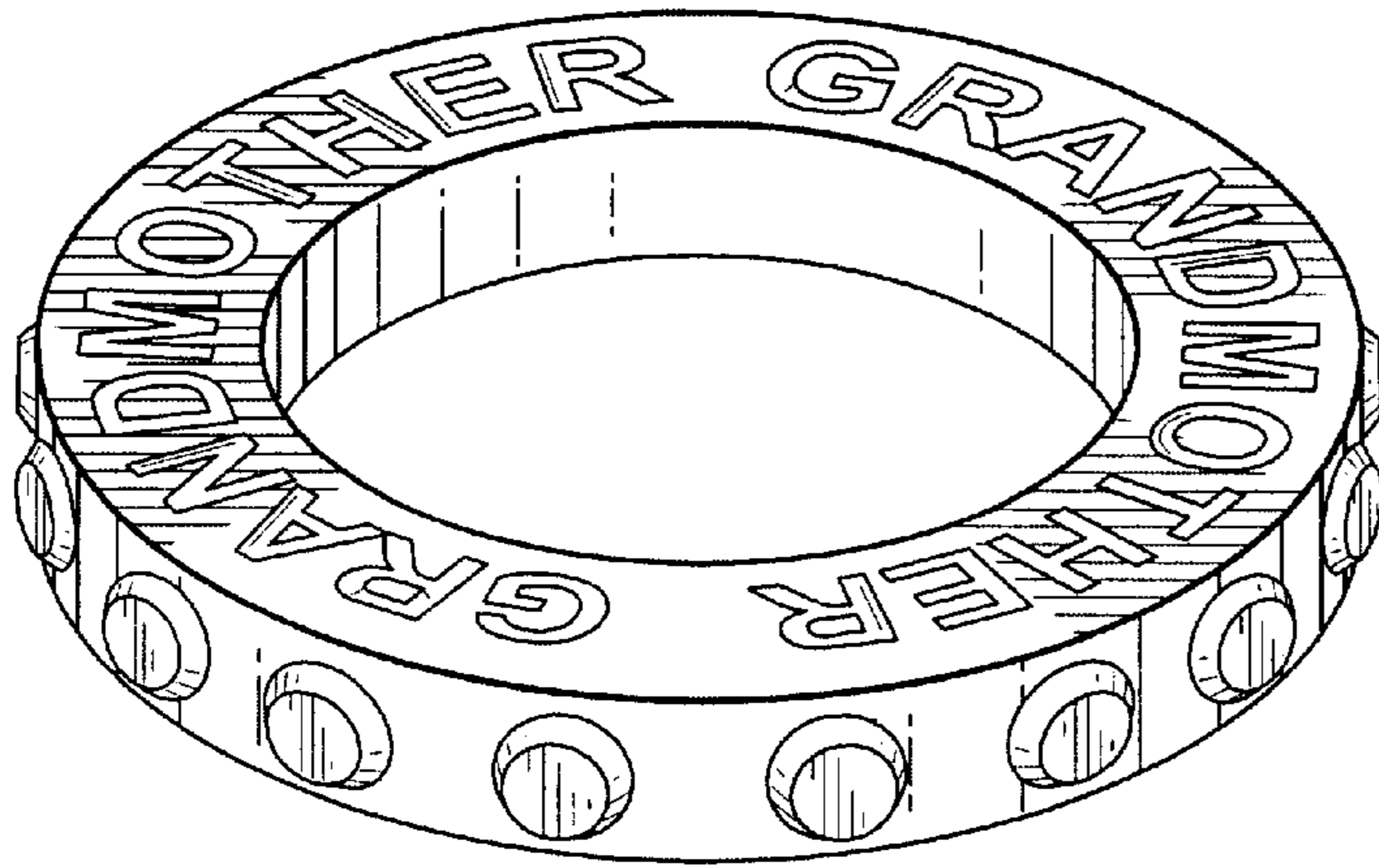

FIG. 58



FIG. 59

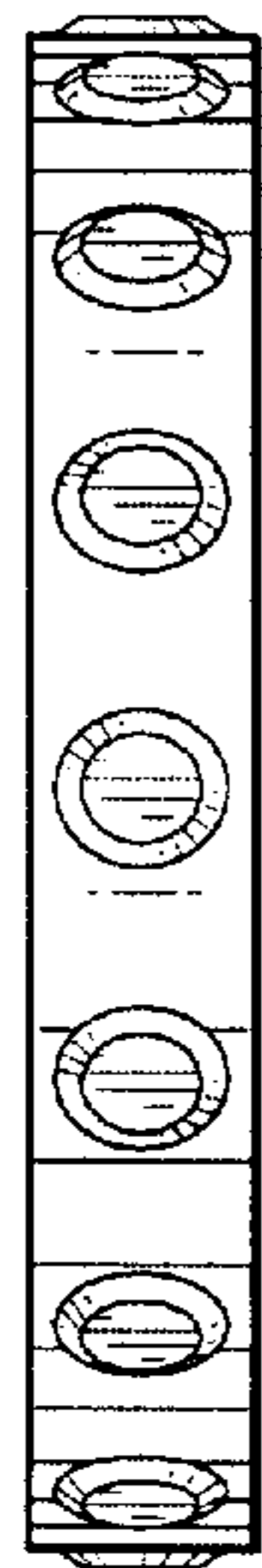

FIG. 60

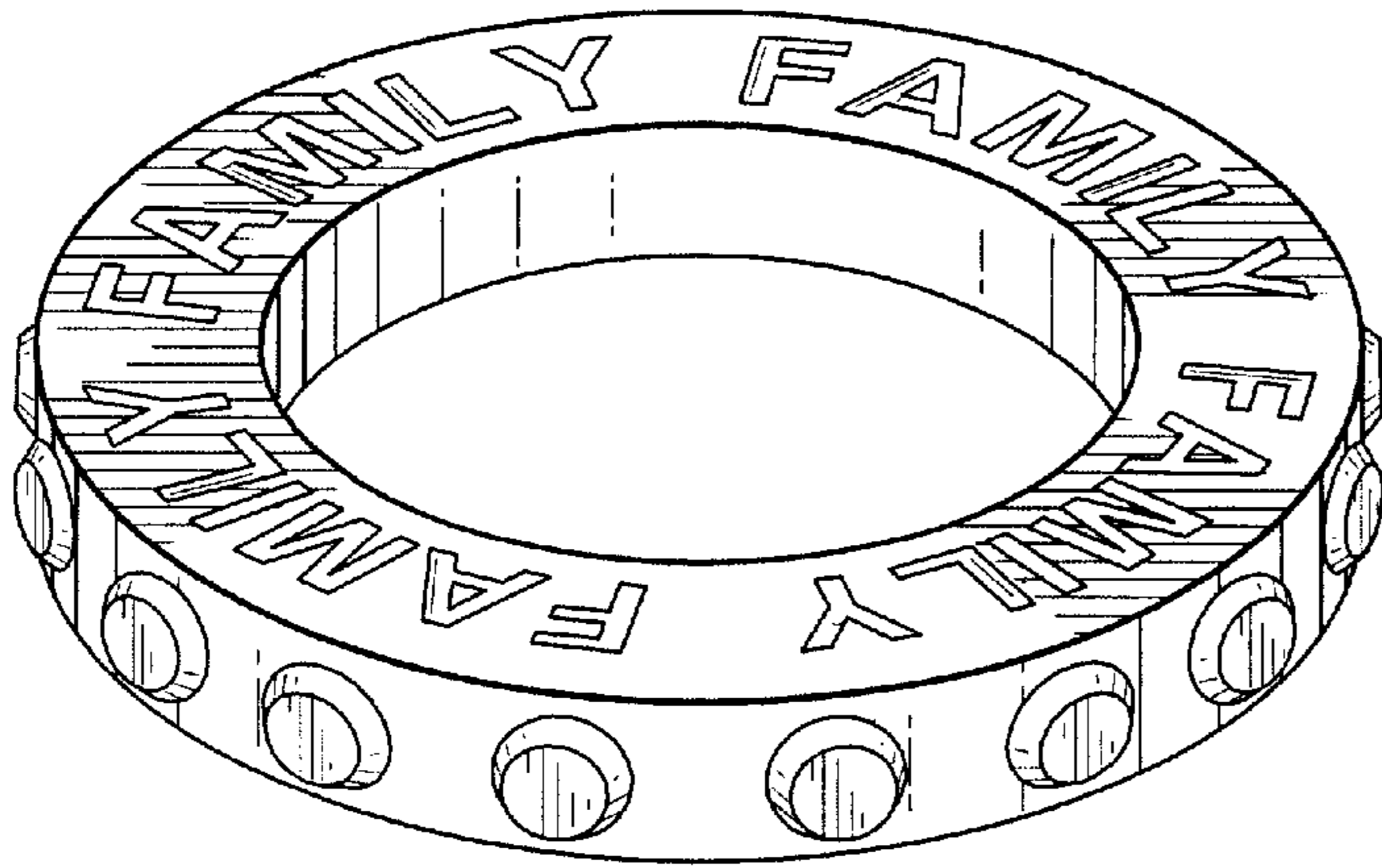

FIG. 61

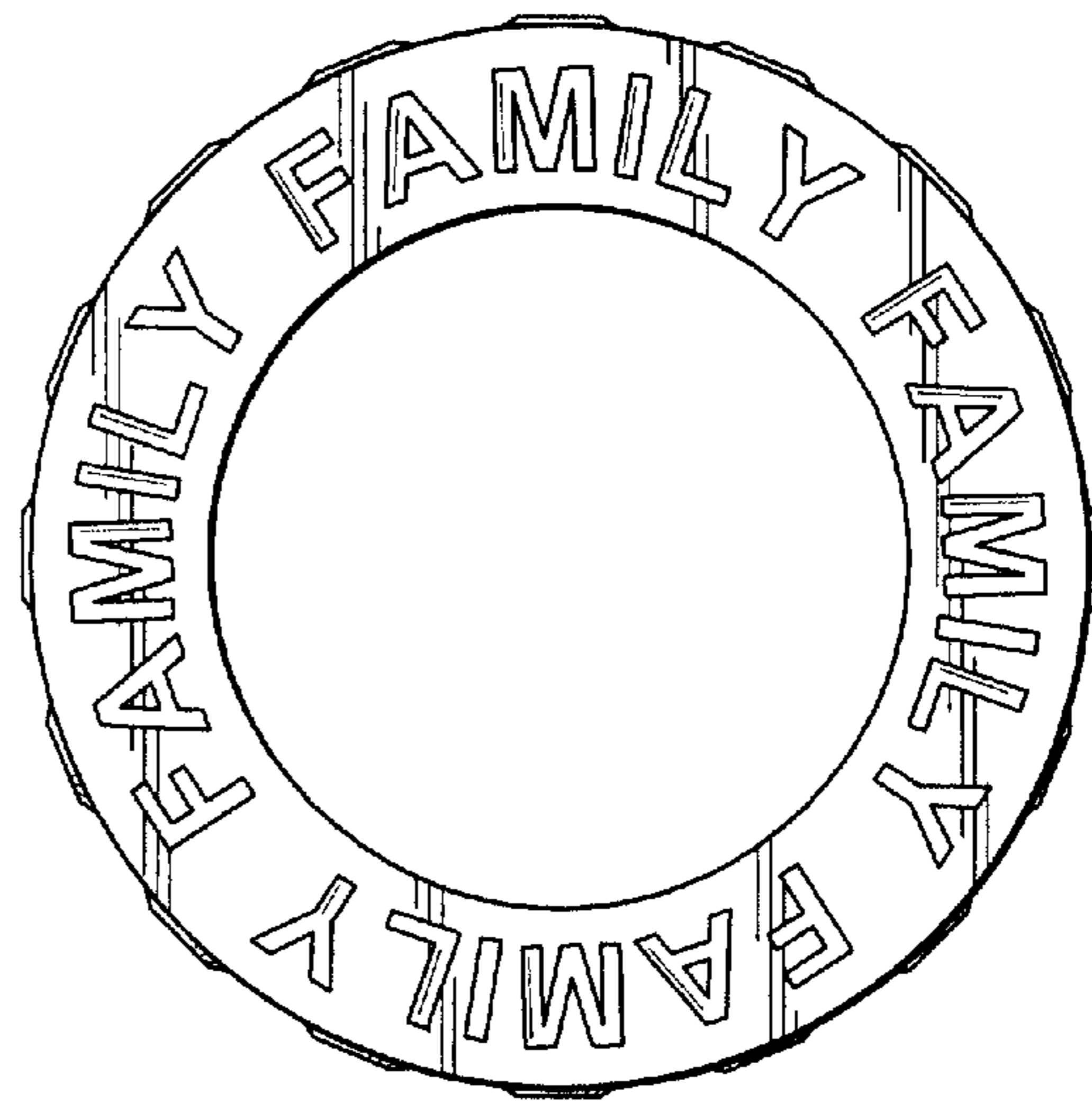

FIG. 62

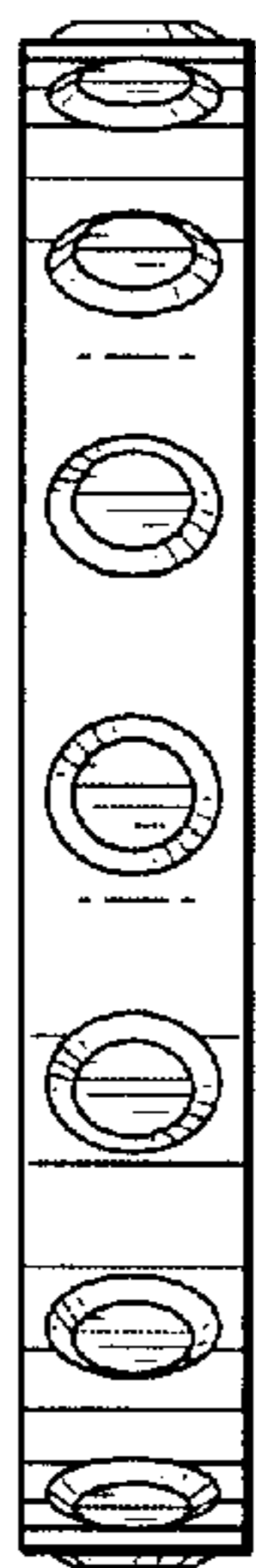

FIG. 63

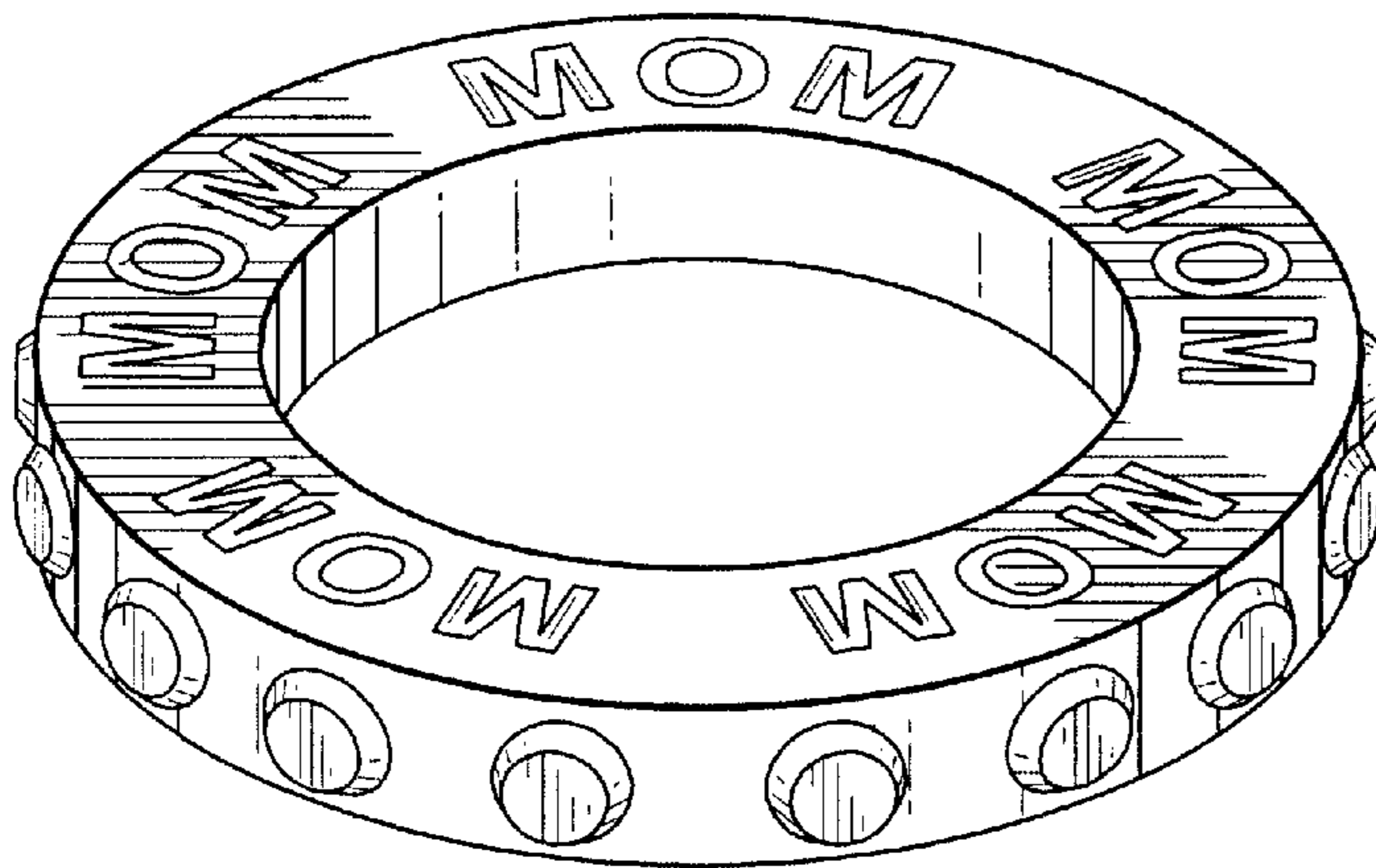

FIG. 64

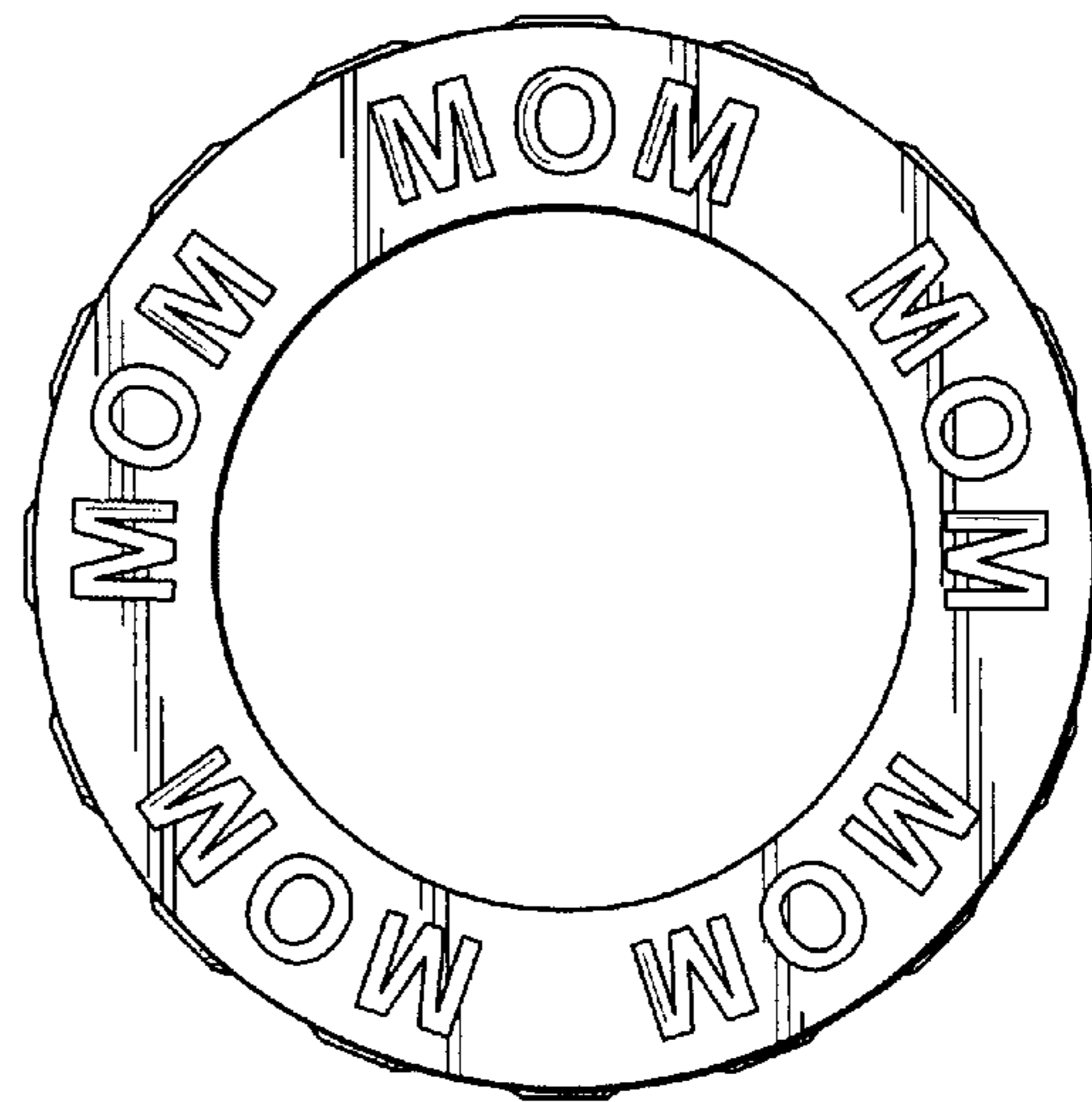

FIG. 65

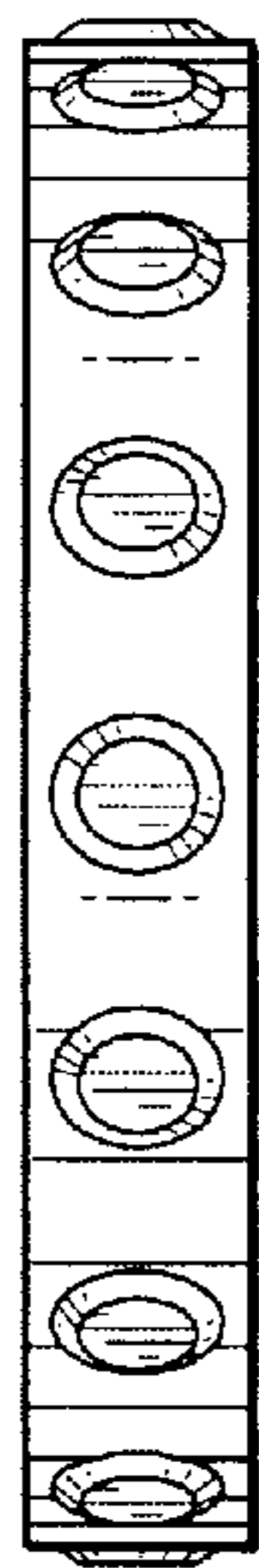

FIG. 66

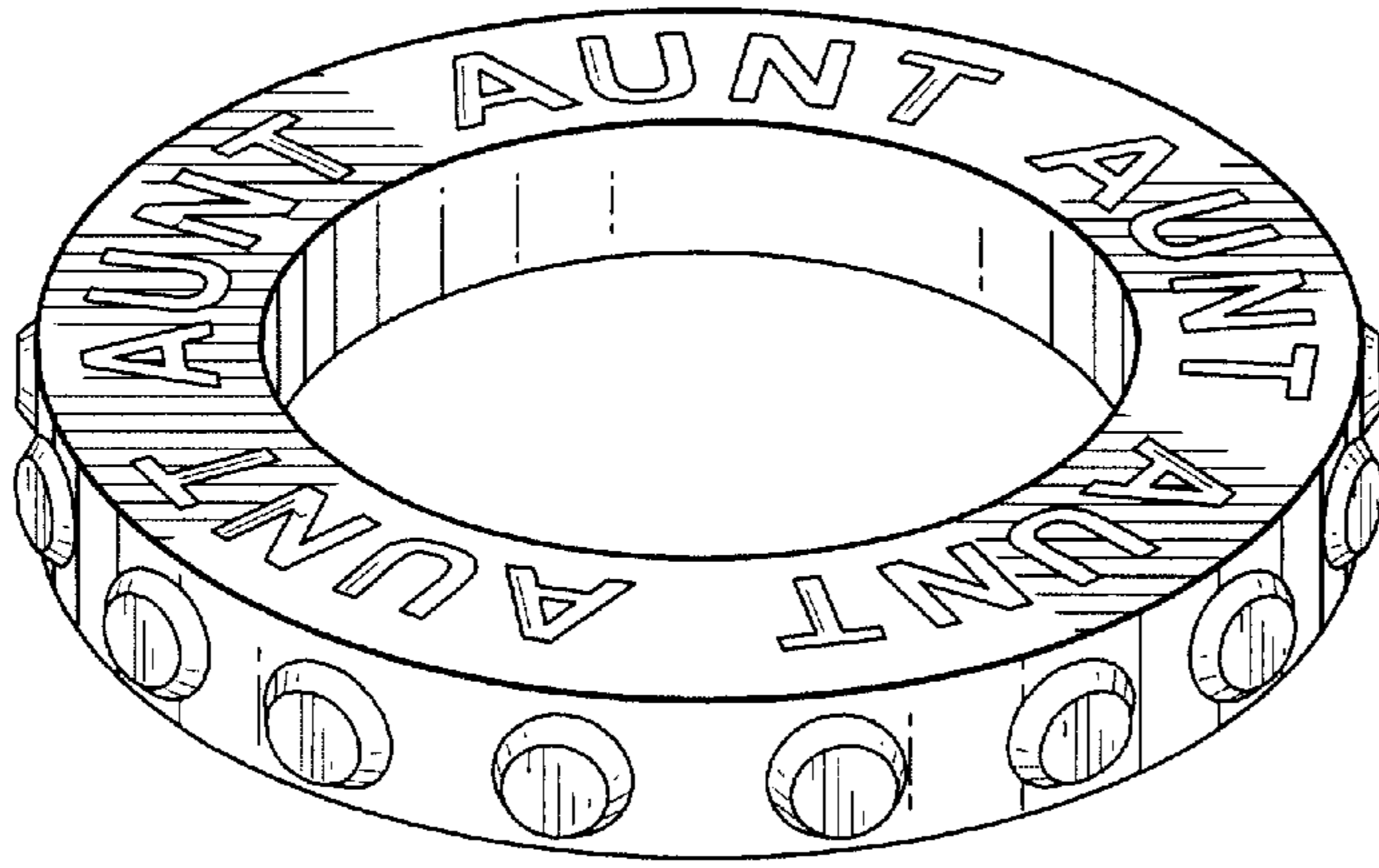

FIG. 67

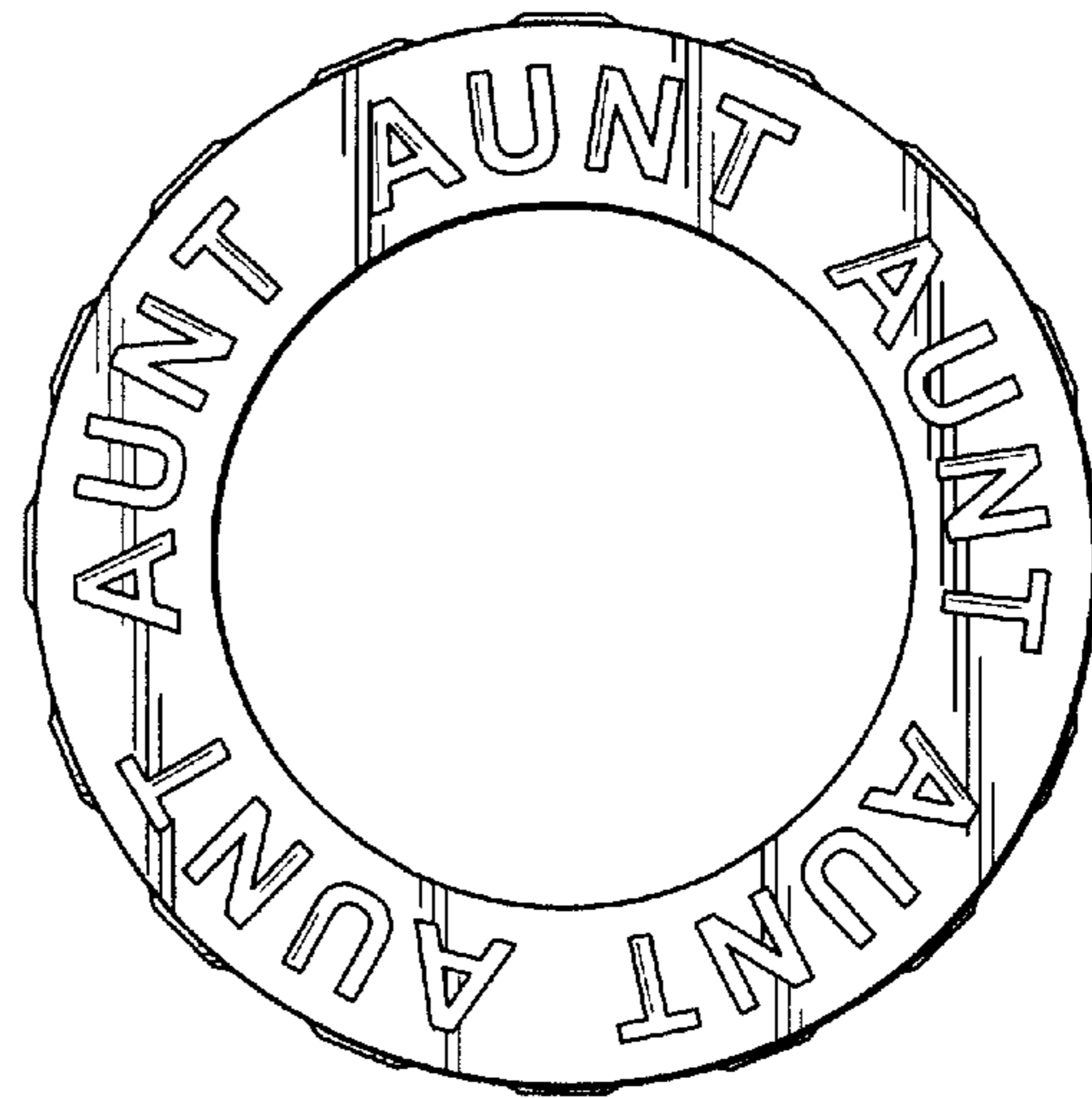

FIG. 68

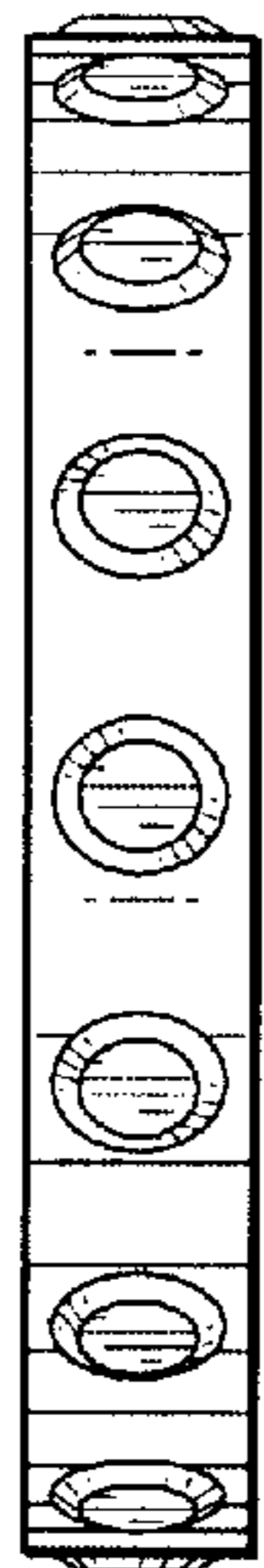

FIG. 69

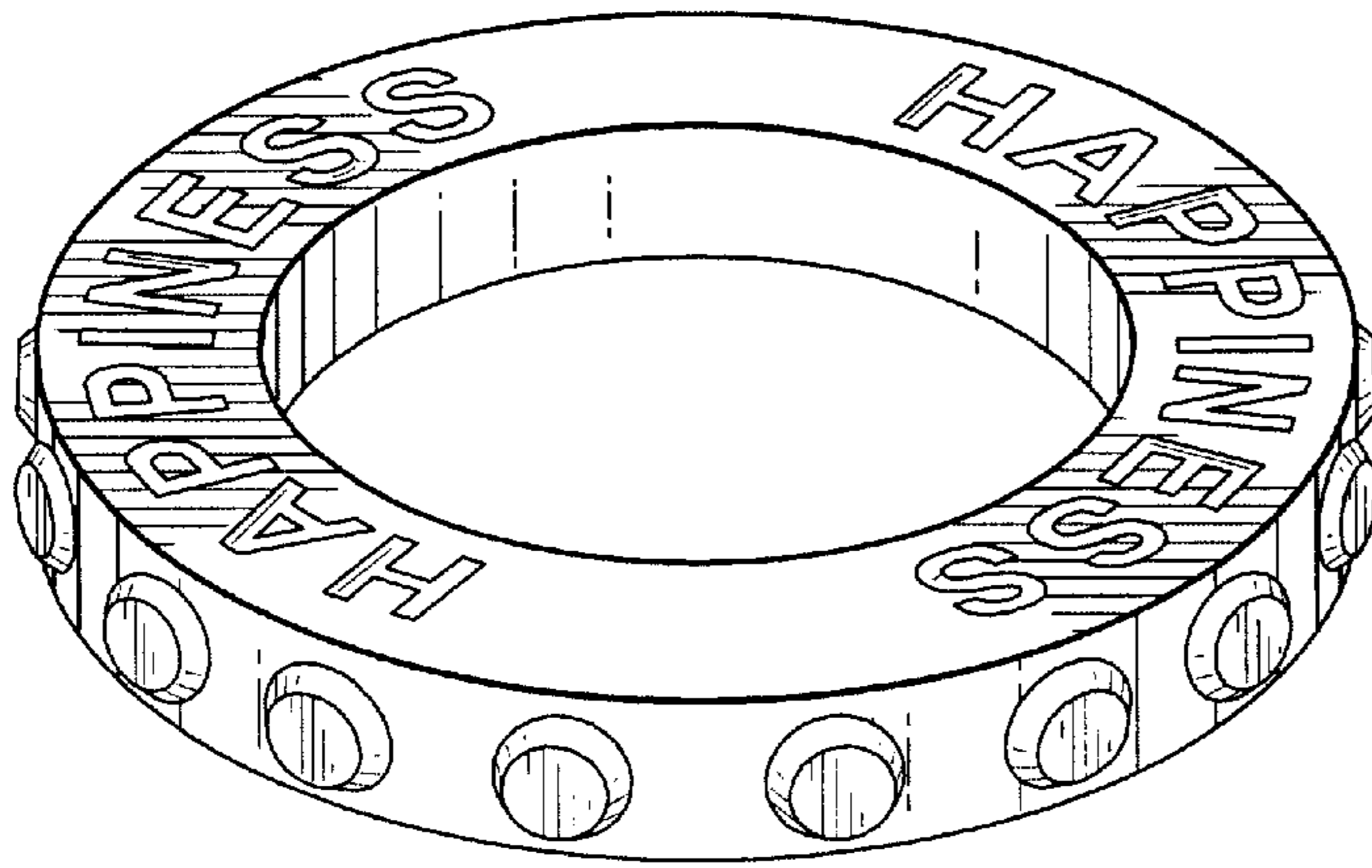

FIG. 70

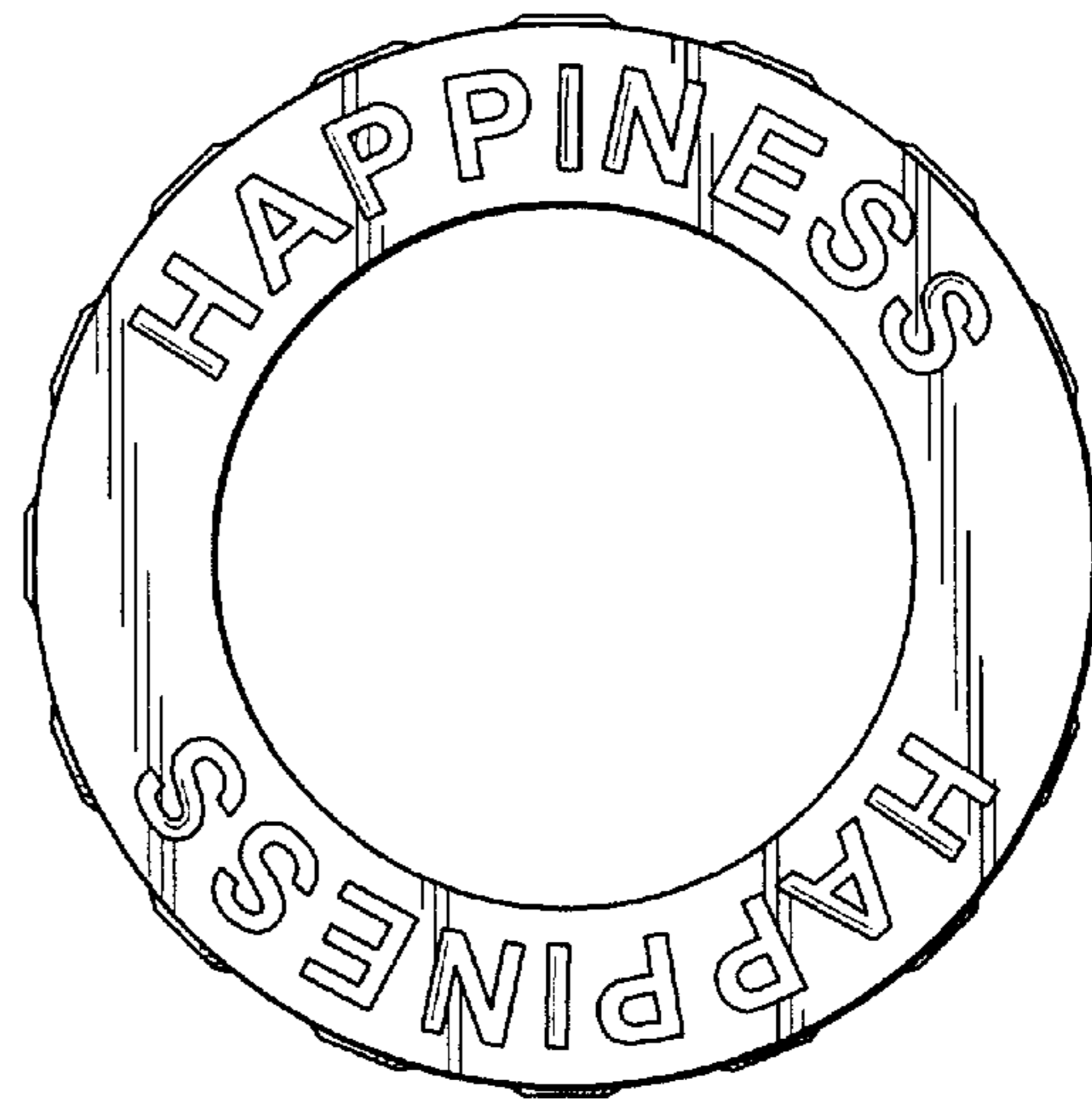

FIG. 71

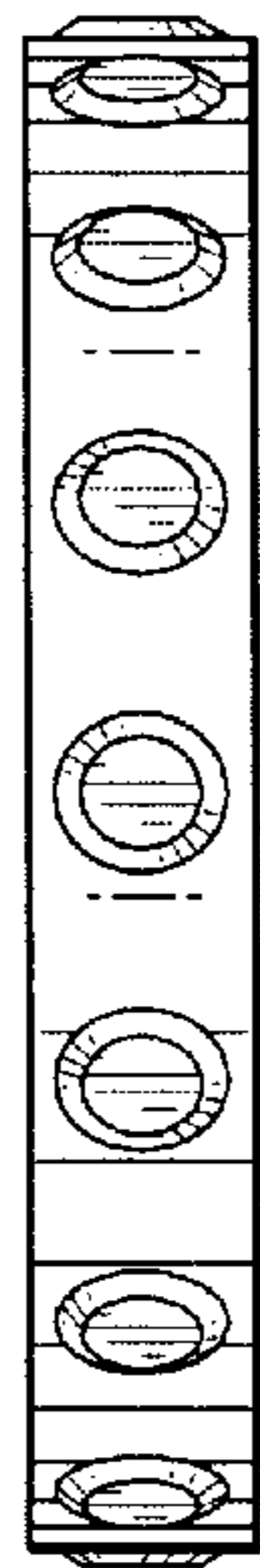

FIG. 72

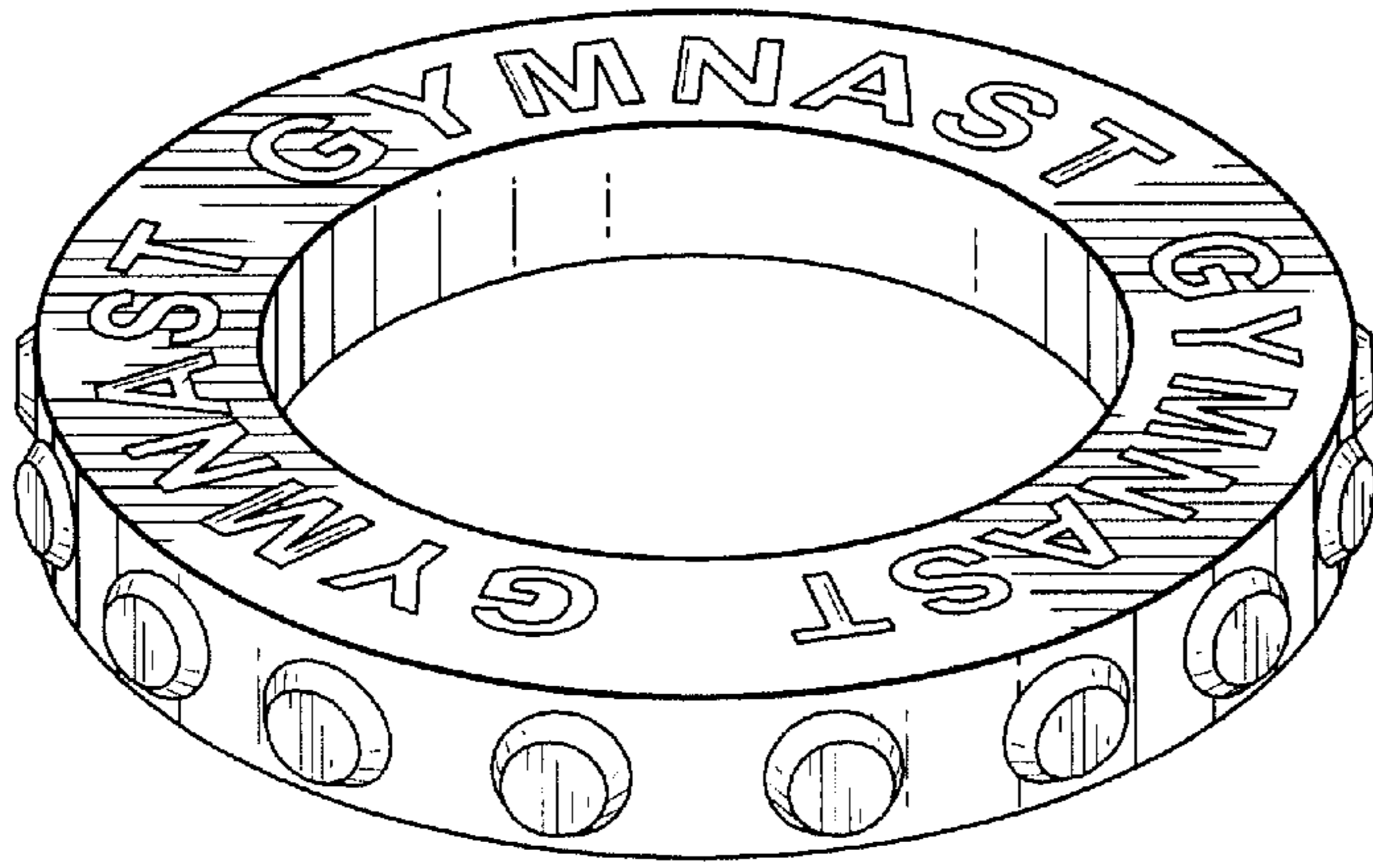

FIG. 73

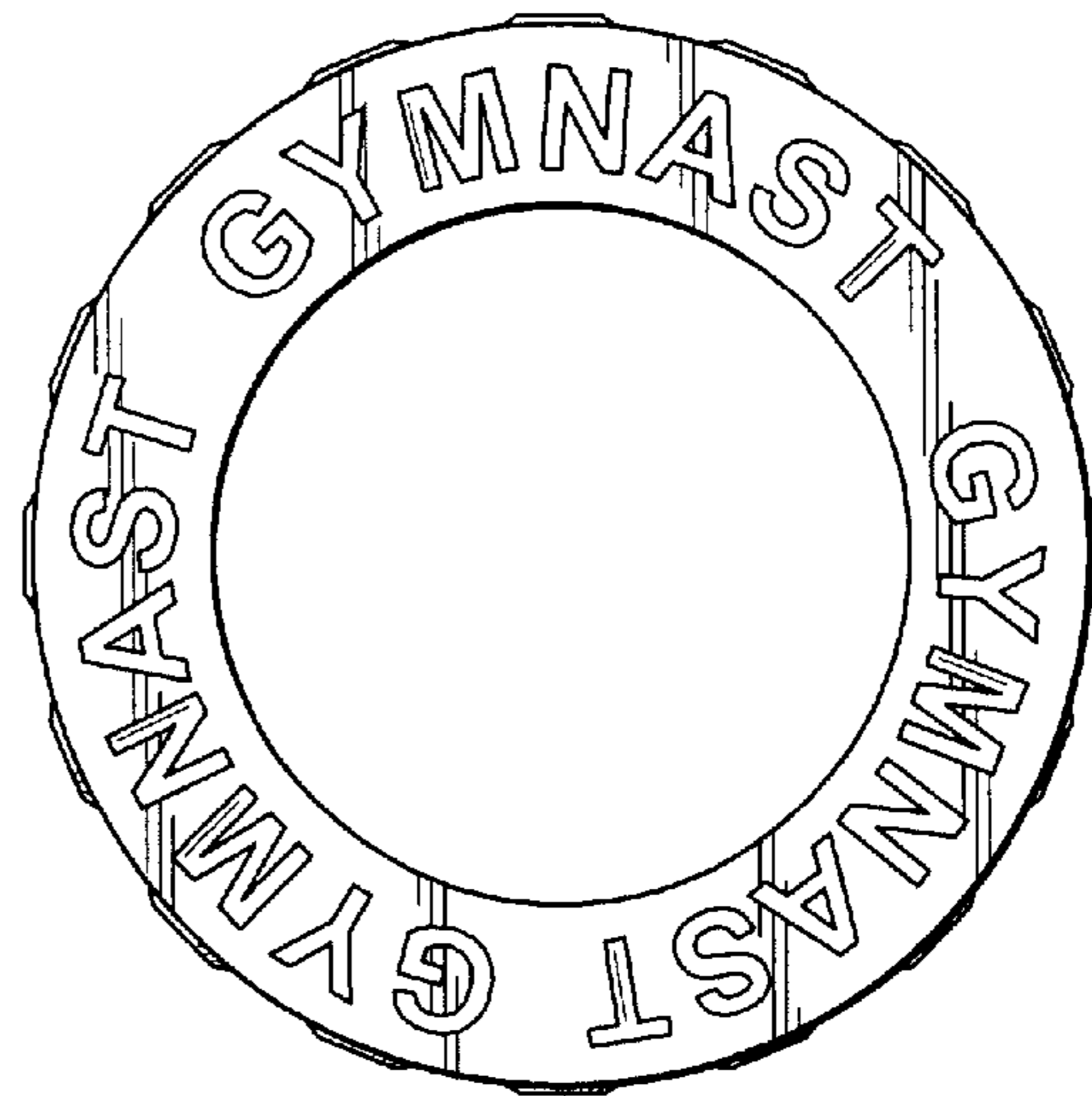

FIG. 74

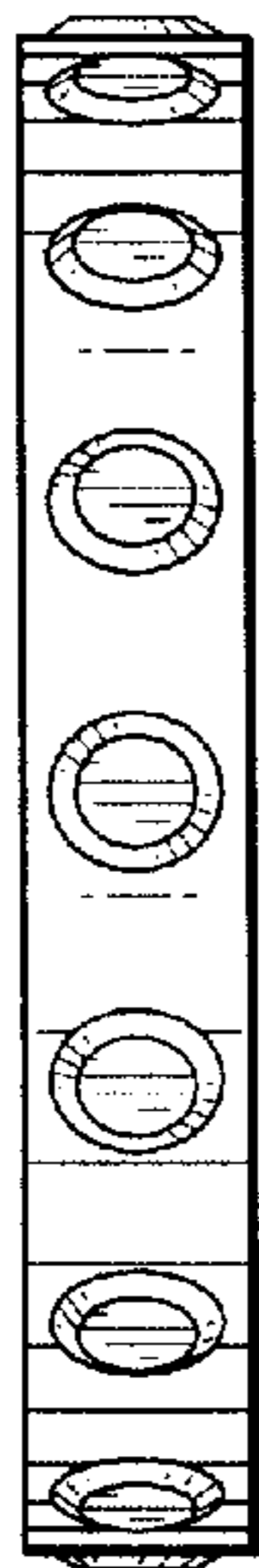

FIG. 75

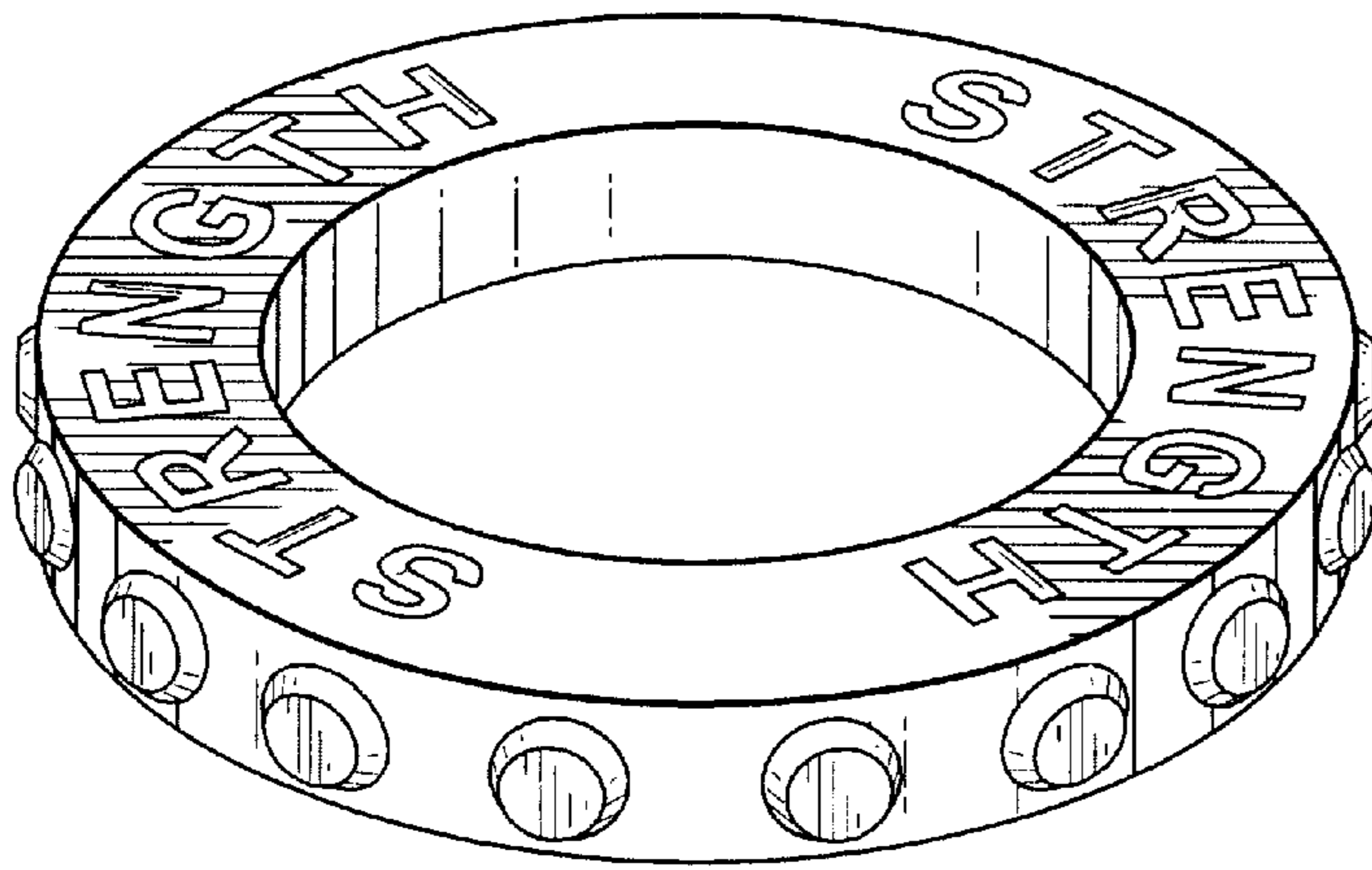

FIG. 76

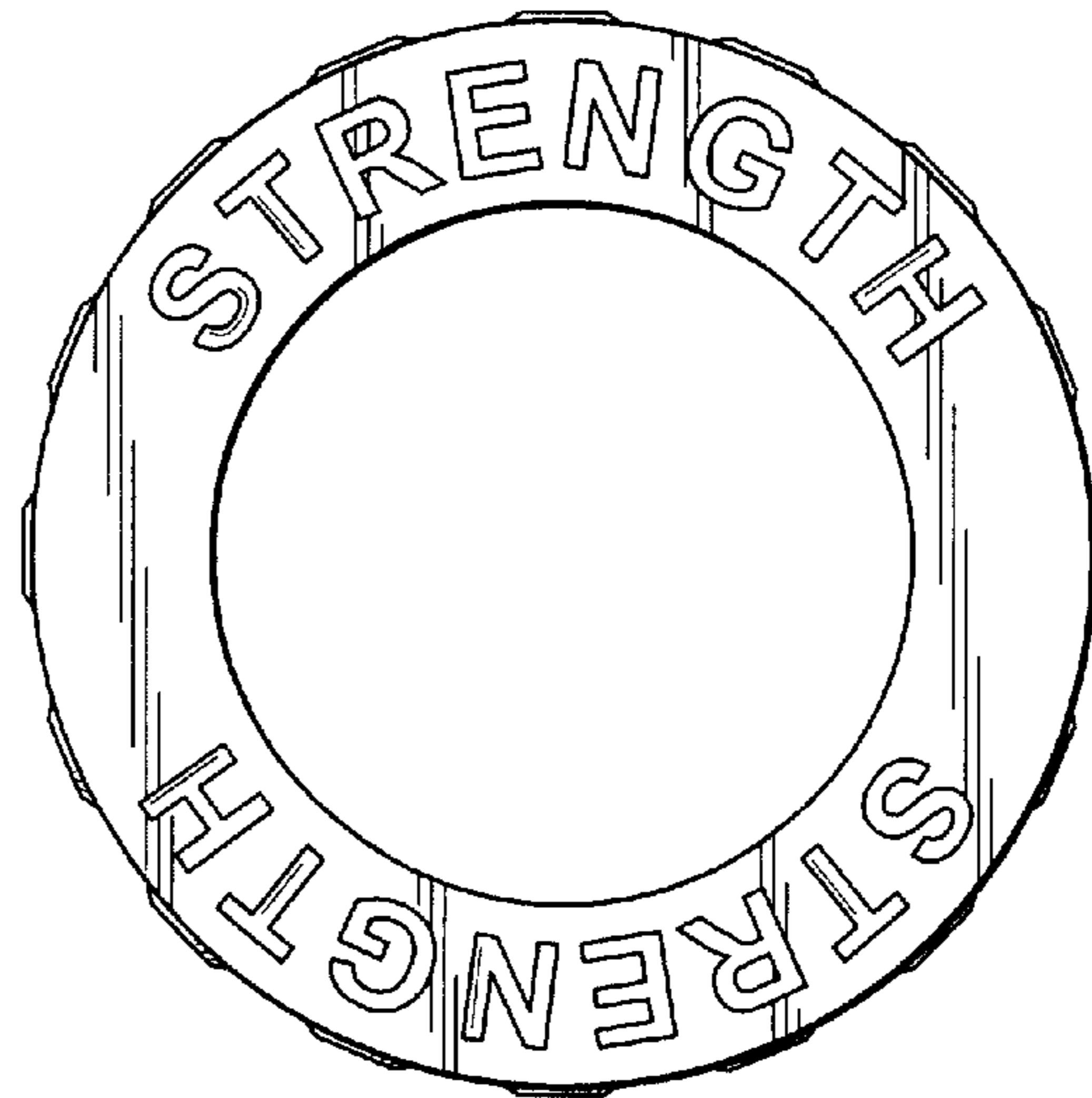

FIG. 77

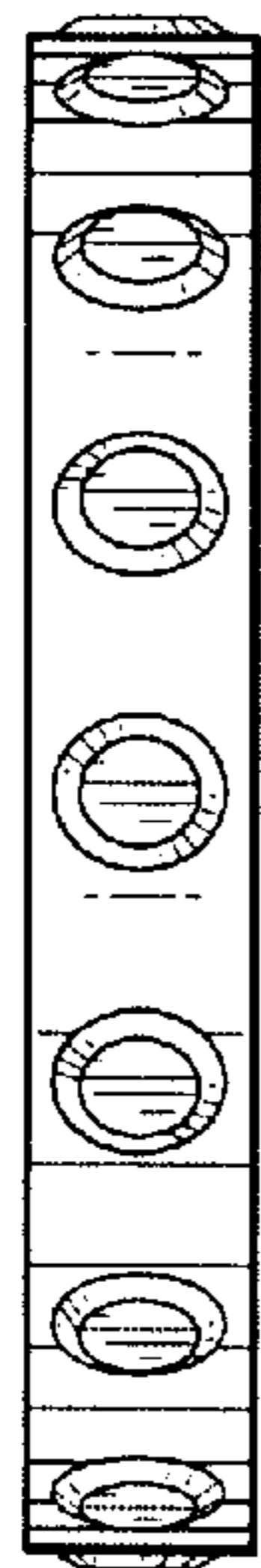

FIG. 78

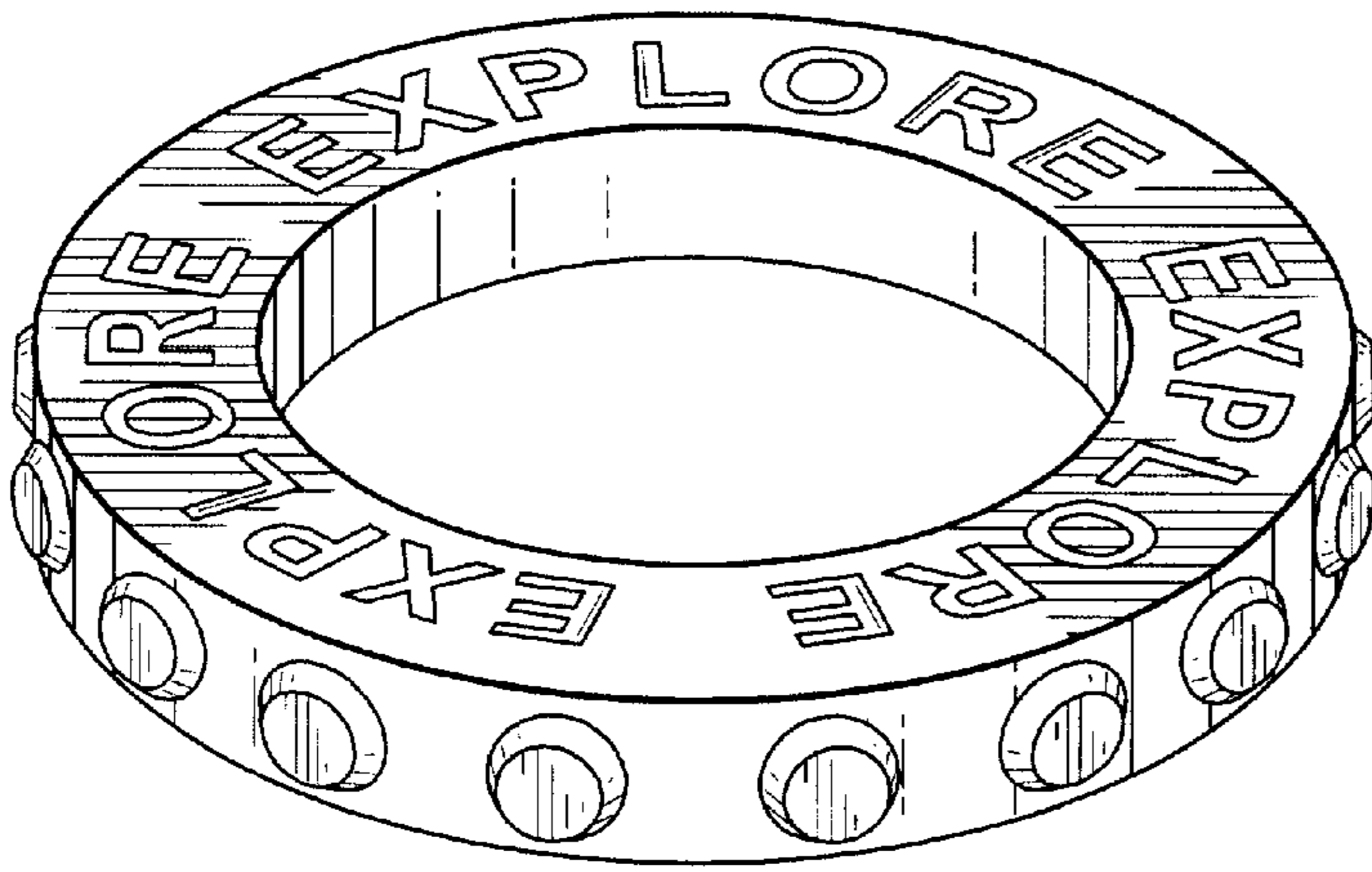

FIG. 79

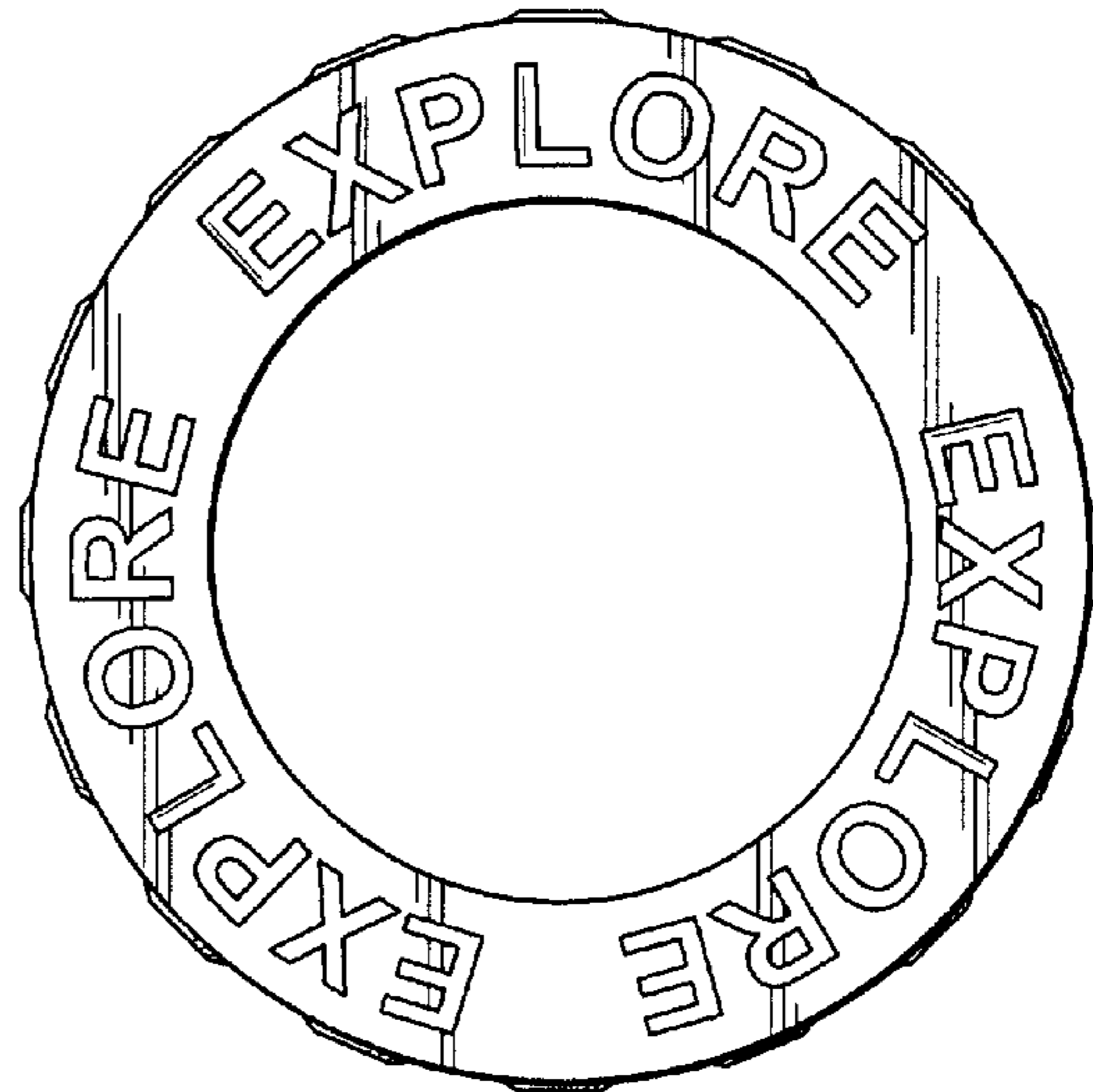

FIG. 80

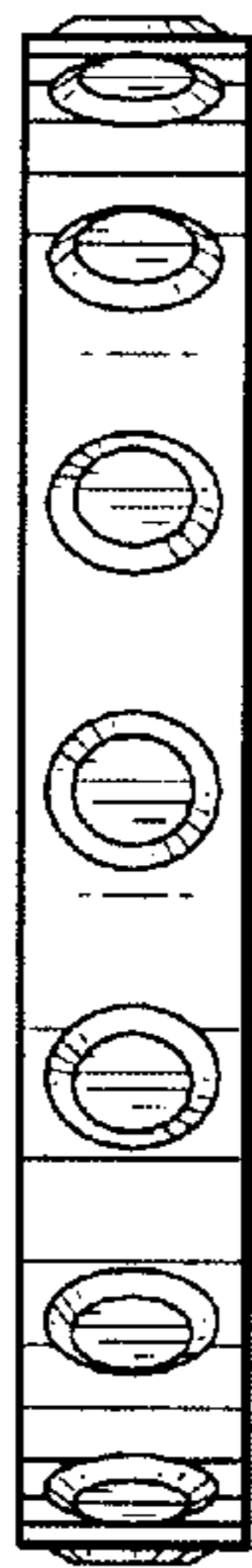

FIG. 81

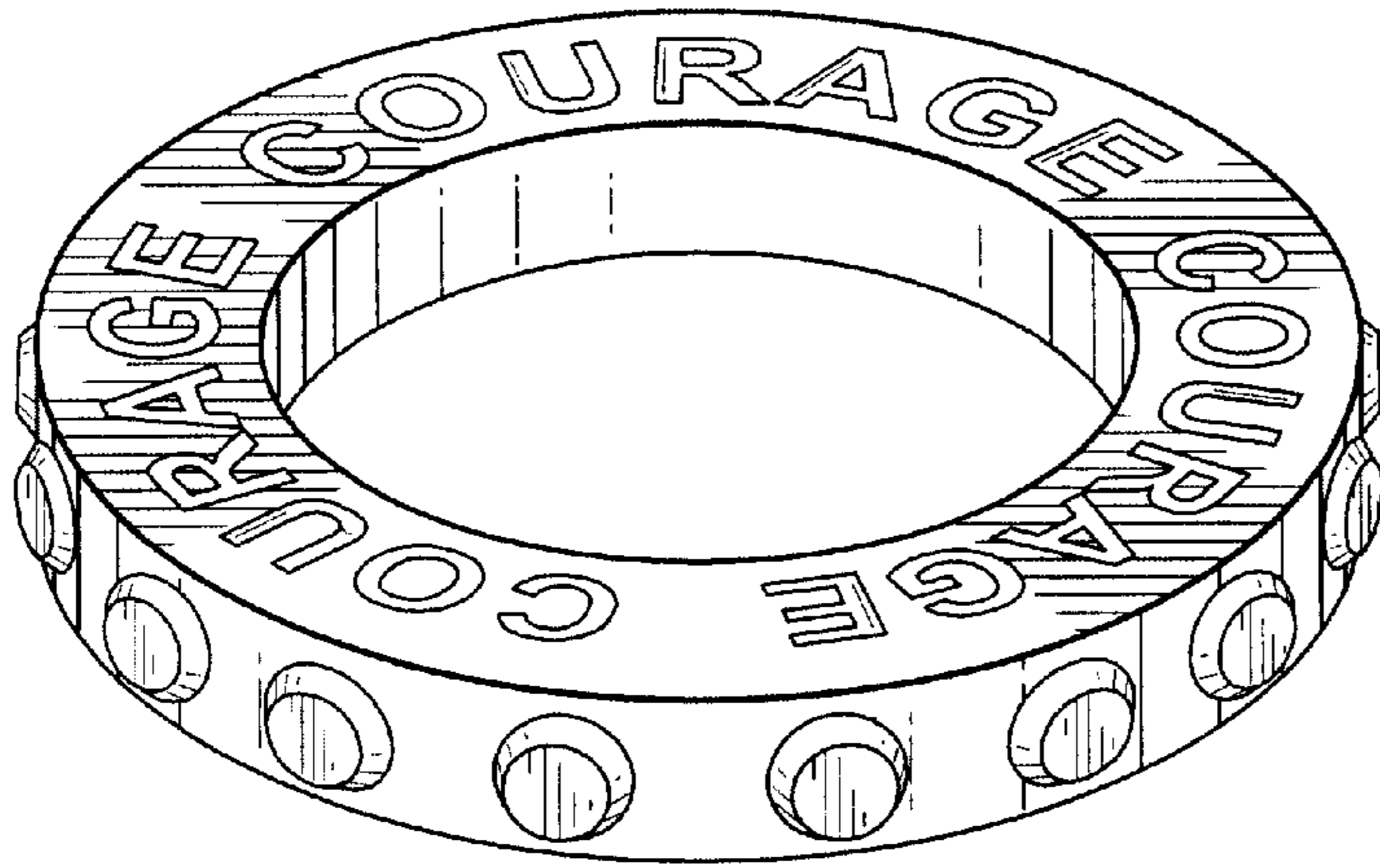

FIG. 82



FIG. 83

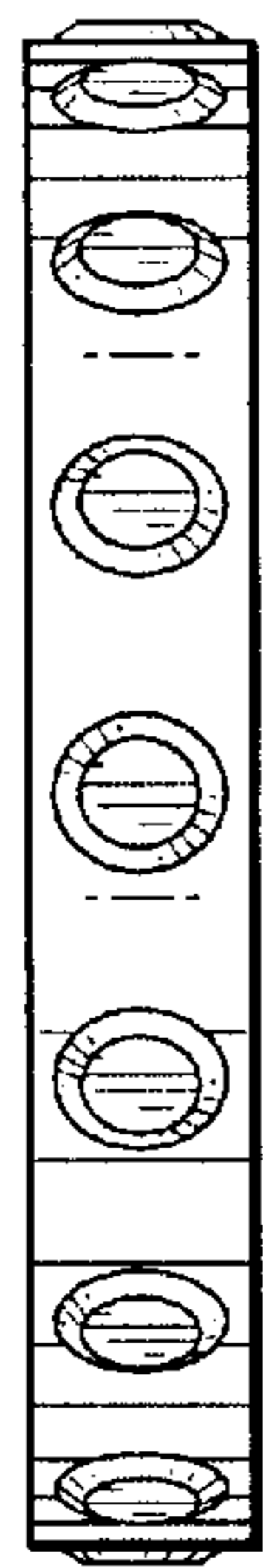

FIG. 84

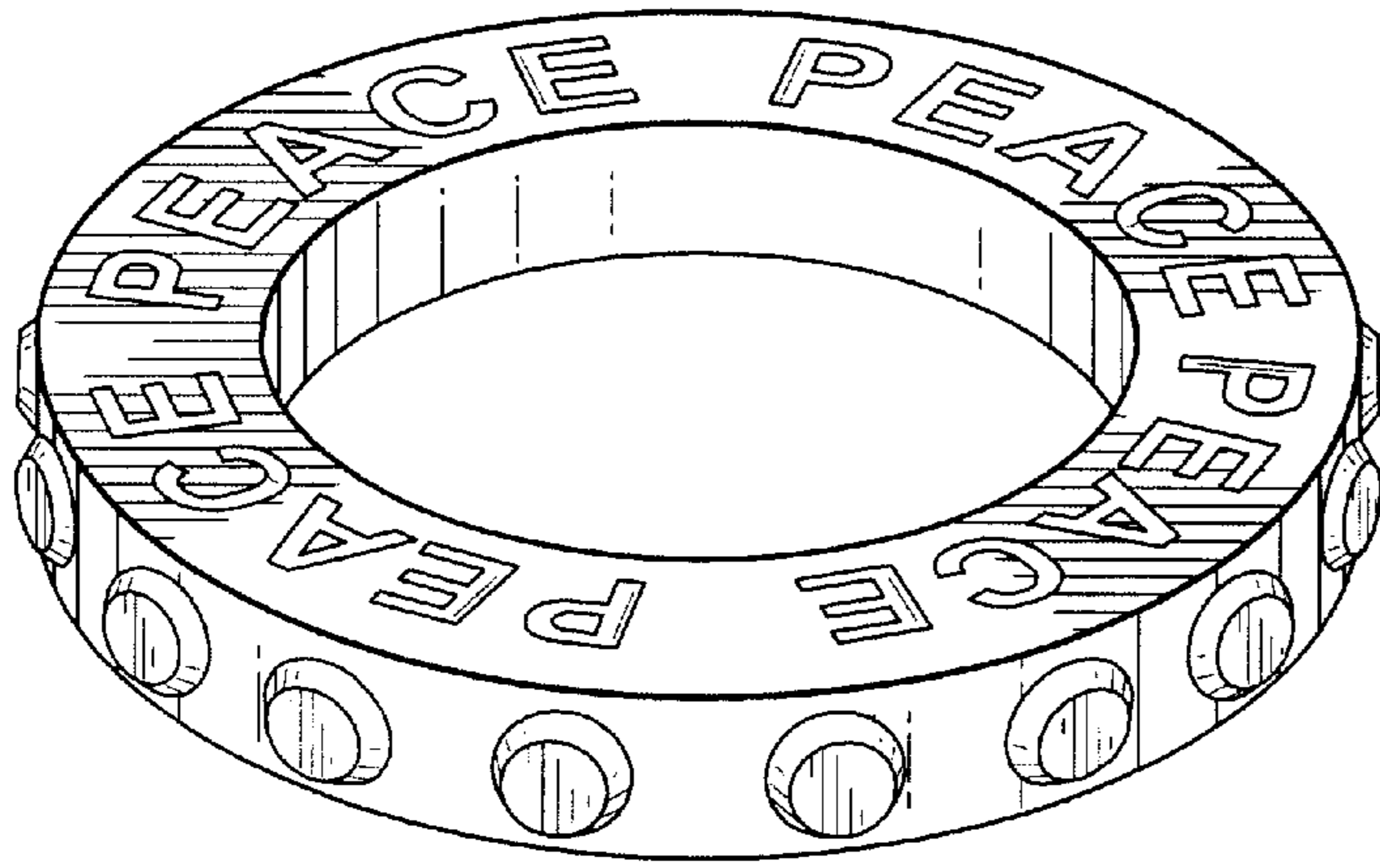

FIG. 85



FIG. 86

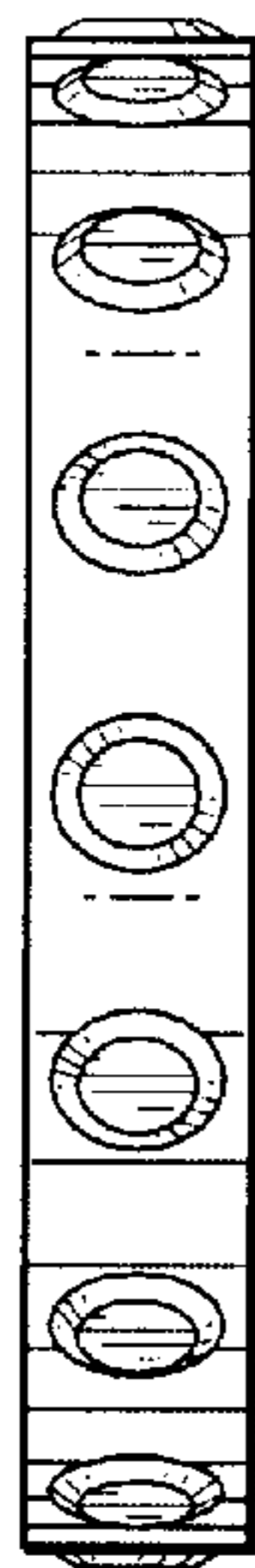

FIG. 87

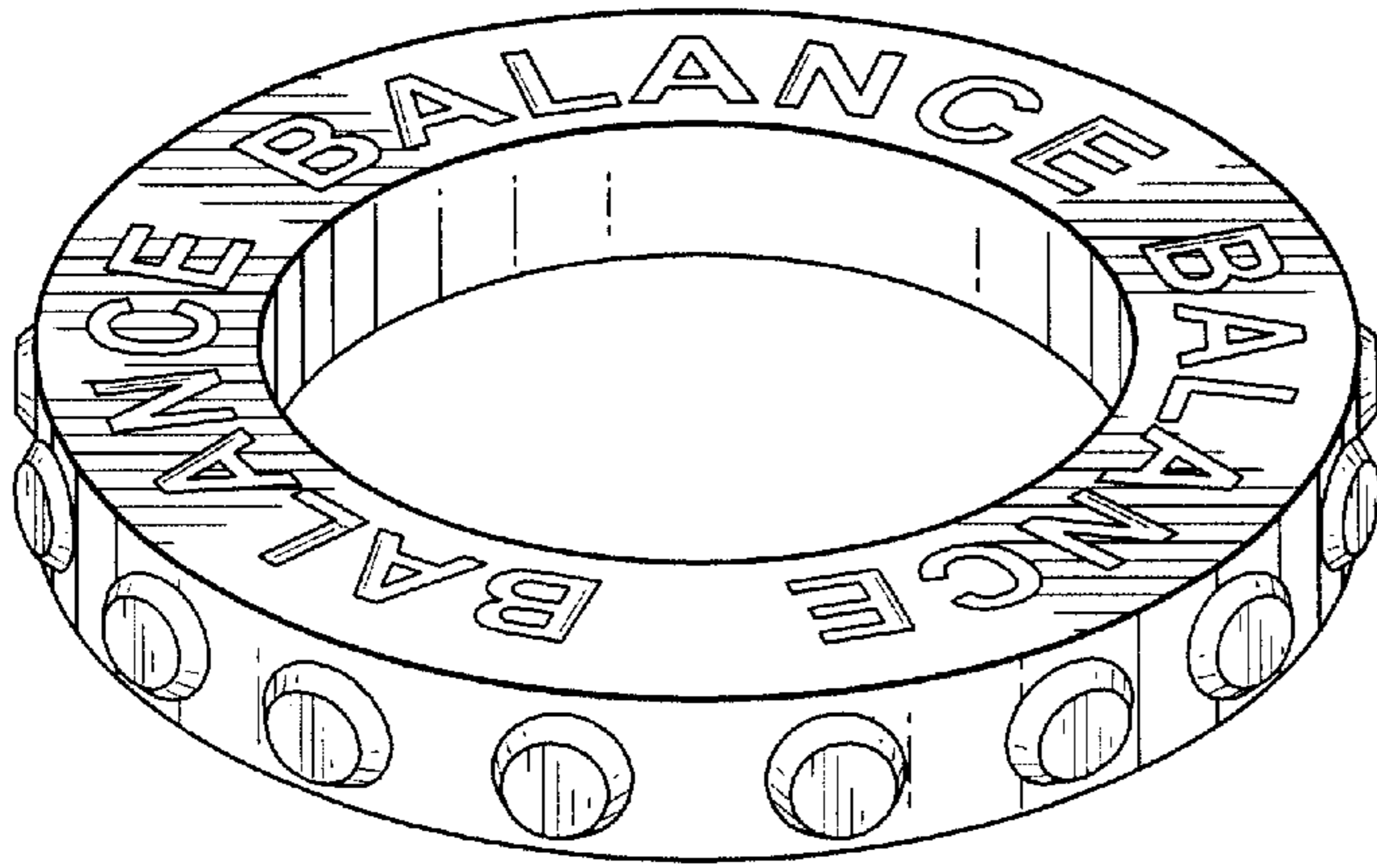

FIG. 88

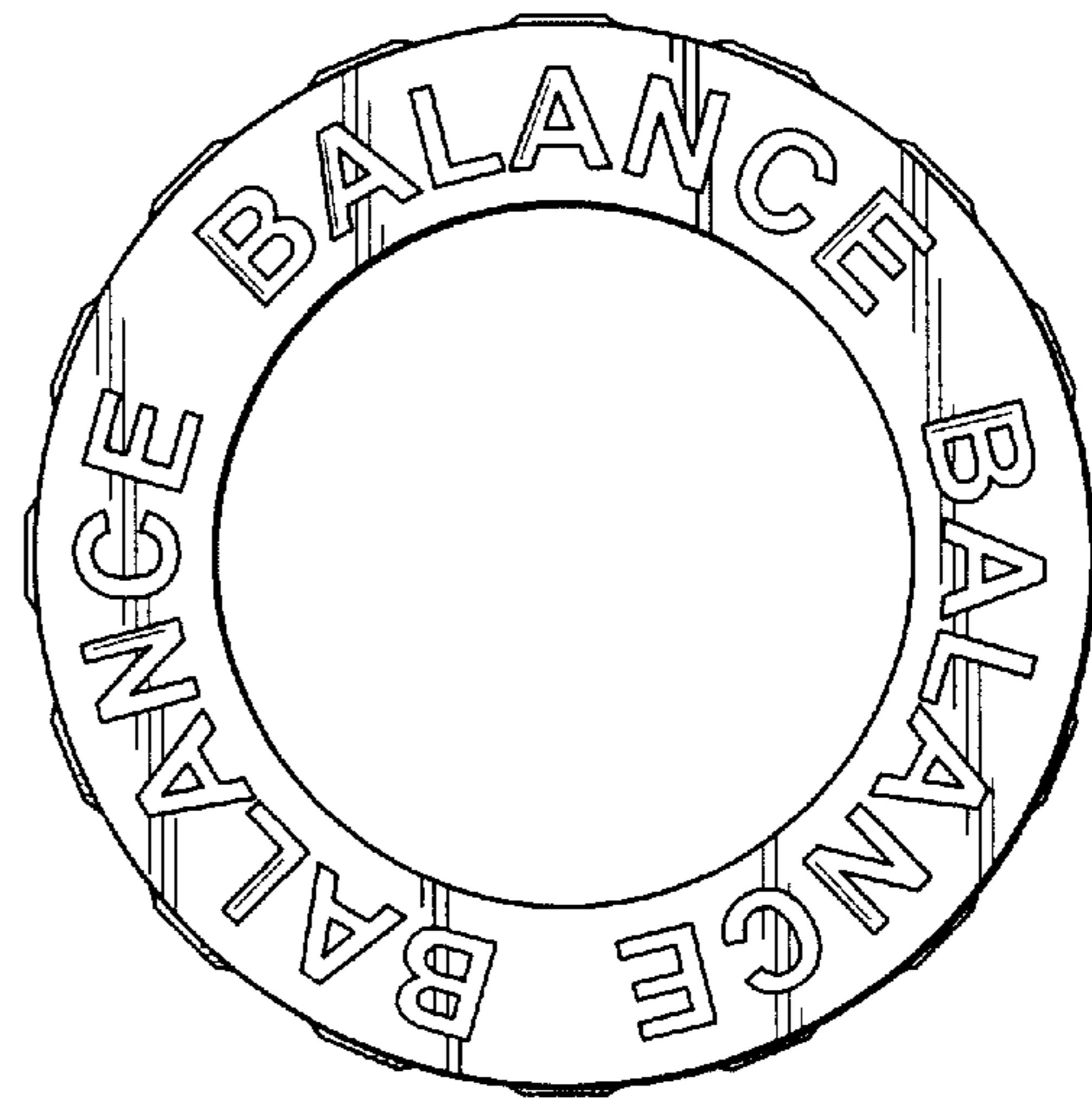

FIG. 89

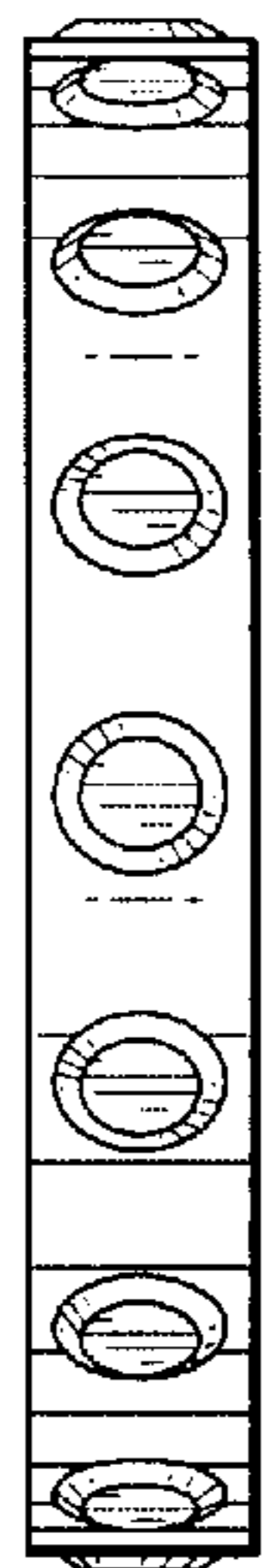

FIG. 90

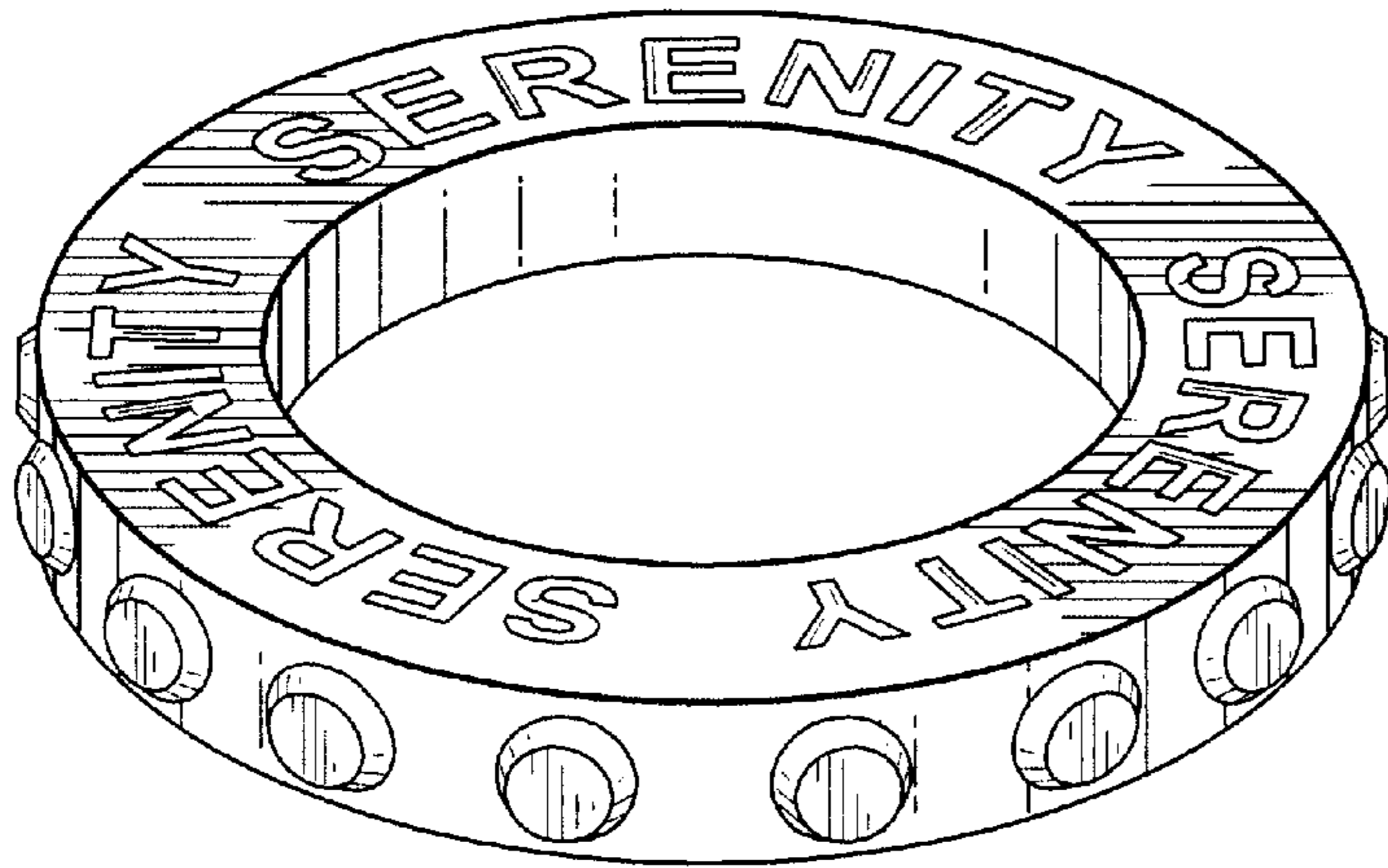

FIG. 91

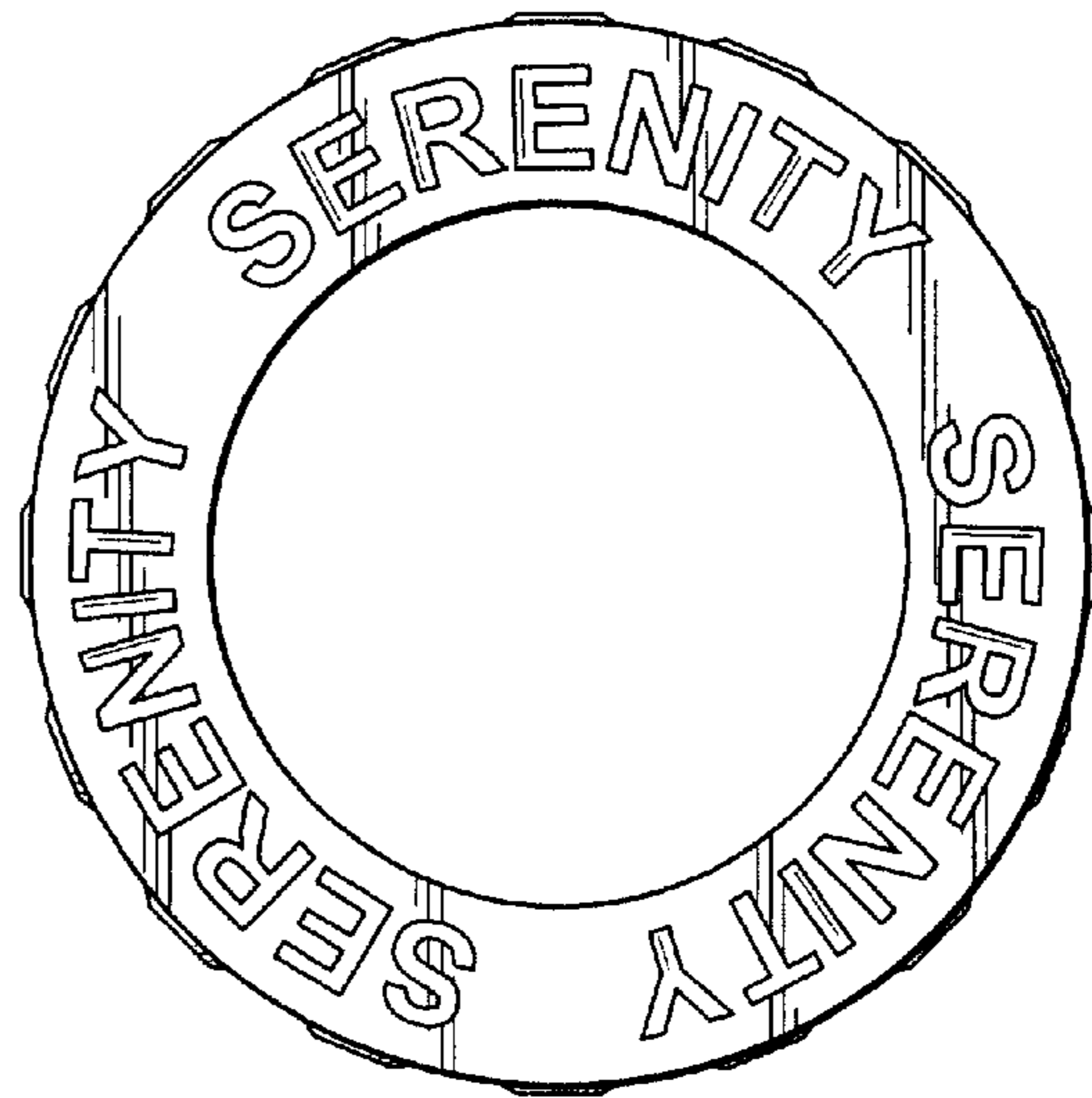

FIG. 92

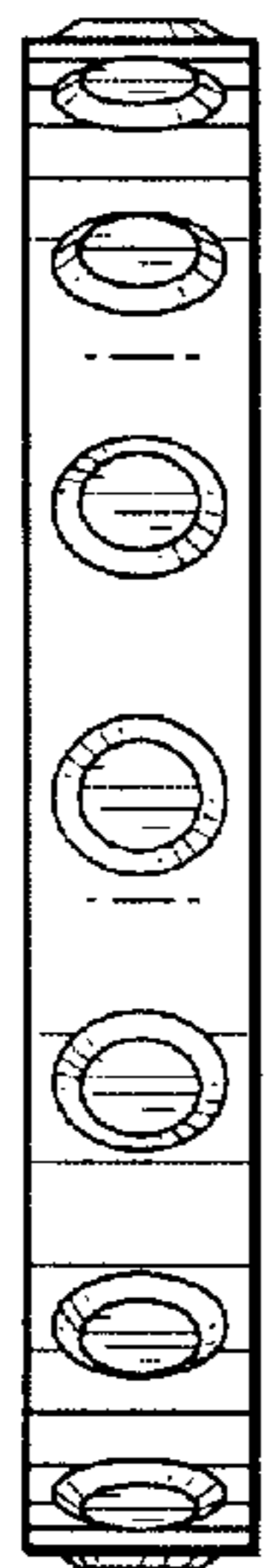

FIG. 93

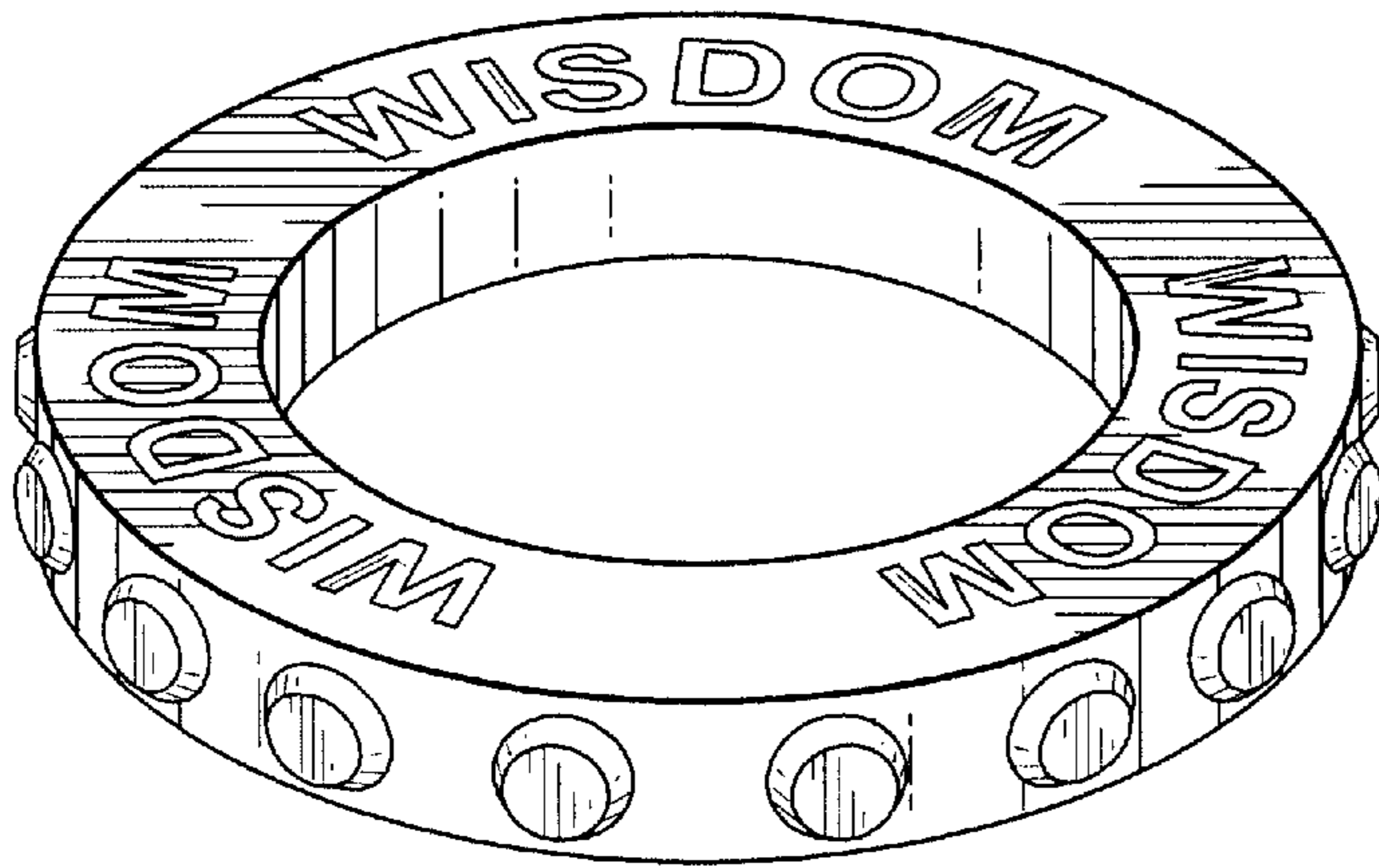

FIG. 94

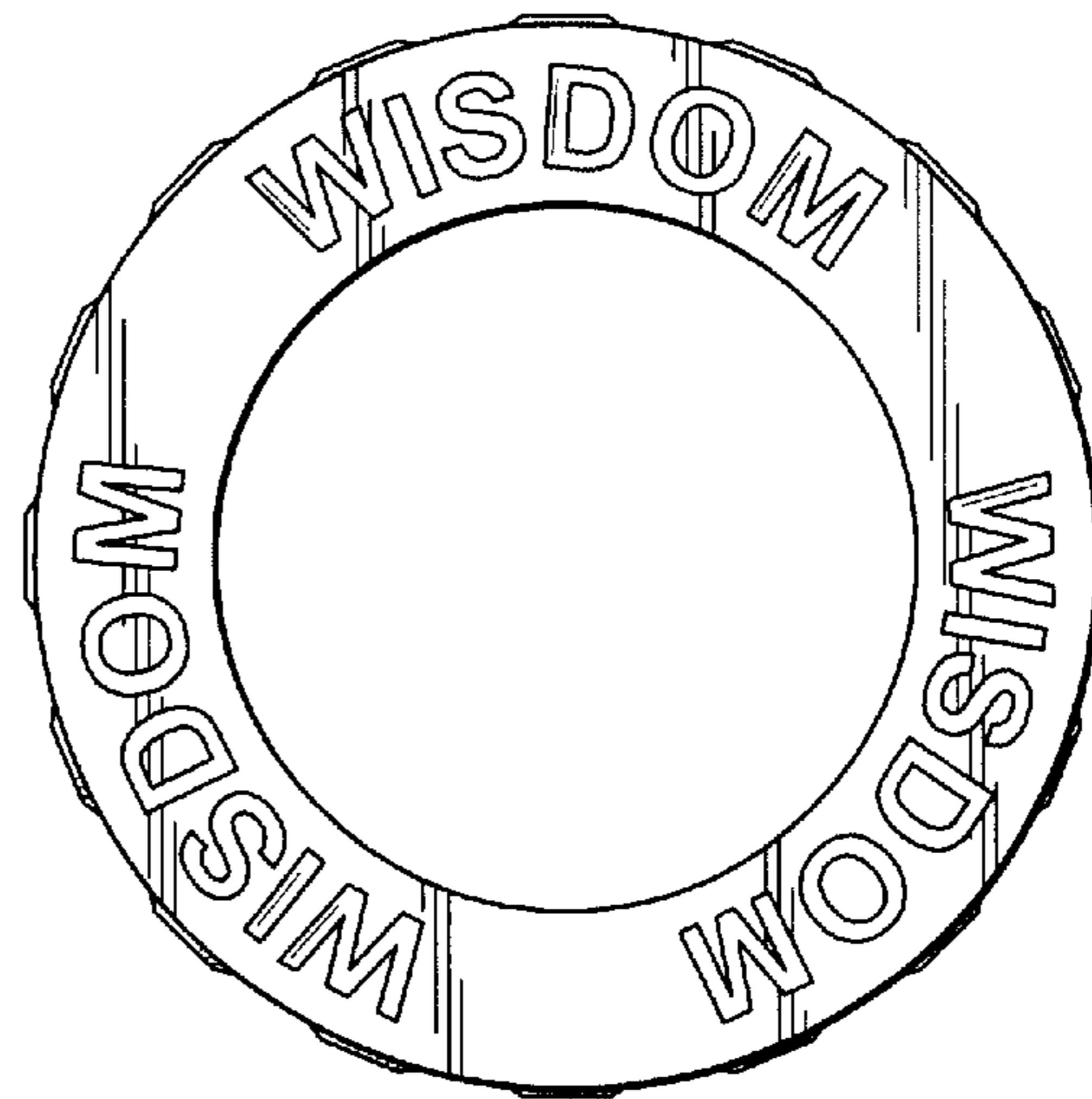

FIG. 95

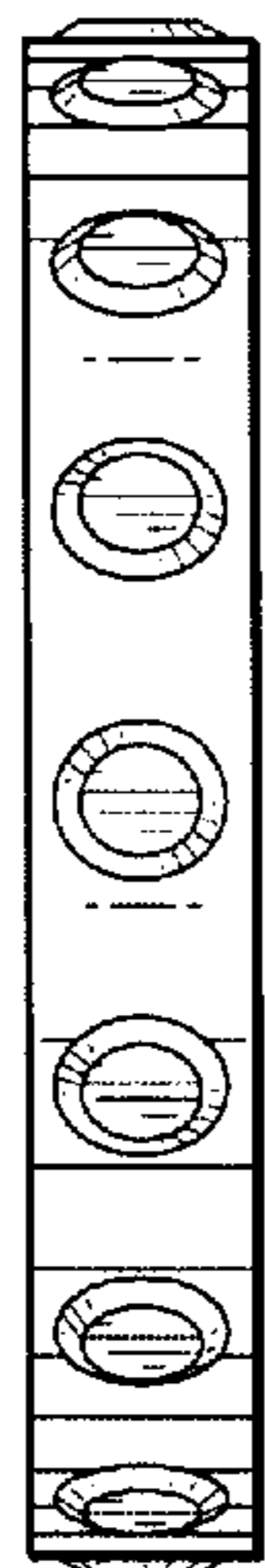

FIG. 96

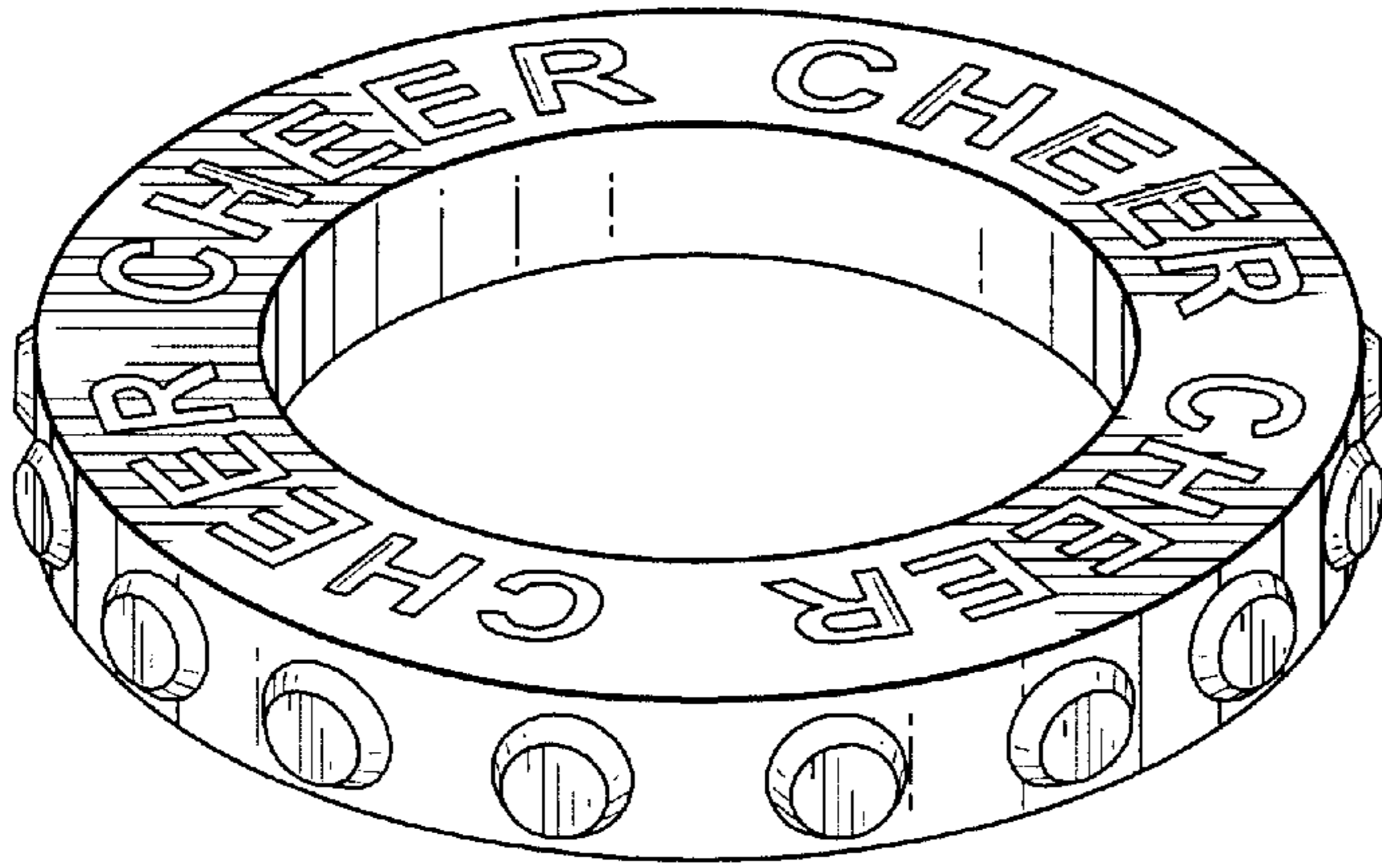

FIG. 97

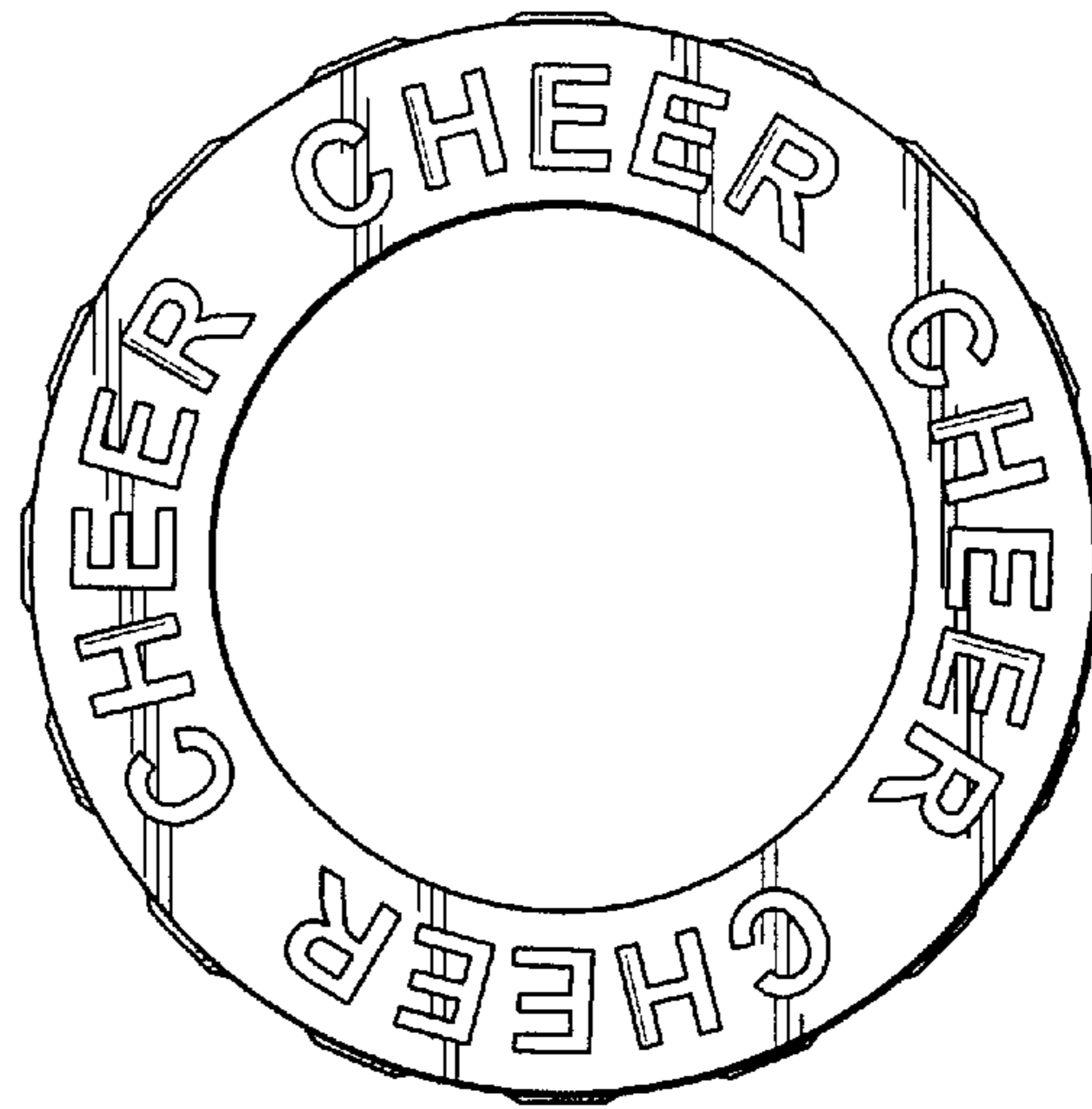

FIG. 98

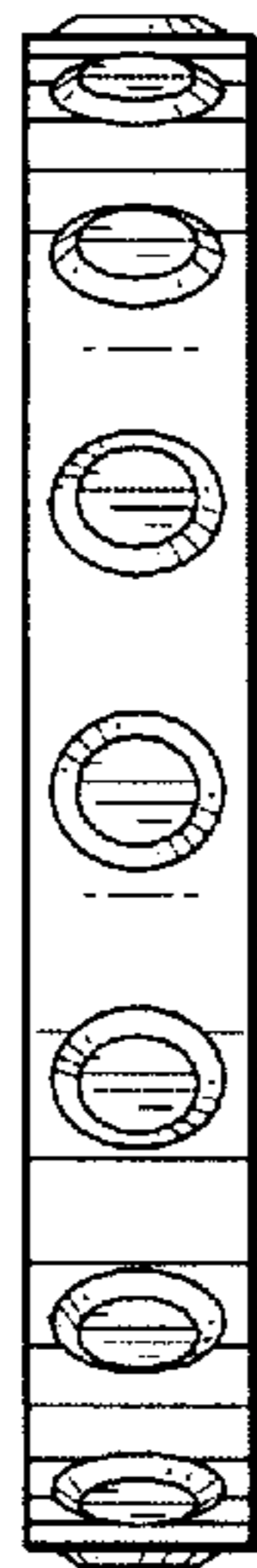

FIG. 99

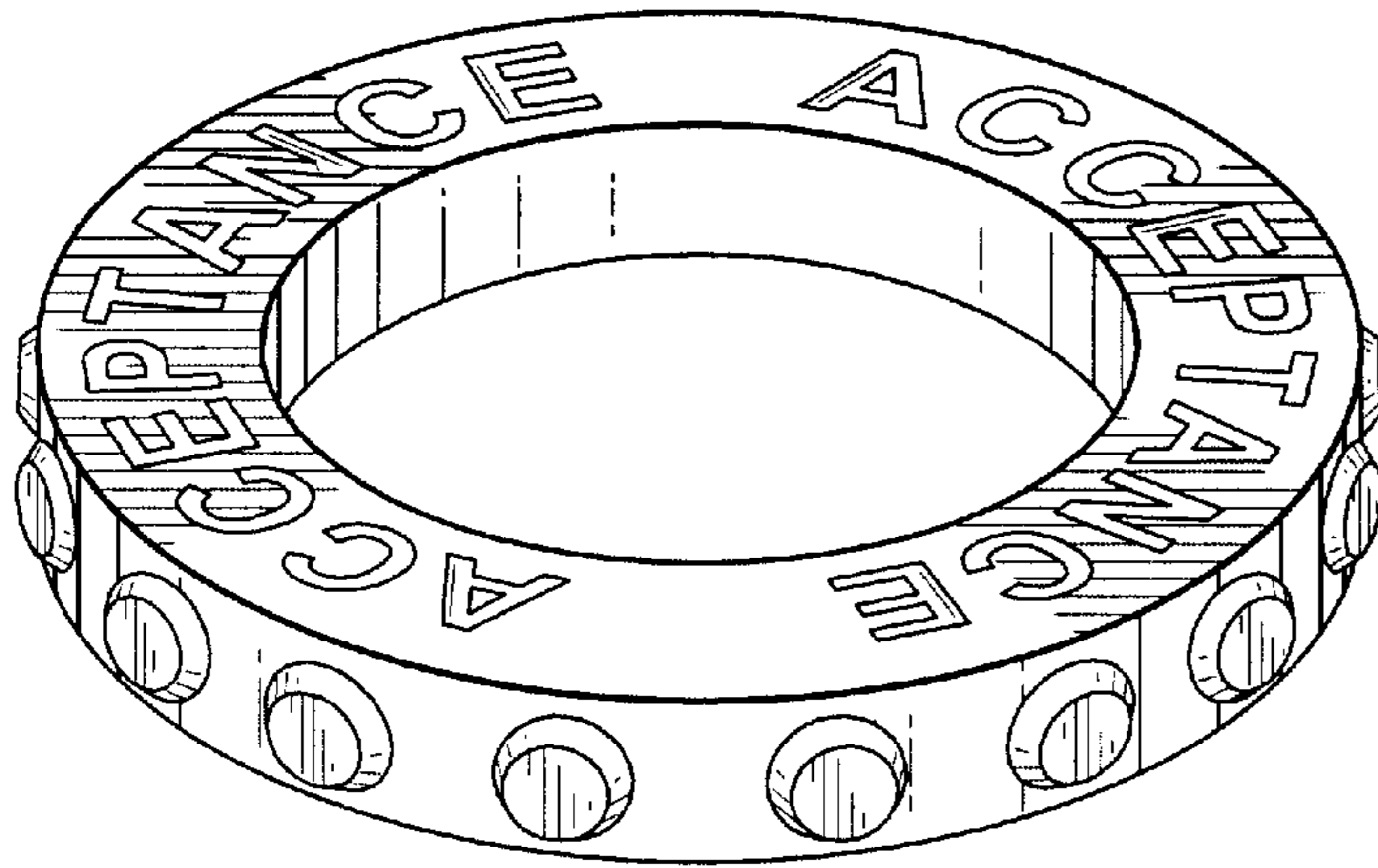

FIG. 100



FIG. 101

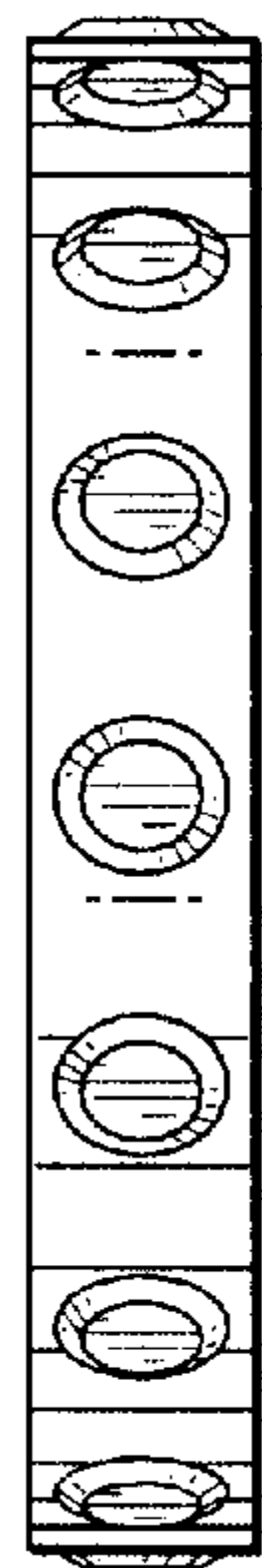

FIG. 102

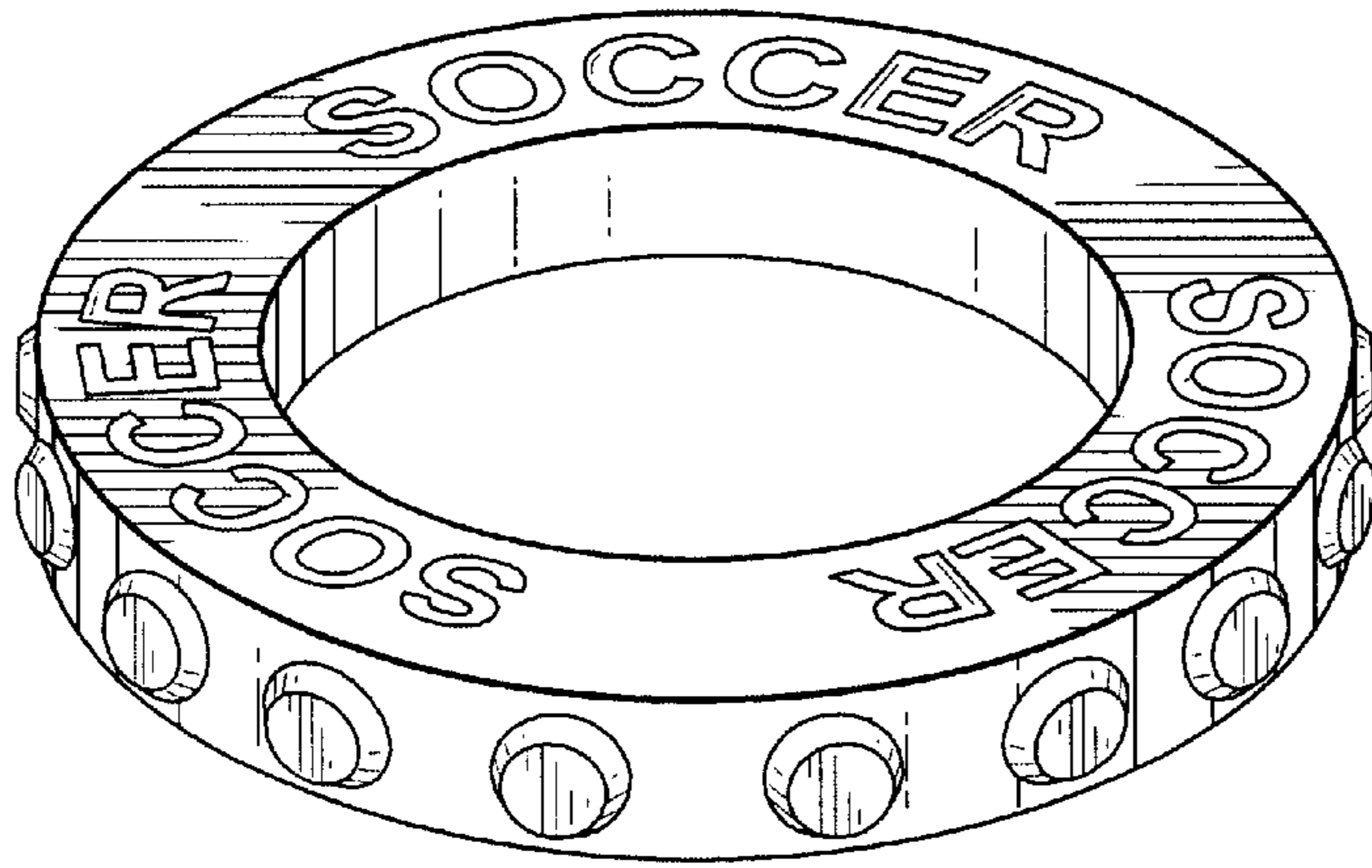

FIG. 103

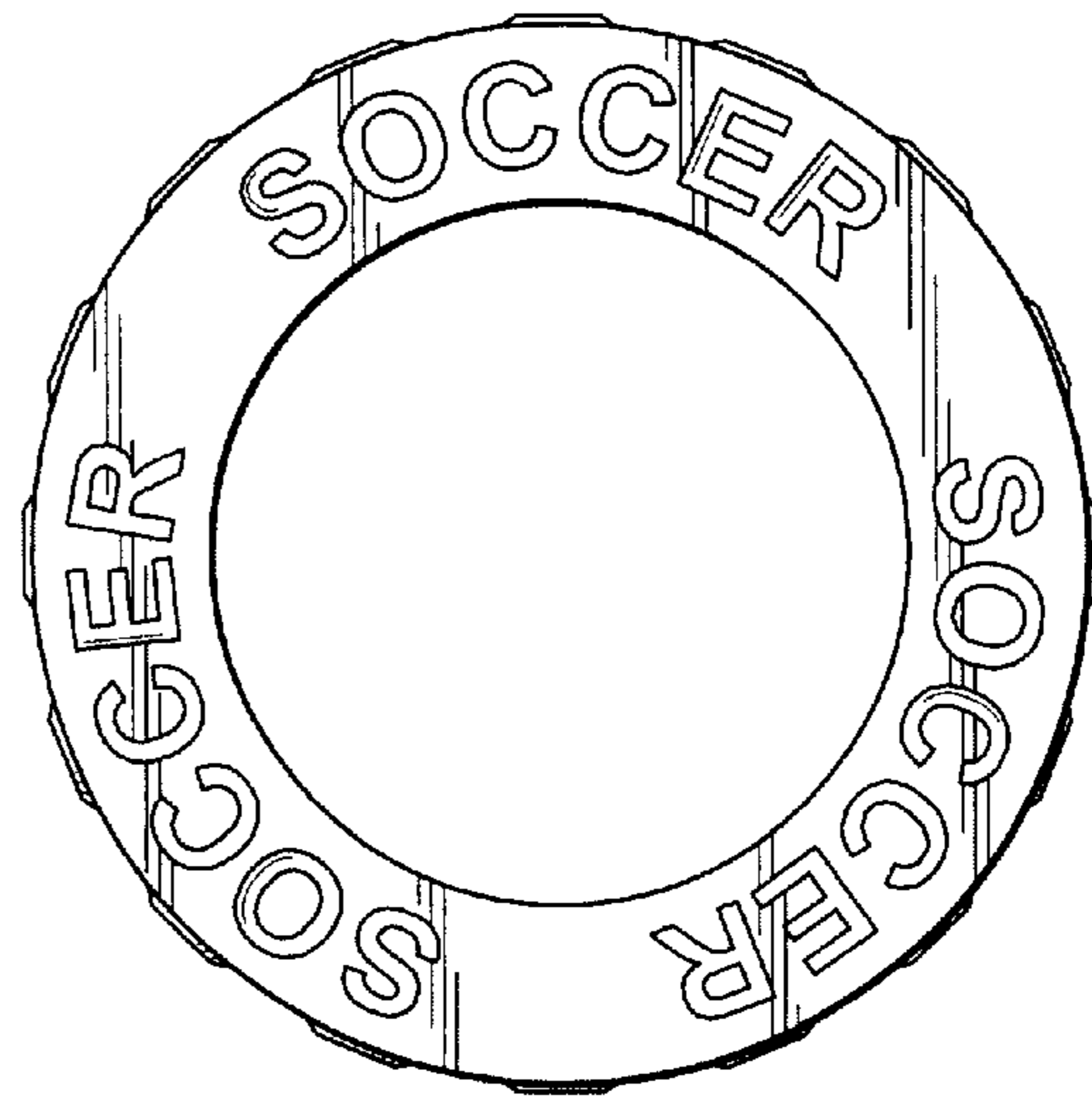

FIG. 104

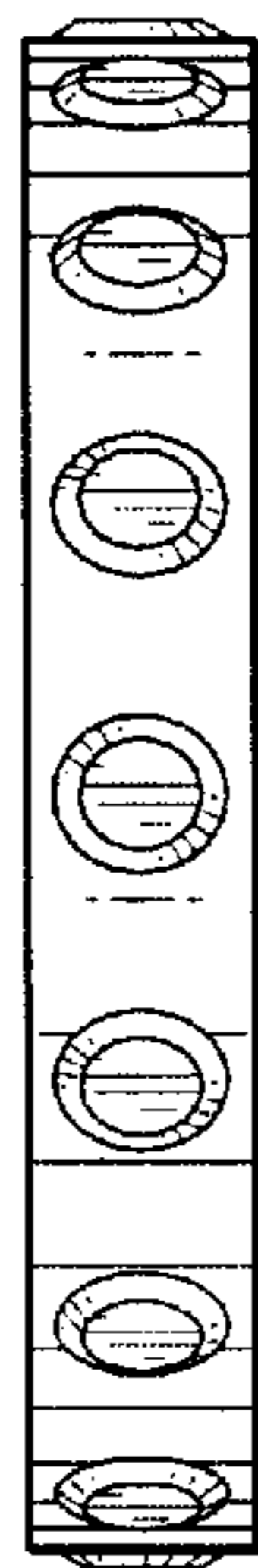

FIG. 105

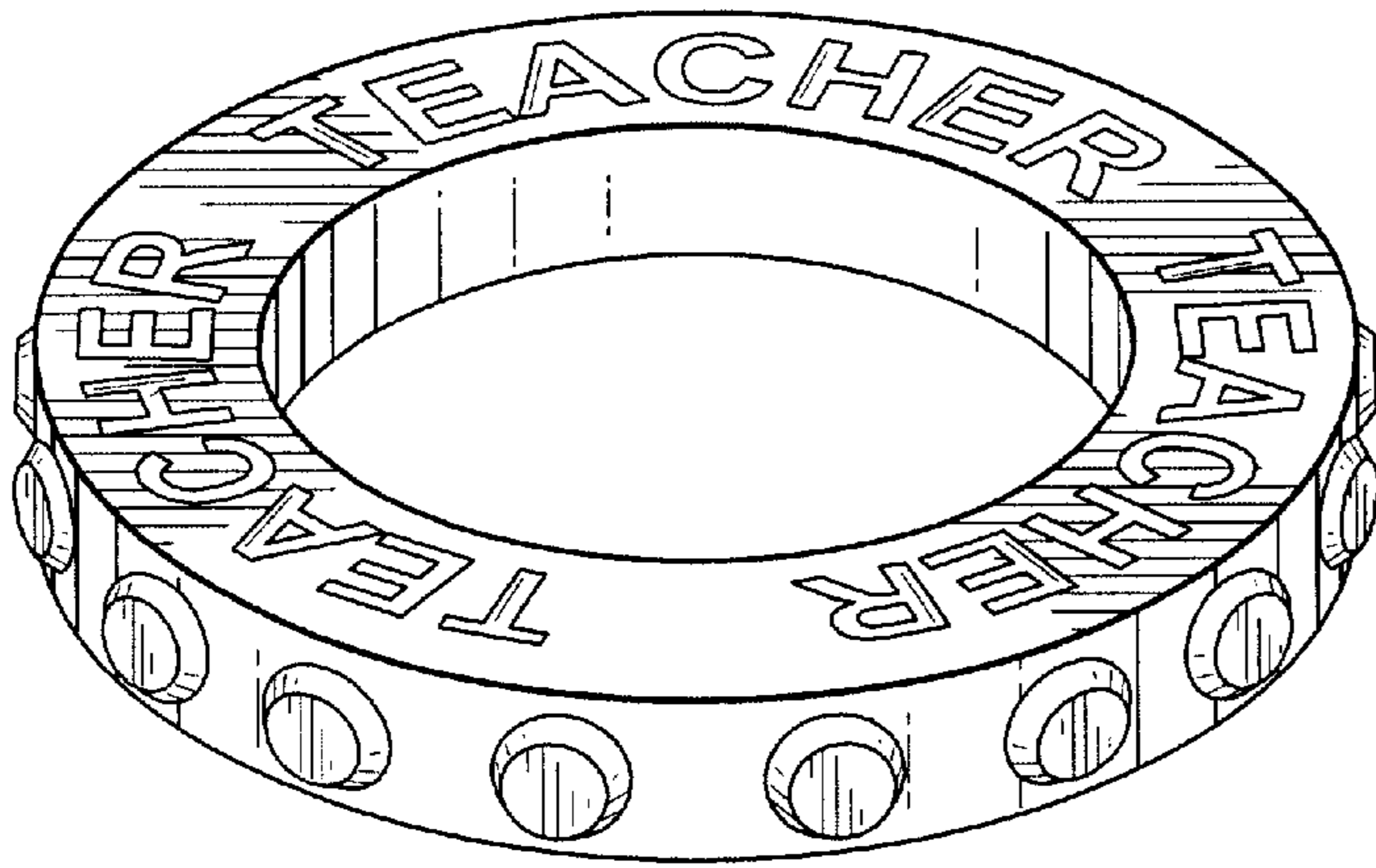

FIG. 106

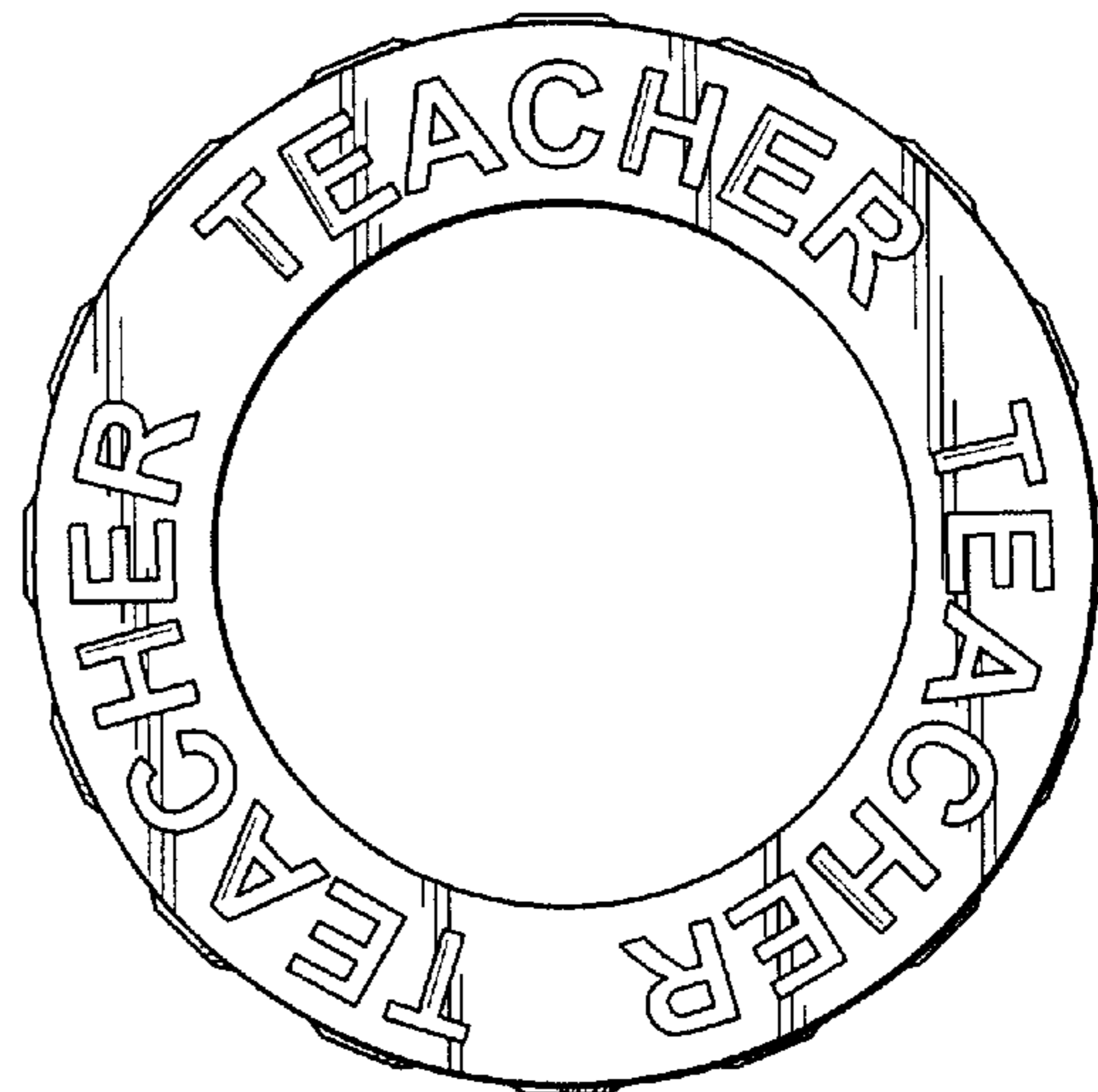

FIG. 107

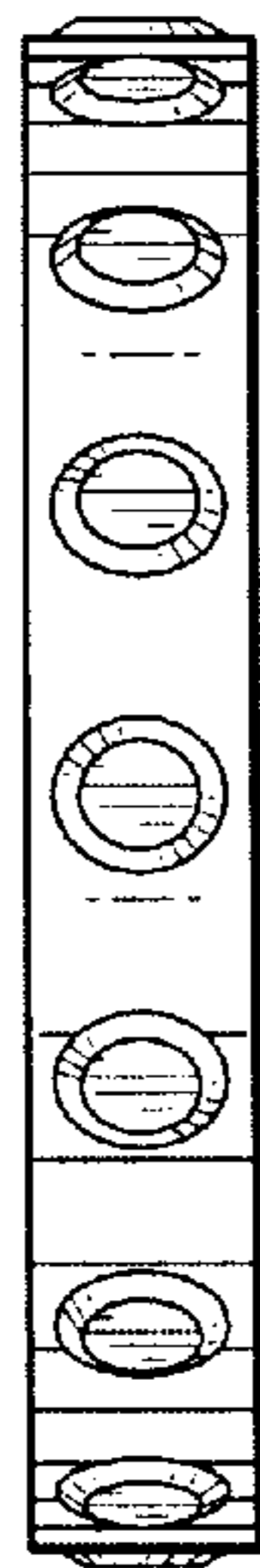

FIG. 108

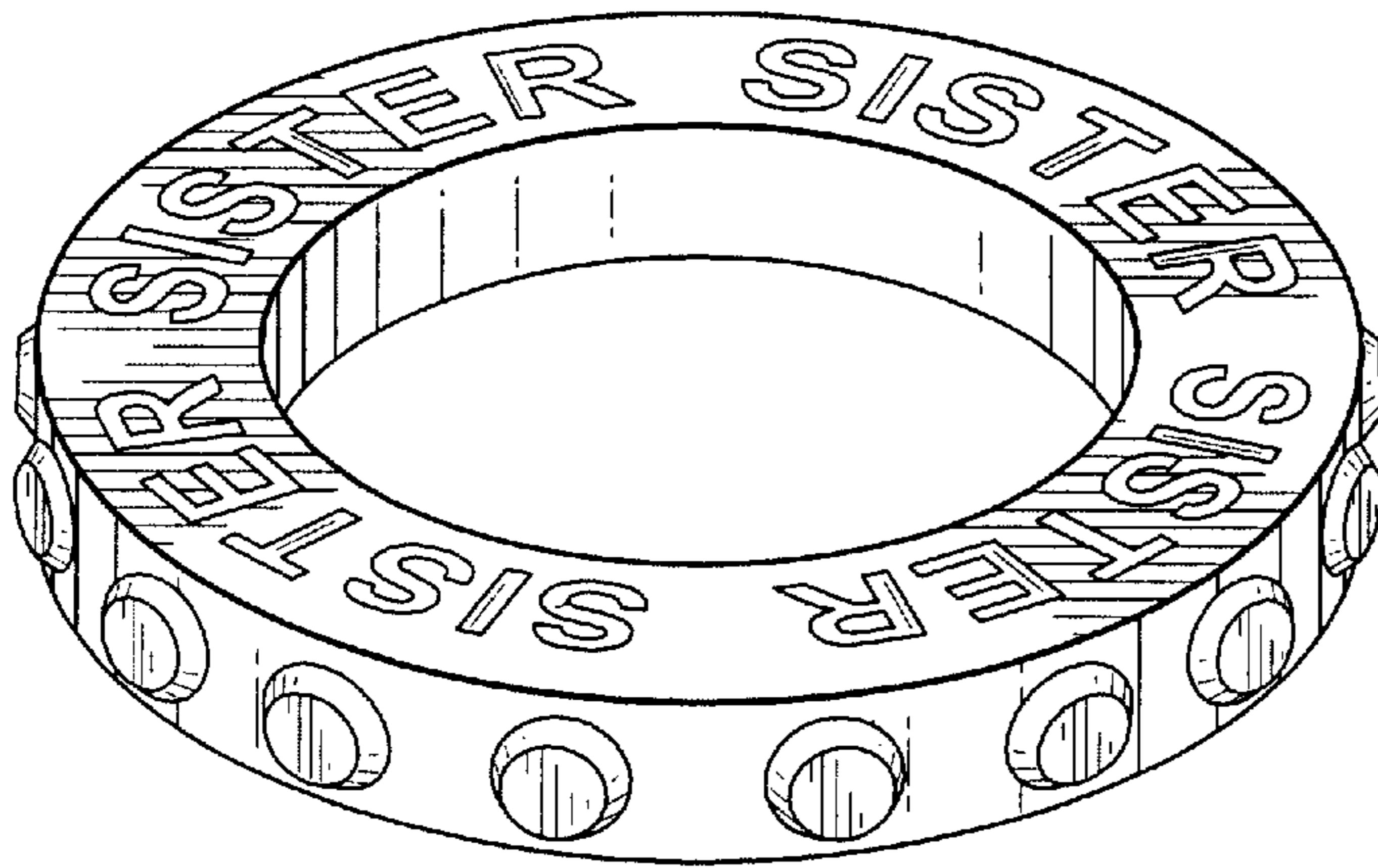

FIG. 109



FIG. 110

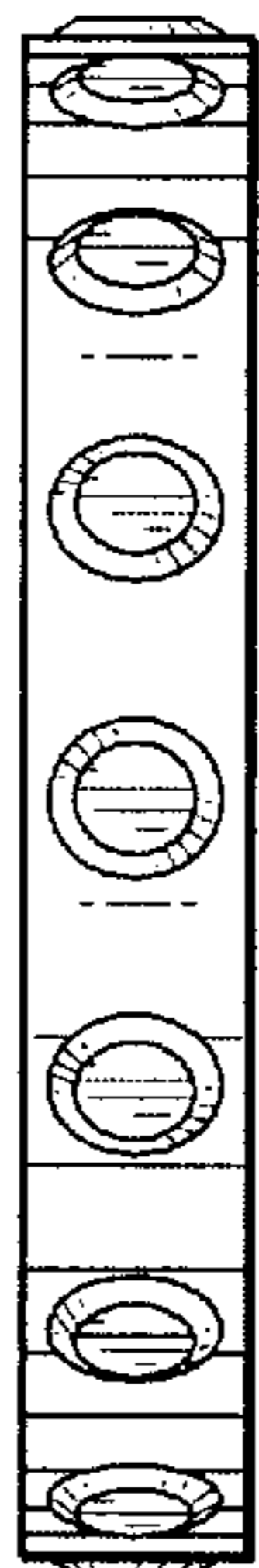

FIG. 111

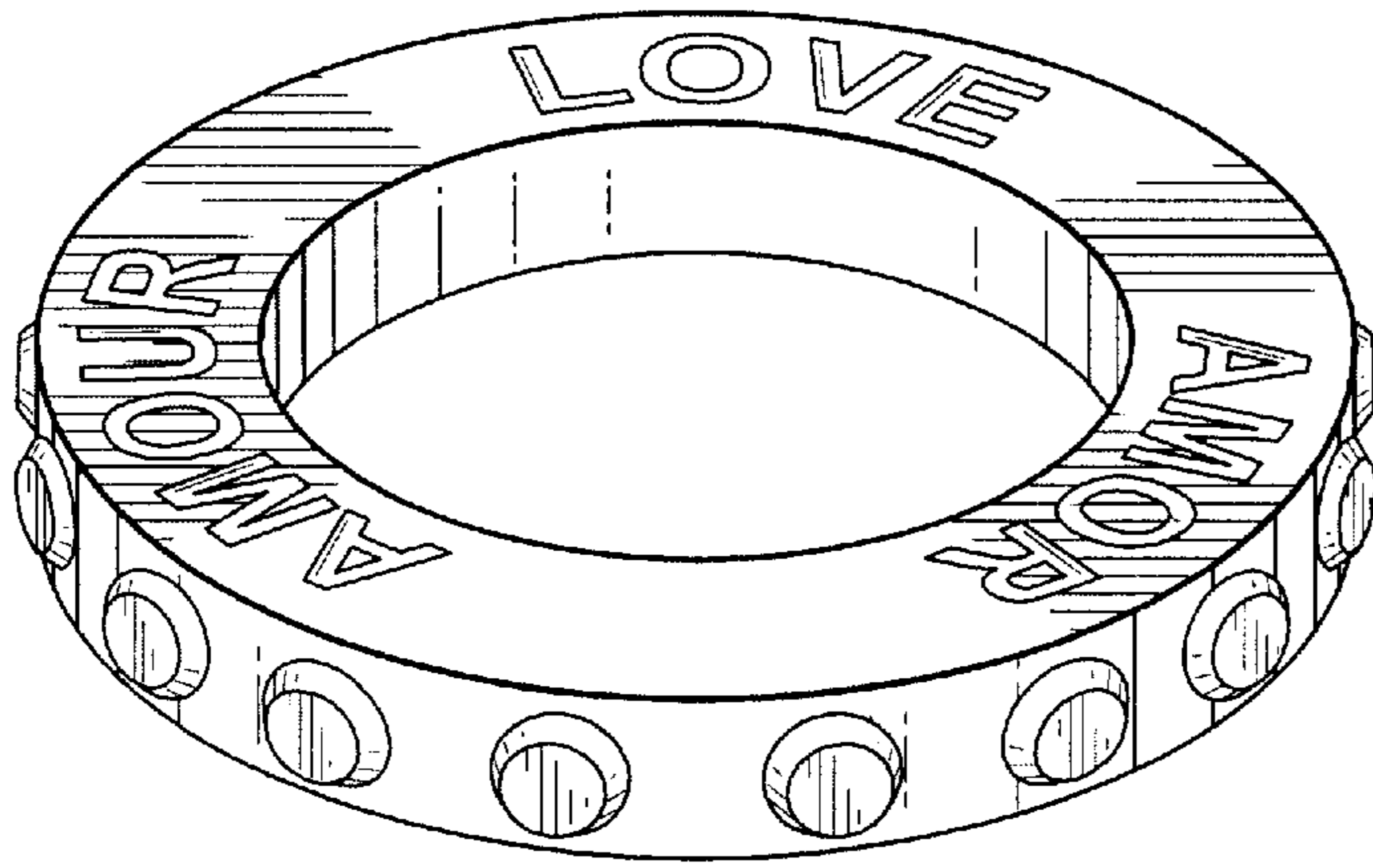

FIG. 112

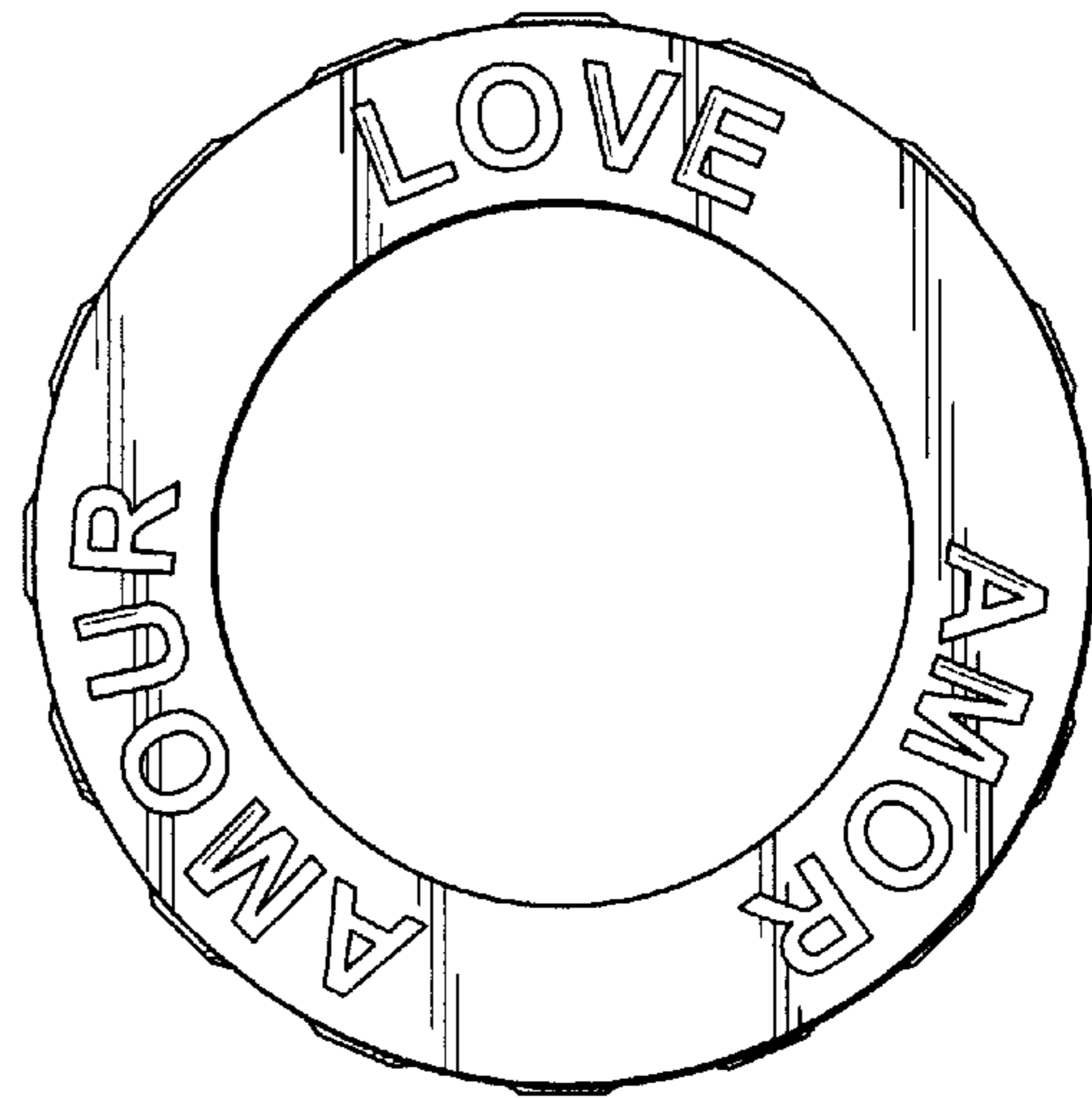

FIG. 113

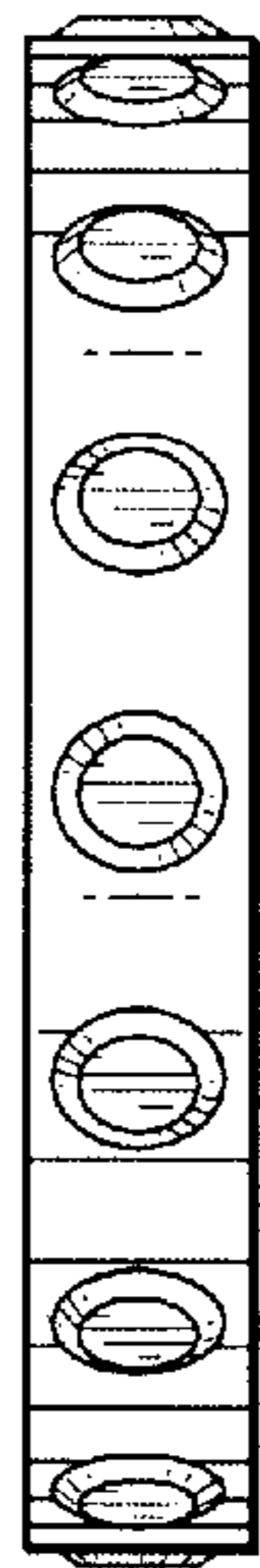

FIG. 114

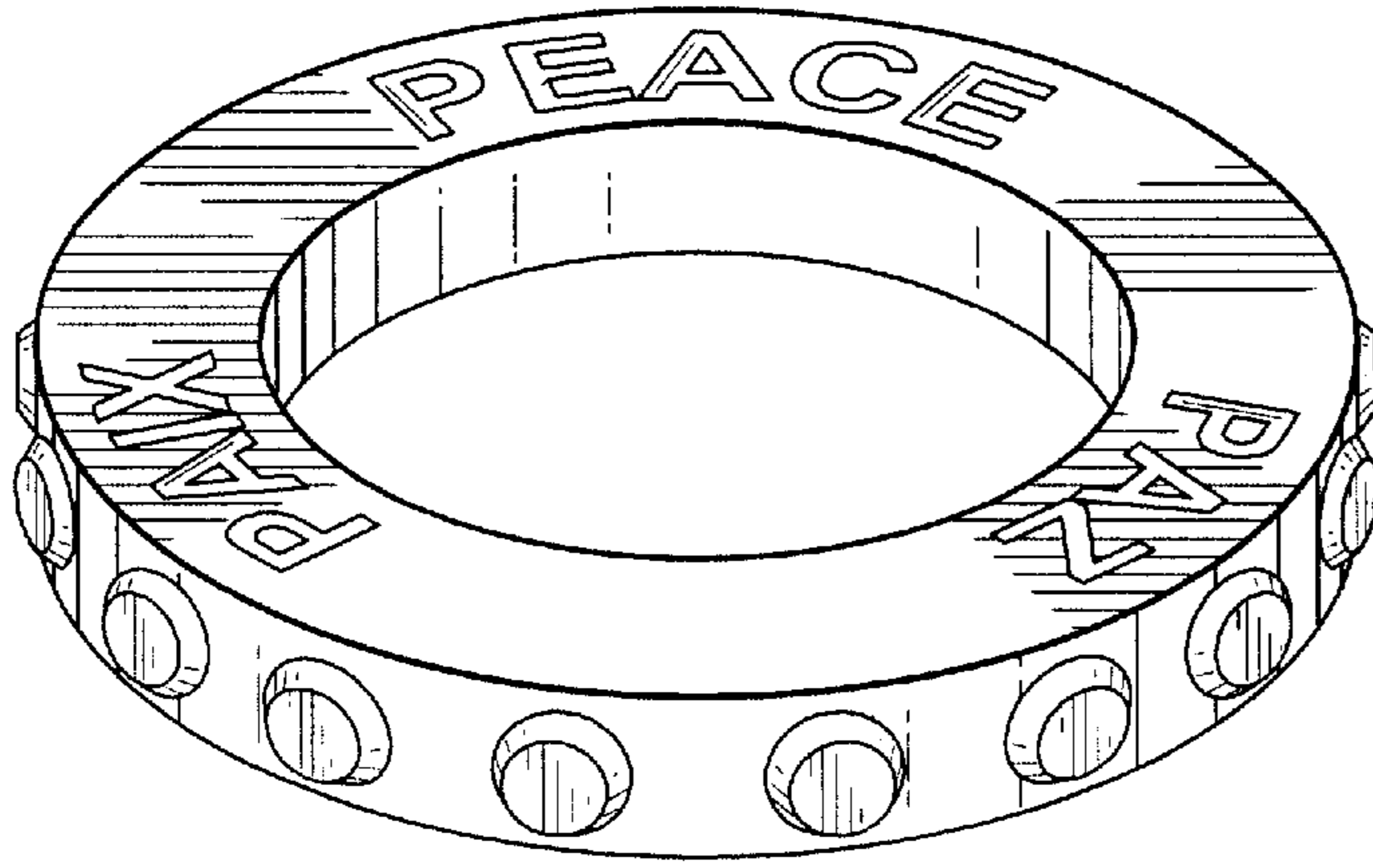

FIG. 115



FIG. 116

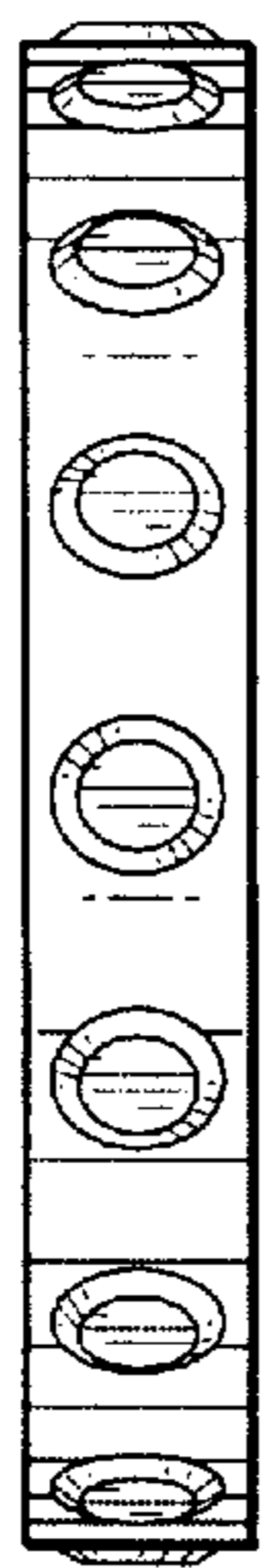

FIG. 117

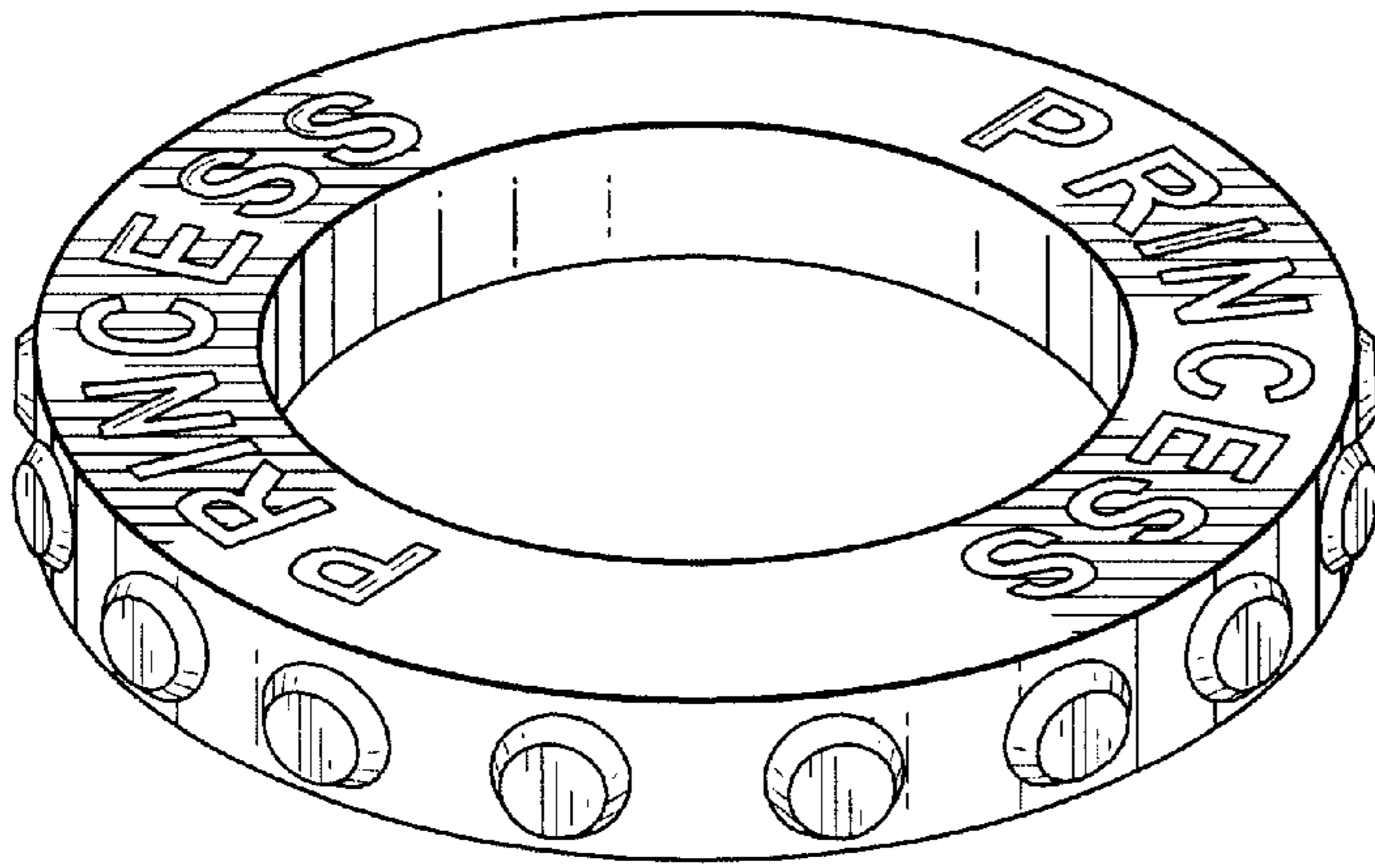

FIG. 118

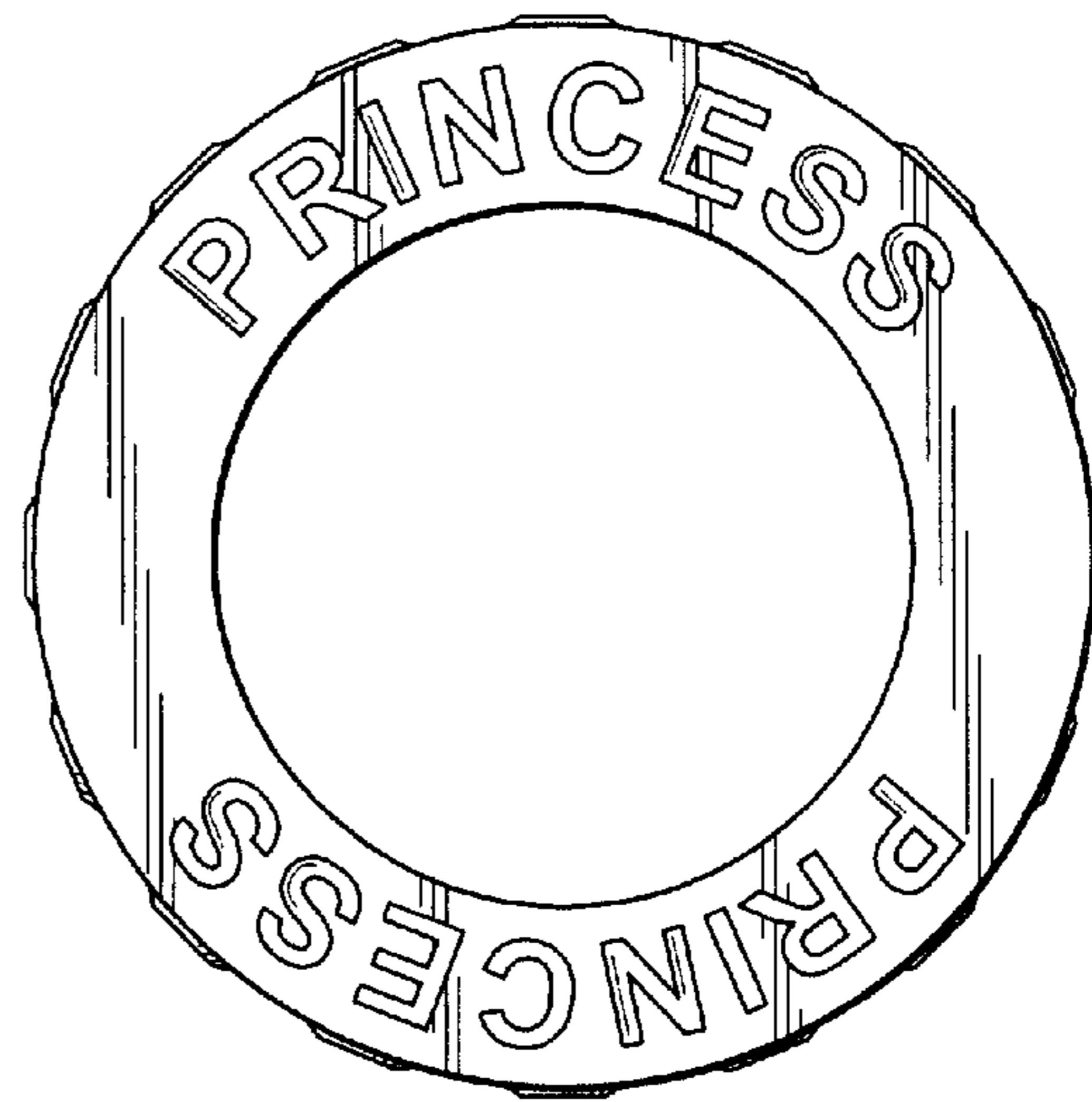

FIG. 119

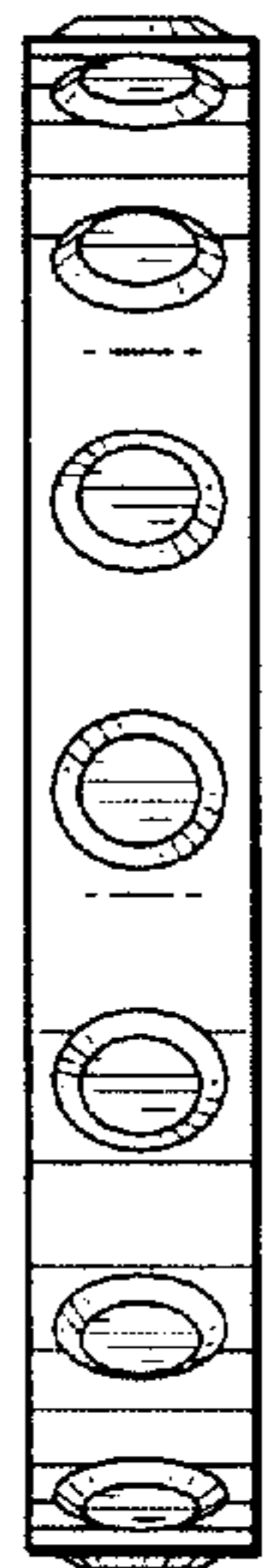

FIG. 120

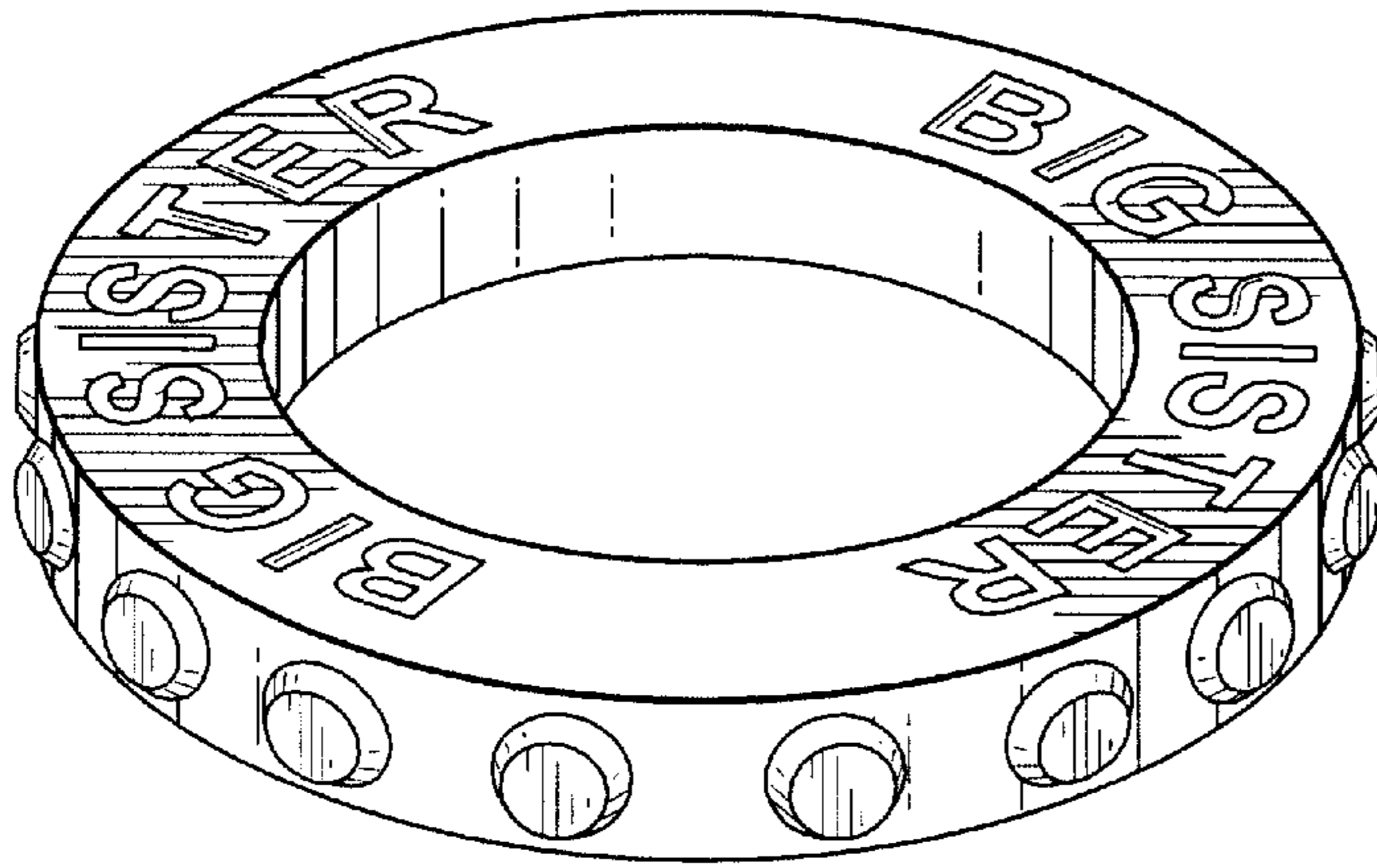

FIG. 121



FIG. 122

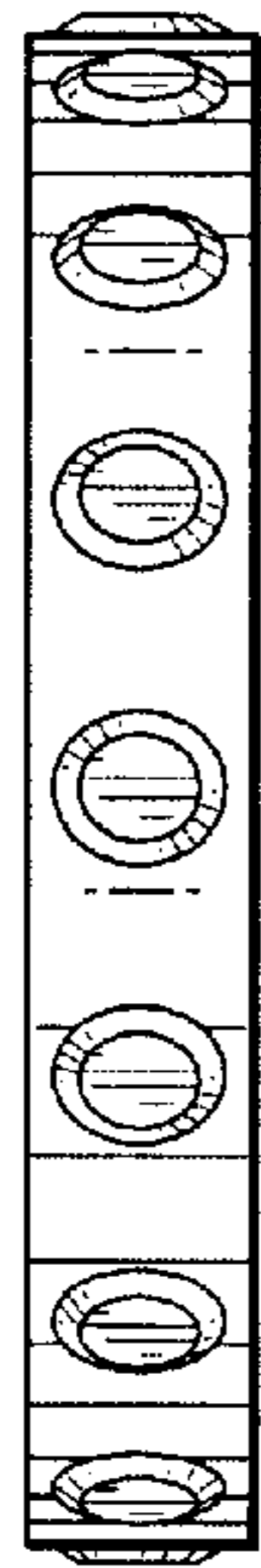

FIG. 123

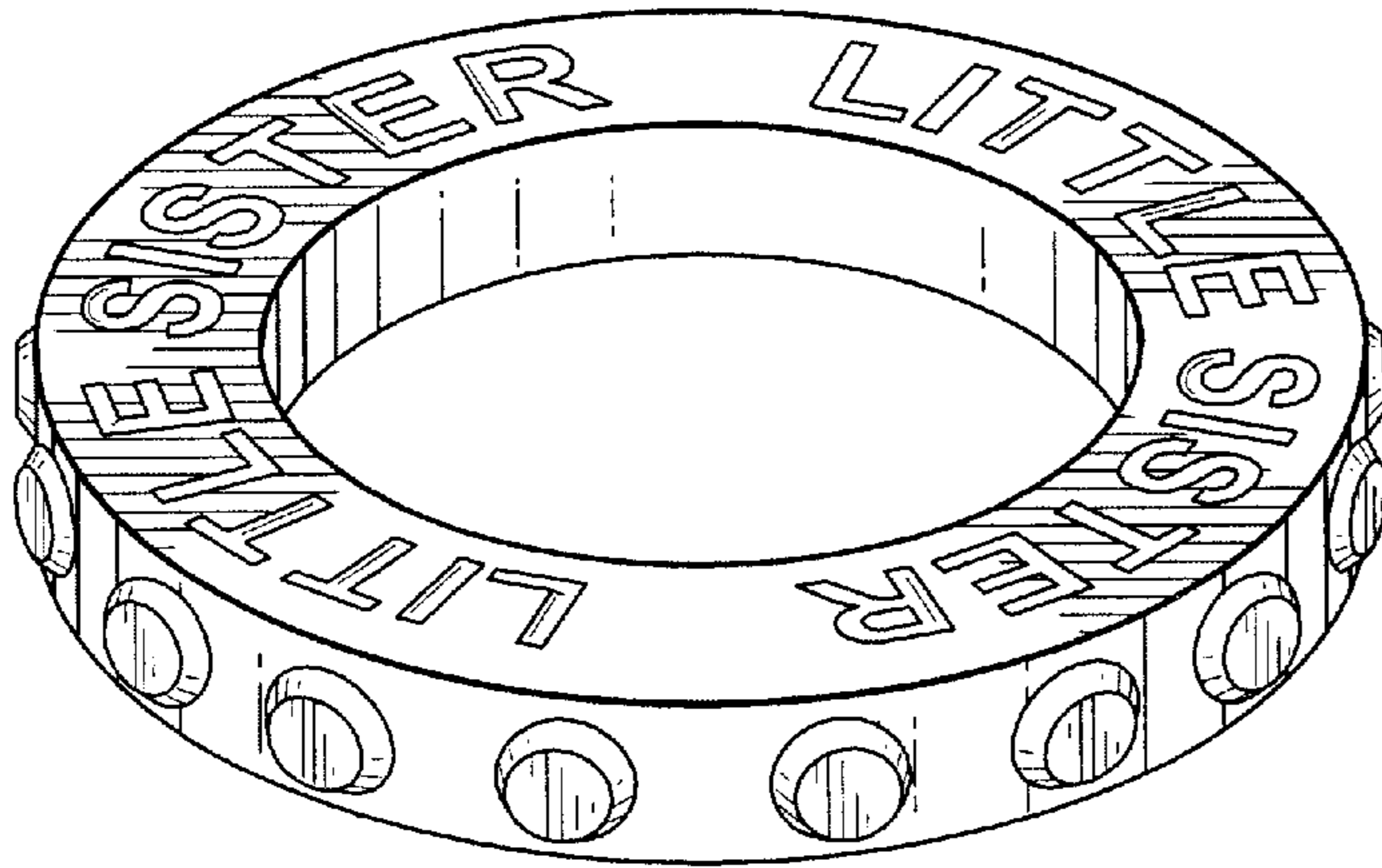

FIG. 124

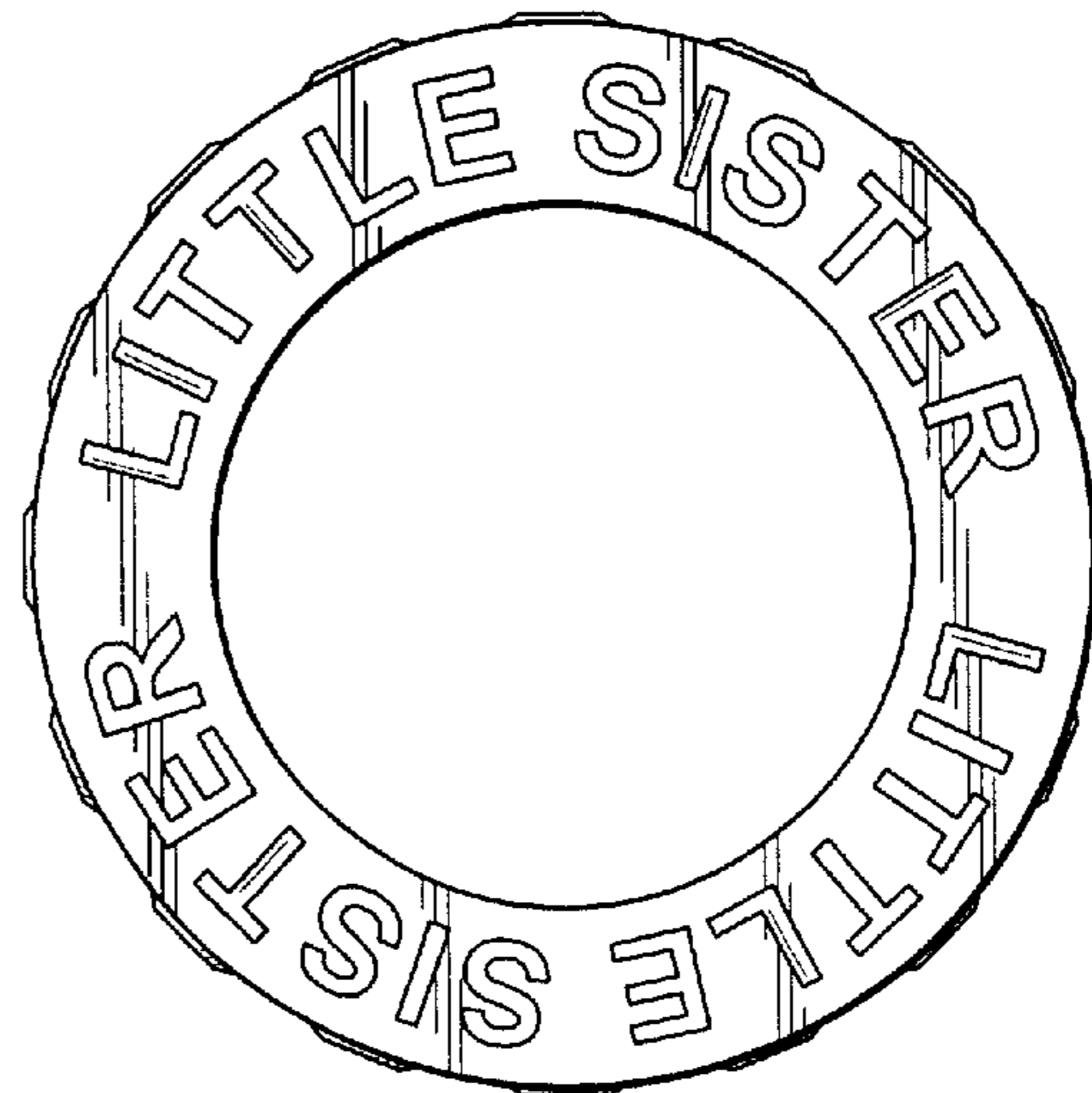

FIG. 125

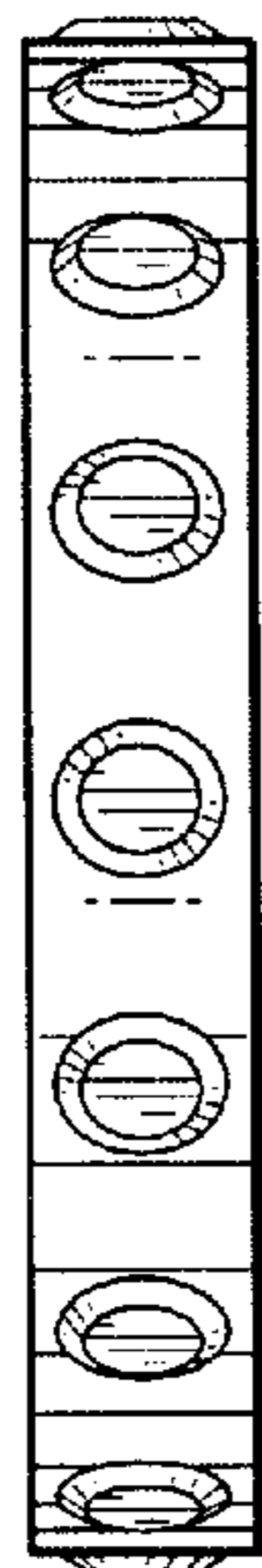

FIG. 126

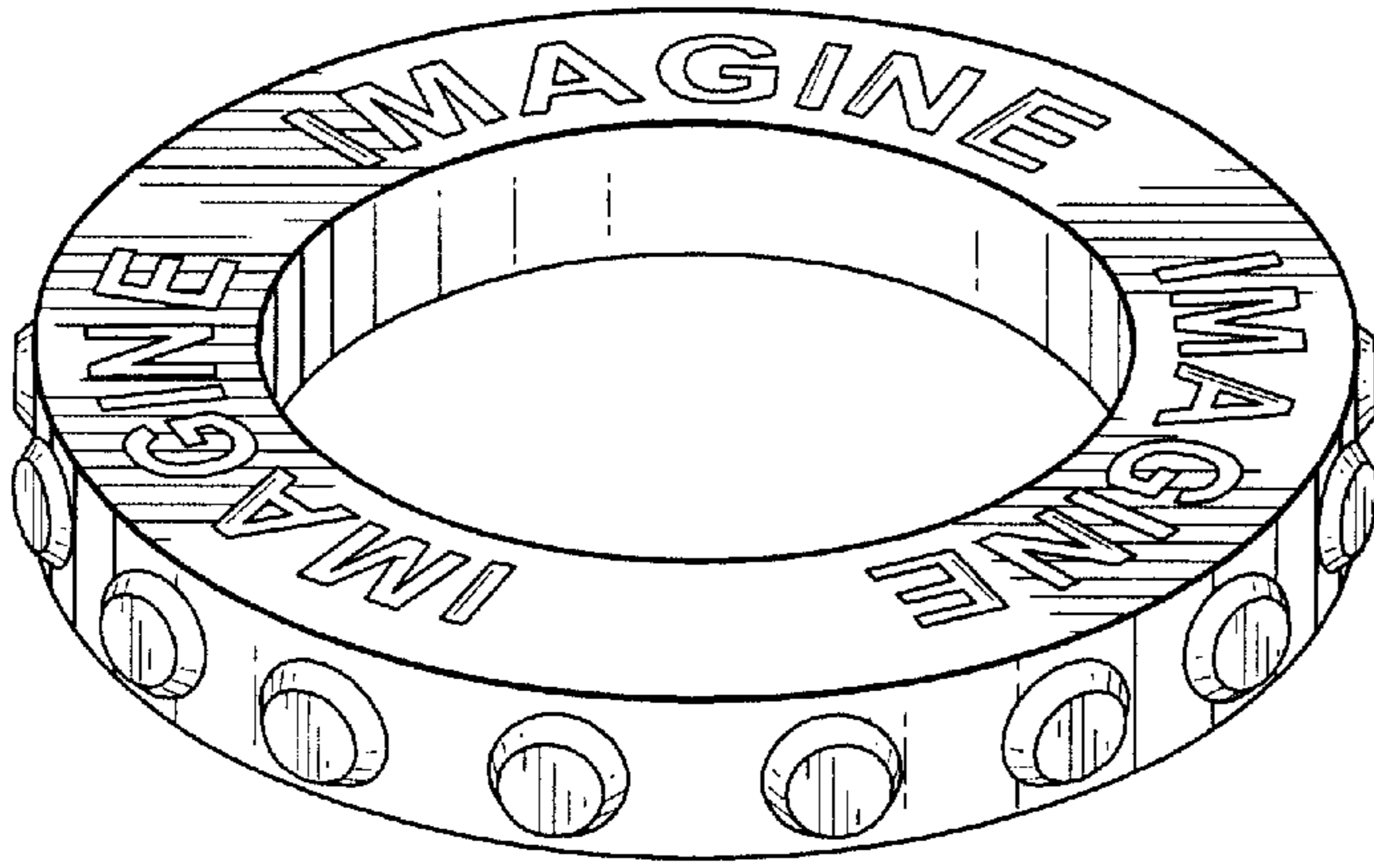

FIG. 127

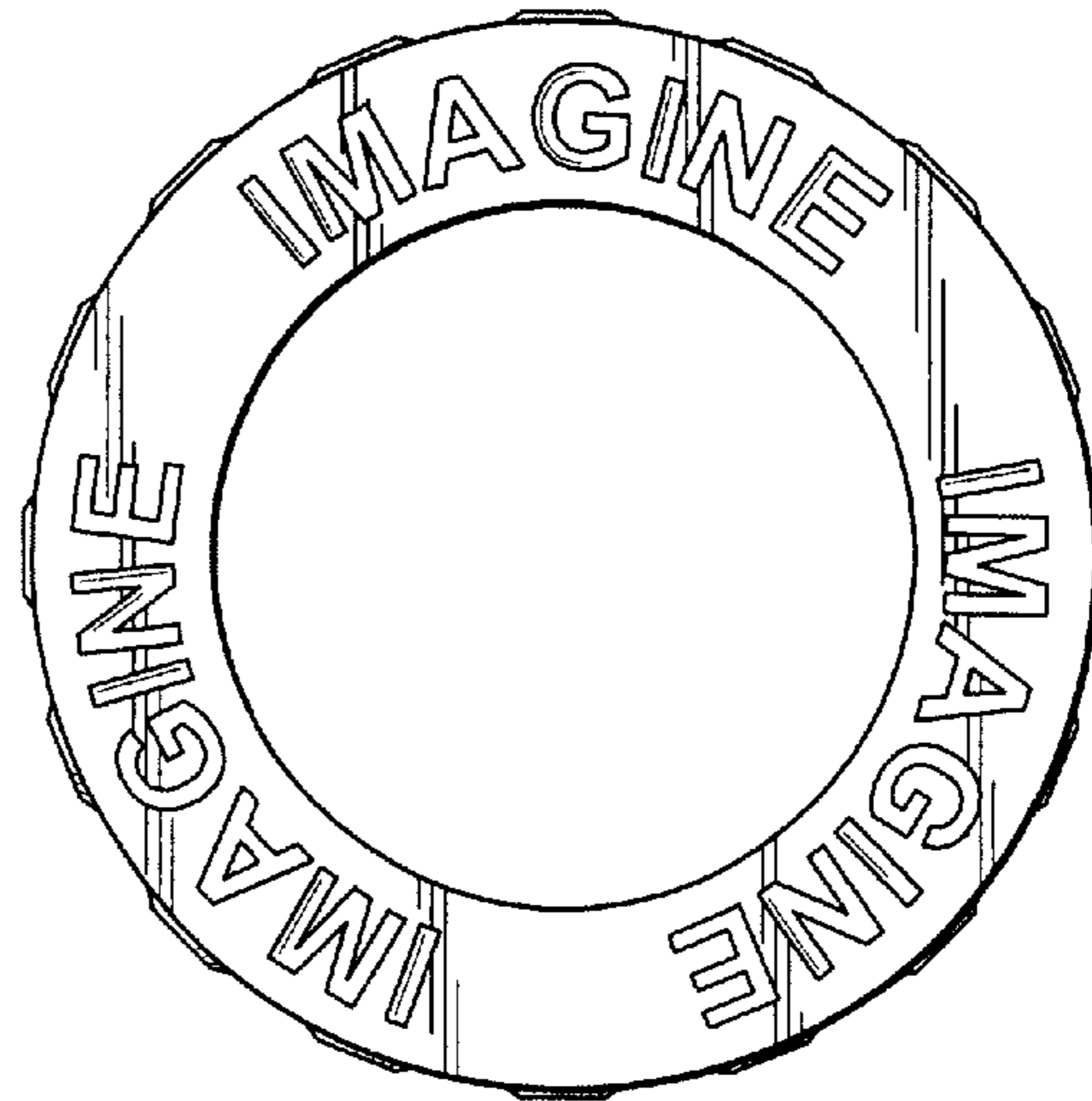

FIG. 128

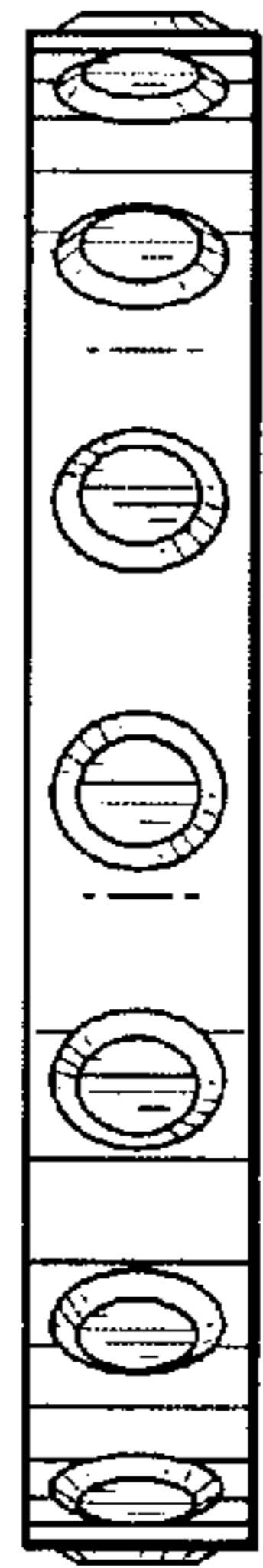

FIG. 129

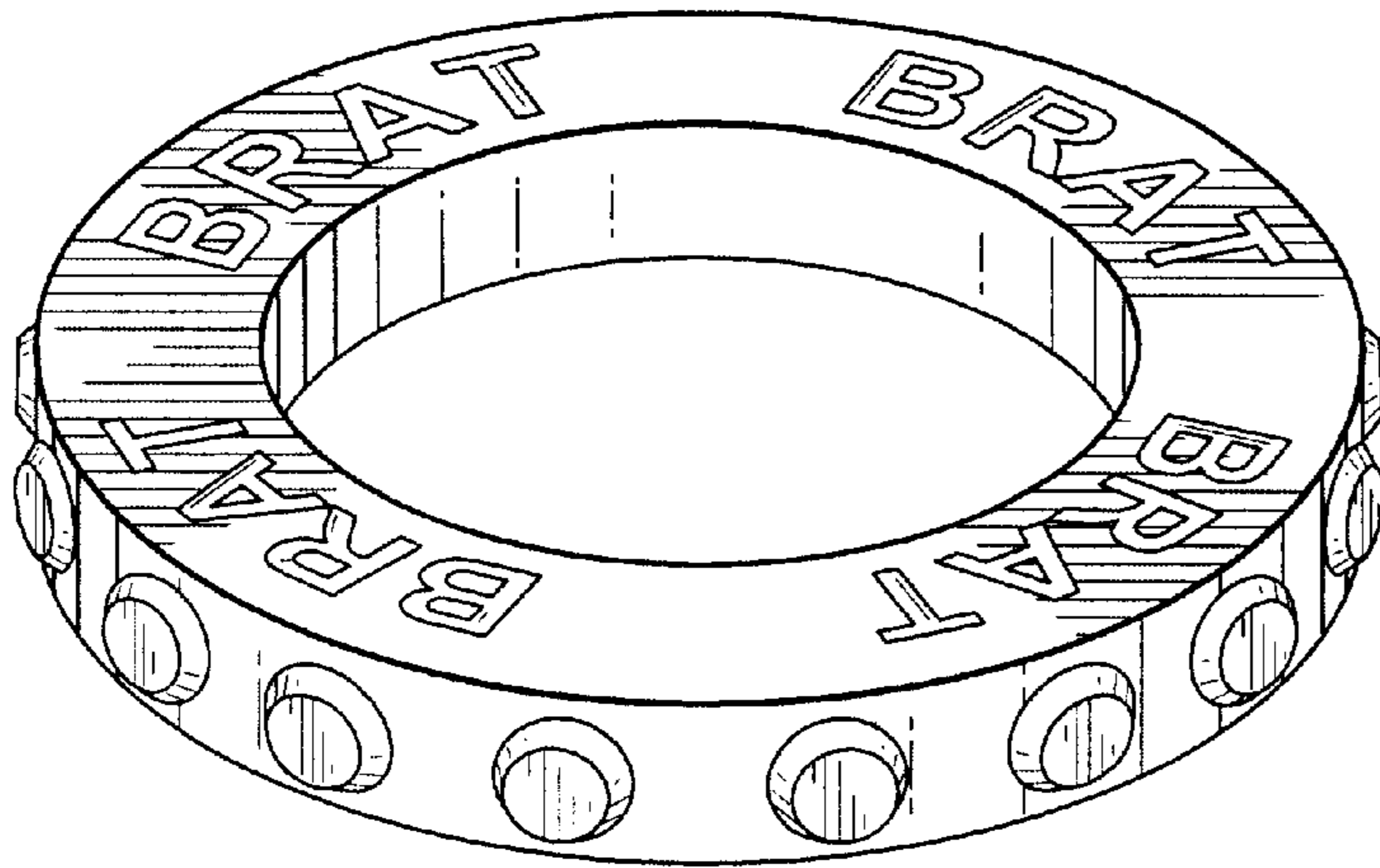

FIG. 130

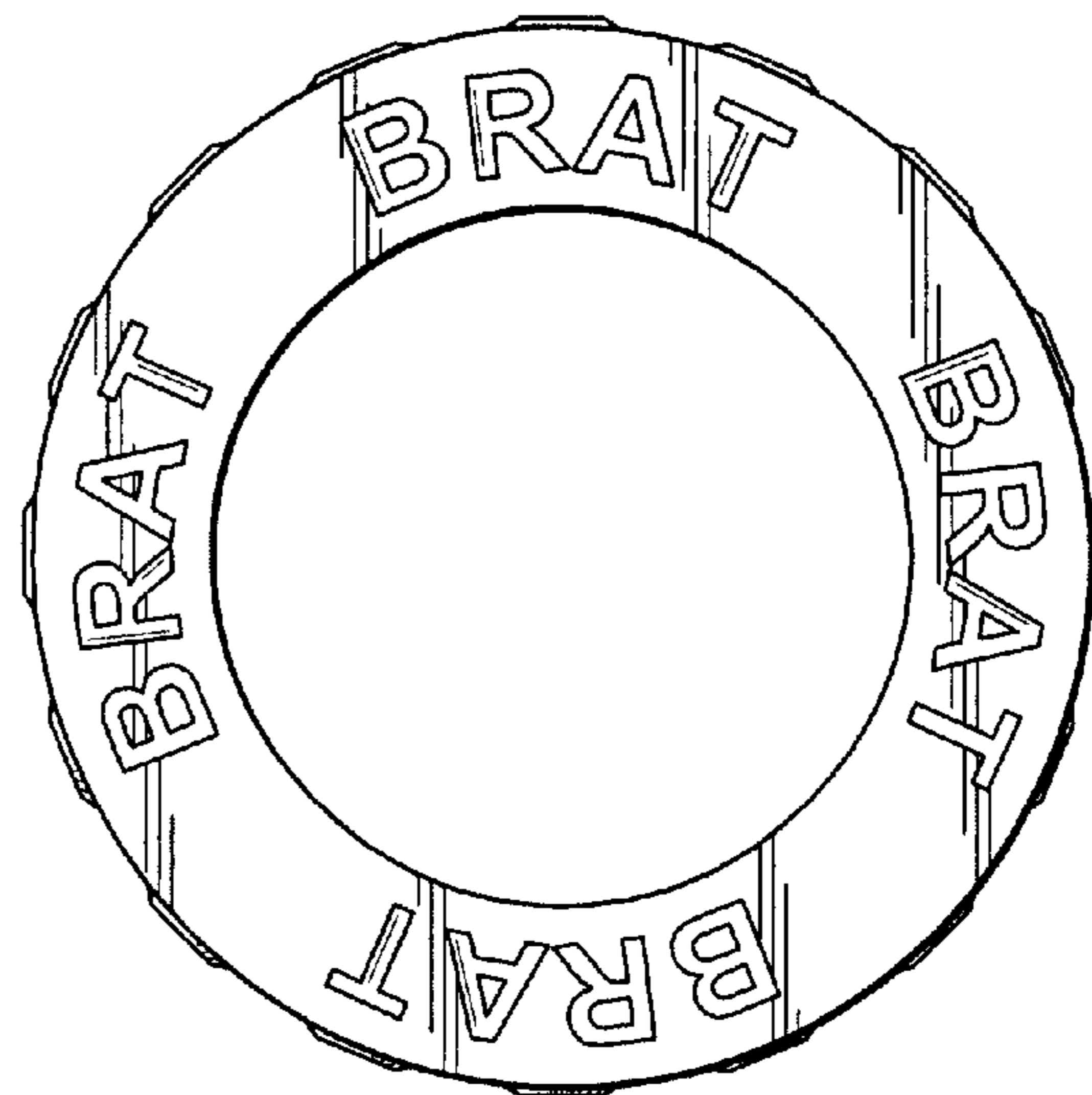

FIG. 131



FIG. 132

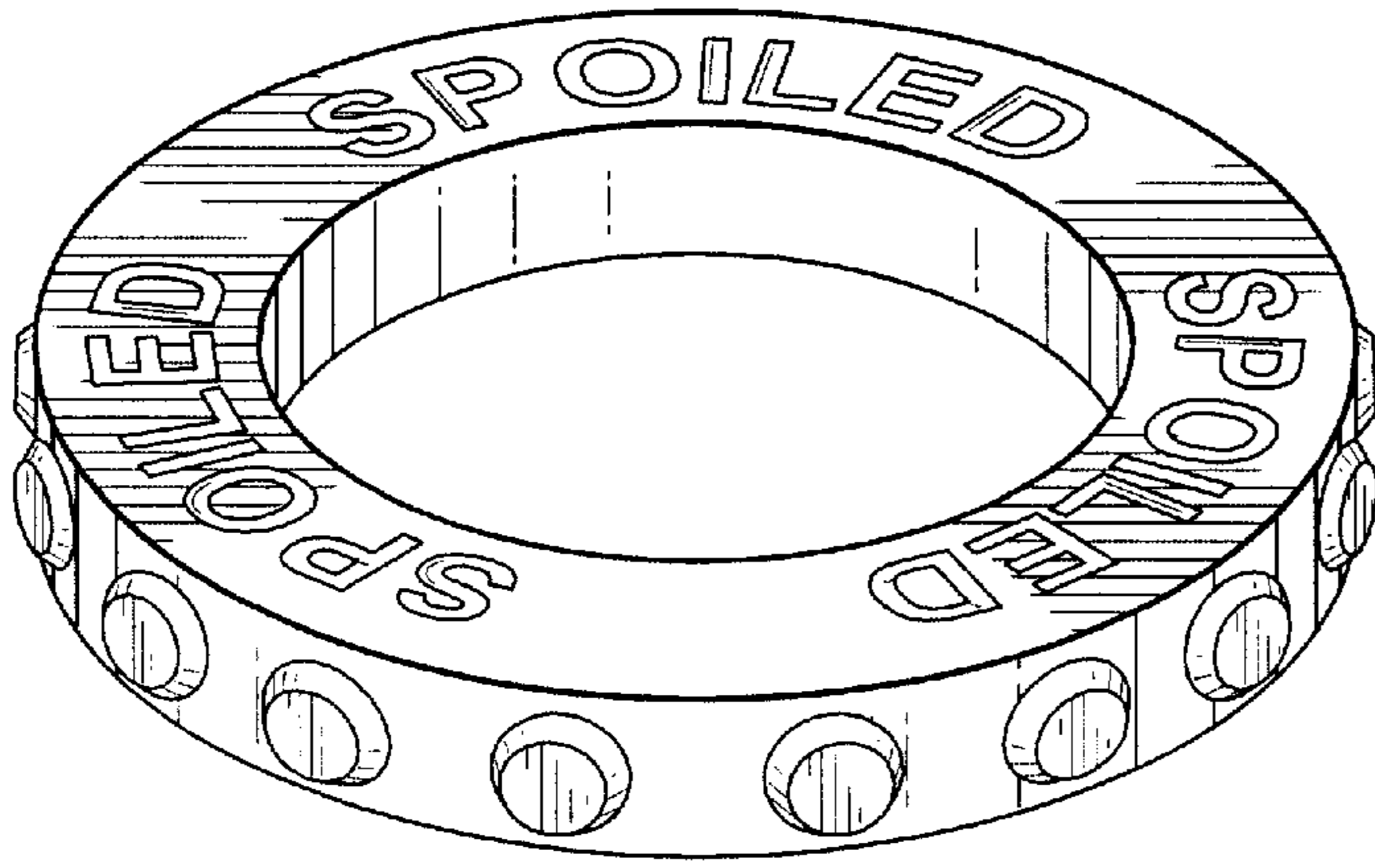

FIG. 133

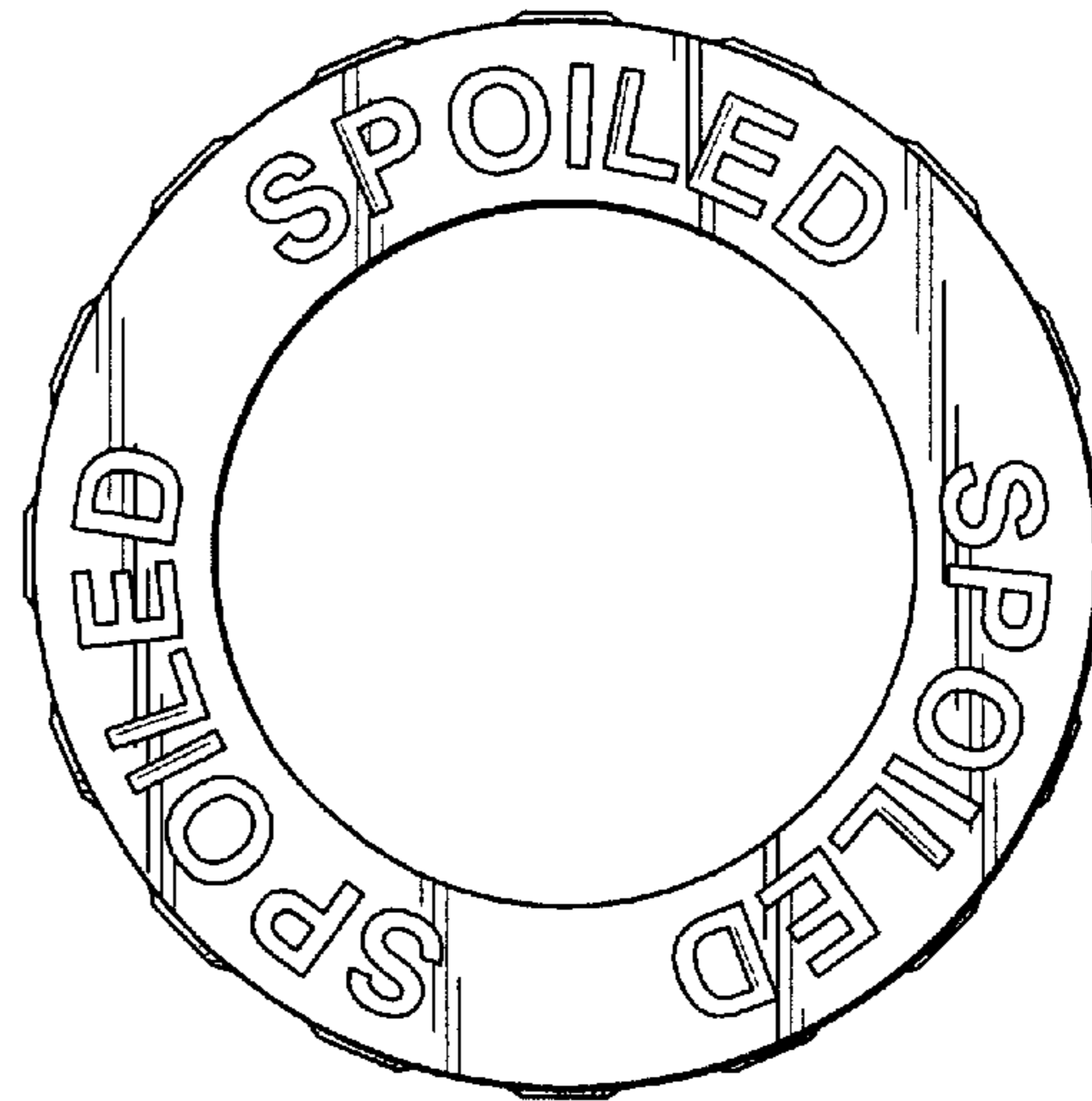

FIG. 134

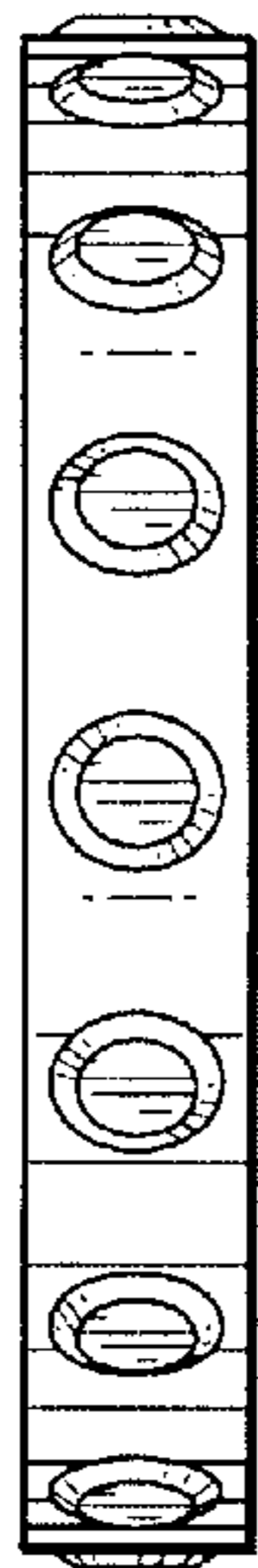

FIG. 135

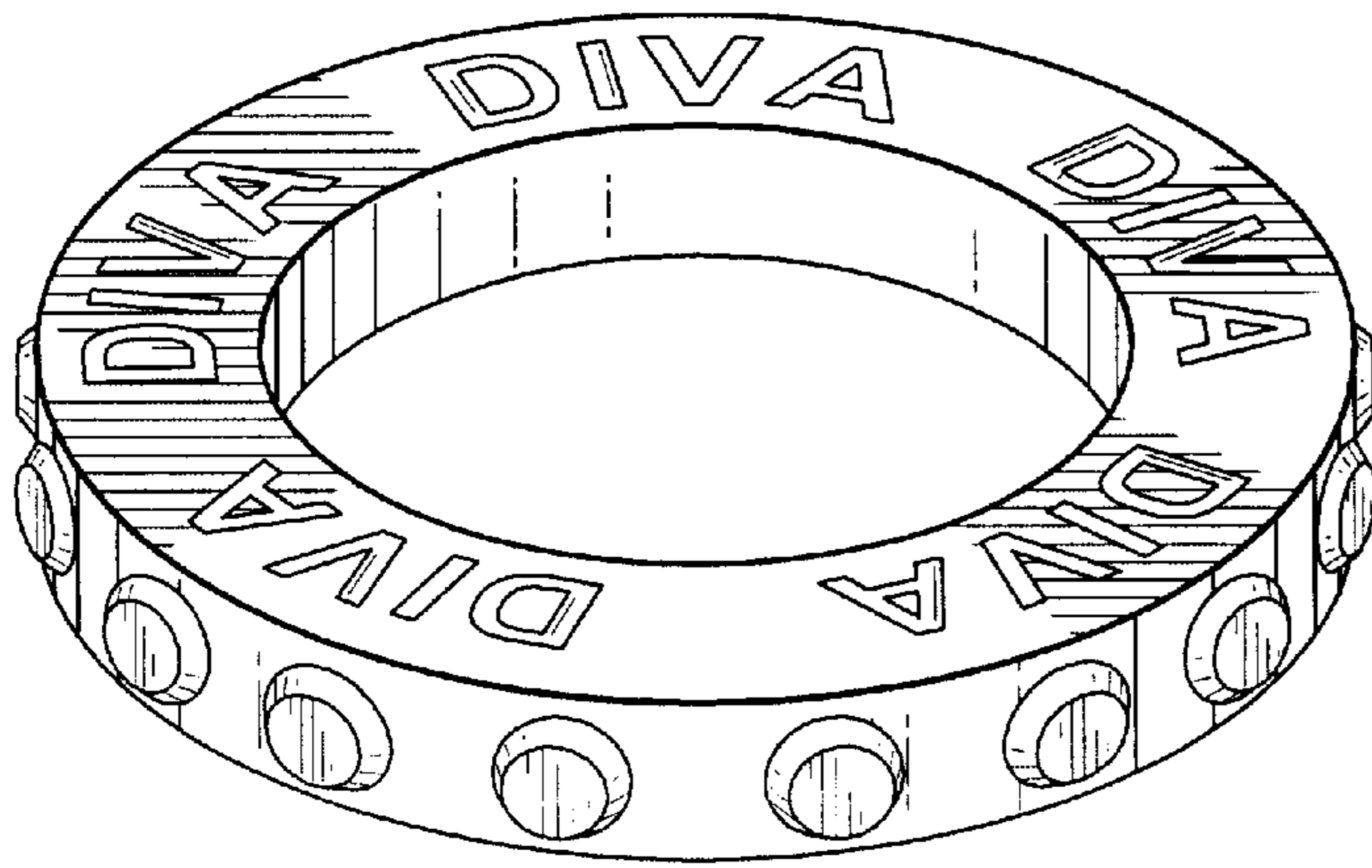

FIG. 136



FIG. 137

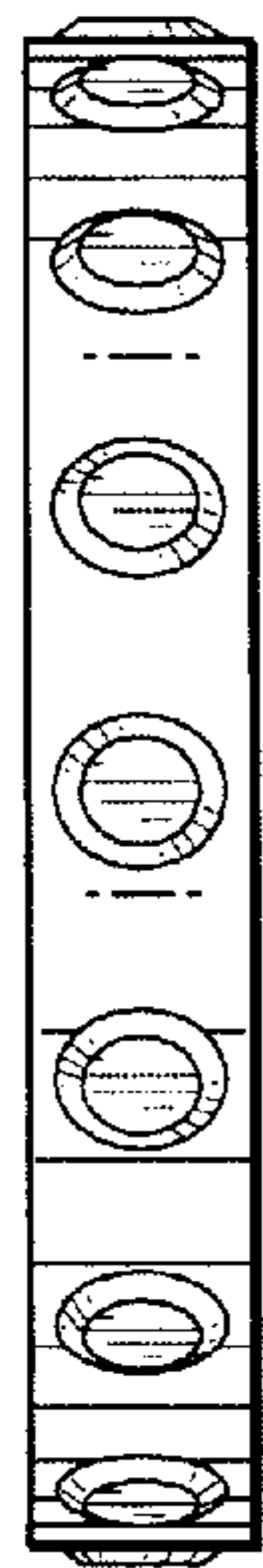

FIG. 138

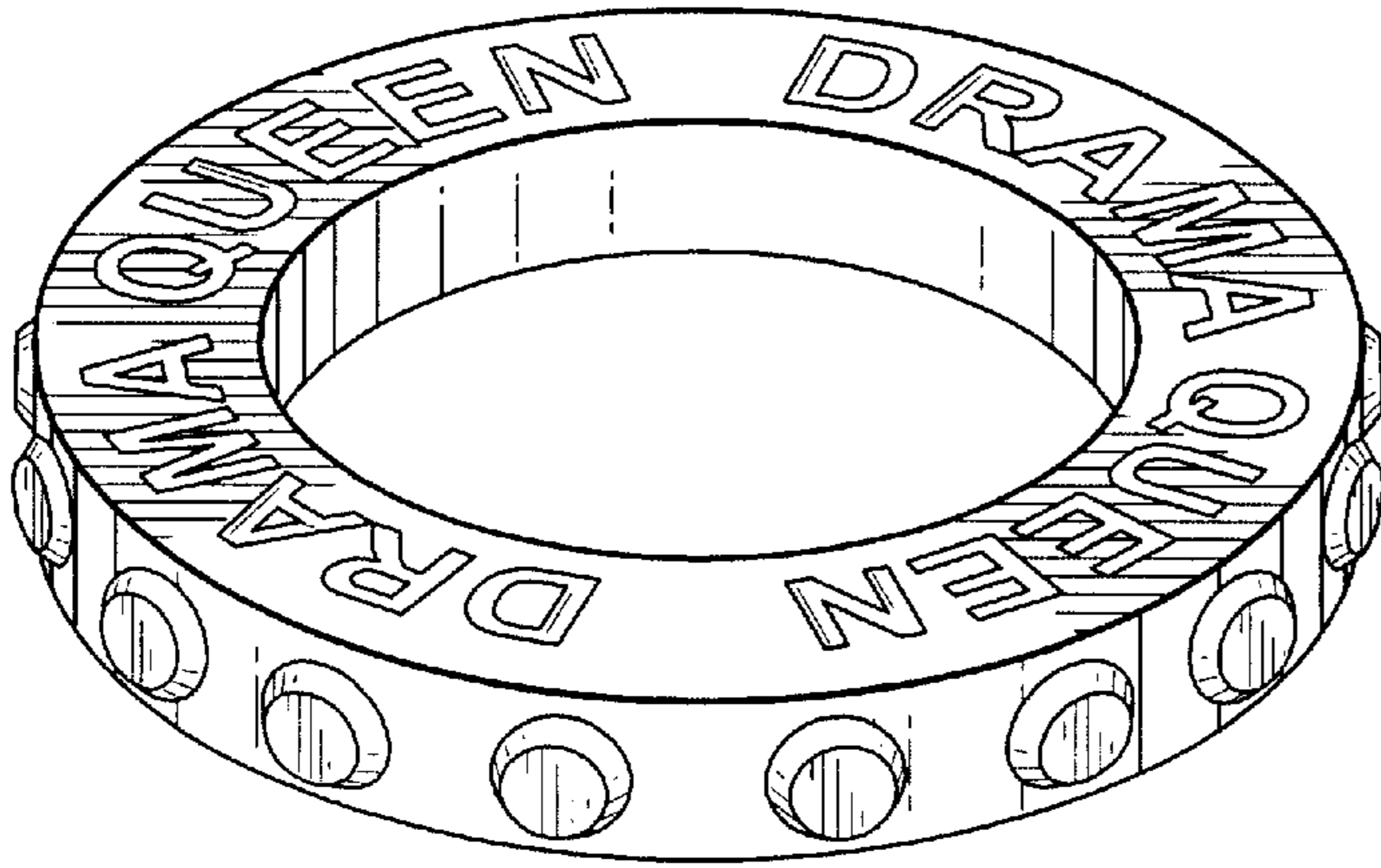

FIG. 139



FIG. 140

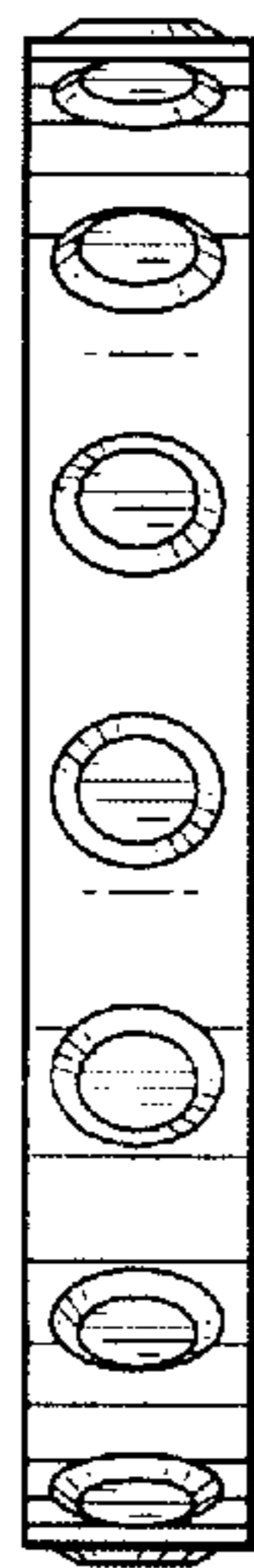

FIG. 141

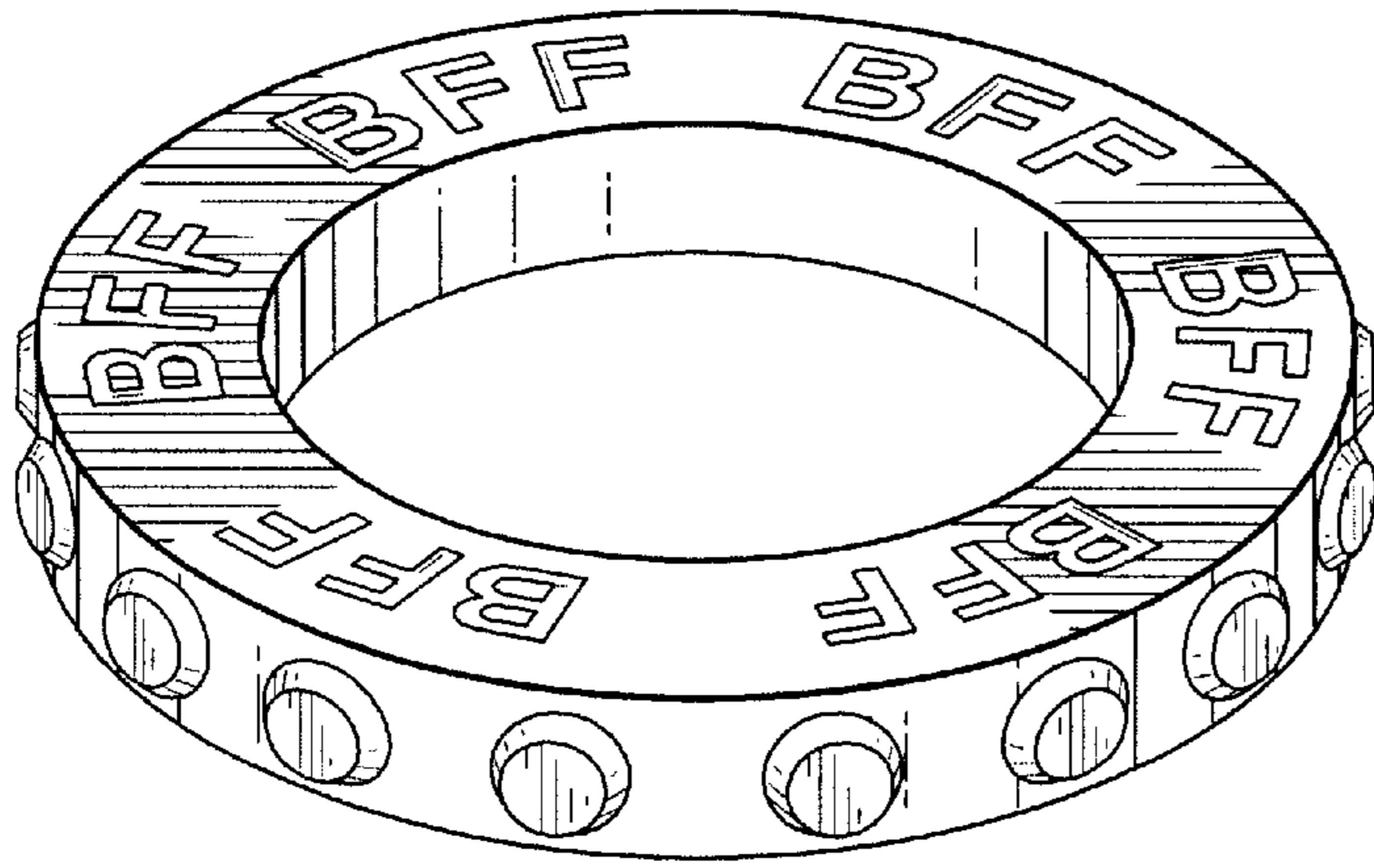

FIG. 142

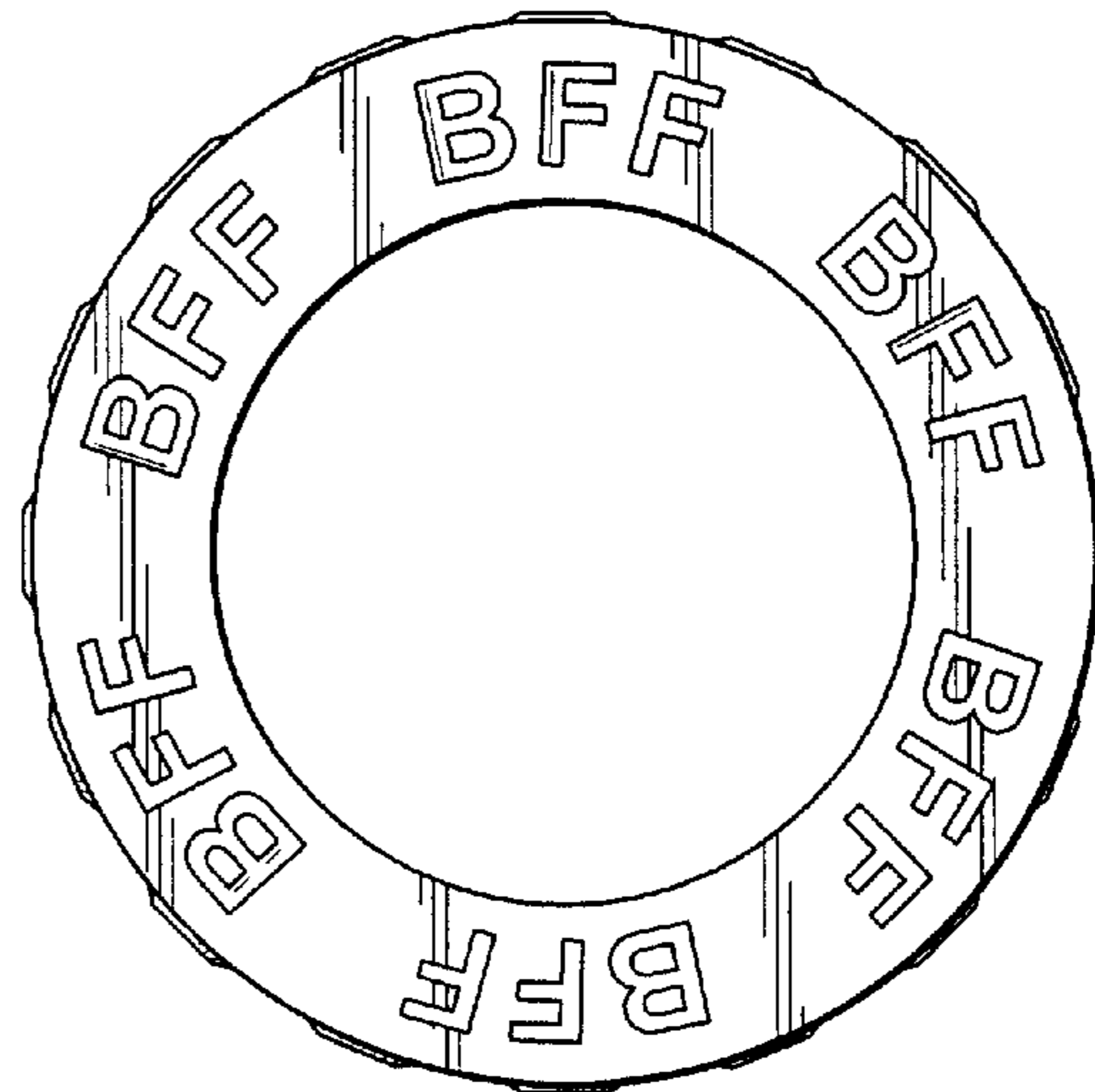

FIG. 143

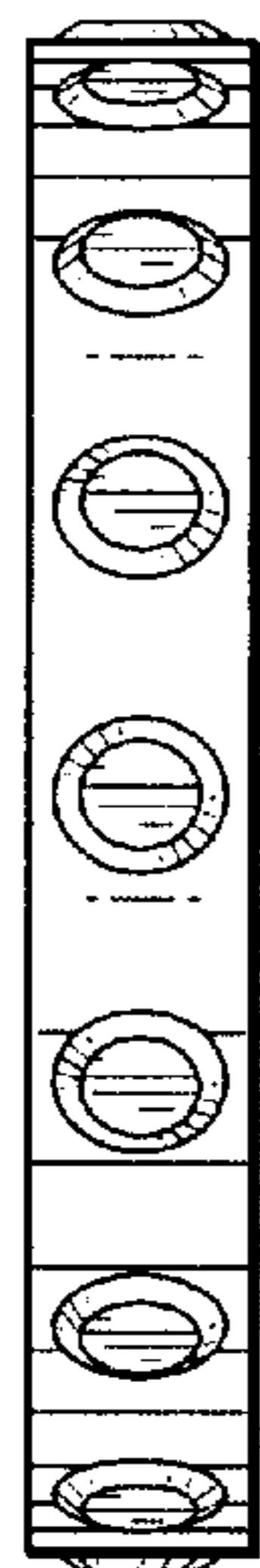

FIG. 144

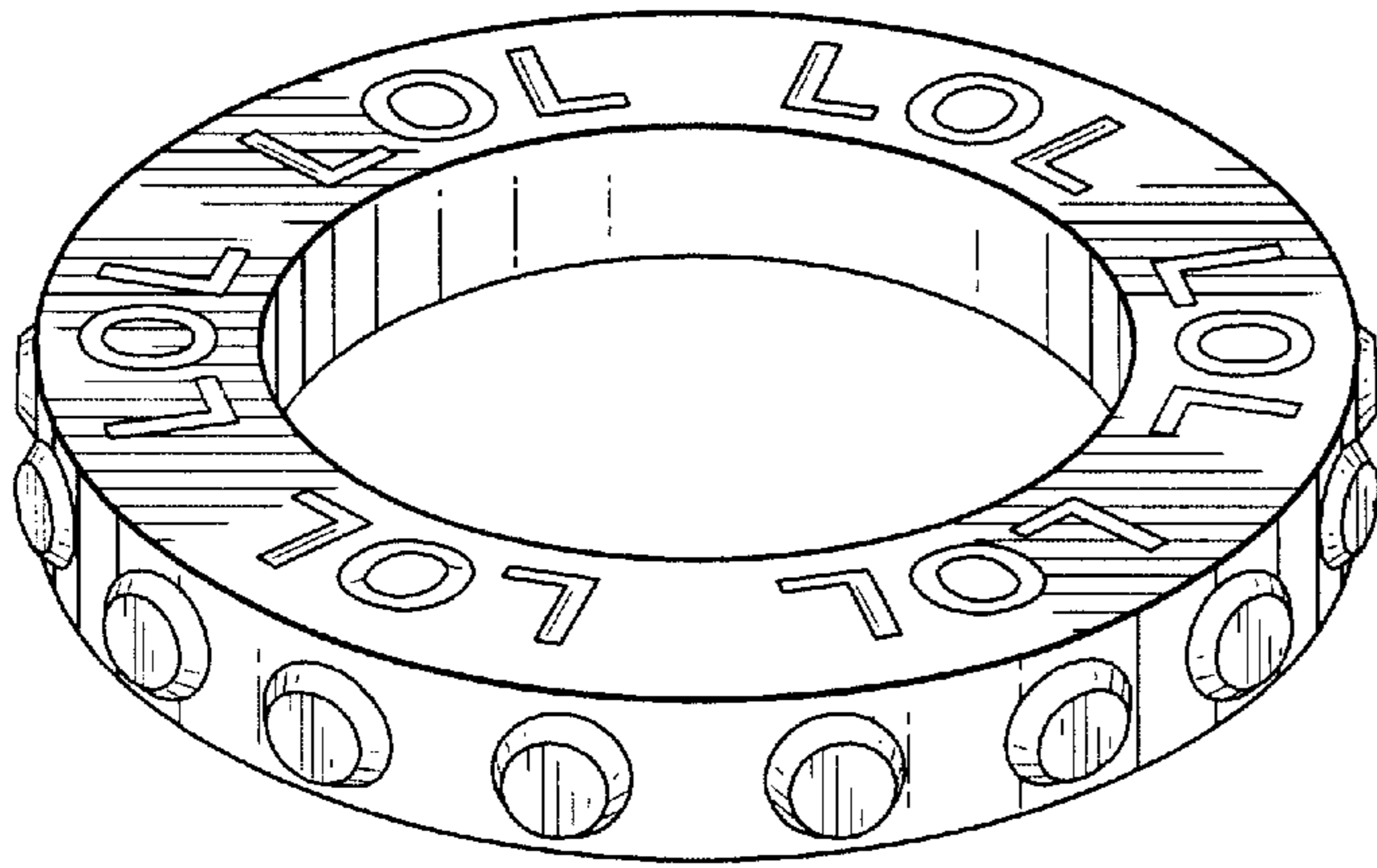

FIG. 145

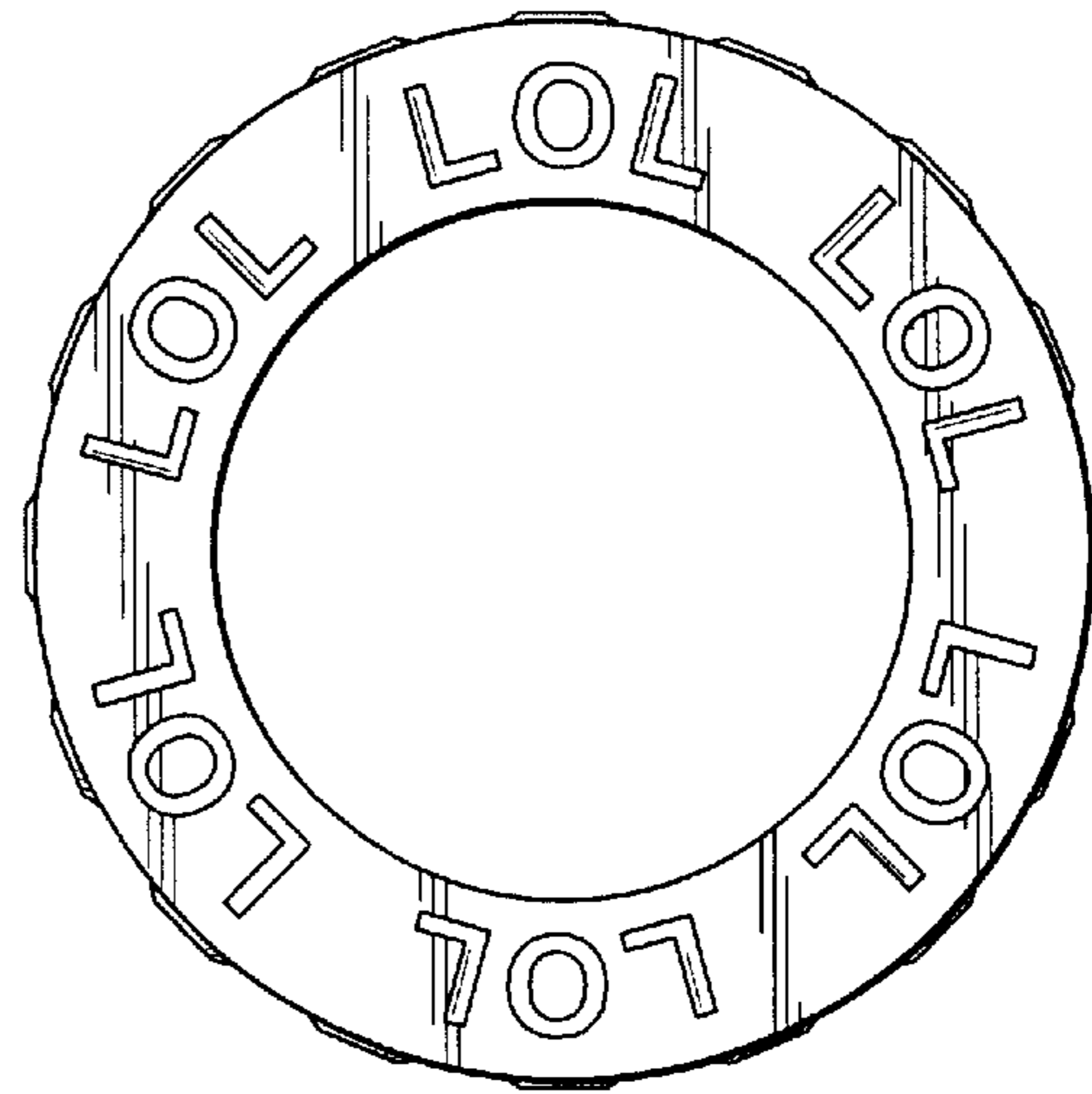

FIG. 146

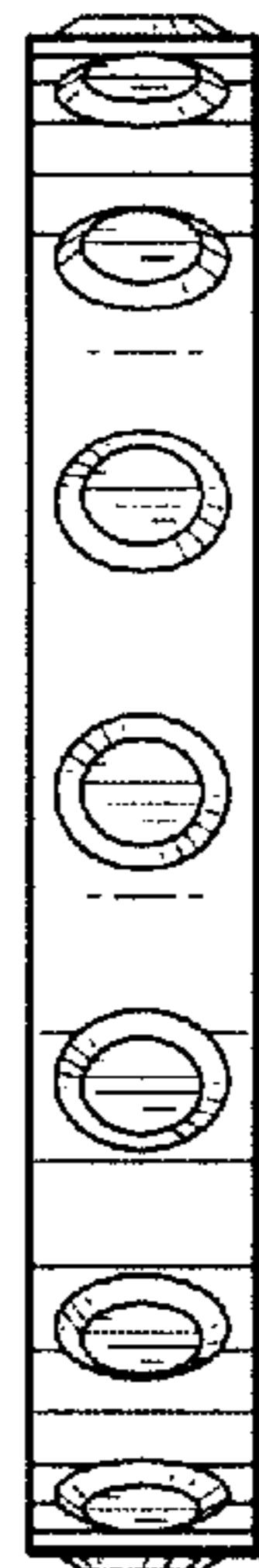

FIG. 147

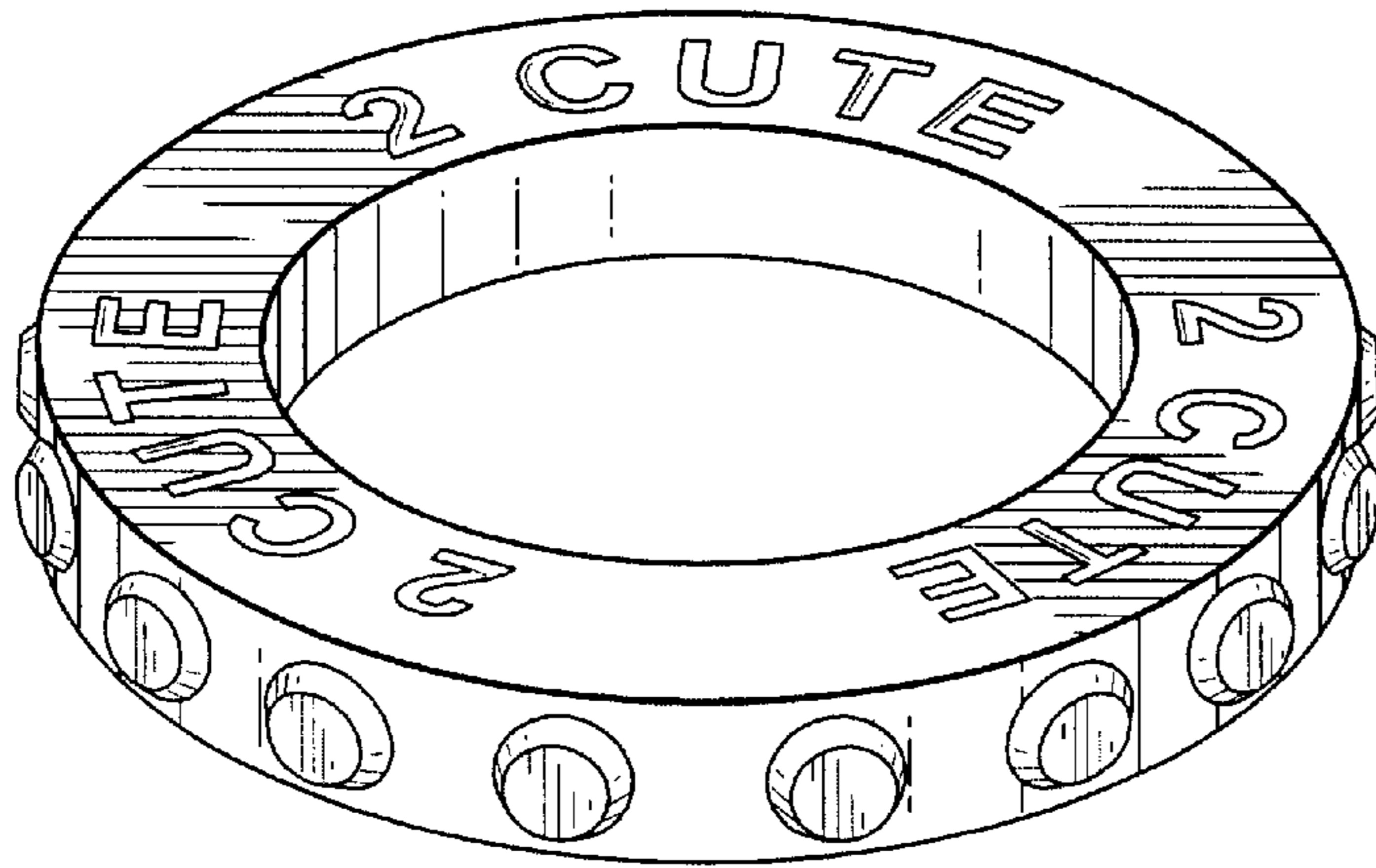

FIG. 148

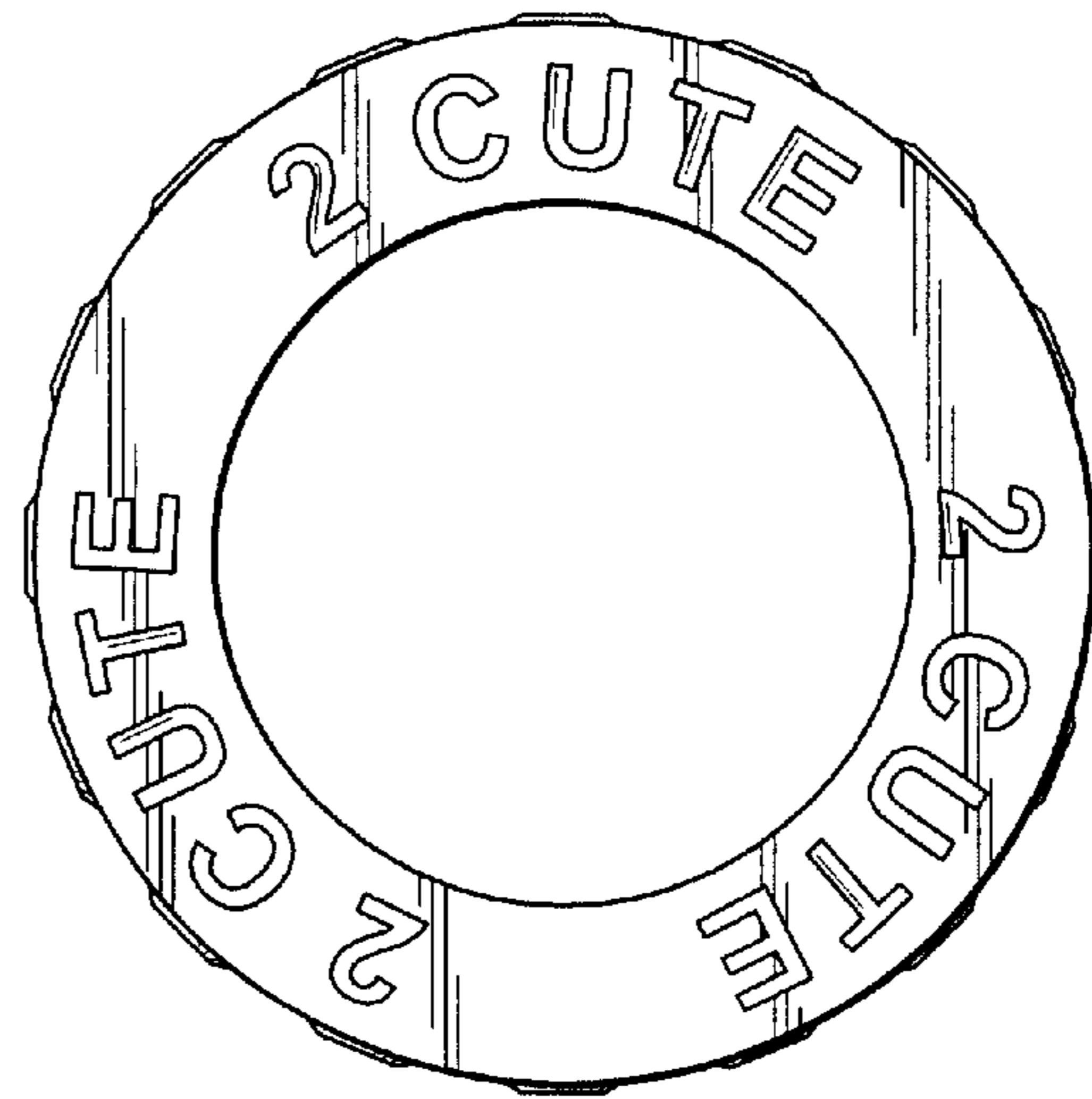

FIG. 149

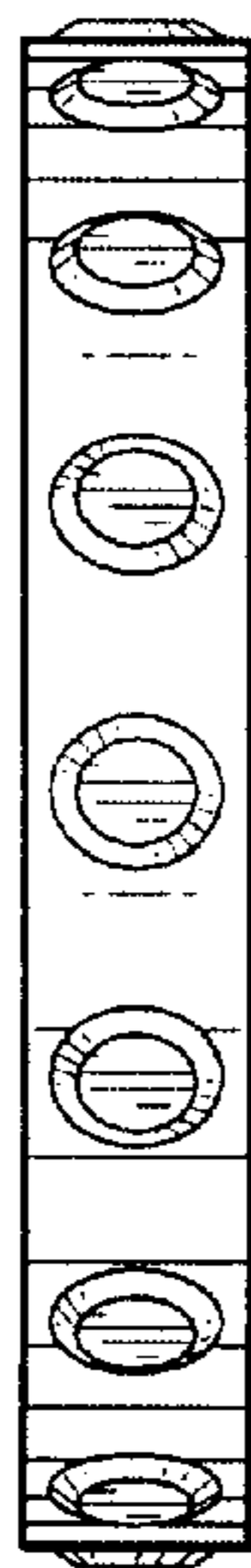

FIG. 150

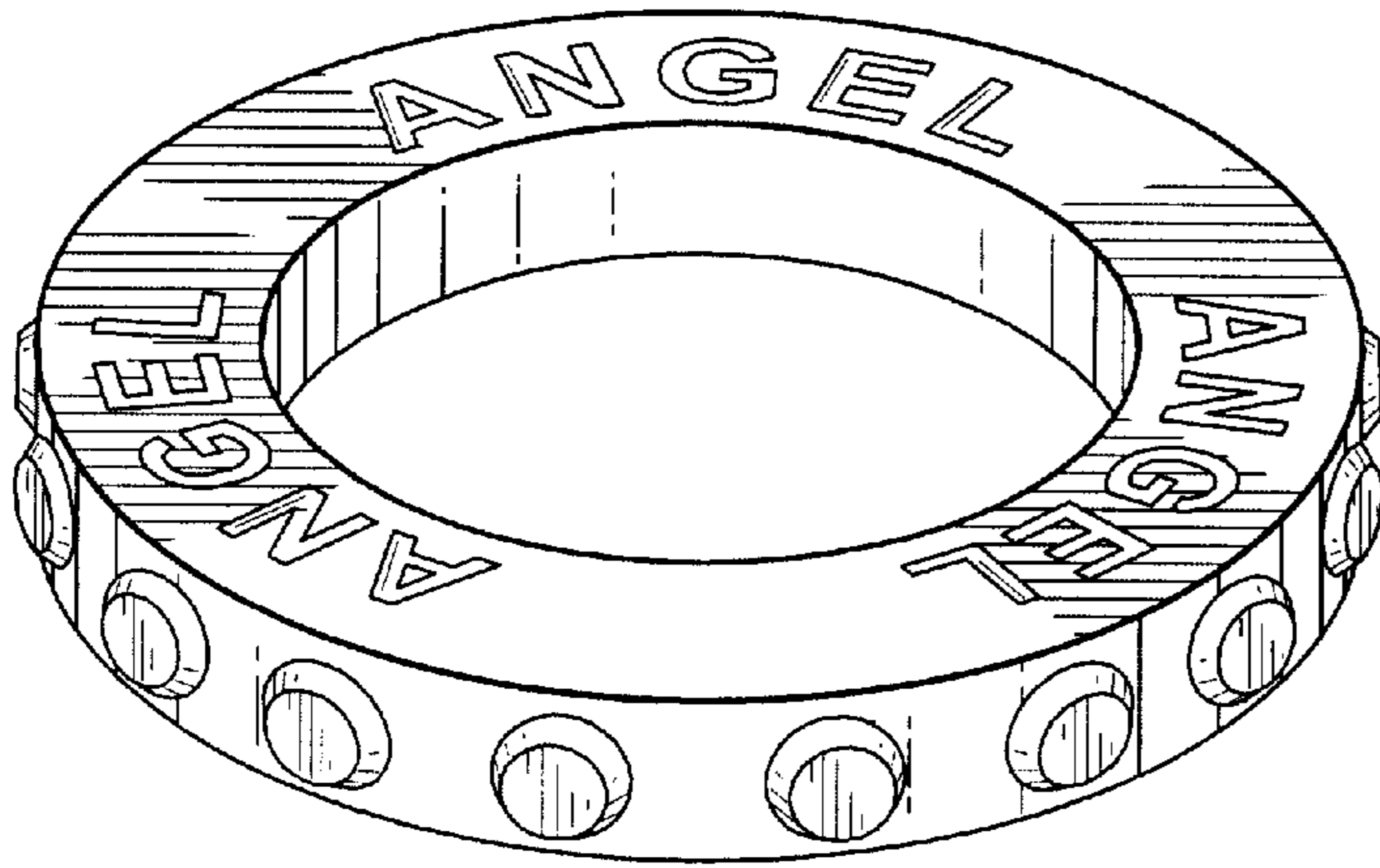

FIG. 151

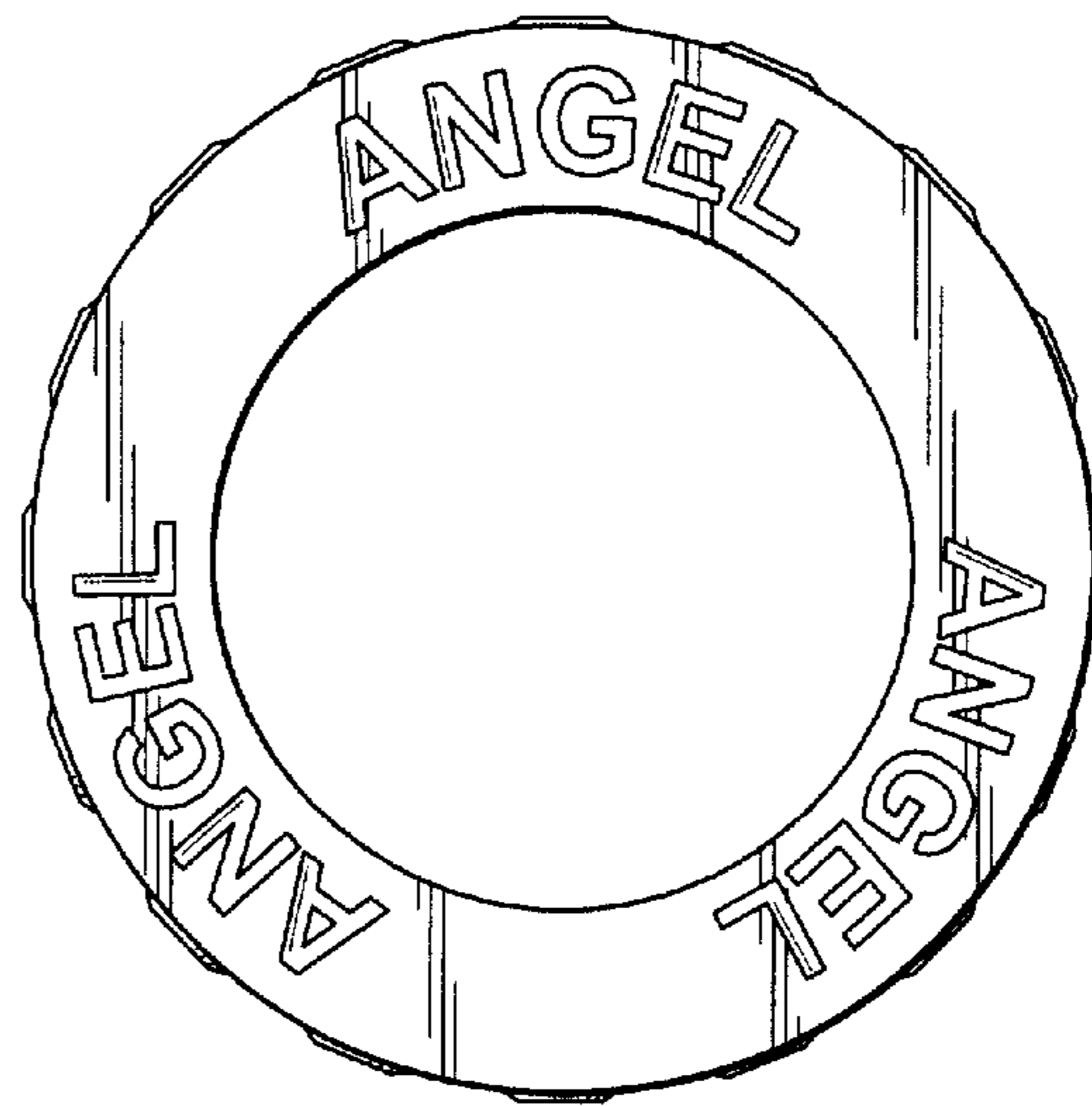

FIG. 152

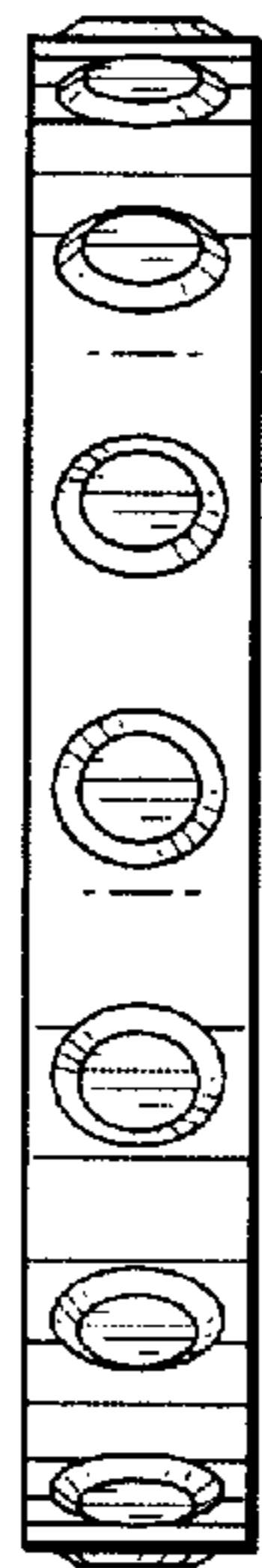

FIG. 153

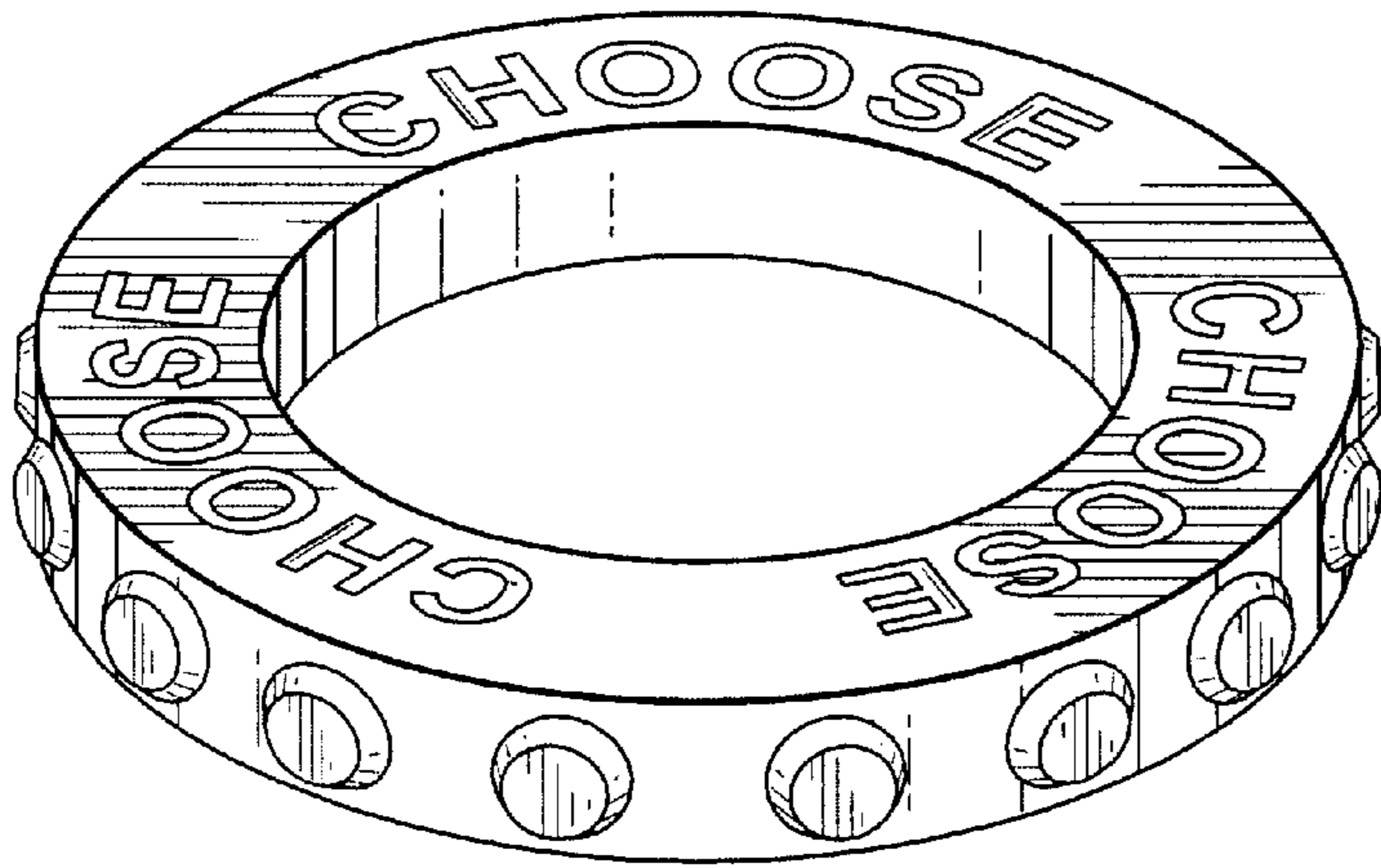

FIG. 154

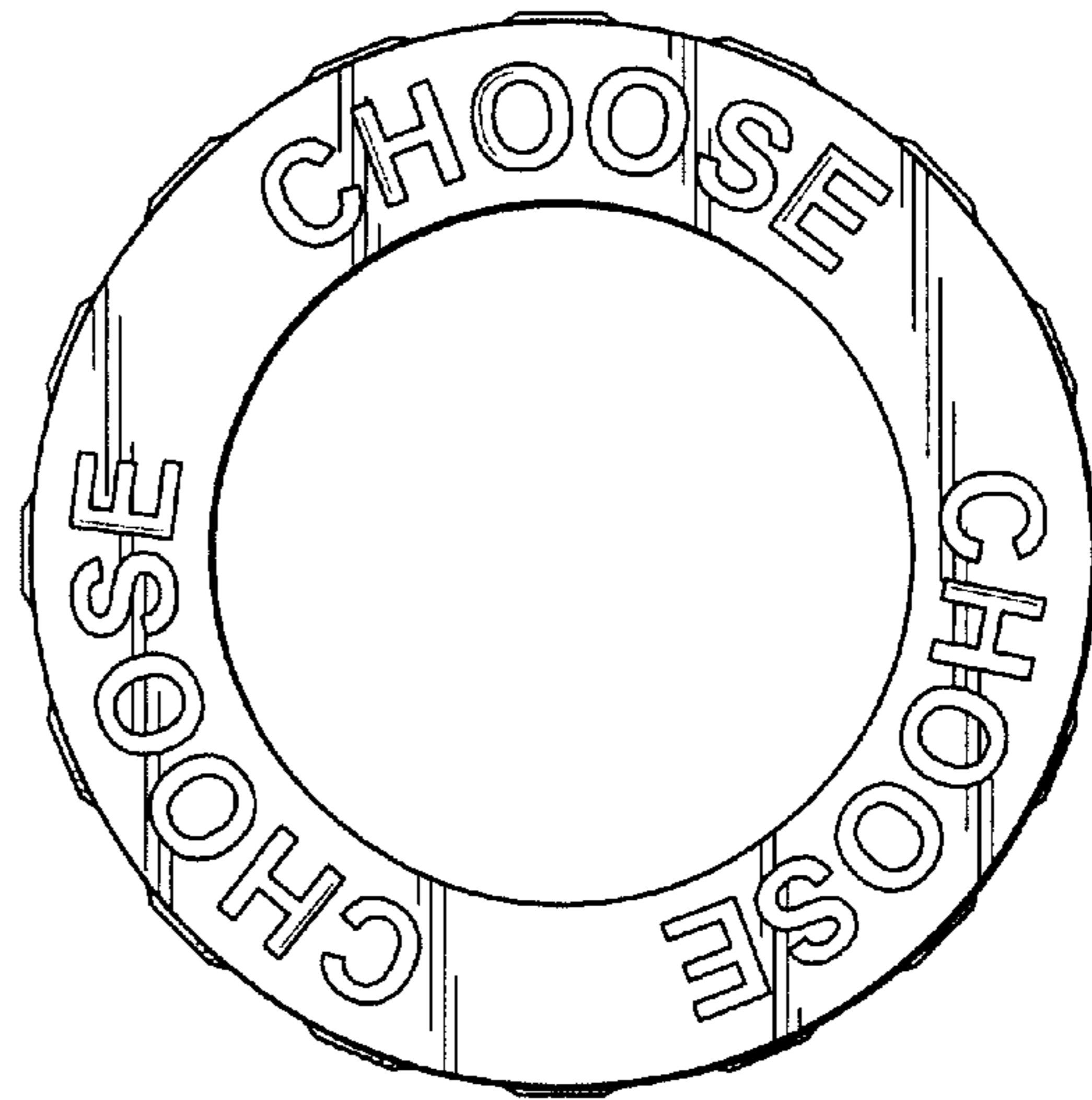

FIG. 155

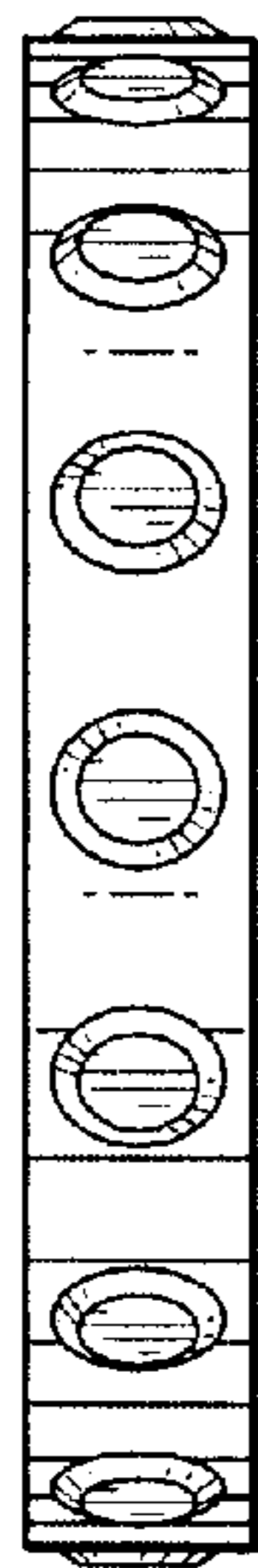

FIG. 156

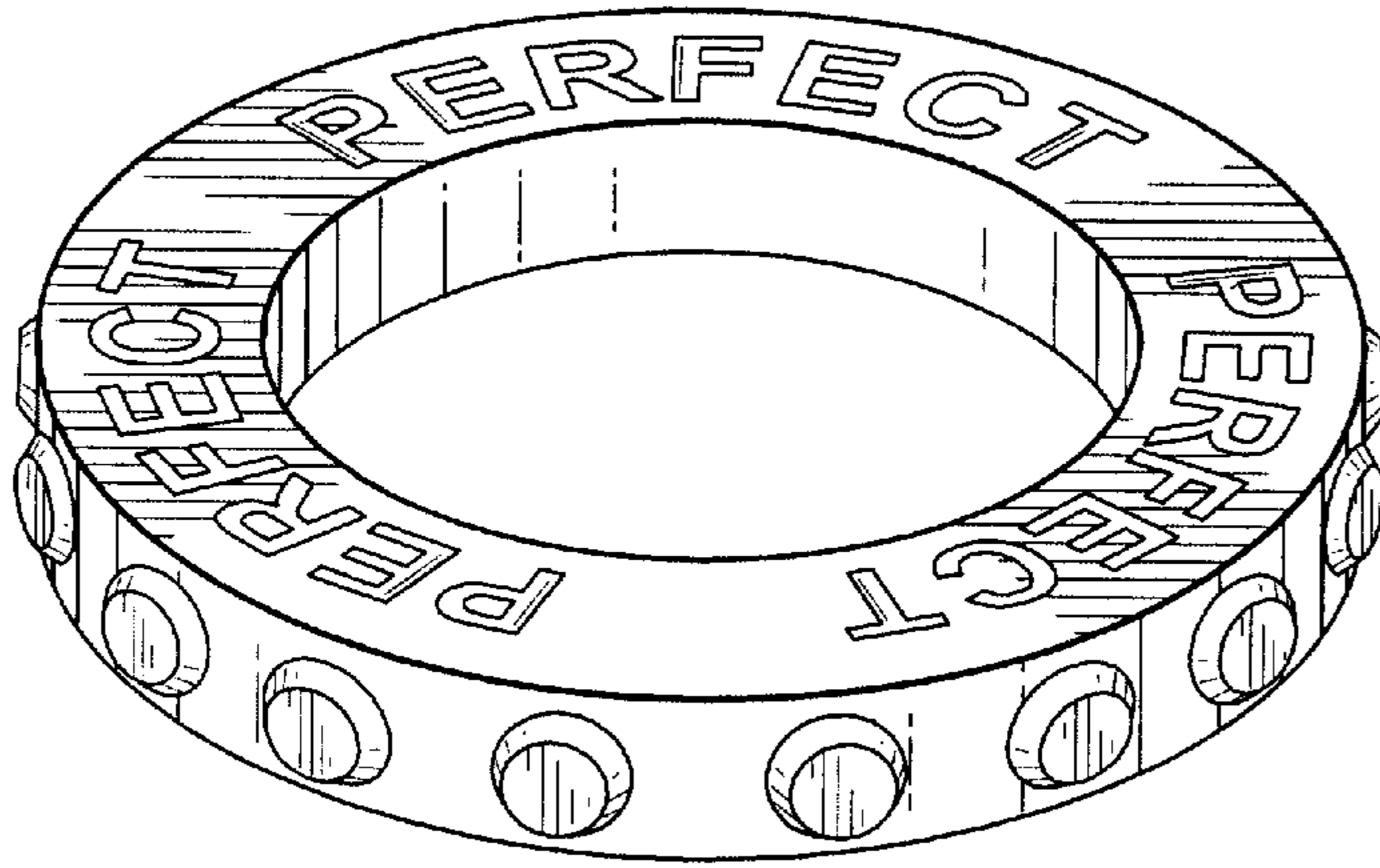

FIG. 157

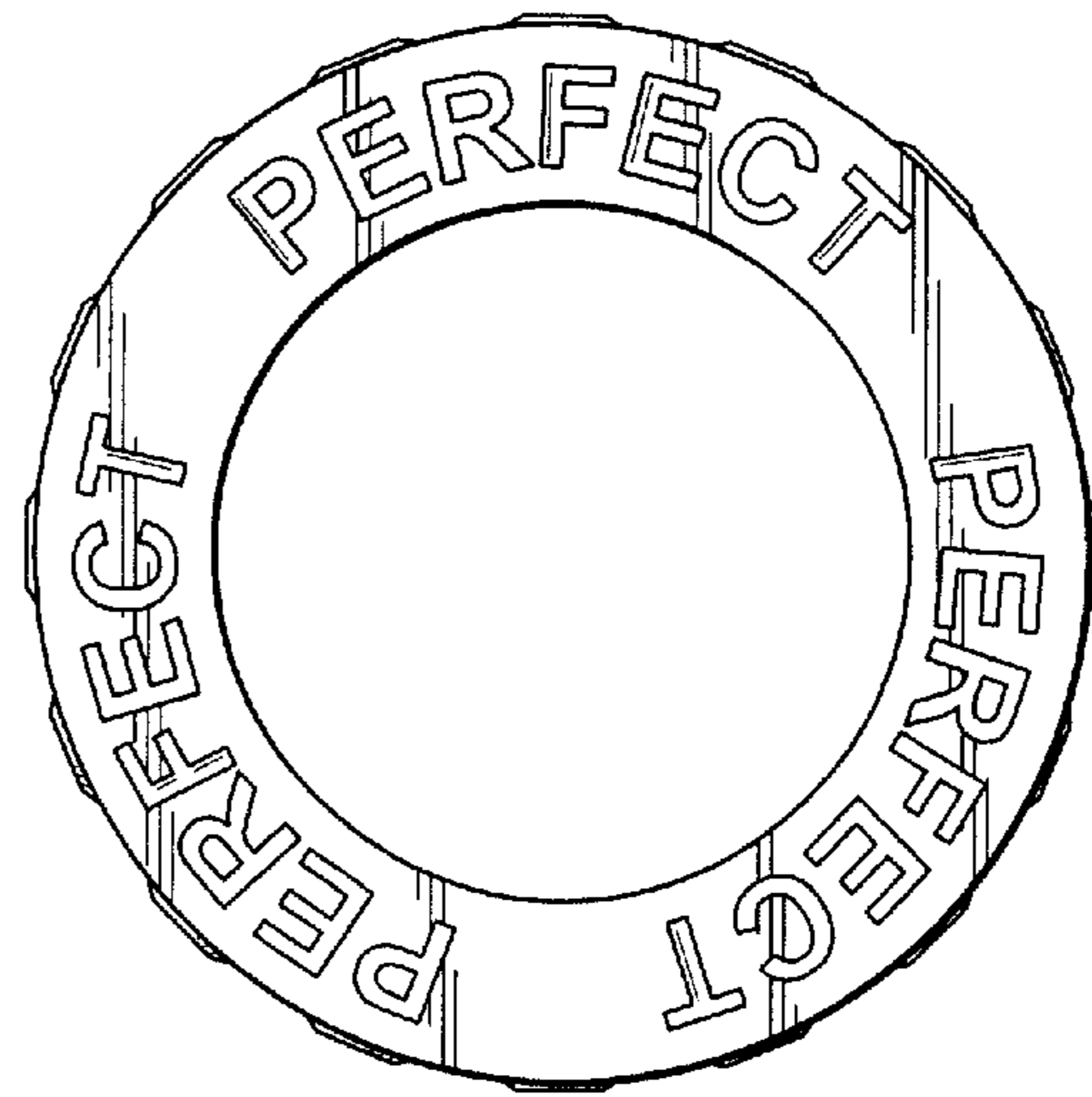

FIG. 158



FIG. 159

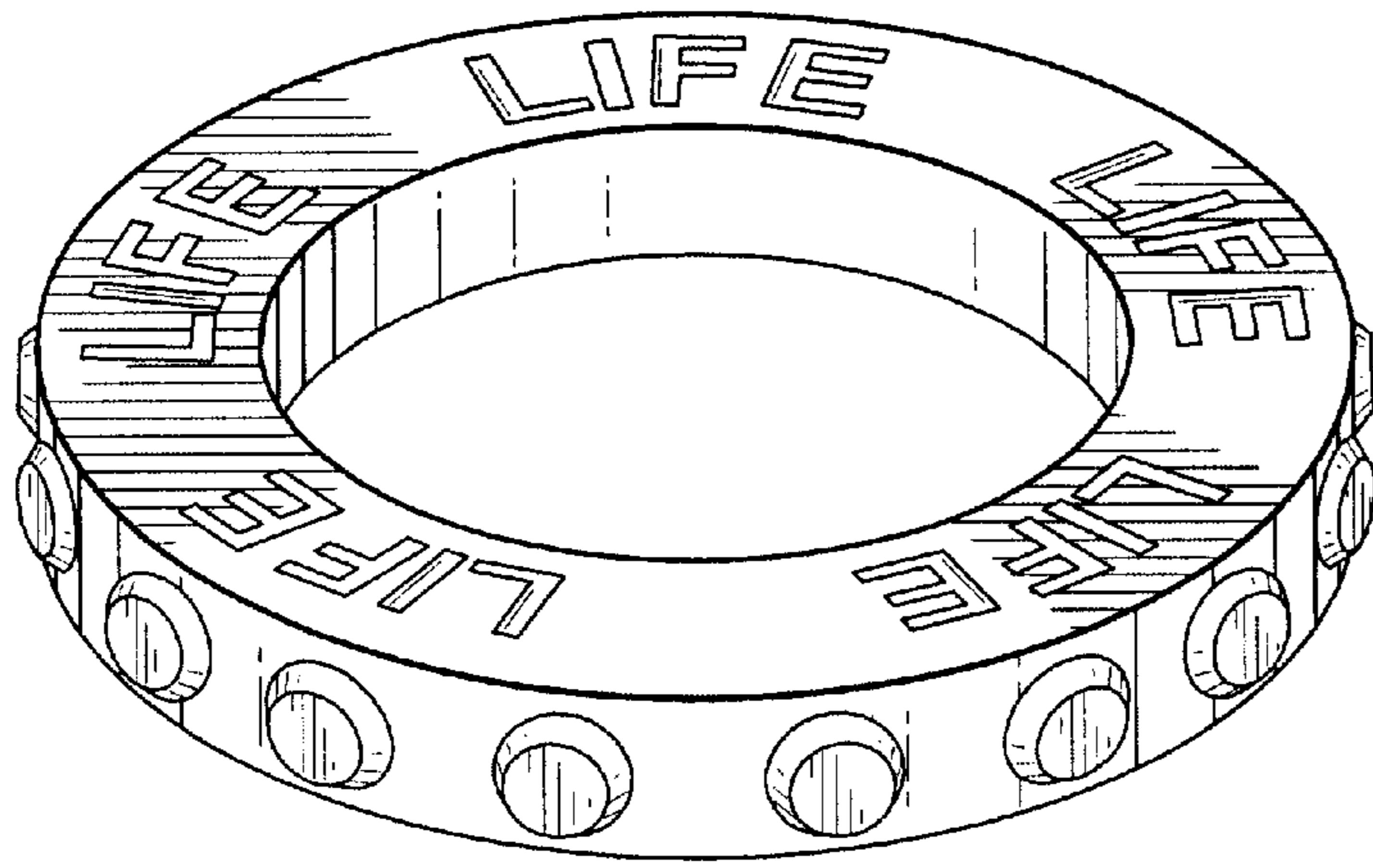

FIG. 160

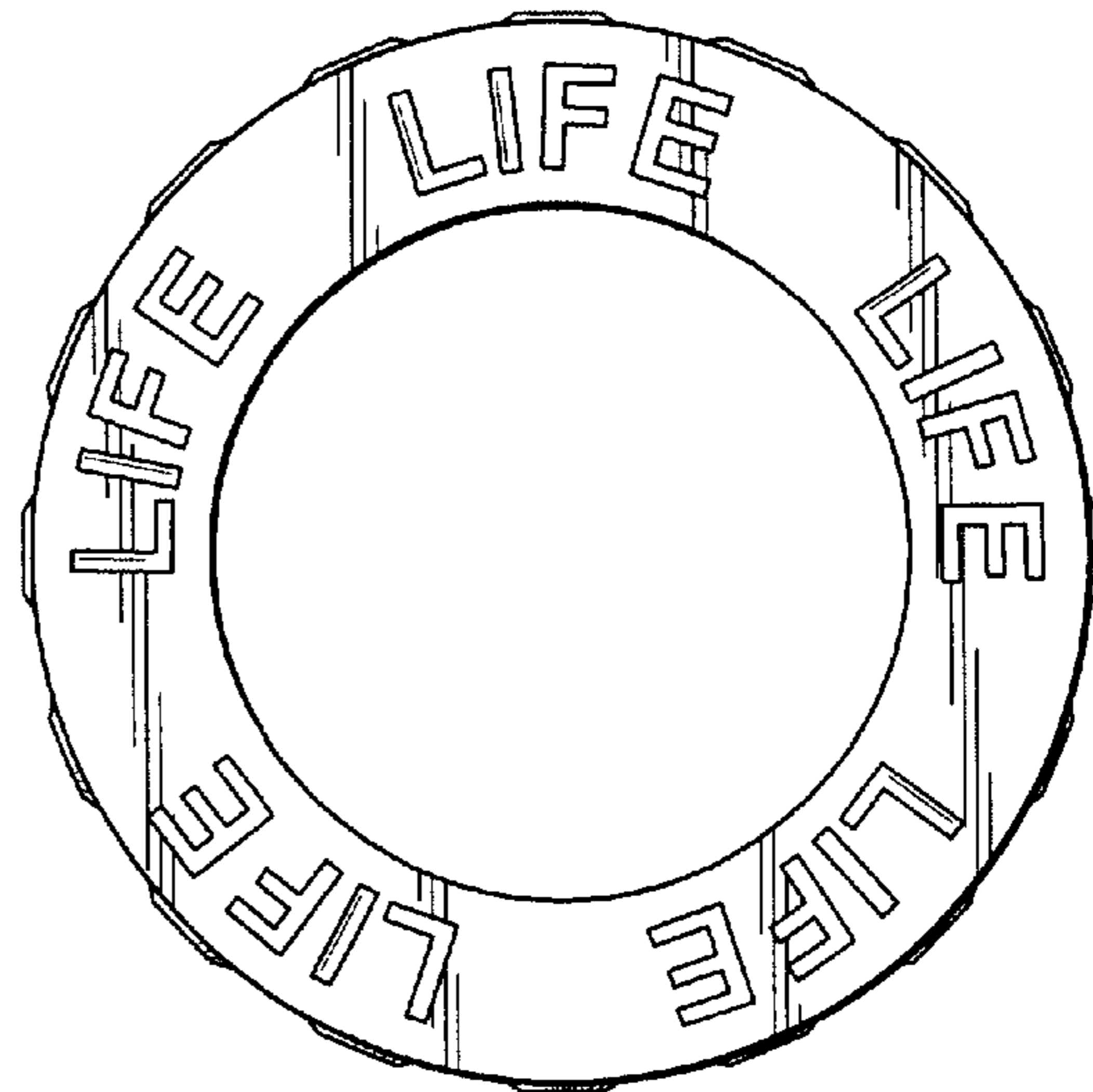

FIG. 161

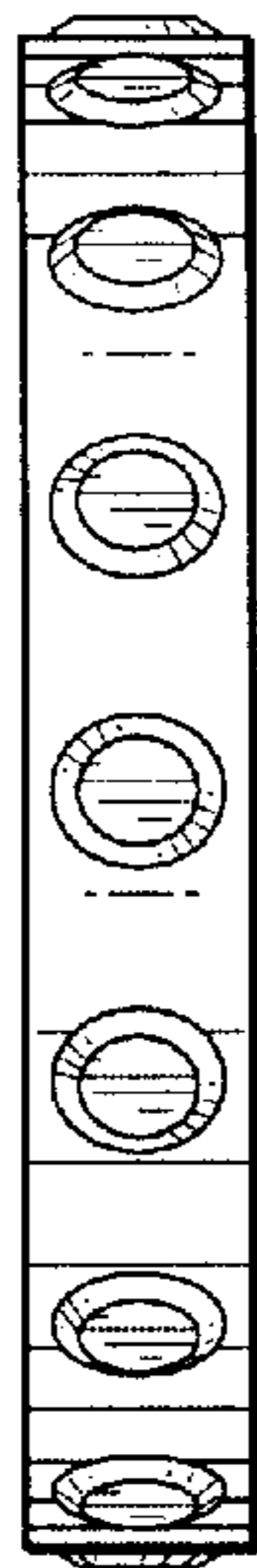

FIG. 162

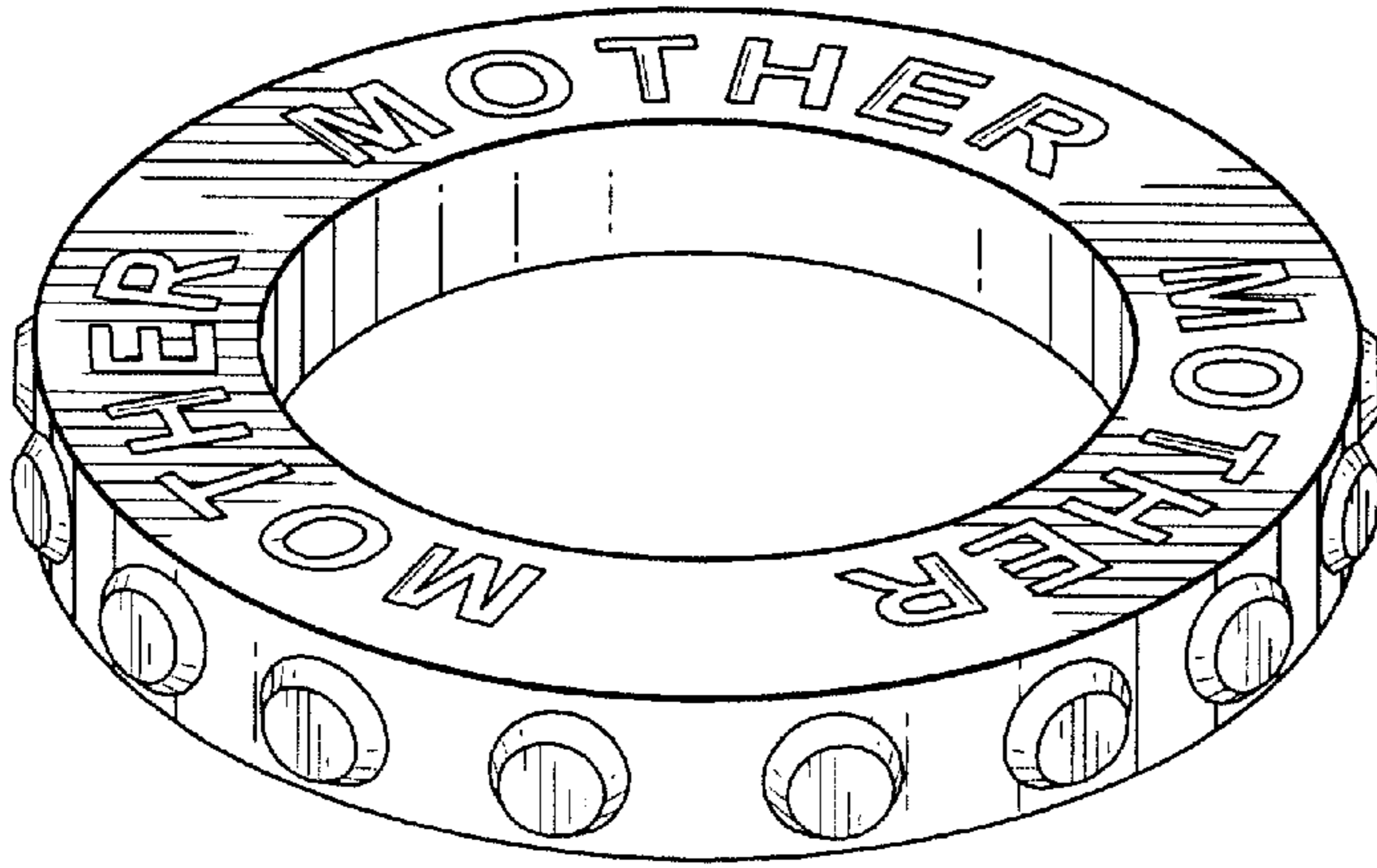

FIG. 163

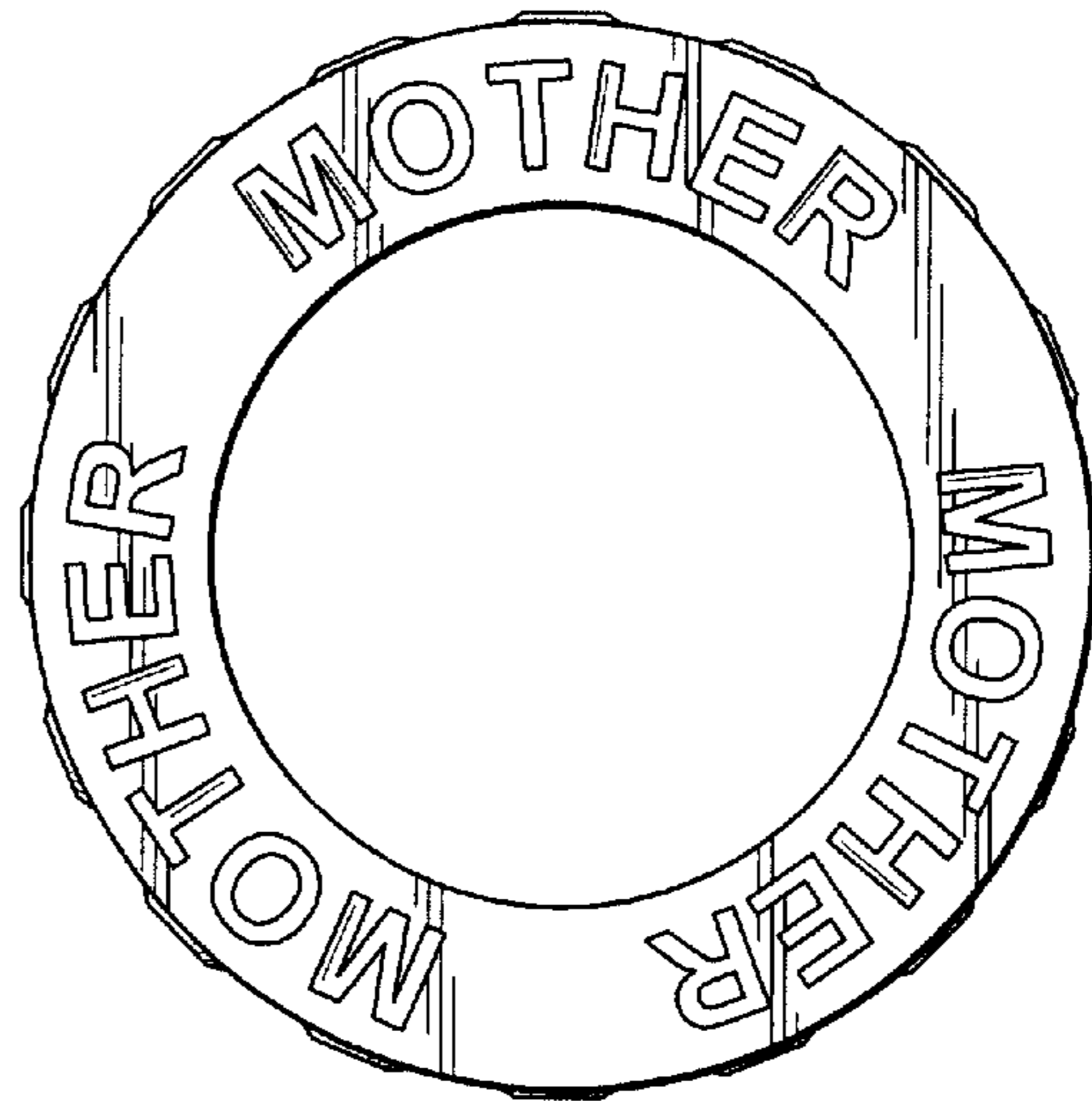

FIG. 164

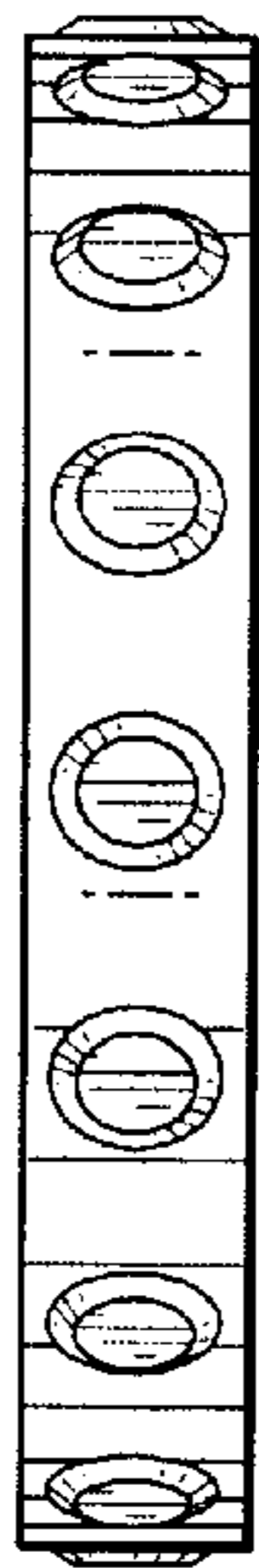

FIG. 165

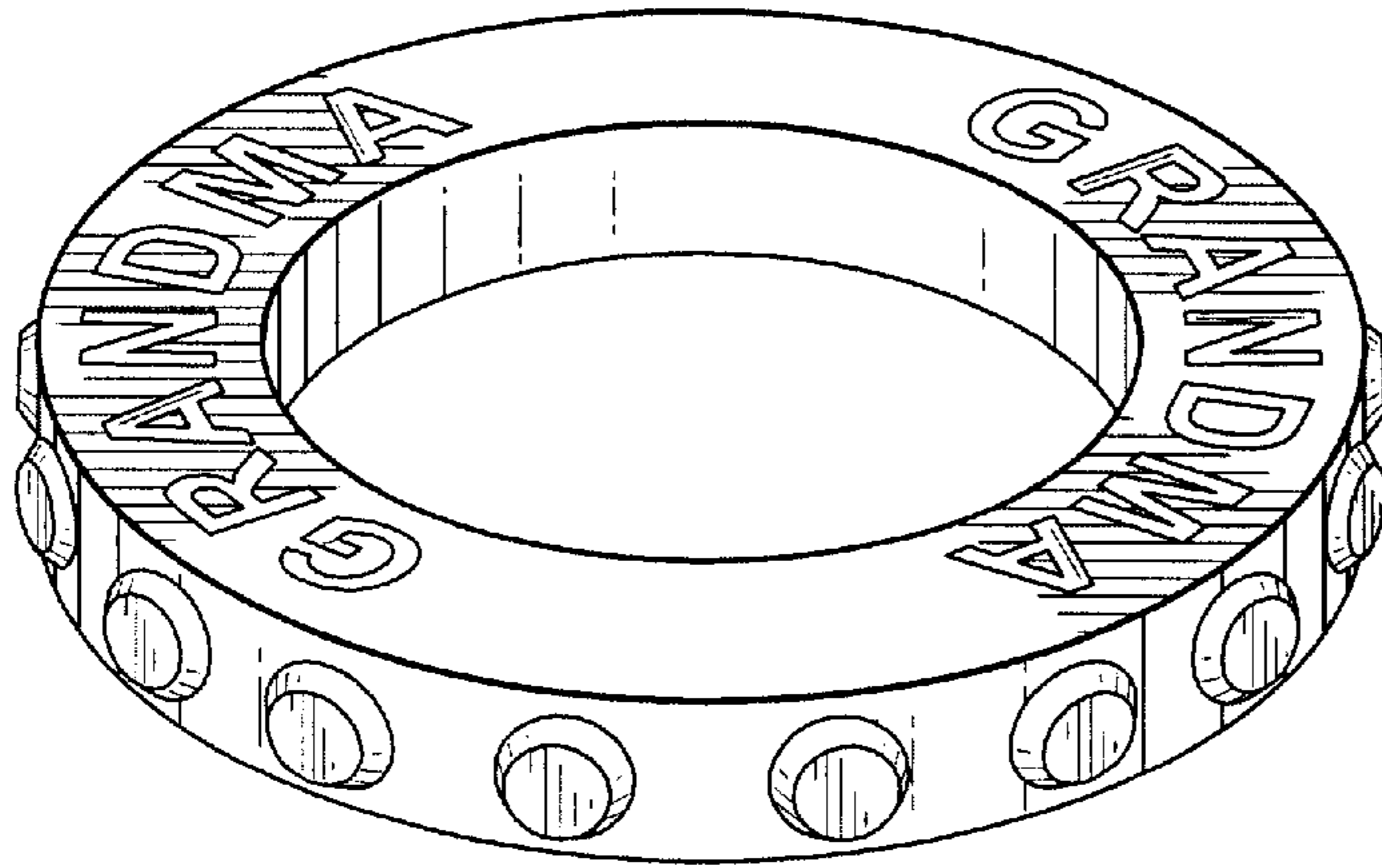

FIG. 166



FIG. 167

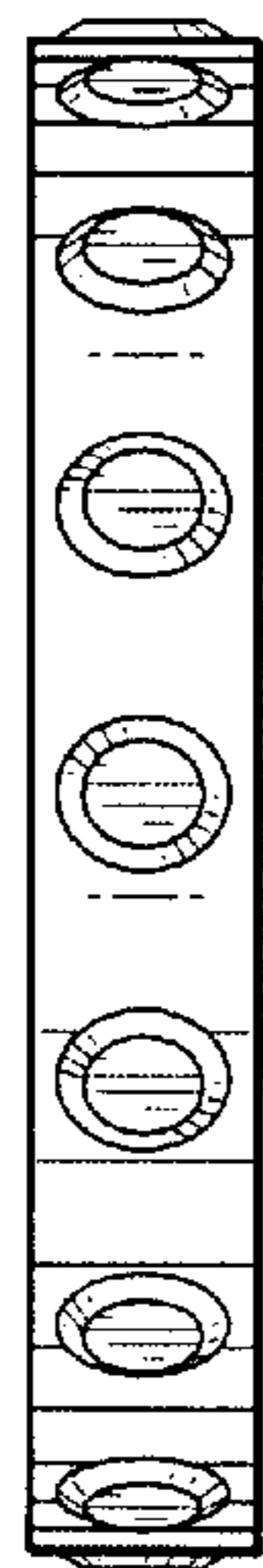

FIG. 168

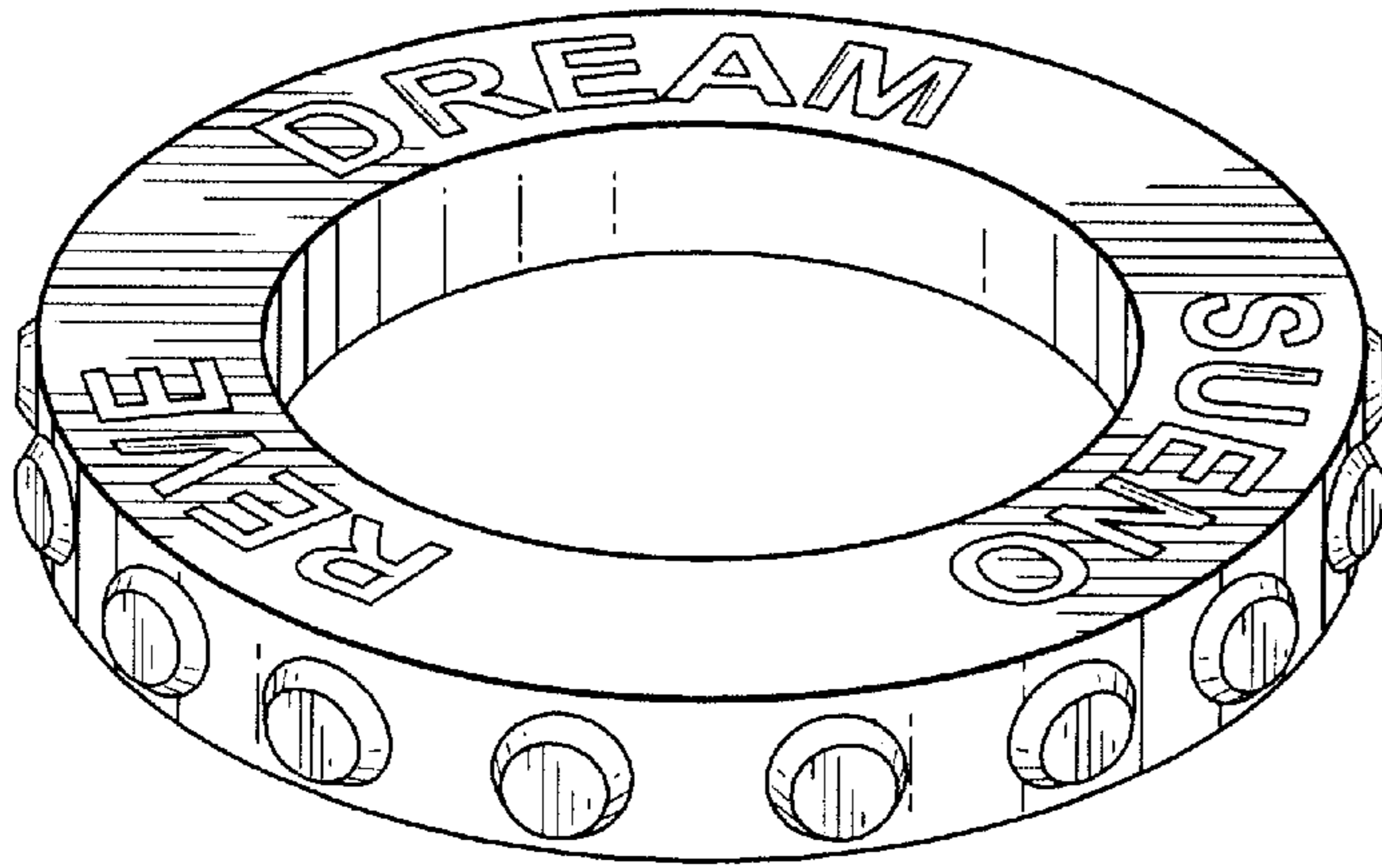

FIG. 169

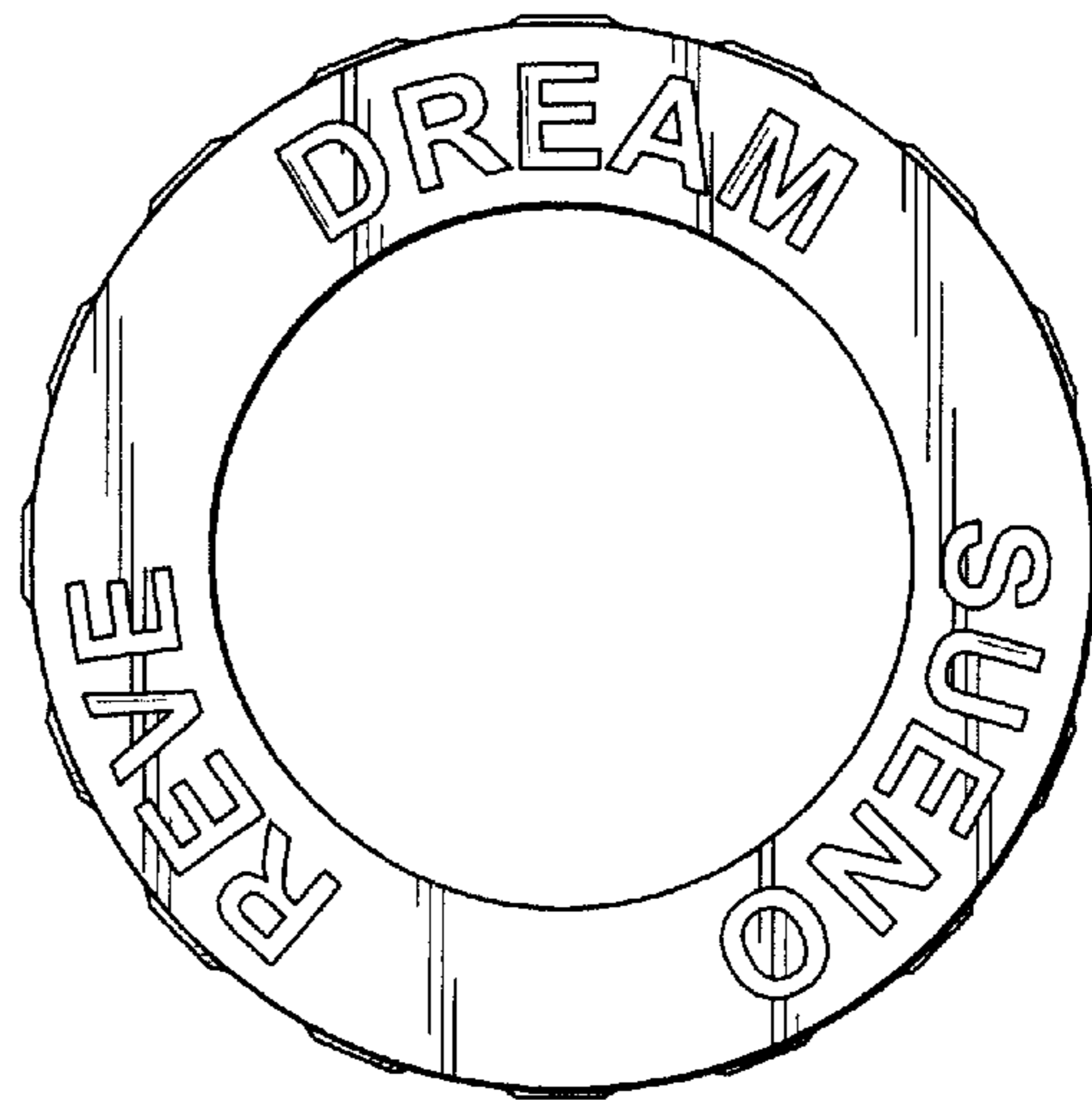

FIG. 170

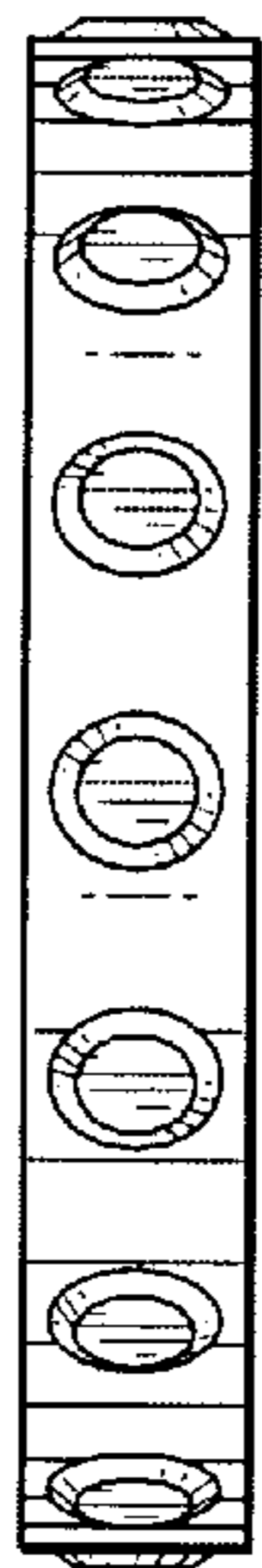

FIG. 171

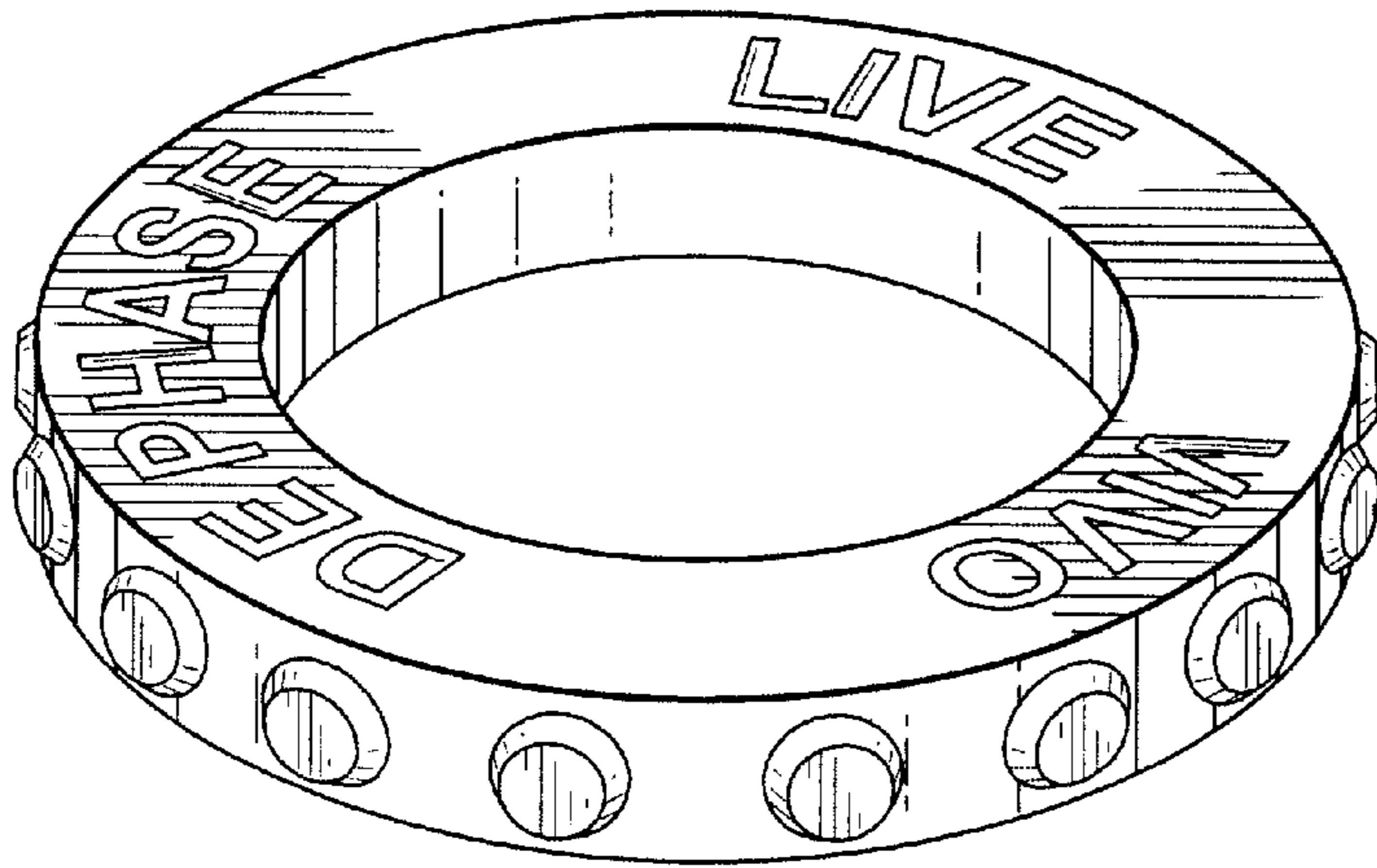

FIG. 172

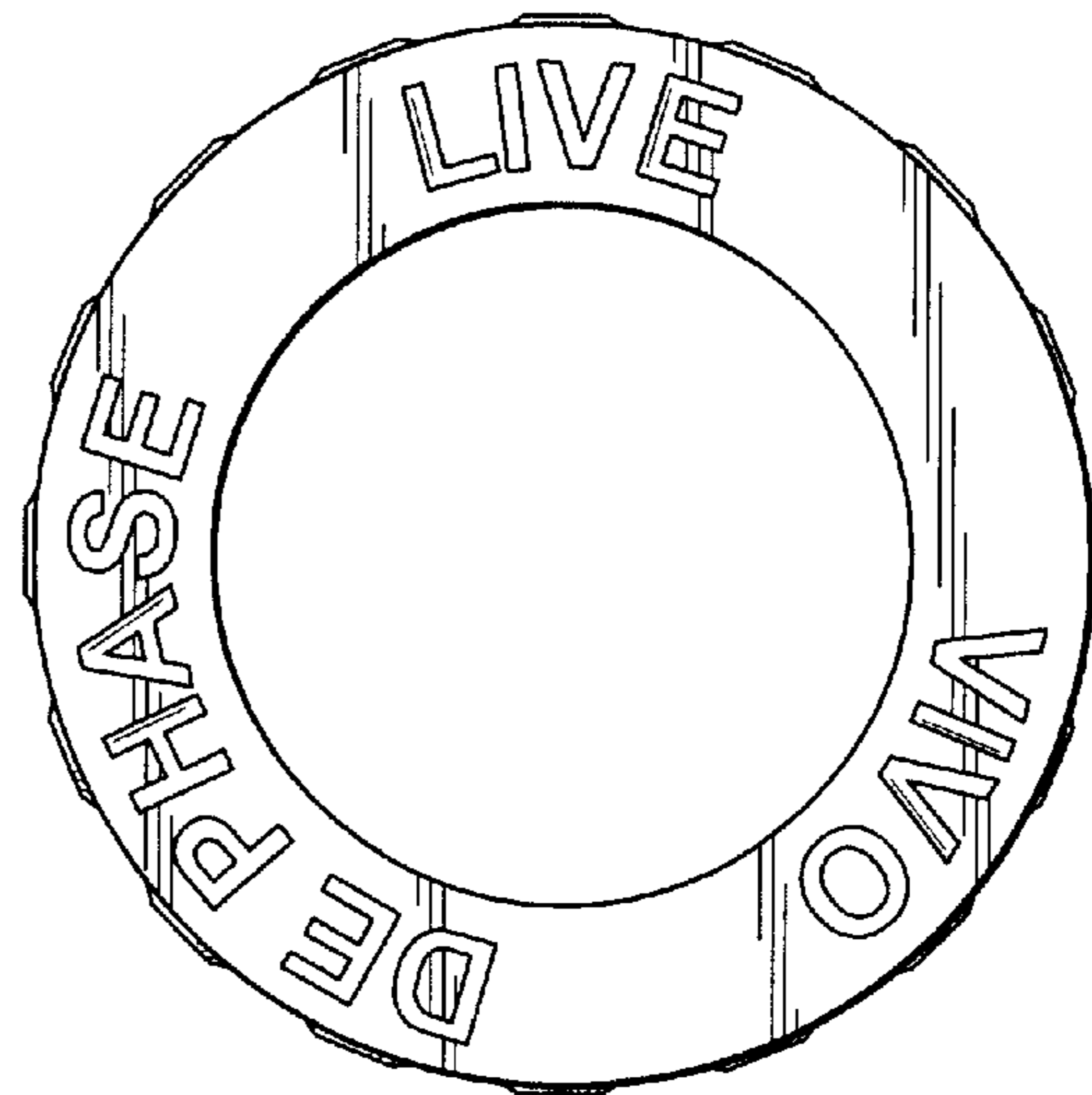

FIG. 173

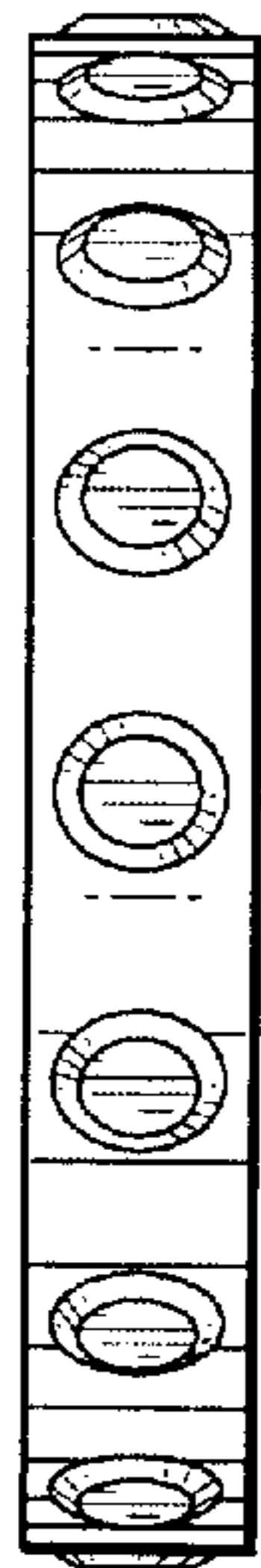

FIG. 174

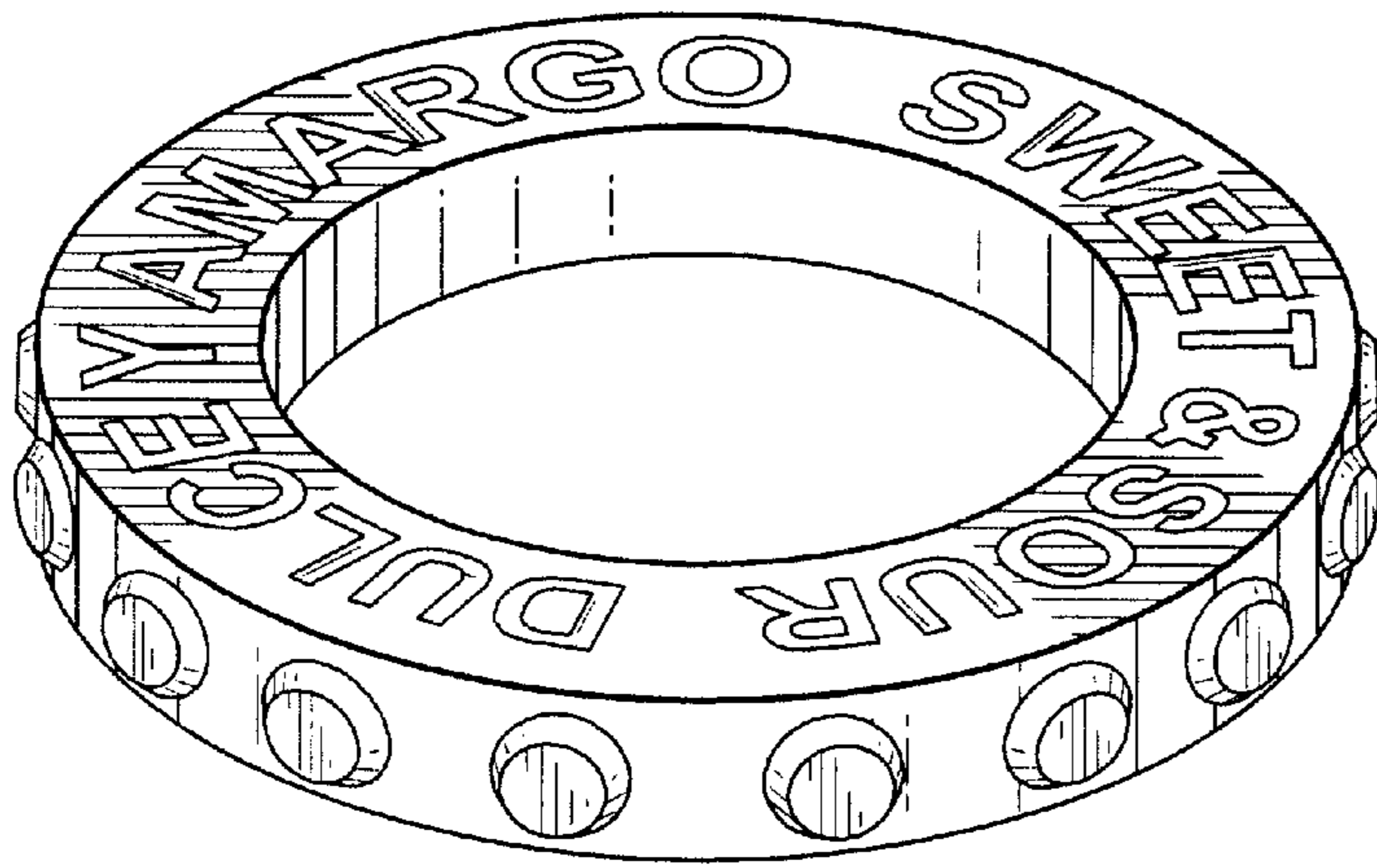

FIG. 175

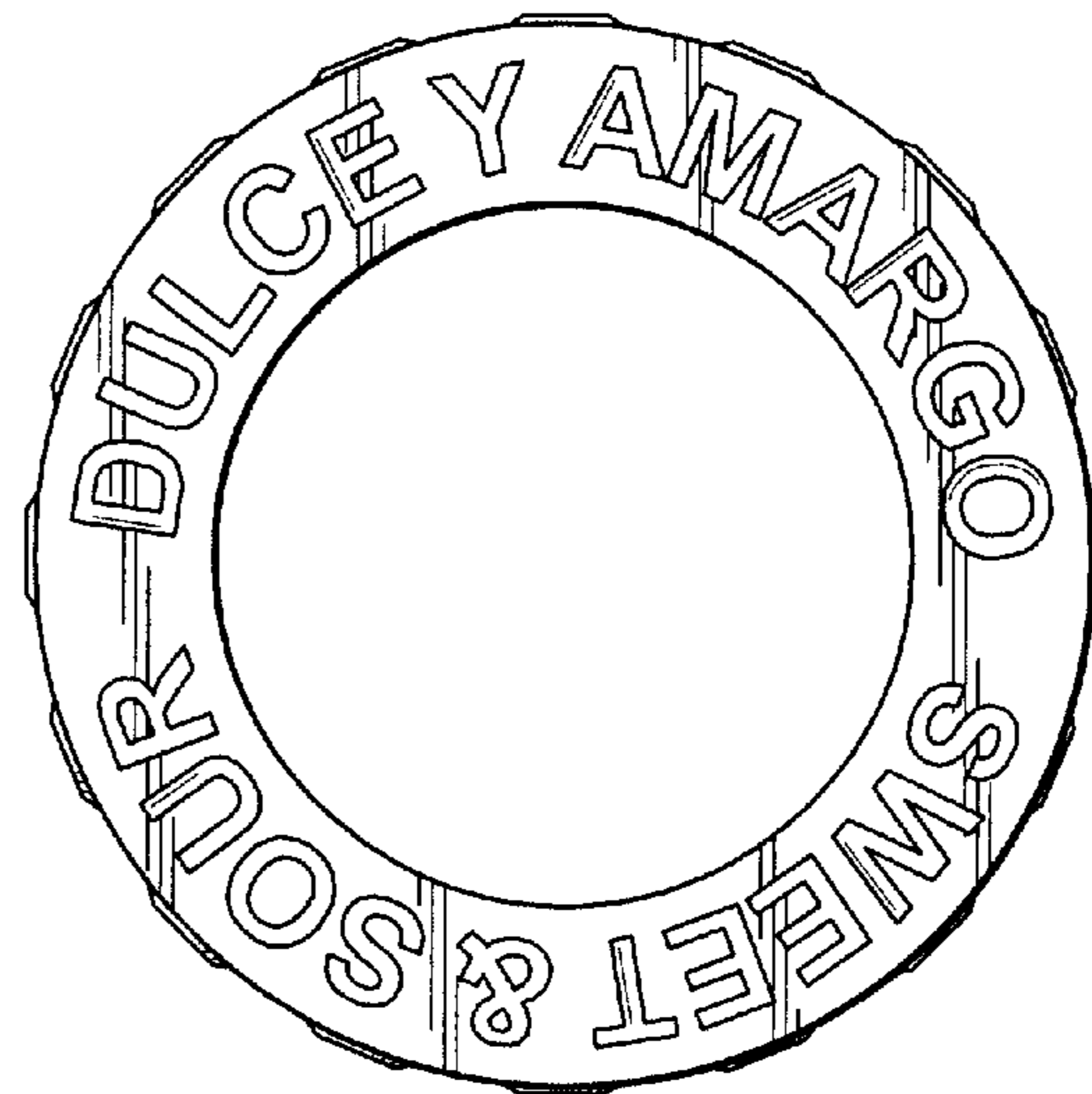

FIG. 176

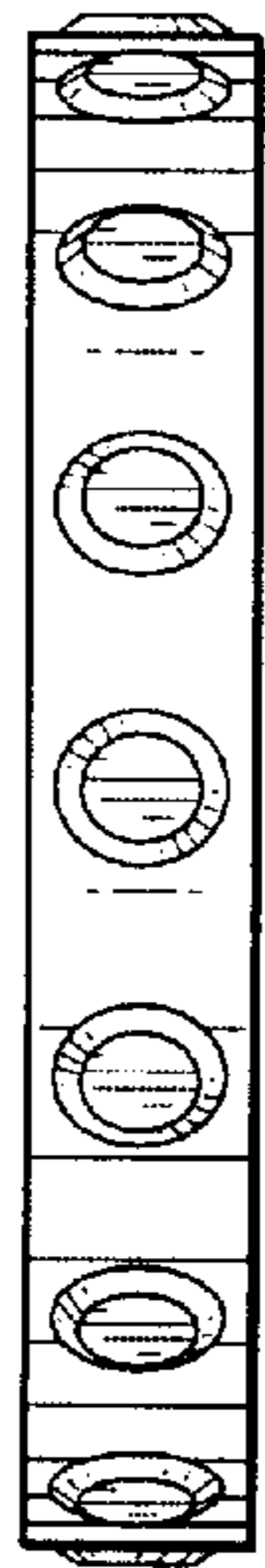

FIG. 177

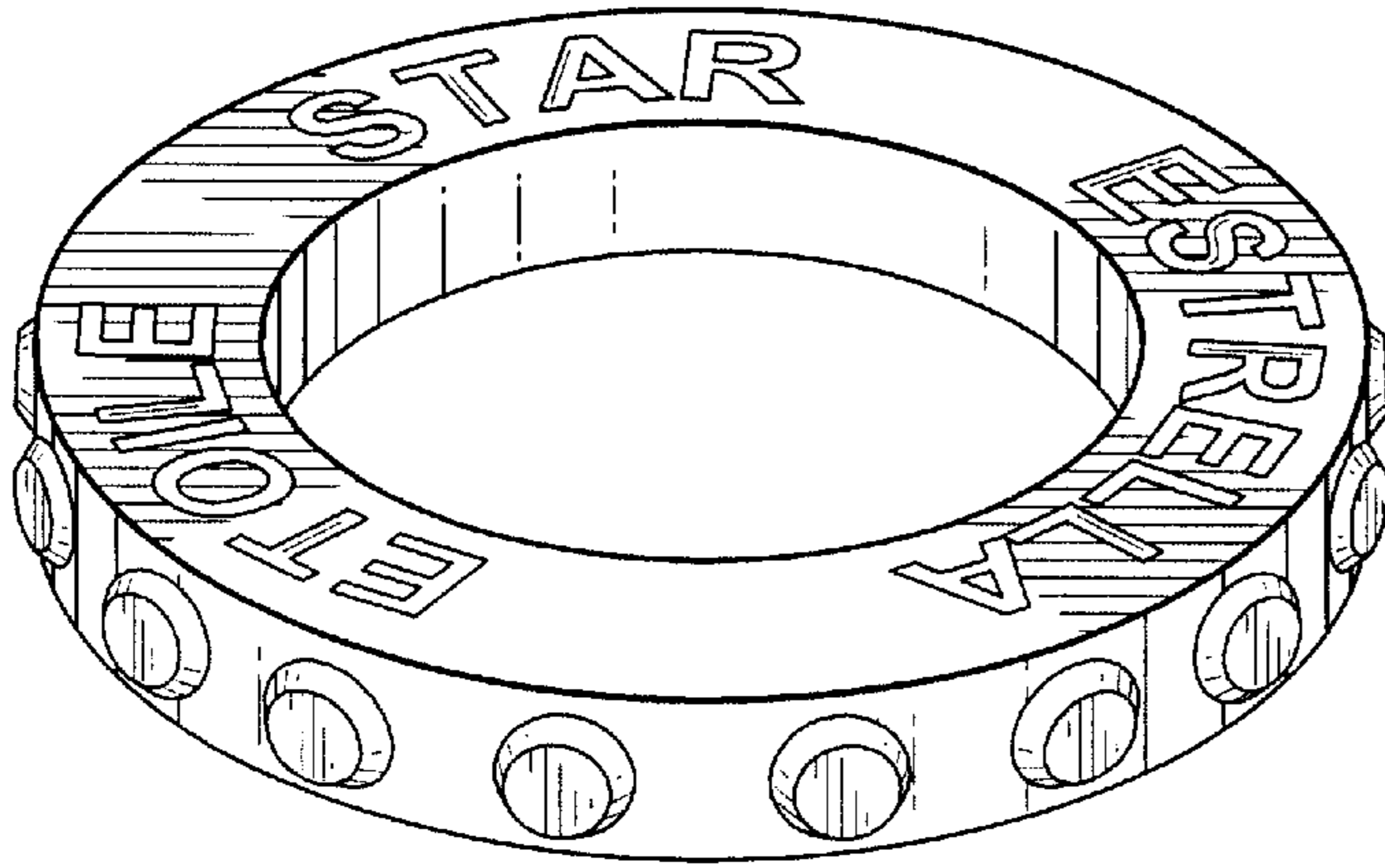

FIG. 178

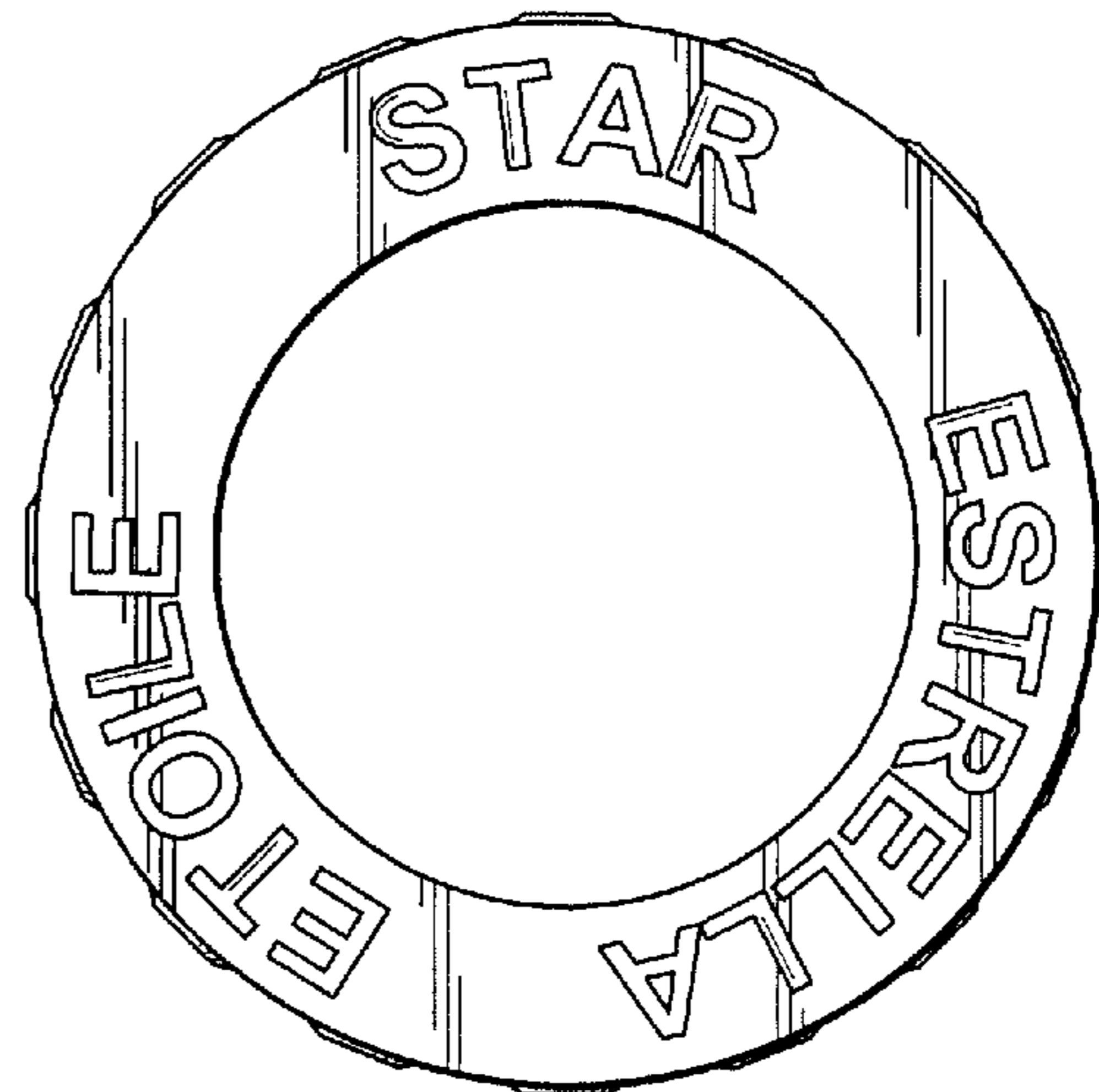

FIG. 179

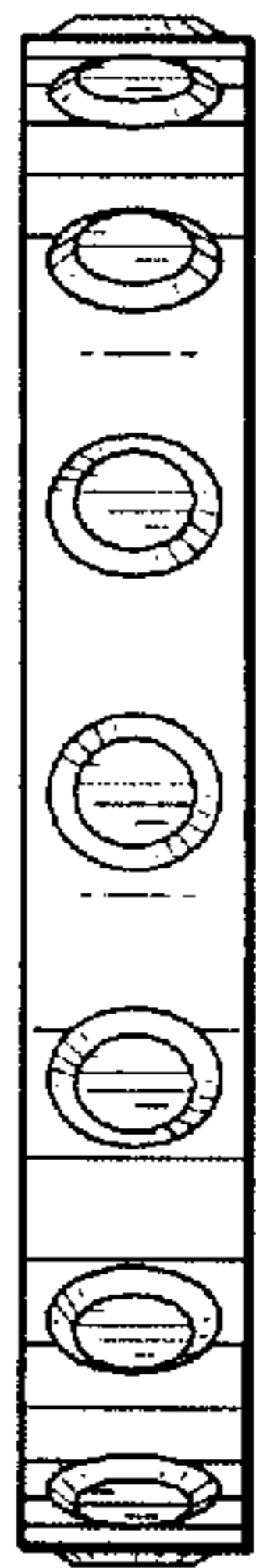

FIG. 180

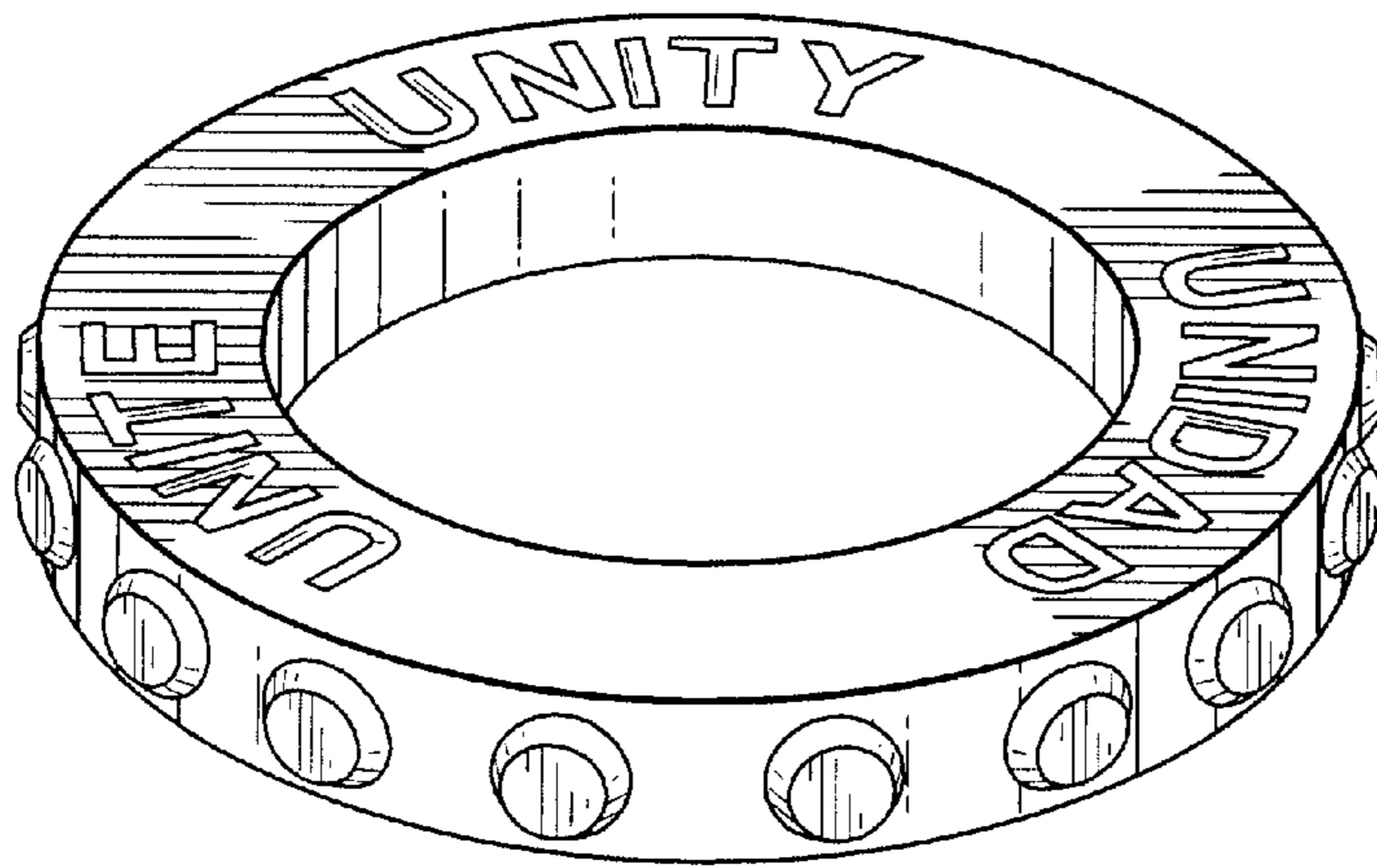

FIG. 181

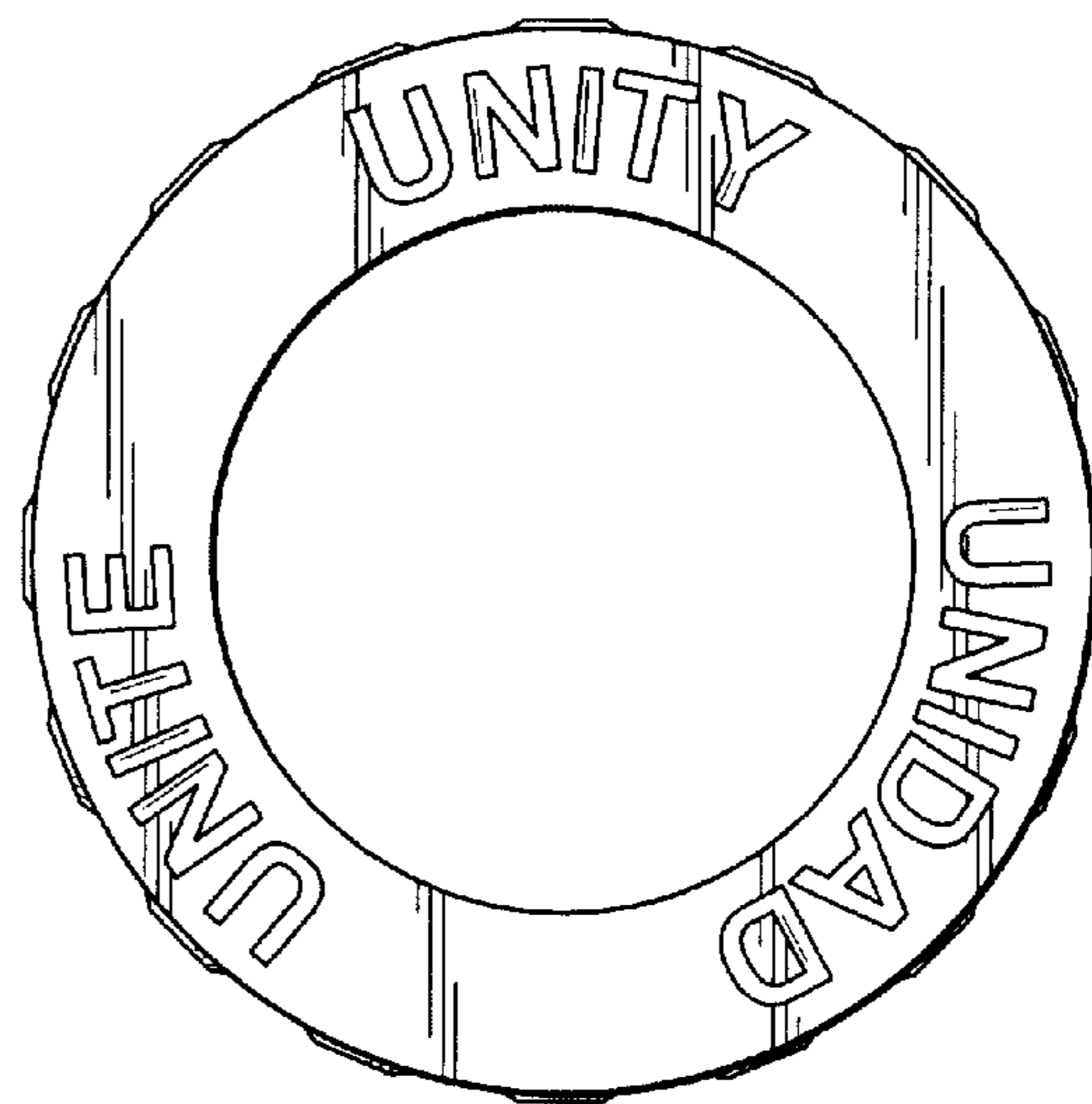

FIG. 182



FIG. 183

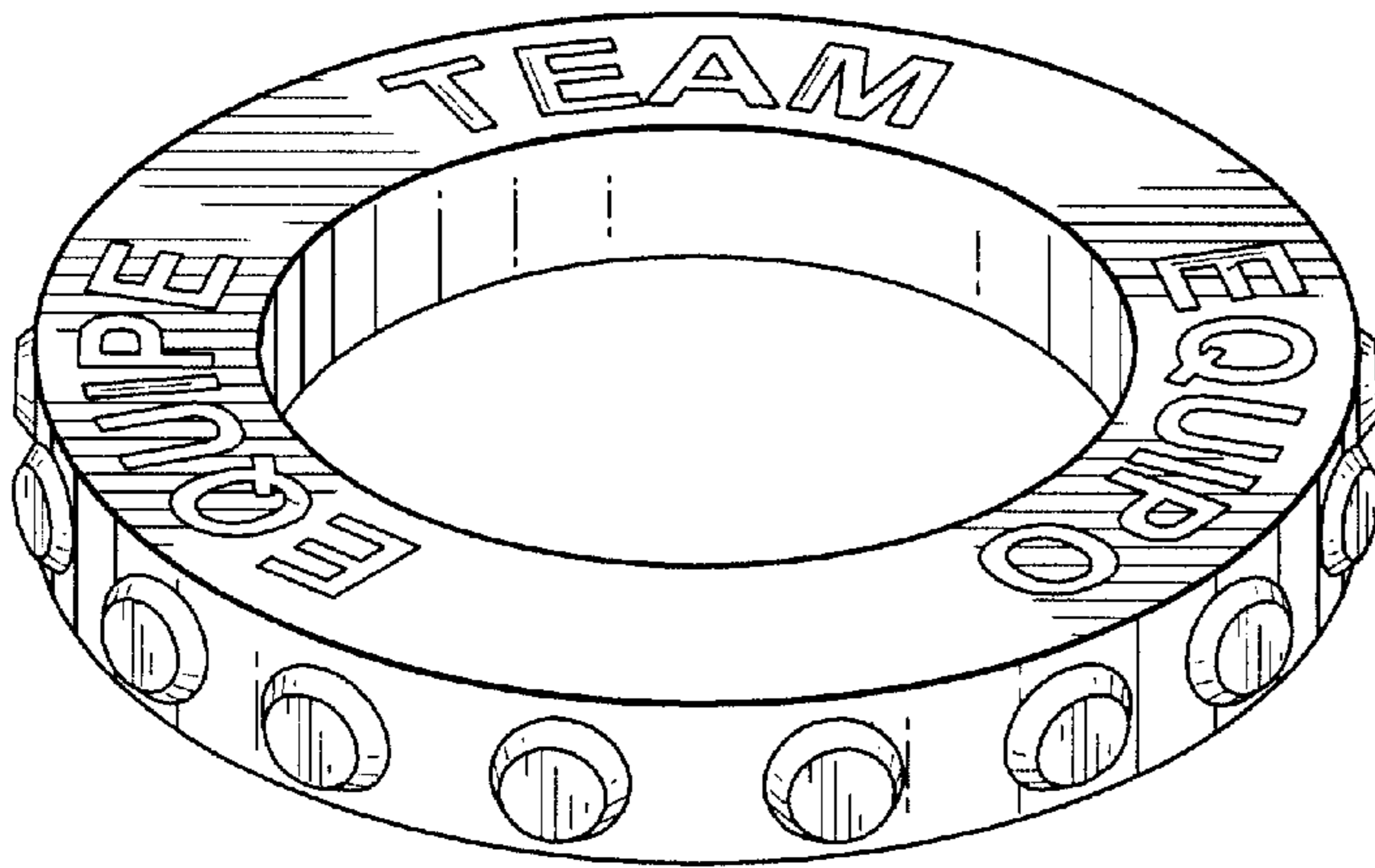

FIG. 184

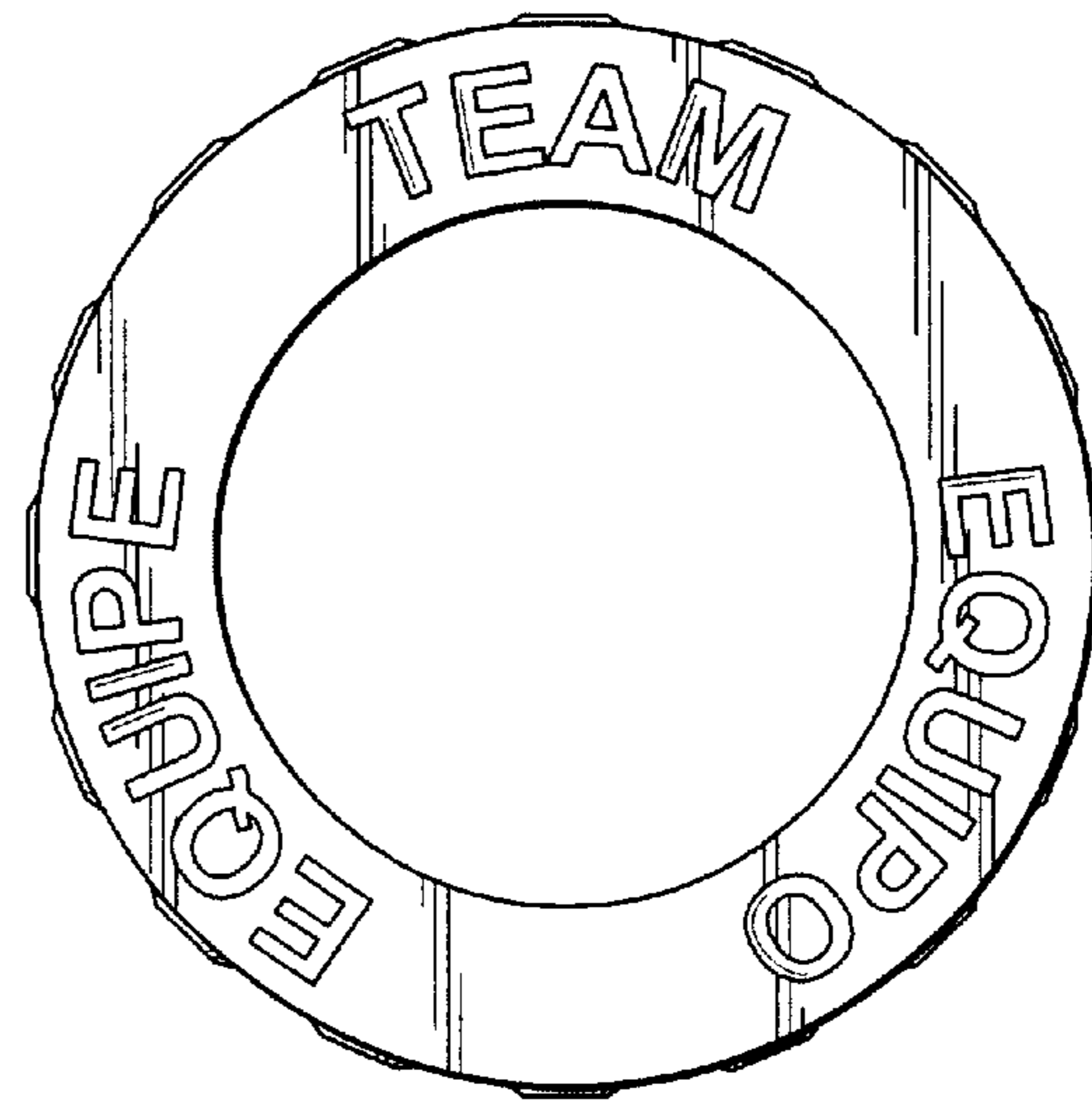

FIG. 185

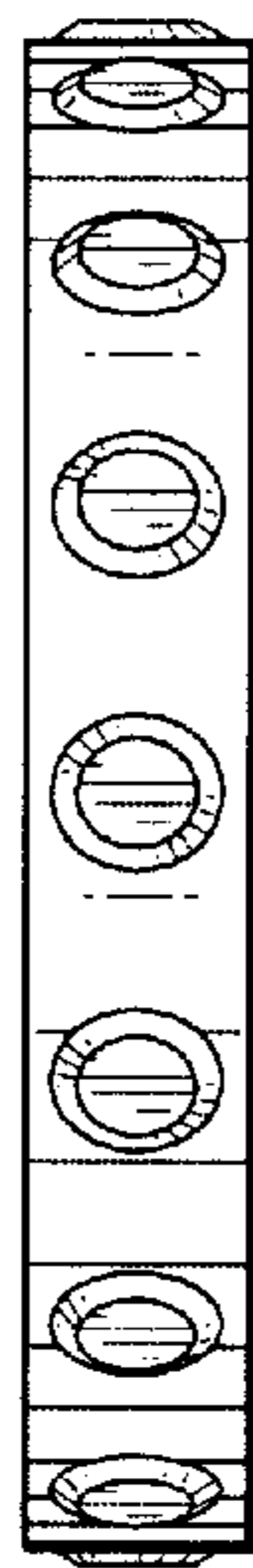

FIG. 186

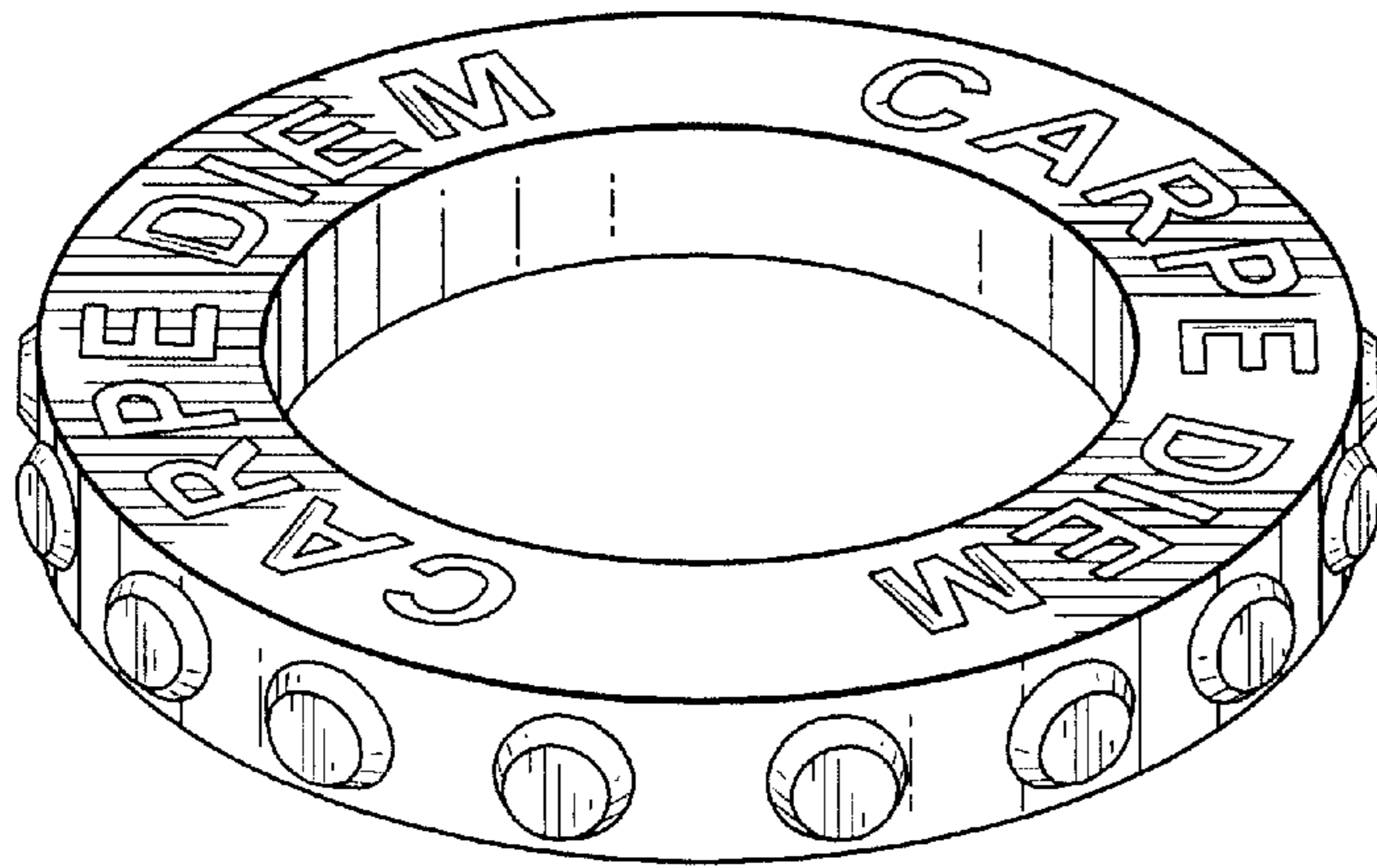

FIG. 187

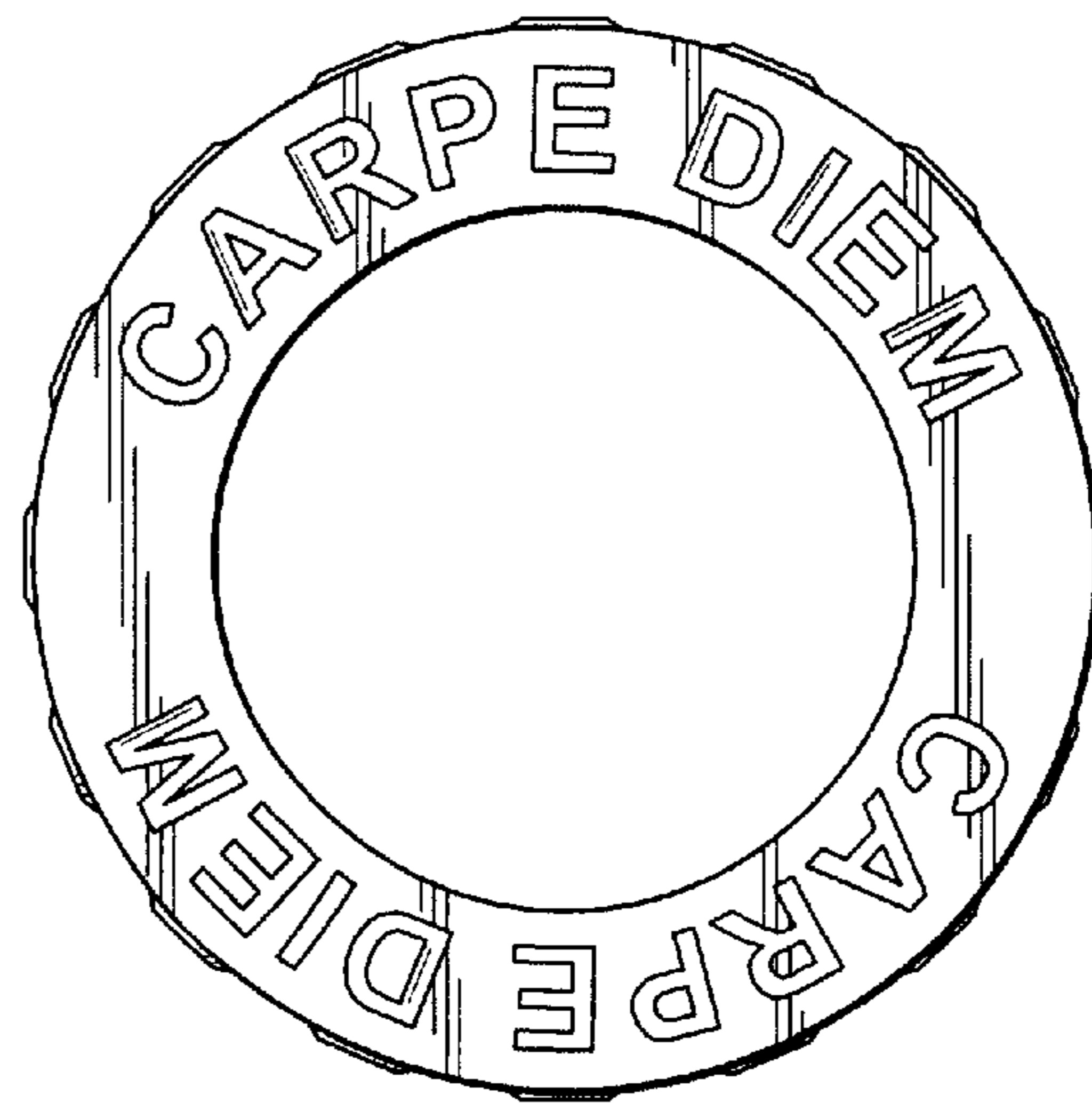

FIG. 188

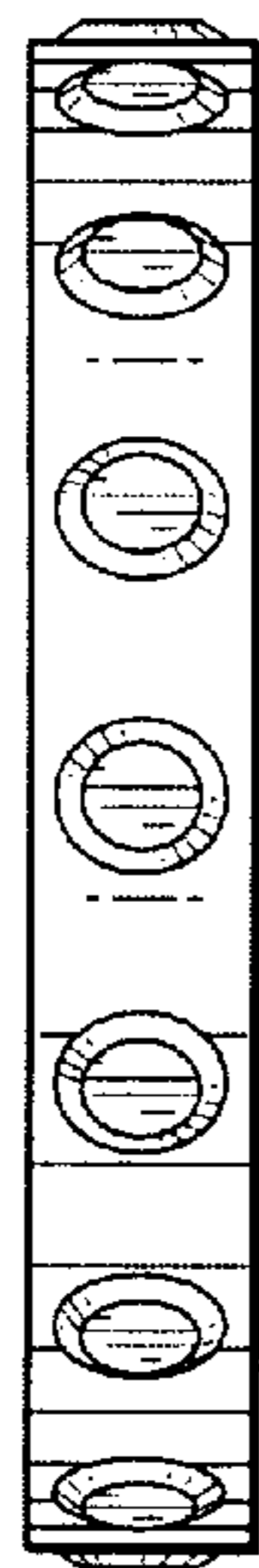

FIG. 189

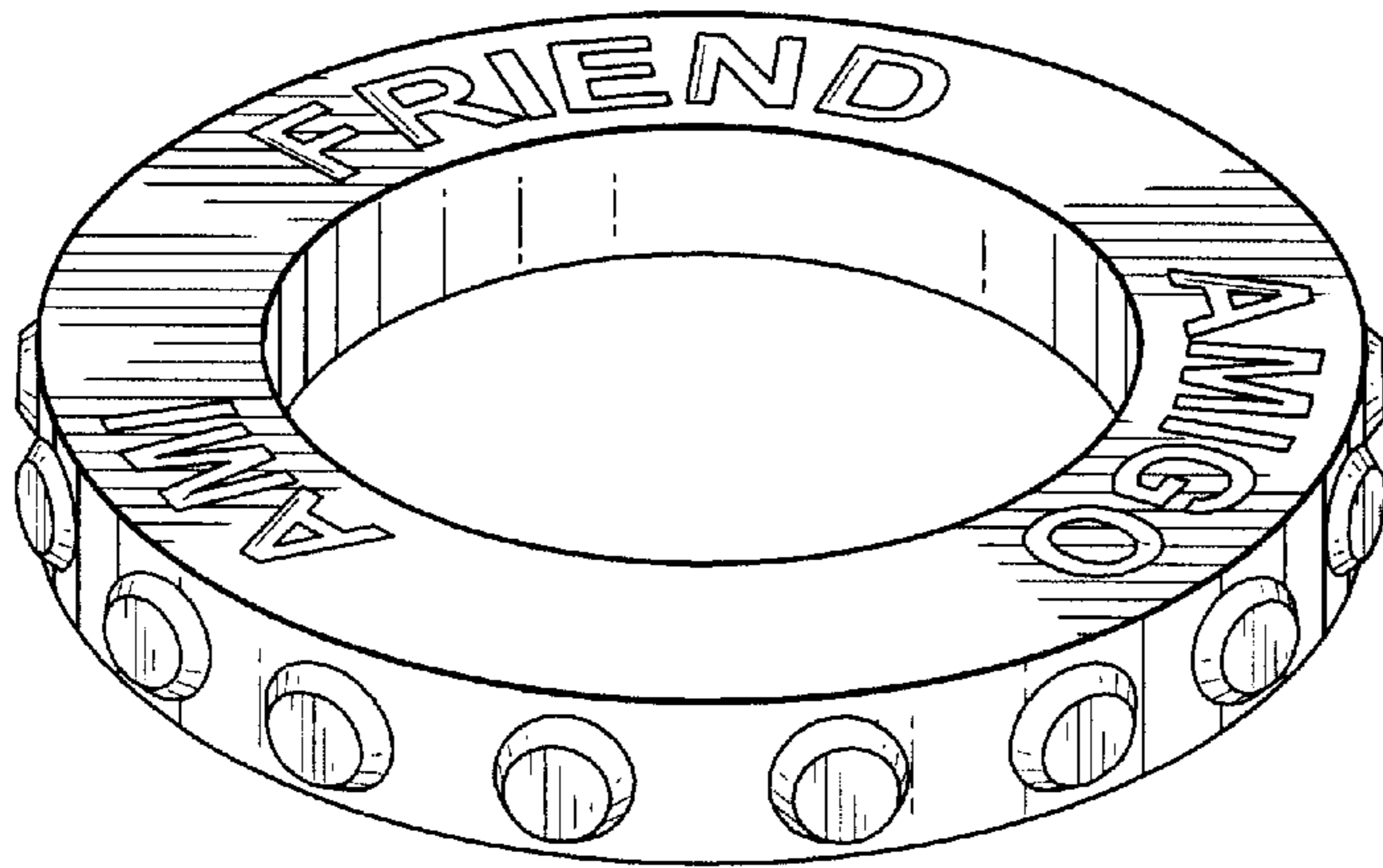

FIG. 190

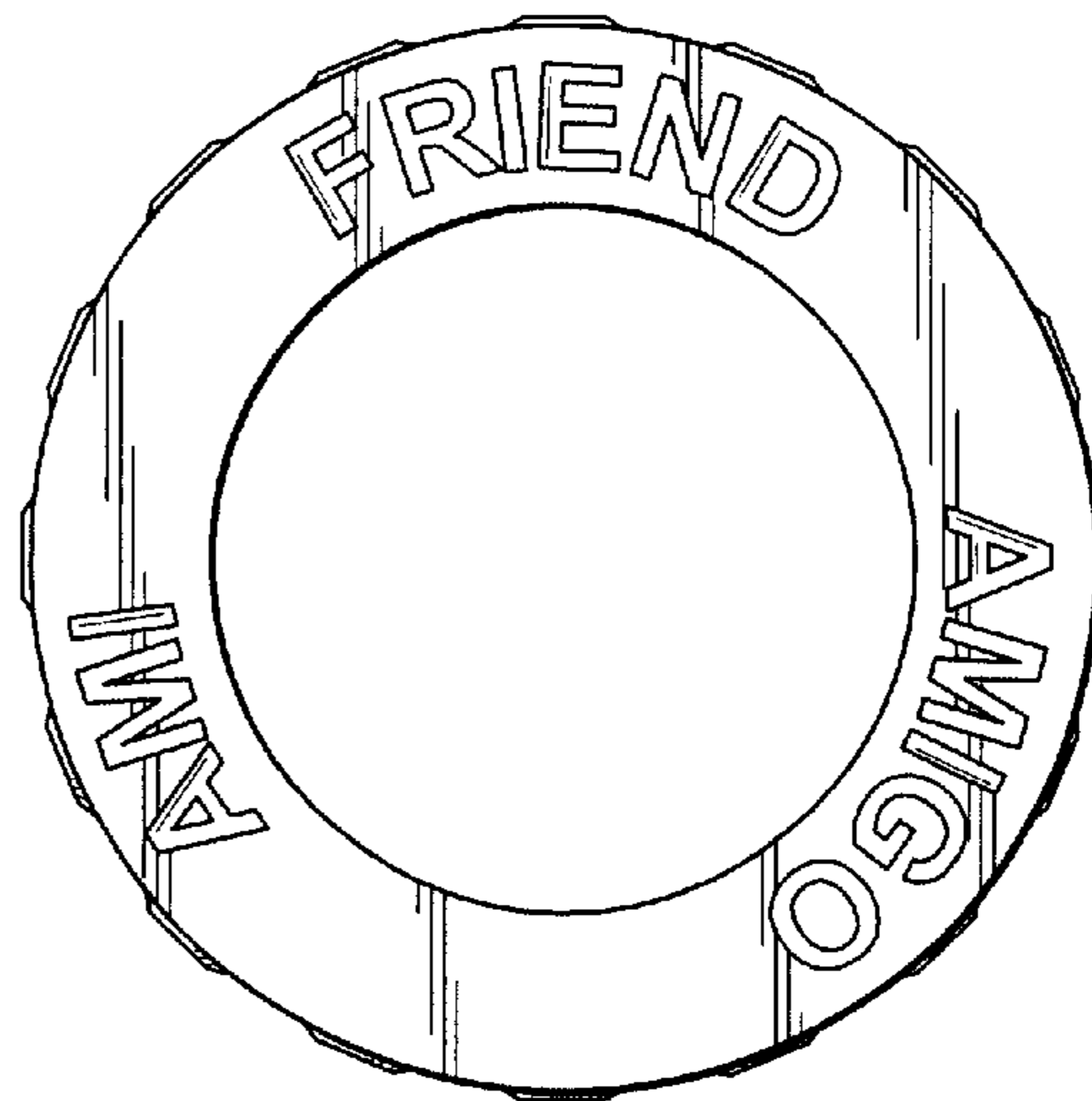

FIG. 191

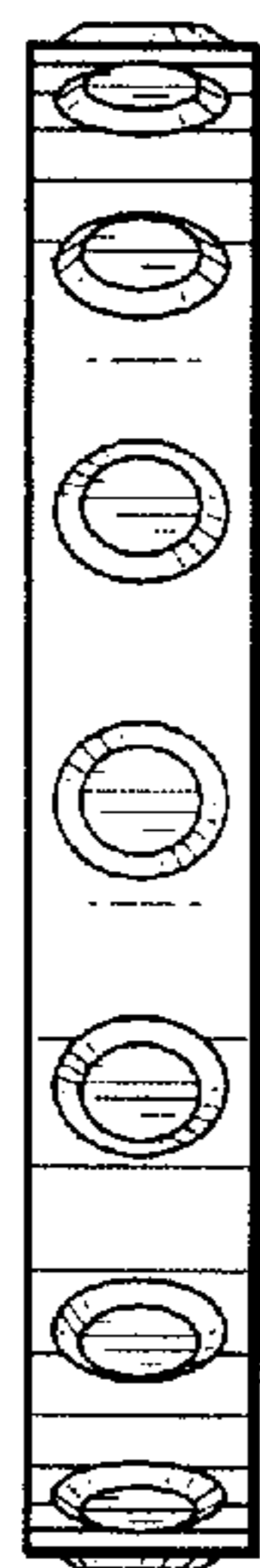

FIG. 192

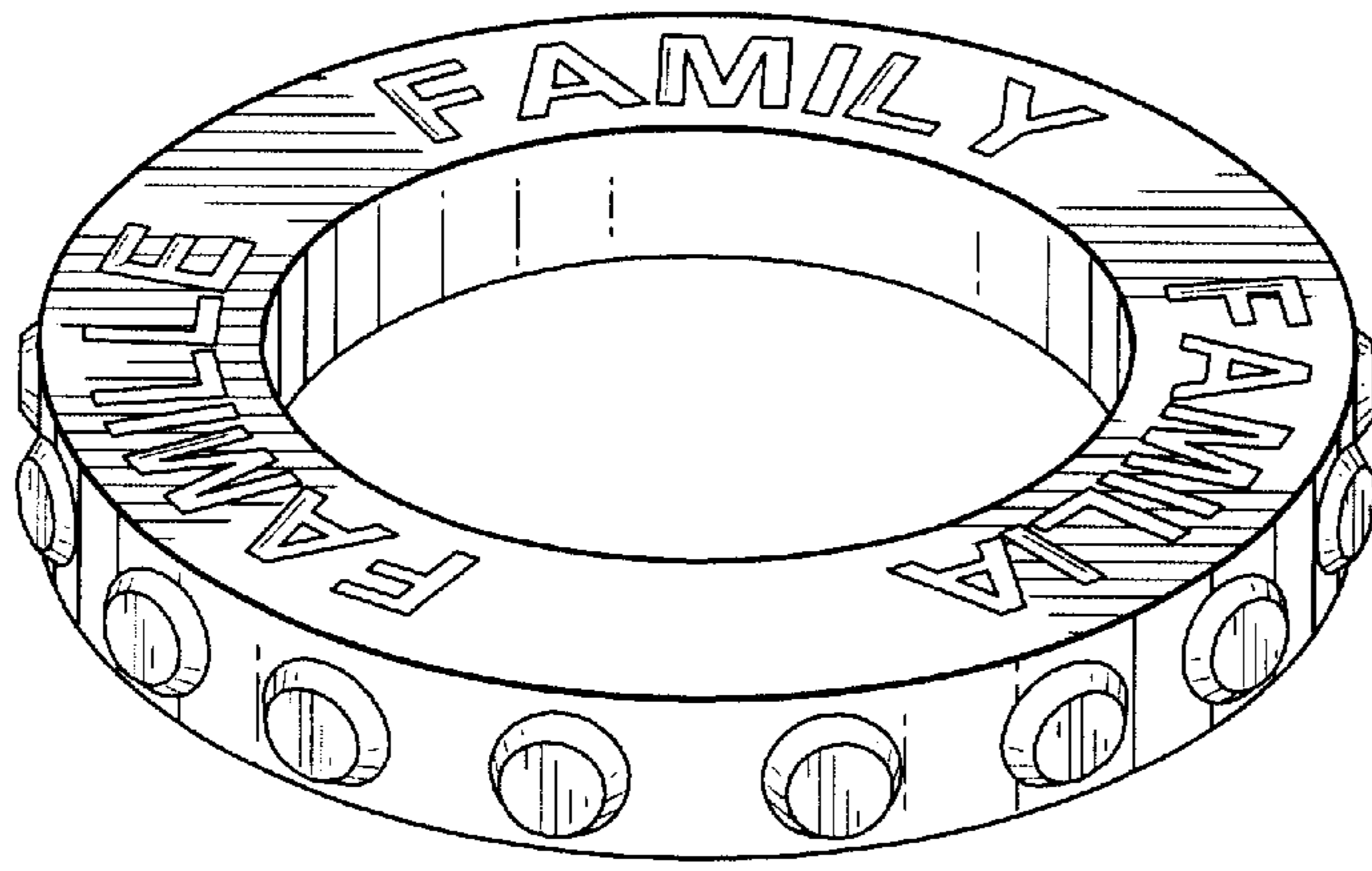

FIG. 193

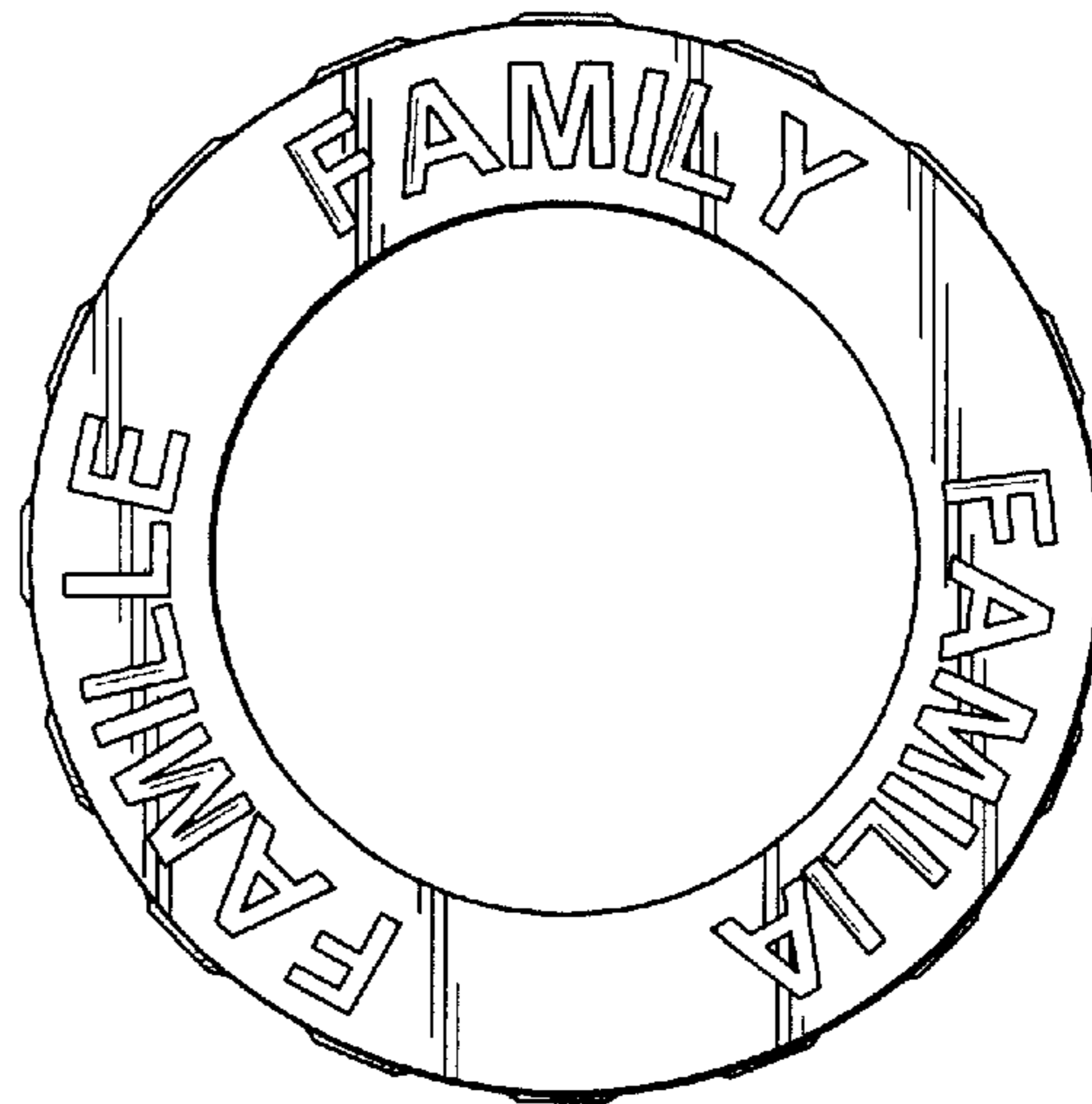

FIG. 194

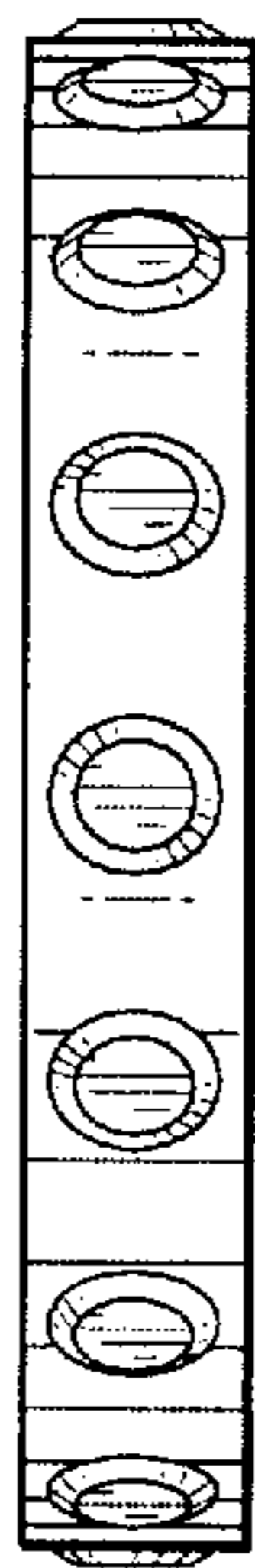

FIG. 195

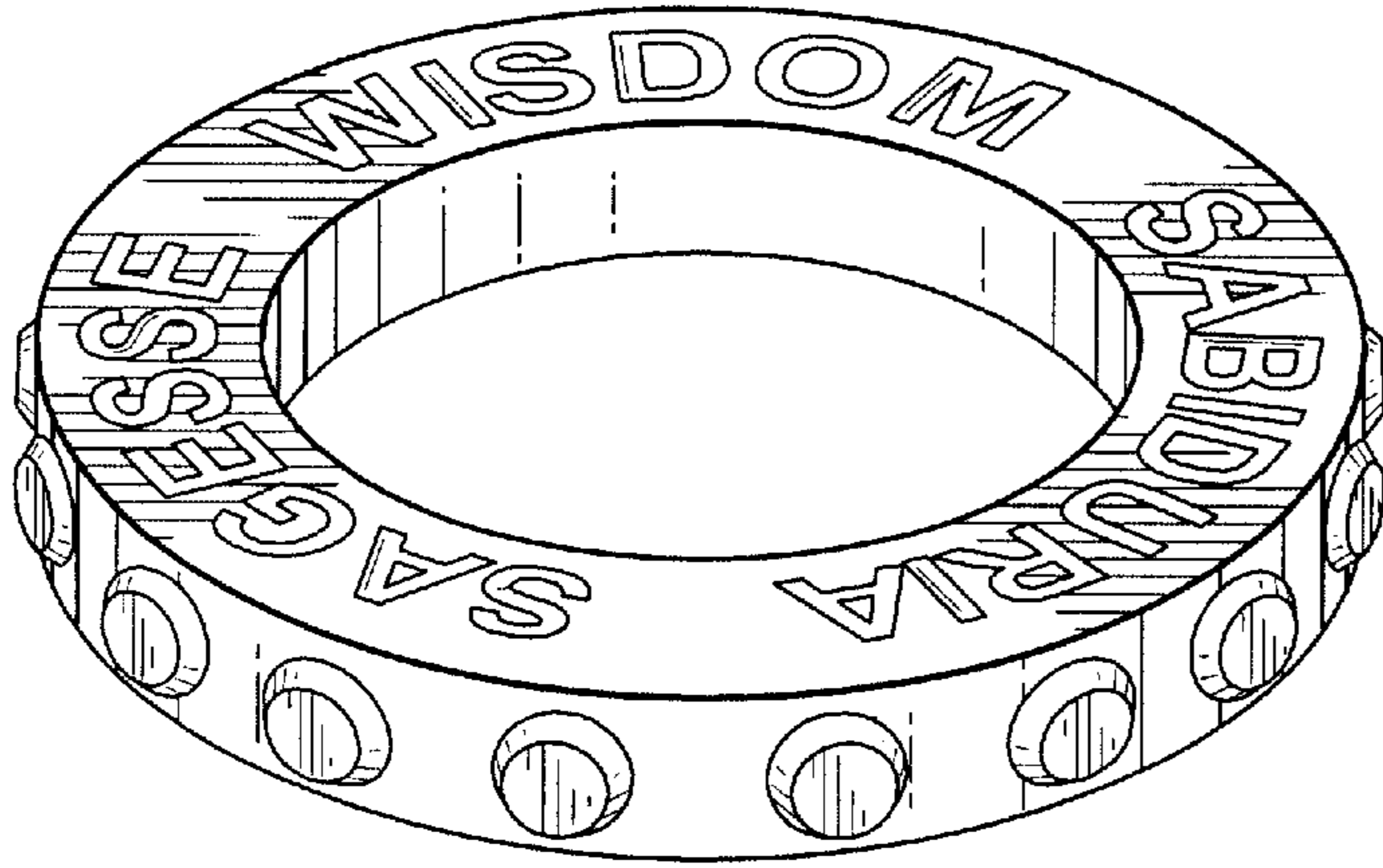

FIG. 196

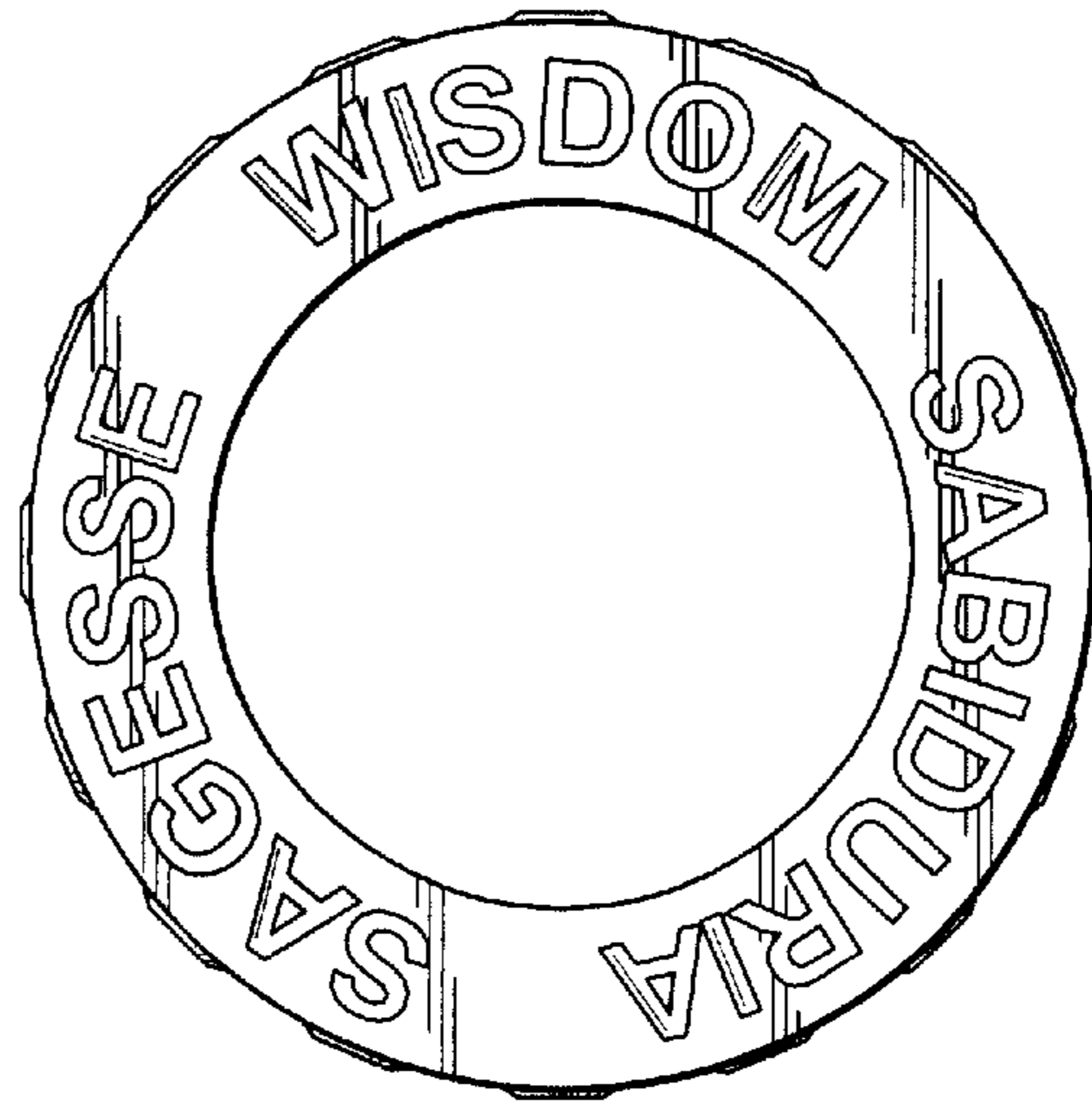

FIG. 197

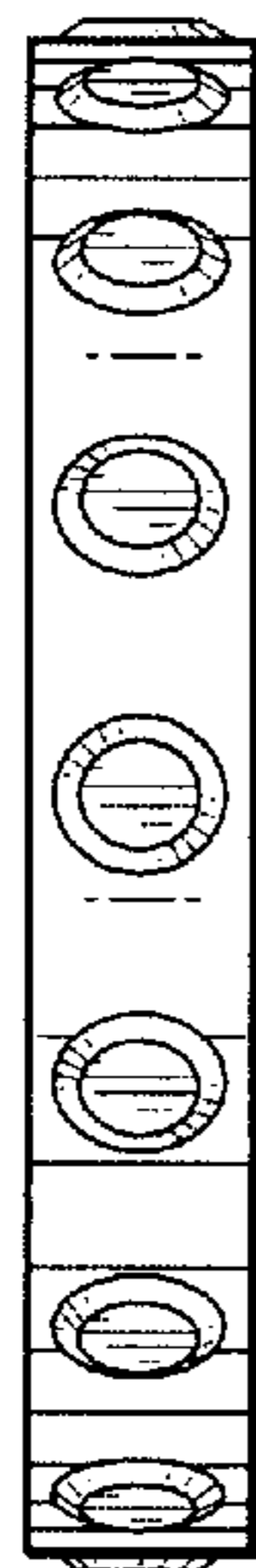

FIG. 198

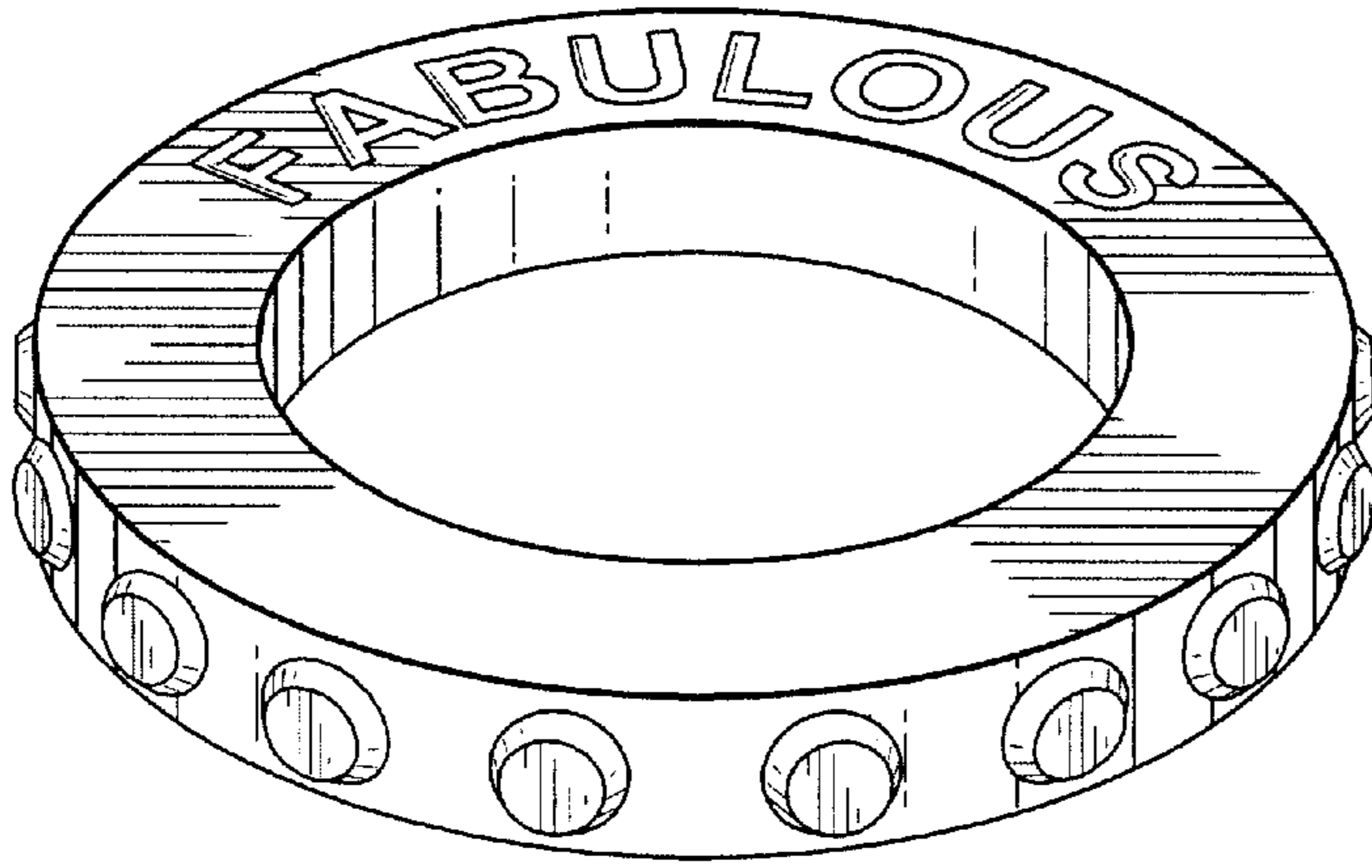

FIG. 199

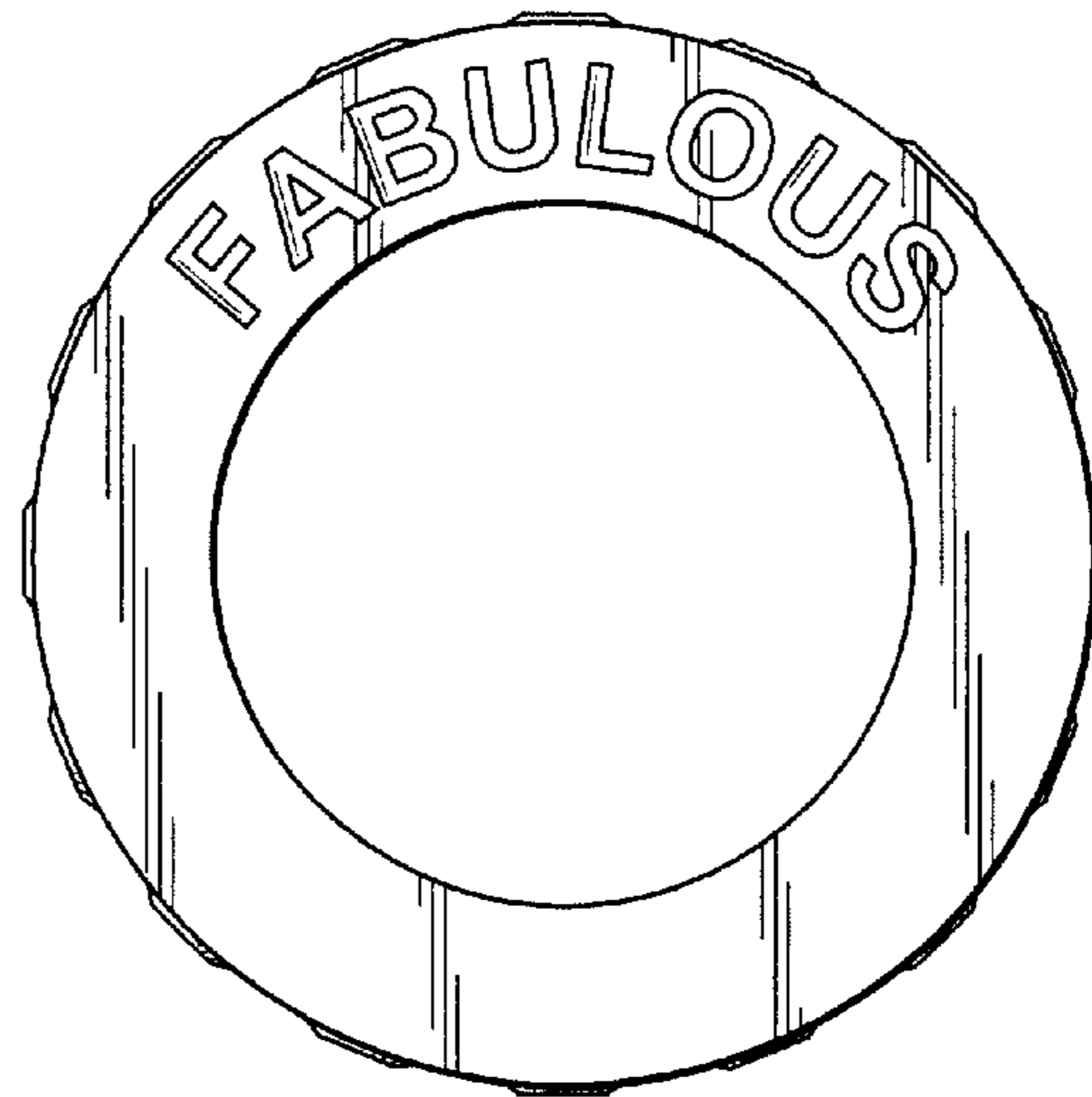

FIG. 200

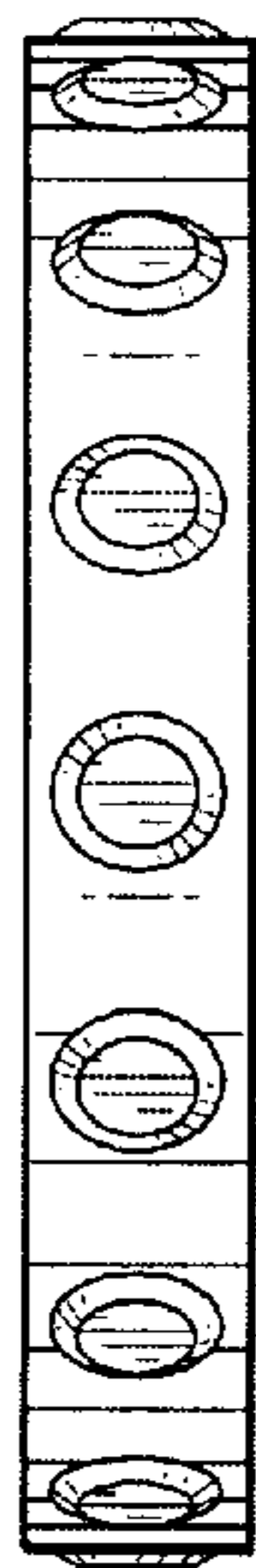

FIG. 201

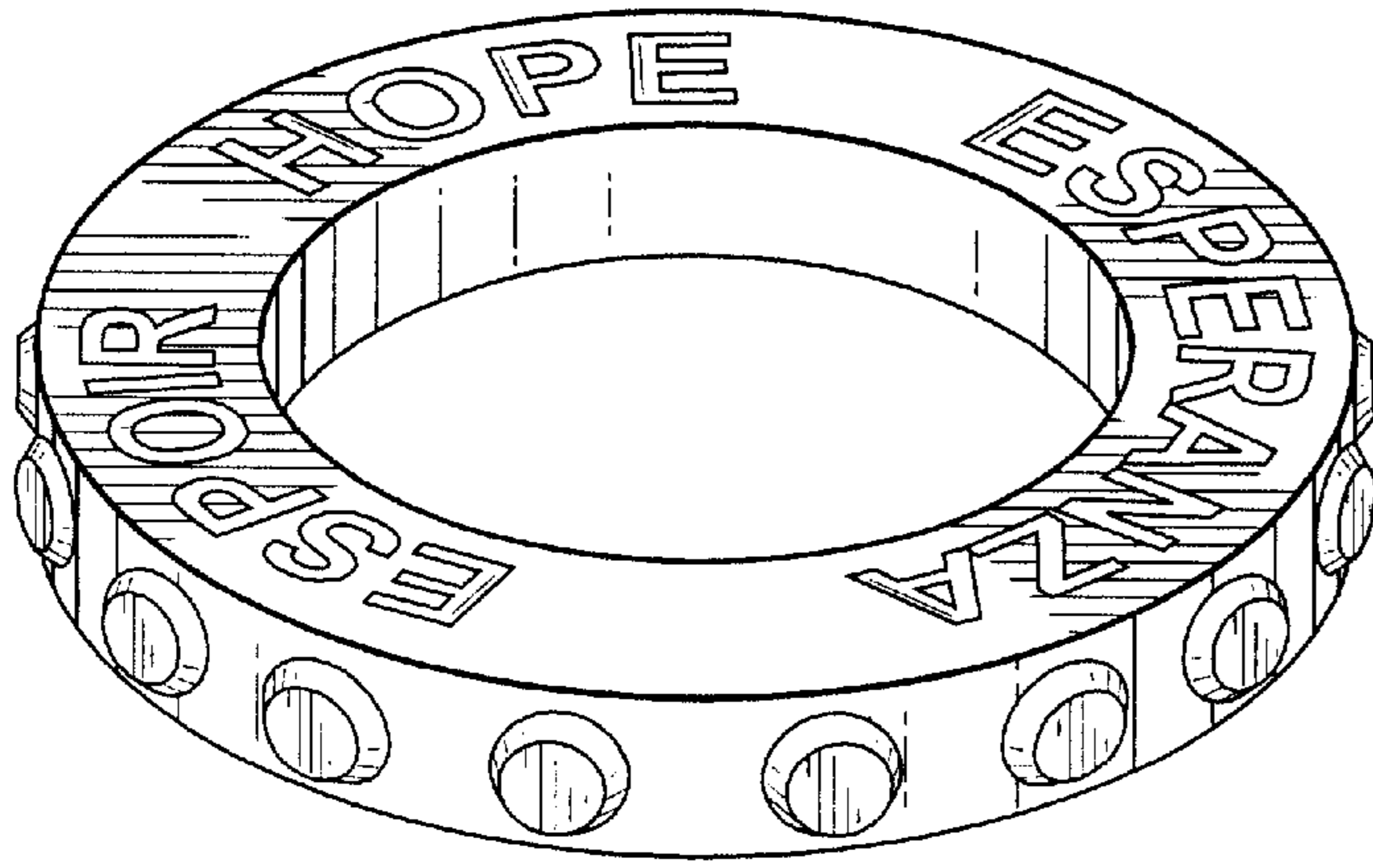

FIG. 202



FIG. 203

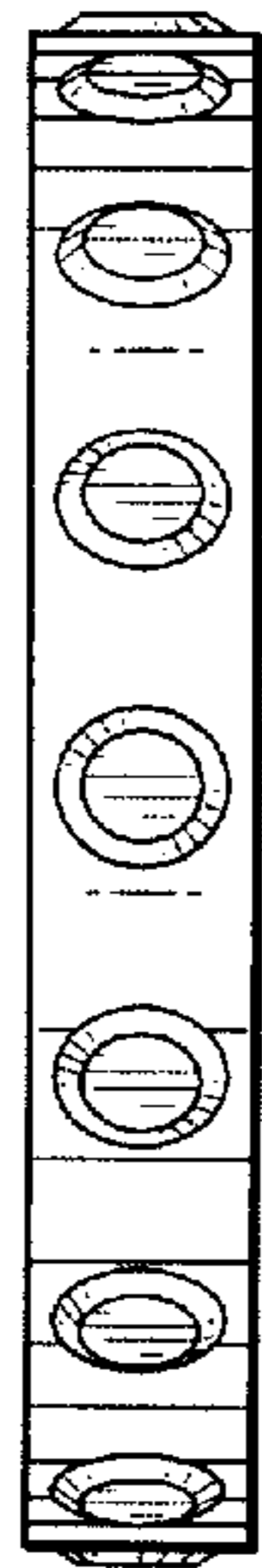

FIG. 204