

US00D542561S

(12) **United States Design Patent**
Ricci

(10) **Patent No.:** **US D542,561 S**
(45) **Date of Patent:** **** May 15, 2007**

(54) **SOFA**
(75) Inventor: **Luca Ricci**, Bertinoro-Fc (IT)
(73) Assignee: **DeCoro Limited**, Hong Kong (HK)
(**) Term: **14 Years**

D489,544 S * 5/2004 Nastri D6/381
D494,376 S * 8/2004 Natuzzi D6/381
D498,941 S * 11/2004 Ricci D6/381
D499,264 S * 12/2004 Ricci D6/381
6,826,789 B1 * 12/2004 Choi 5/12.1
D504,247 S * 4/2005 Ricci D6/381
D511,422 S * 11/2005 Nastri D6/381
D514,840 S * 2/2006 Ghetti D6/381
D519,296 S * 4/2006 Ghetti D6/381

(21) Appl. No.: **29/233,773**
(22) Filed: **Jul. 8, 2005**

* cited by examiner

(30) **Foreign Application Priority Data**

Primary Examiner—Sandra Snapp
(74) *Attorney, Agent, or Firm*—Fish & Neave IP Group
Ropes & Gray LLP

Apr. 8, 2005 (CN) 200530007991

(51) **LOC (8) Cl.** **06-01**
(52) **U.S. Cl.** **D6/381**
(58) **Field of Classification Search** D6/334,
D6/335, 337, 357, 361, 364, 367, 371, 378,
D6/381, 382, 383, 393, 500–503; 297/62–63,
297/38, 118, 232–233, 244–245, 311, 445.1,
297/446.1; 5/12.1, 28, 42
See application file for complete search history.

(57) **CLAIM**

I claim the ornamental design for a sofa, as shown and described.

DESCRIPTION

FIG. 1 is a front perspective view my new sofa design;
FIG. 2 is a side perspective view thereof;
FIG. 3 is a side perspective view thereof;
FIG. 4 is a rear perspective view thereof;
FIG. 5 is a front perspective view thereof; and,
FIG. 6 is a top view thereof.

(56) **References Cited**

U.S. PATENT DOCUMENTS

D253,326 S * 11/1979 Brukoff D6/377
D488,315 S * 4/2004 Natuzzi D6/381

1 Claim, 6 Drawing Sheets

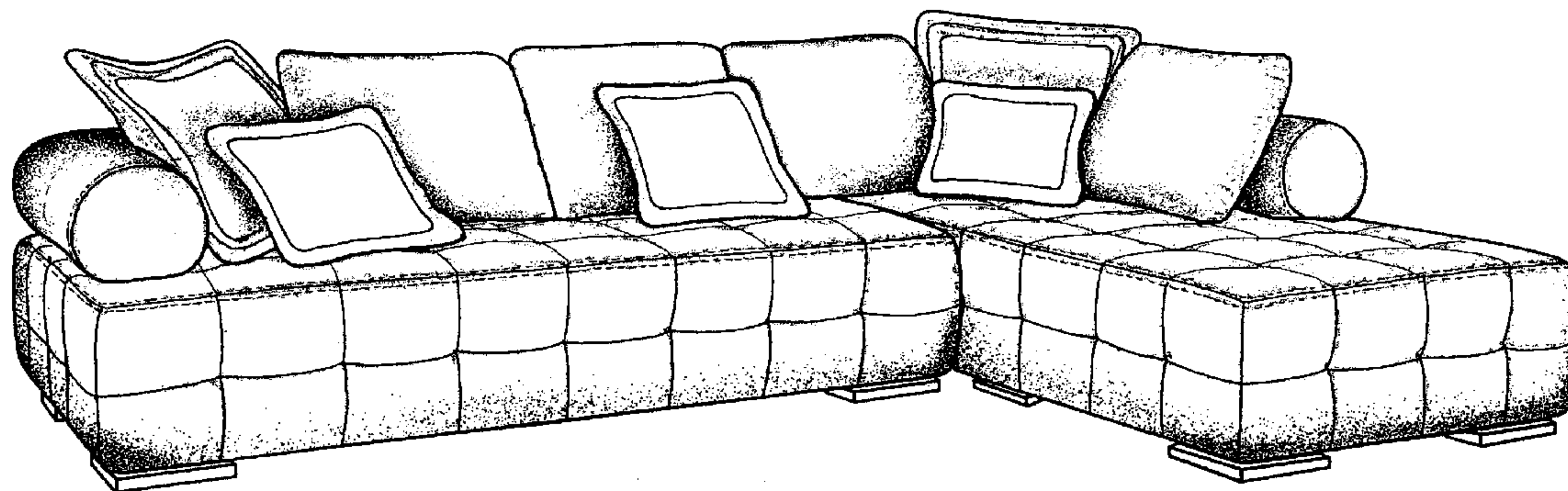

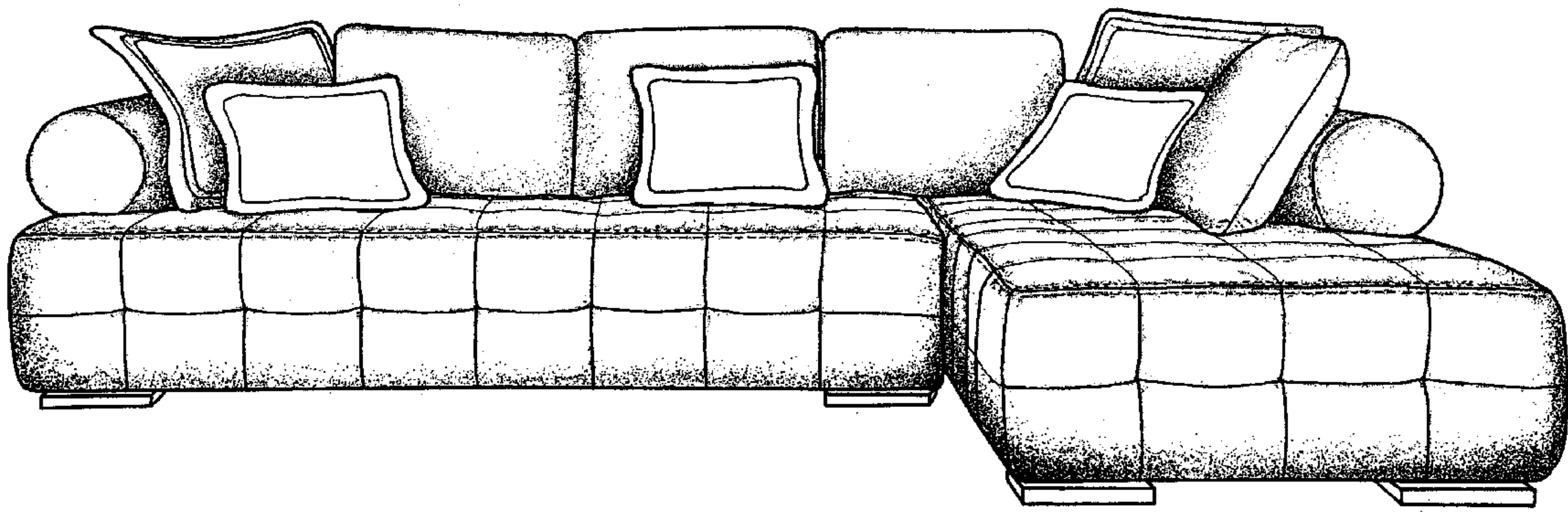

Figure 1

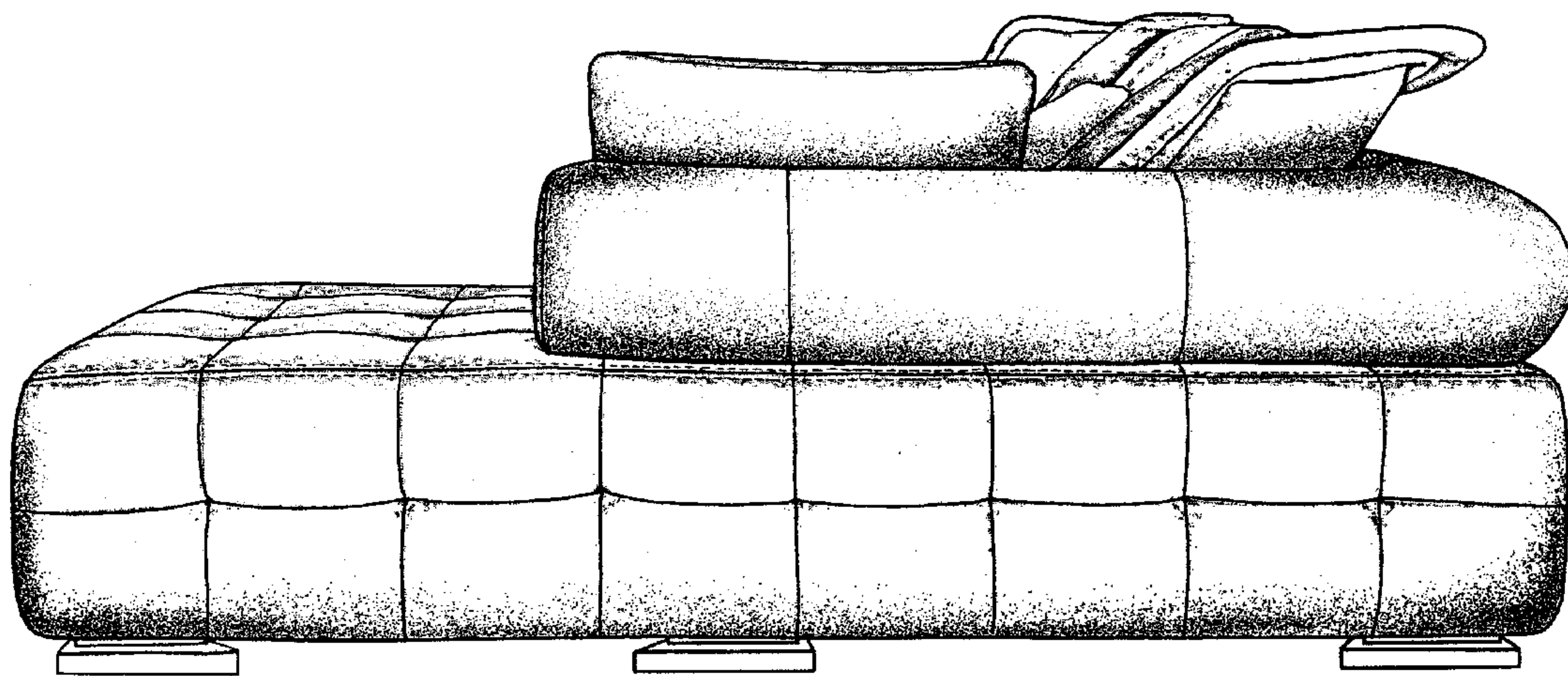

Figure 2

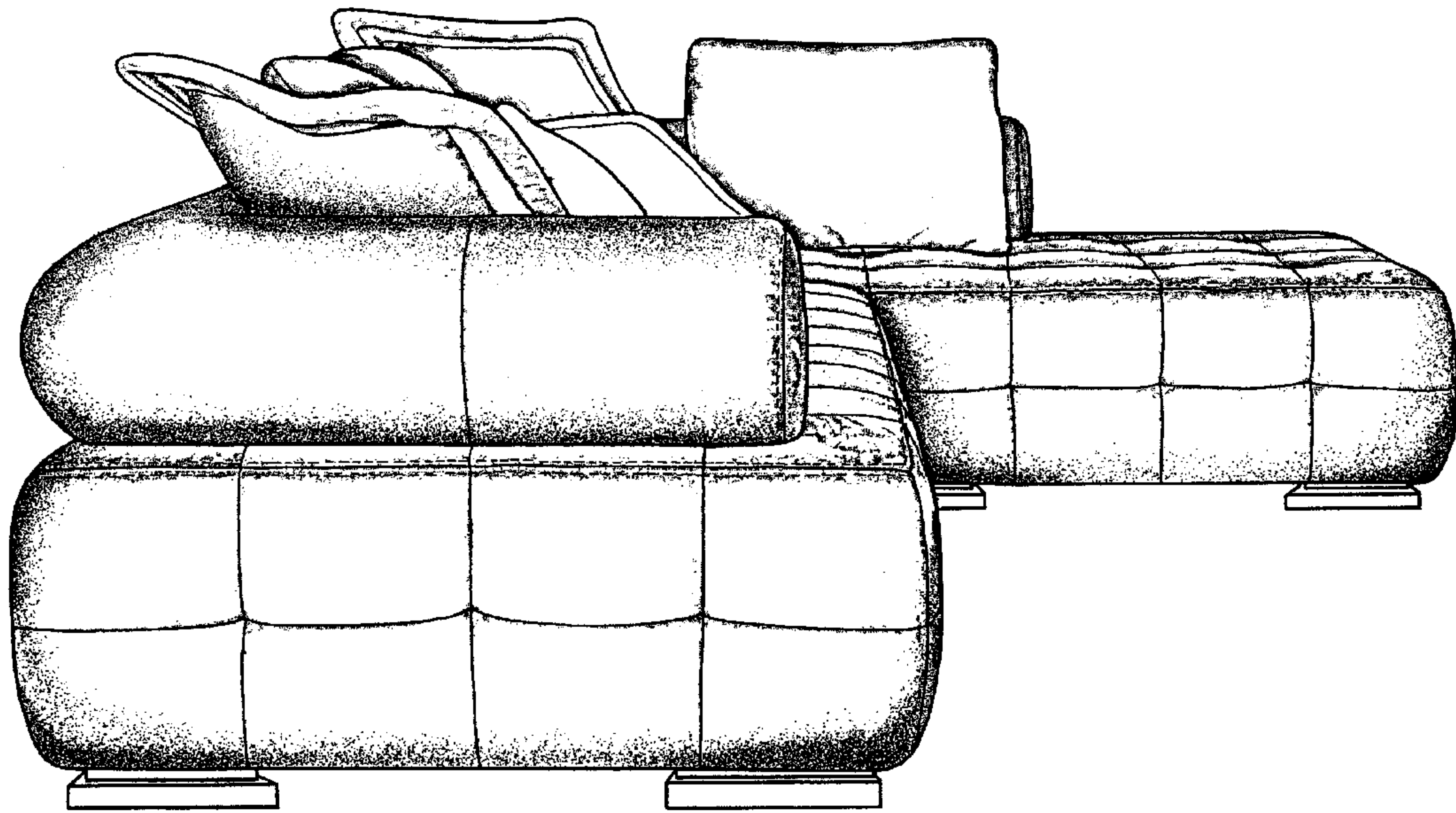

Figure 3

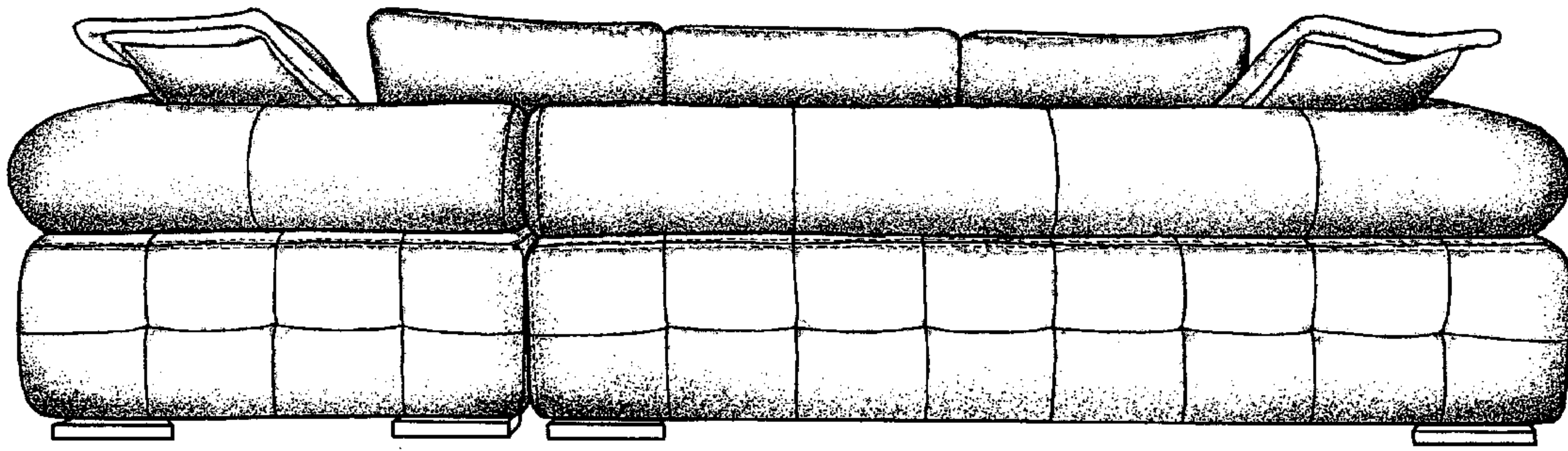

Figure 4

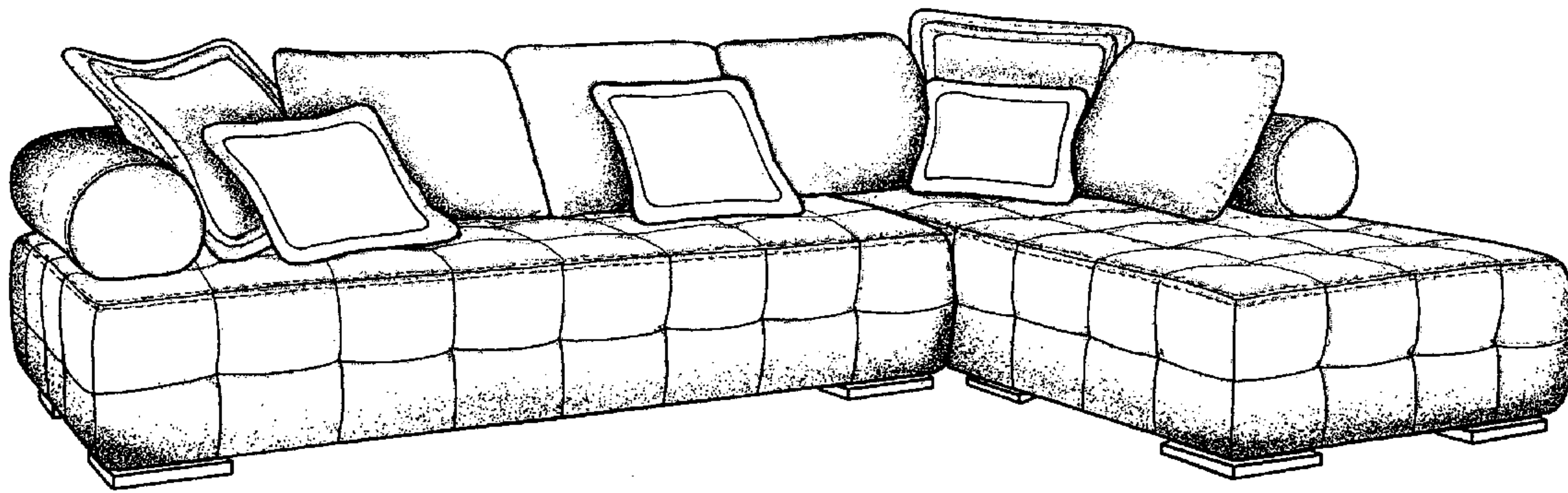

Figure 5

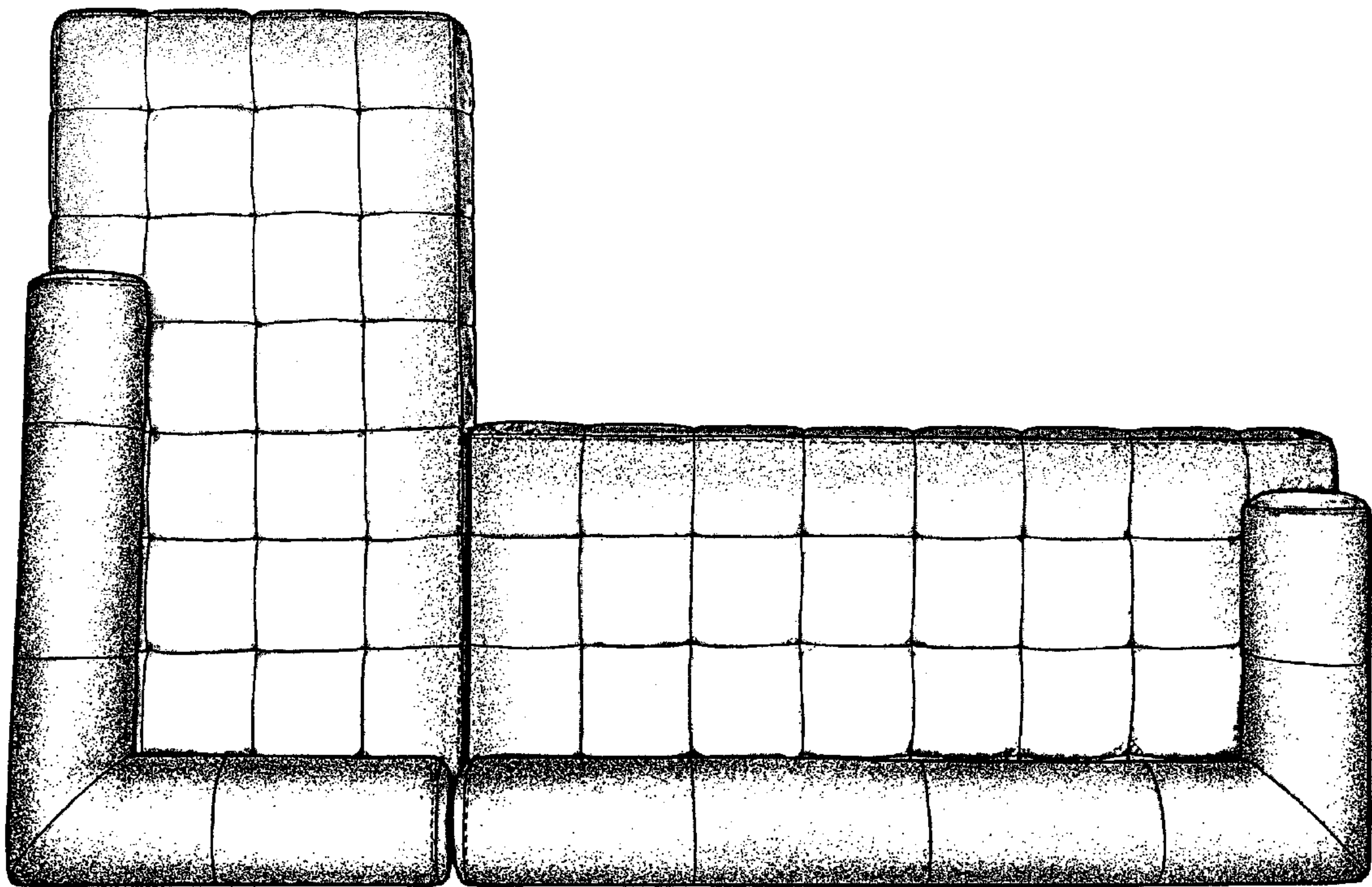

Figure 6