



US00D542486S

(12) **United States Design Patent**
Crookshanks

(10) **Patent No.:** **US D542,486 S**

(45) **Date of Patent:** **** May 8, 2007**

(54) **PORTION OF A LAUNDRY APPLIANCE**

D517,255 S * 3/2006 Kim et al. D32/5
D517,257 S * 3/2006 Kim et al. D32/6
D524,001 S * 6/2006 Carey et al. D32/6

(75) Inventor: **Kent Allen Stephen Crookshanks,**
Anderson, SC (US)

* cited by examiner

(73) Assignee: **Electrolux Home Products, Inc.,**
Cleveland, OH (US)

Primary Examiner—Louis S. Zarfaz

Assistant Examiner—Kathleen Sims

(**) Term: **14 Years**

(74) *Attorney, Agent, or Firm*—Banner & Witcoff, Ltd.

(21) Appl. No.: **29/246,284**

(57) **CLAIM**

(22) Filed: **Mar. 29, 2006**

The ornamental design for a portion of a laundry appliance,
as shown and described.

(51) **LOC (8) Cl.** **15-05**

DESCRIPTION

(52) **U.S. Cl.** **D32/6**

(58) **Field of Classification Search** D32/1,
D32/5, 6, 8, 10, 25; 34/58, 108, 523, 130–132,
34/595–597, 600, 417, 499, 534; 68/12.01,
68/12.08; 38/1 A; 312/31

FIG. 1 is a front perspective view of a portion of a laundry
appliance showing my new design;
FIG. 2 is a front view thereof;
FIG. 3 is a left side view thereof;
FIG. 4 is a right side view thereof;
FIG. 5 is a top view thereof; and,
FIG. 6 is a bottom view thereof.

See application file for complete search history.

The broken line showing of various regions, including the
unshaded areas therein, is for illustrative purposes only and
forms no part of the claimed design.

(56) **References Cited**

U.S. PATENT DOCUMENTS

D477,898 S * 7/2003 Geyer D32/6
D495,453 S * 8/2004 Baldwin et al. D32/8
D502,577 S * 3/2005 Baldwin et al. D32/6

1 Claim, 4 Drawing Sheets

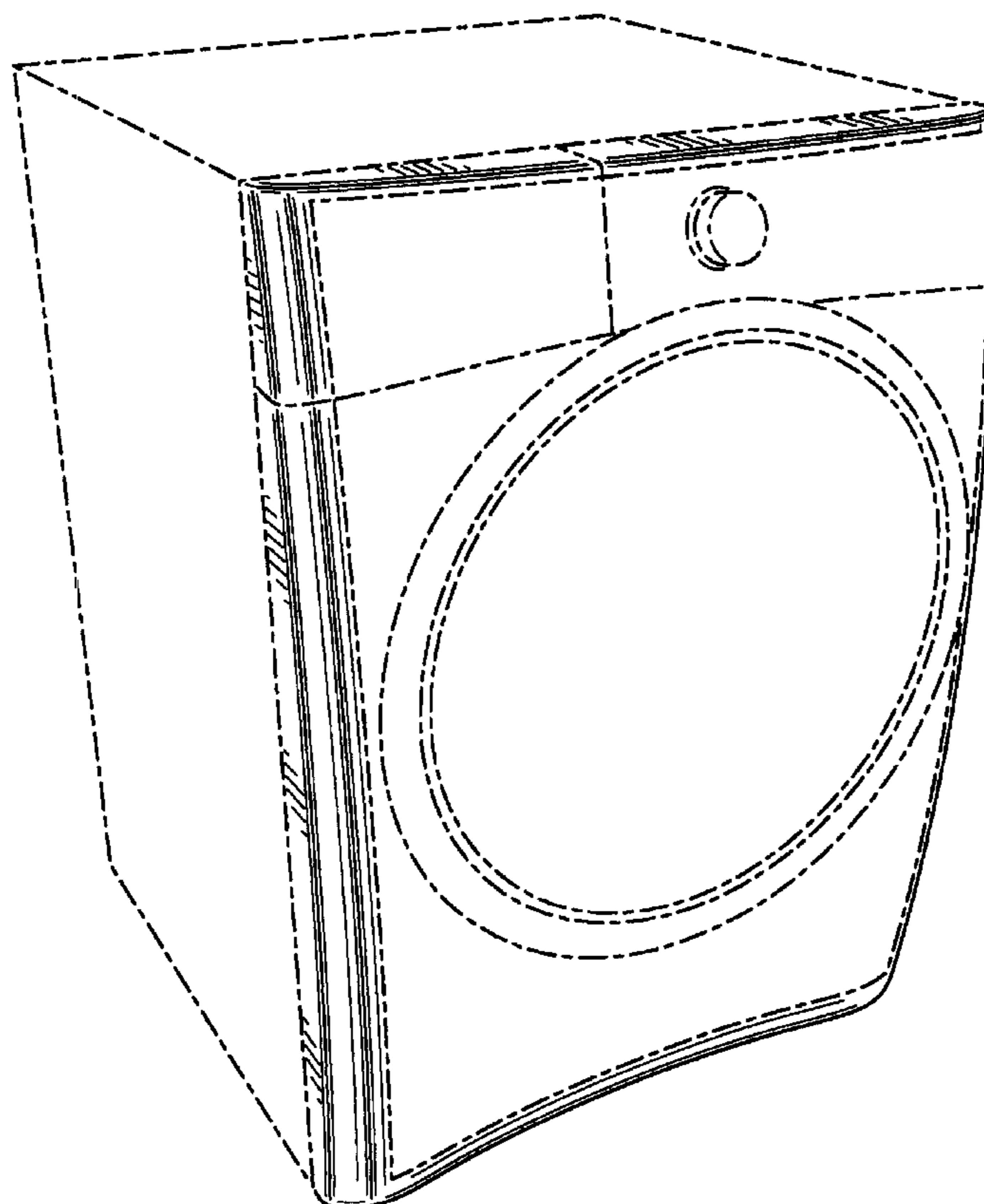

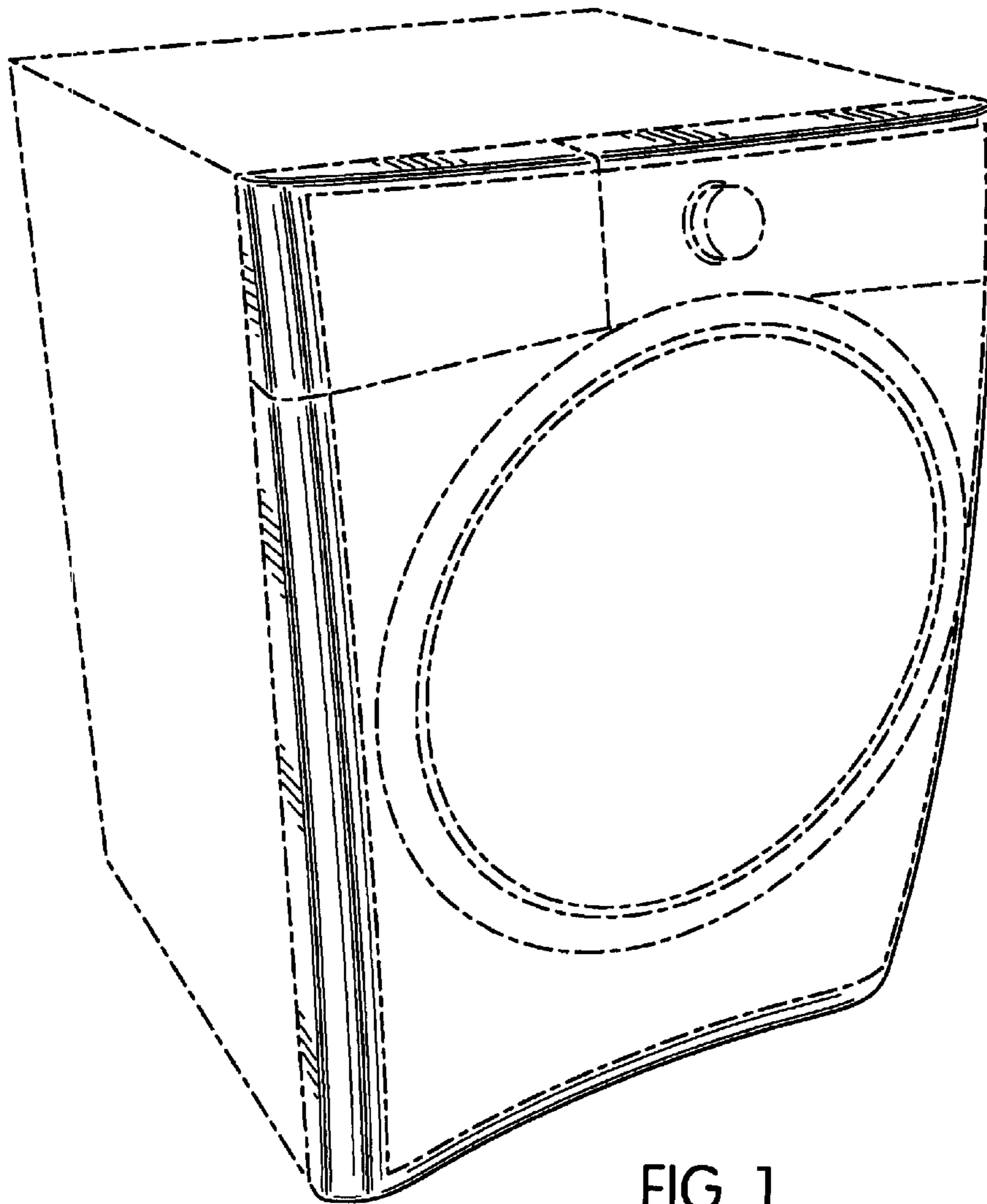

FIG. 1

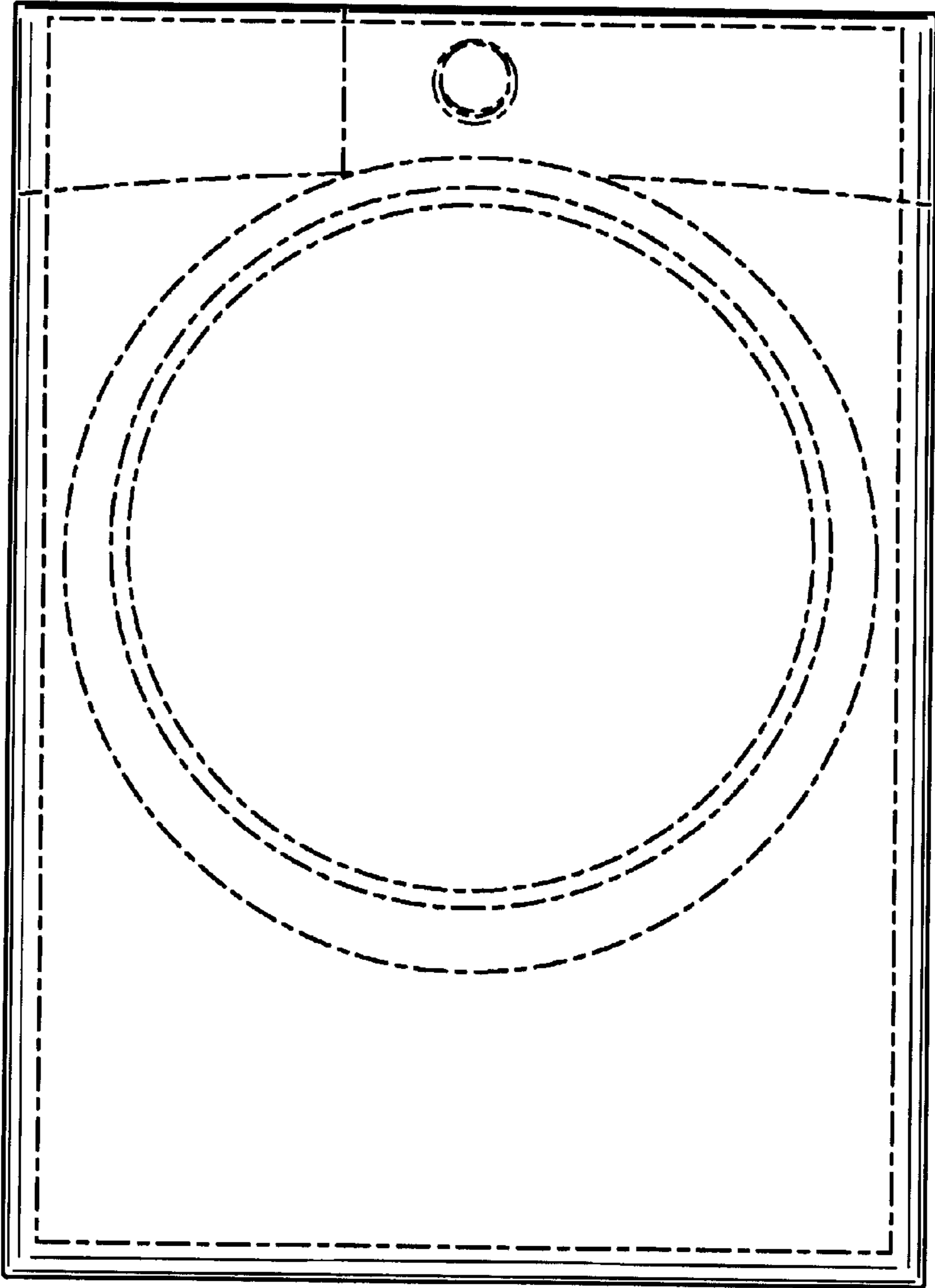

FIG. 2

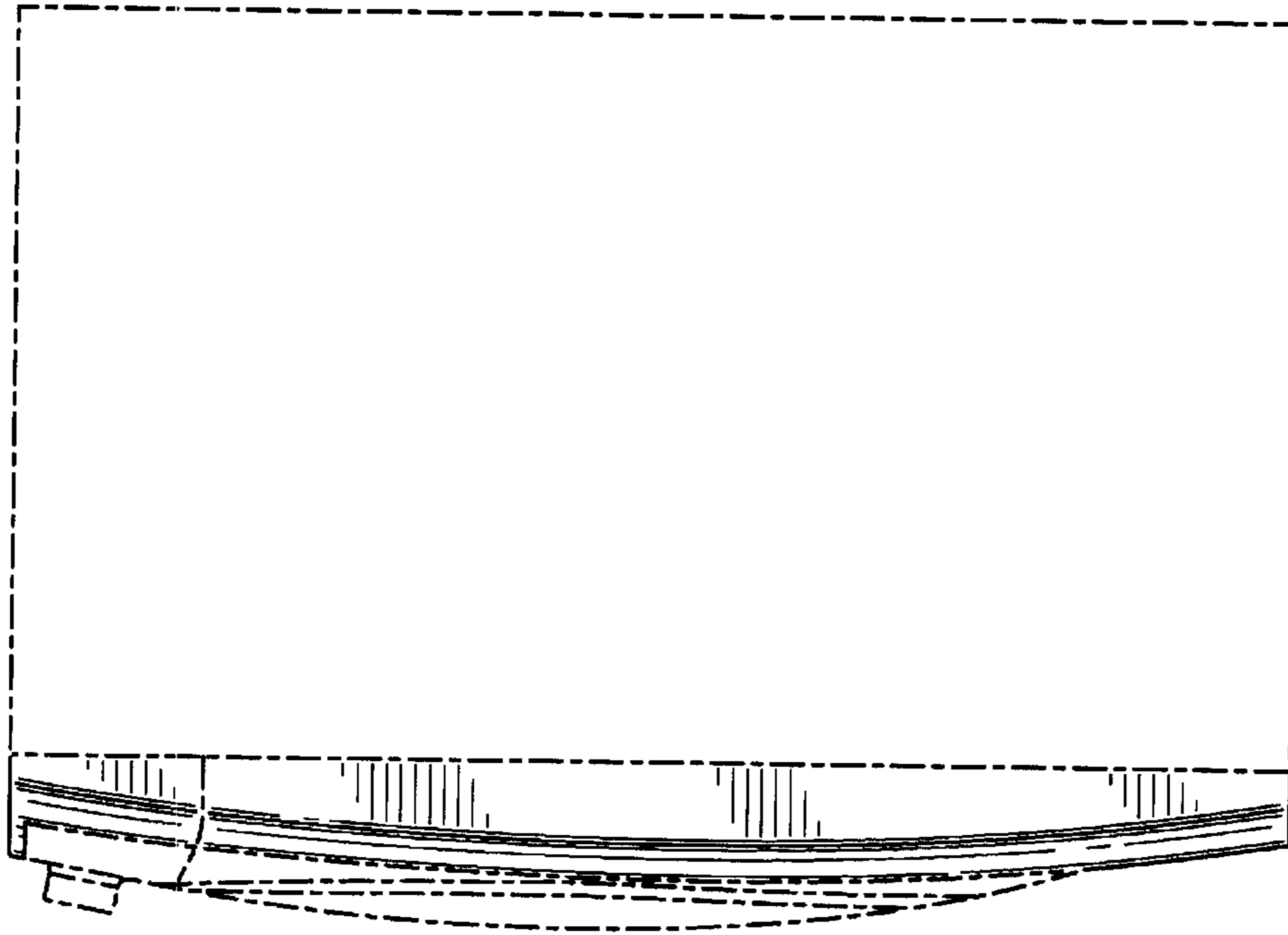

FIG. 4

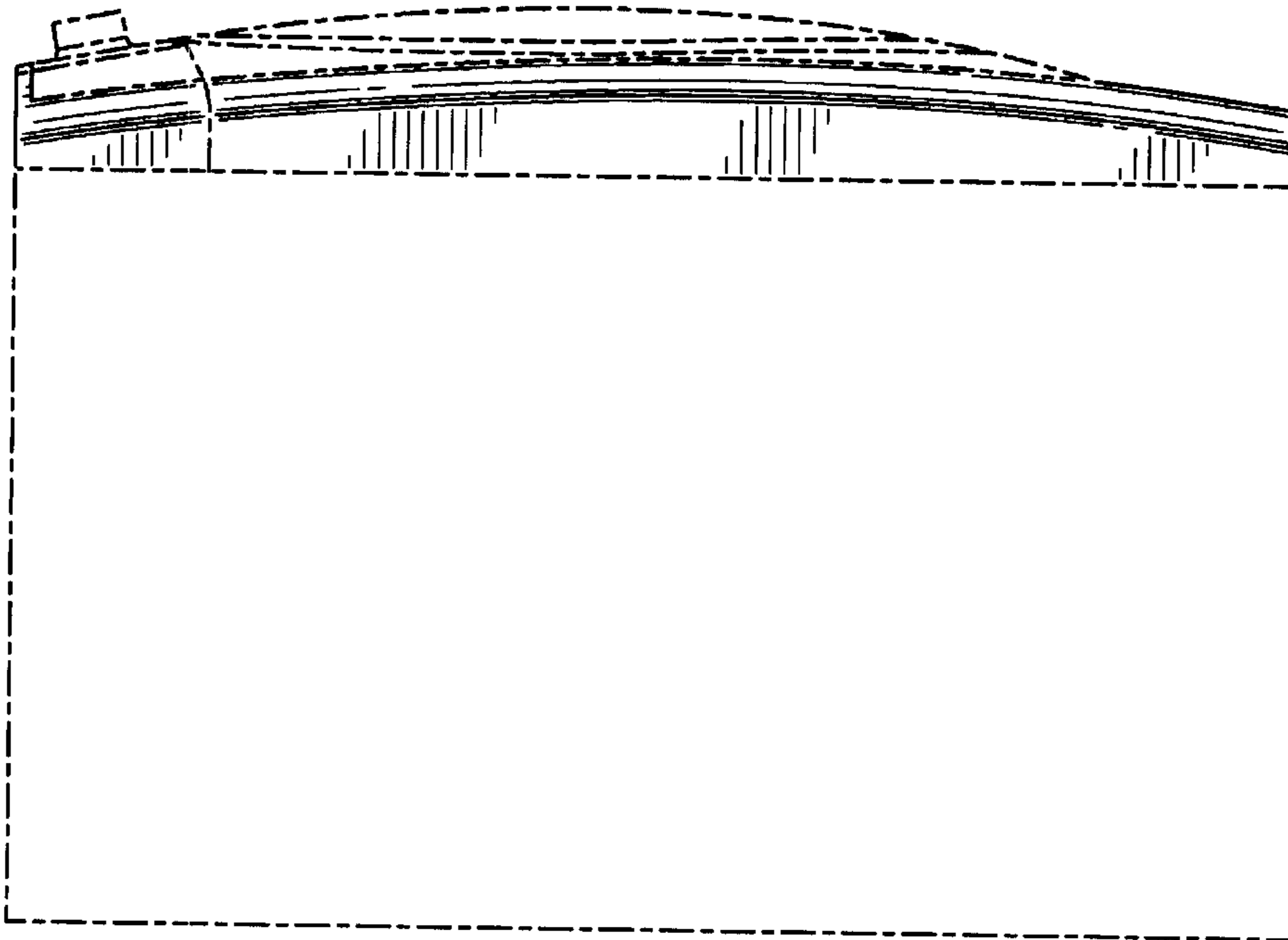

FIG. 3

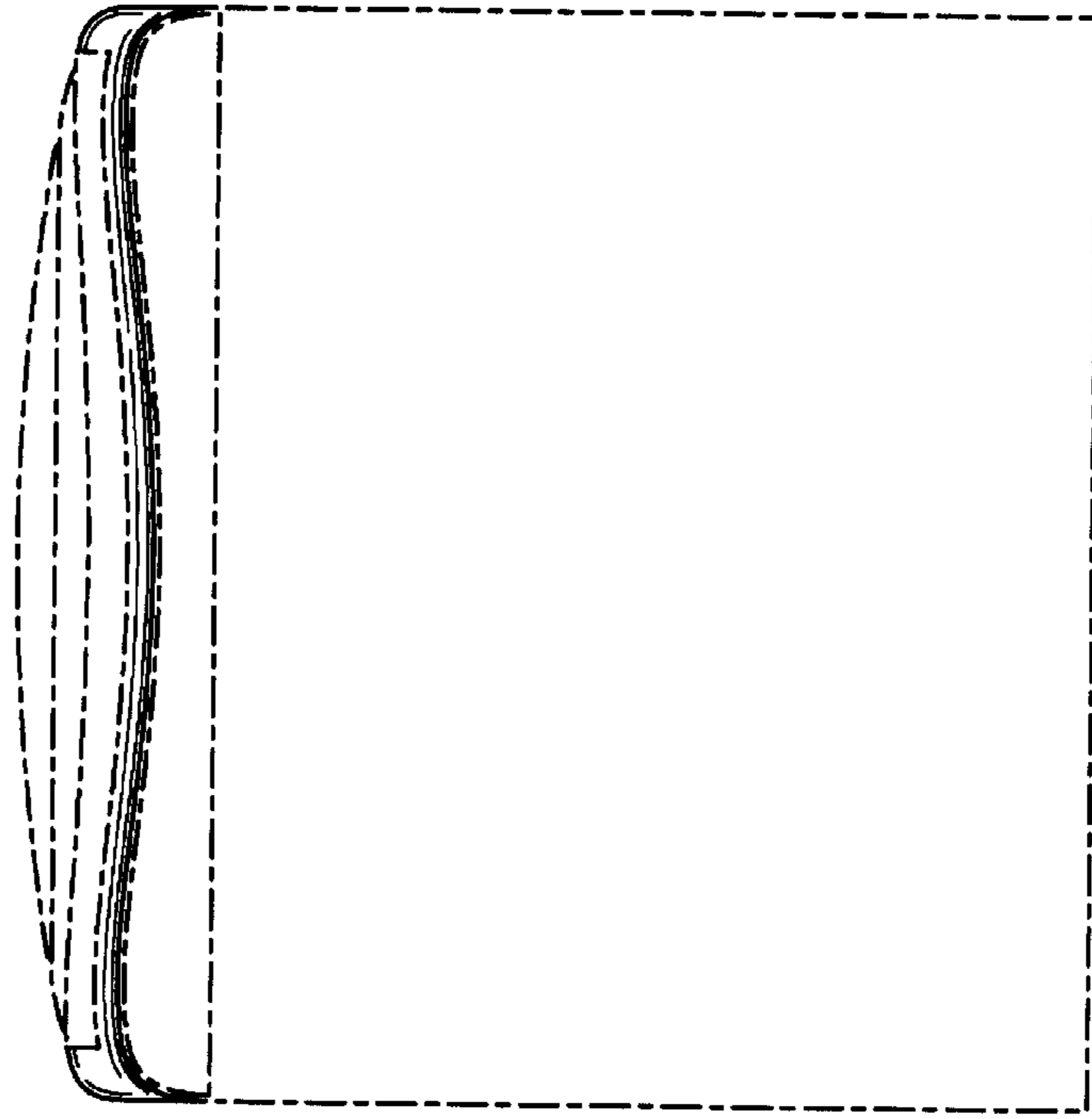

FIG. 6

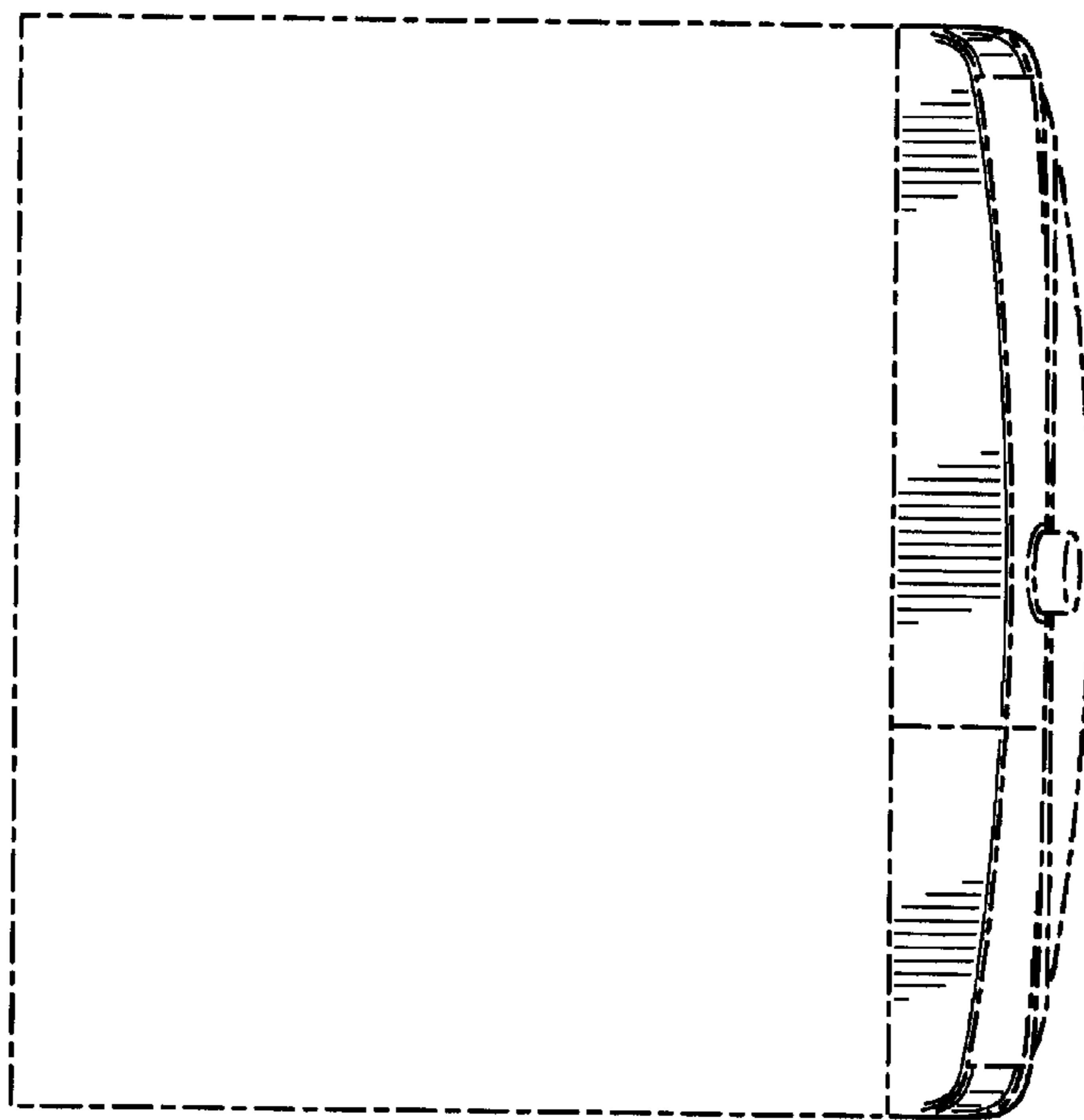

FIG. 5