

US00D542417S

(12) **United States Design Patent** (10) **Patent No.:** **US D542,417 S**
Larsen (45) **Date of Patent:** **** May 8, 2007**

(54) **SPA SKIRT**

OTHER PUBLICATIONS

(75) Inventor: **Christopher Larsen**, Vista, CA (US)
(73) Assignee: **Watkins Manufacturing Corporation**,
Vista, CA (US)
(**) Term: **14 Years**

Cal Spas, 1999 Premier Spas brochure.
Cal Spas, 2000 System Spas brochure.
Cal Spas, 2001 Premier Spas brochure.
Cal Spas, 2003 Genesis Pacifica, Fiesta Belair and Fiesta Atlantic design schematics.
Sundance Spas, Cameo, Optima, Marin, Capri, & Corum Installation, Operation & Maintenance Instructions, Jan. 1997.
Sundance Spas 1998 brochure.
Sundance Spas 2000 brochure.
Spa photographs of Watkins Manufacturing Corporation Hot Spring Line, Calssic Model for the years 1982, 1983, 1989, 1994, 1995, 1997, 1998 & 2000.
Spa photographs of Watkins Manufacturing Corporation Hot Spring Line, Grandee Model for the years 1987, 1989, 1994, 1995, 1997, 1998, 2001 & 2004.
Spa photographs of Watkins Manufacturing Corporation Hot Spring Line, Prodigy Model for the years 1985, 1987, 1990, 1994, 1997, 2003, 2001 & 2004.

(21) Appl. No.: **29/252,074**

(22) Filed: **Jan. 18, 2006**

(51) **LOC (8) Cl.** **28-03**

(52) **U.S. Cl.** **D24/204**

(58) **Field of Classification Search** D24/201,
D24/204, 205; D23/213, 277; 601/154-158;
4/541.1-541.6, 547, 578.1, 579

See application file for complete search history.

(56) **References Cited**

U.S. PATENT DOCUMENTS

D101,637 S * 10/1936 Kohler et al. D23/277
D126,676 S * 4/1941 Widman D23/277
D260,429 S * 8/1981 Myers D24/205
D267,271 S 12/1982 Kingsley et al.
D277,985 S 3/1985 Kingsley
D287,620 S 1/1987 Delepine
D295,666 S 5/1988 Griffiths
D301,374 S 5/1989 D’Innocente
D305,061 S 12/1989 Pauls et al.
D405,182 S 2/1999 Larsen
D405,185 S 2/1999 Larsen
D405,186 S 2/1999 Larsen
D431,297 S 9/2000 Larsen et al.
D436,178 S 1/2001 Larsen et al.
D445,904 S 7/2001 Larsen
D446,309 S 8/2001 Bower
D446,310 S 8/2001 Bower
D446,862 S 8/2001 Larsen et al.
6,324,707 B1 * 12/2001 Larsen et al. 4/541.1
D454,387 S * 3/2002 Bertoli D23/277
D463,028 S 9/2002 Bower
D463,569 S 9/2002 Bower
D465,576 S 11/2002 Larsen
D496,107 S 9/2004 Larsen

(Continued)

Primary Examiner—Ian Simmons
Assistant Examiner—Melanie Levy

(57) **CLAIM**

I claim the ornamental design for a spa skirt, as shown and described.

DESCRIPTION

FIG. 1 is a top perspective view of the ornamental design of a spa skirt;
FIG. 2 is a top view of the spa skirt;
FIG. 3 is a front view of the spa skirt;
FIG. 4 is a back view of the spa skirt;
FIG. 5 is a left side view of the spa skirt; and,
FIG. 6, is a right side view of the spa skirt.
The matter delineated in dashed lines forms no part of the claimed ornamental design.

1 Claim, 4 Drawing Sheets

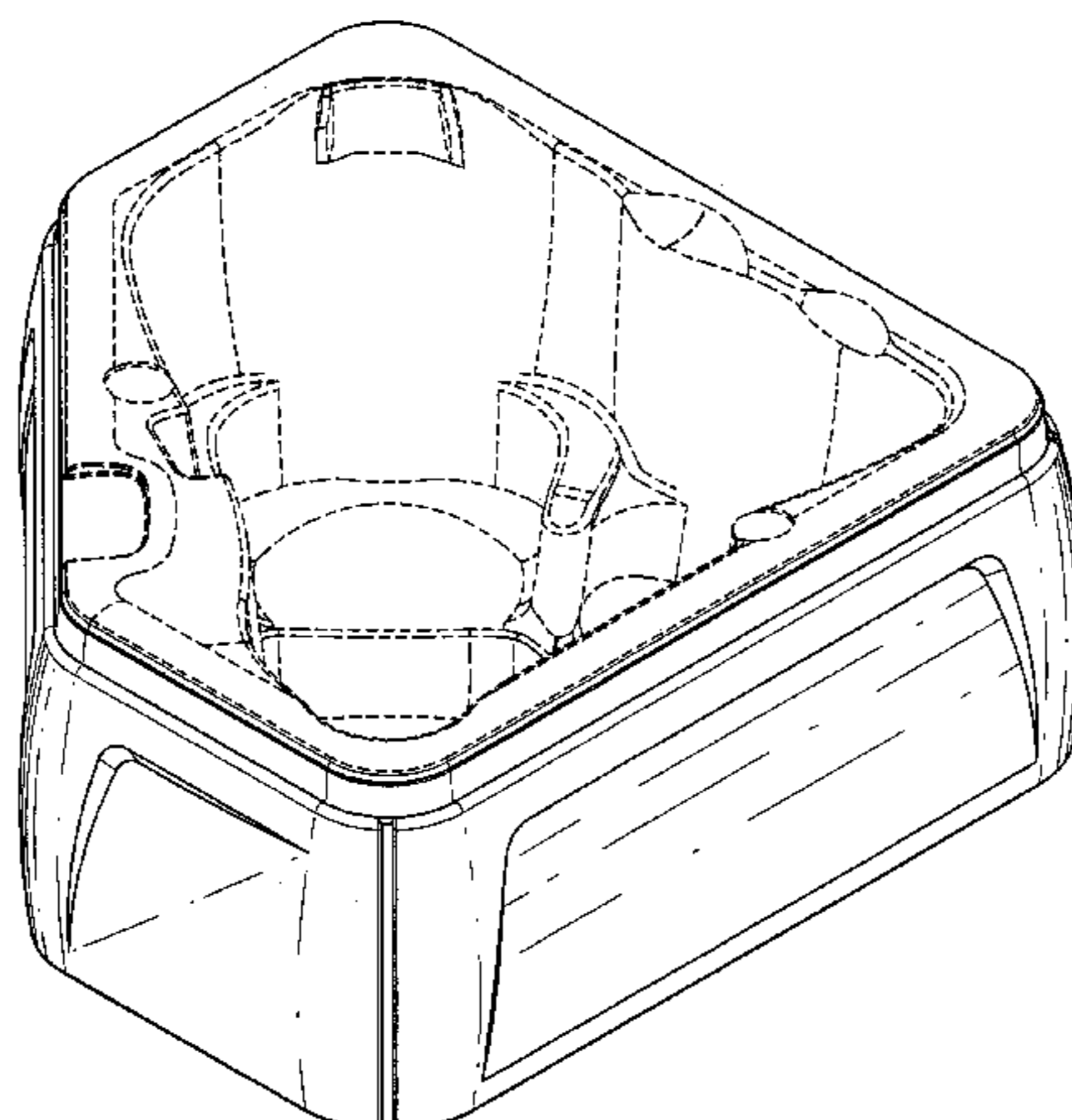

OTHER PUBLICATIONS

Spa photographs of Watkins Manufacturing Corporation Hot Spring Line, Sovereign Model for the years 1984, 1986, 1988, 1991, 1994, 1995, 1997, 2001, 2002, 2003, 2004i & 2004ii.

Spa photographs of Watkins Manufacturing Corporation Hot Spring Line, Highlife Model for the years 1989, 1992, 1994 & 1995.

Spa photographs of Watkins Manufacturing Corporation Hot Spring Line, Jetsetter Model for the years 1985, 1987, 1990, 1994, 1997, 2001, 2003 & 2004.

Spa photographs of Watkins Manufacturing Corporation Hot Spring Line, Landmark Model for the years 1995, 1997, 1998, 2000, 2001 & 2003.

Spa photograph of Watkins Manufacturing Corporation Hot Spring Line, Envoy Model for the year 2004.

Spa photograph of Watkins Manufacturing Corporation Hot Spring Line, Summit Model for the year 1985.

Spa photographs of Watkins Manufacturing Corporation Hot Spring Line, Vanguard Model for the years 2001, 2002, 2003 & 2004.

Spa photograph of Watkins Manufacturing Corporation Hot Spring Line, Vista Model for the year 2004.

Spa photographs of Watkins Manufacturing Corporation Tiger River Line, Bengal Model for the years 1992, 1997, 1998, 2001, 2002 & 2004.

Spa photographs of Watkins Manufacturing Corporation Tiger River Line, Caspian Model for the years 2003 & 2004.

Spa photographs of Watkins Manufacturing Corporation Tiger River Line, Siberian Model for the years 1992, 1995, 1996, 1997, 1998, 2000, 2001 & 2004.

Spa photographs of Watkins Manufacturing Corporation Tiger River Line, Sumatran Model for the years 1992, 1995, 1997, 1998, 2001 & 2004.

Spa photographs of Watkins Manufacturing Corporation Hot Spot Line, Round Model for the years, 1993, 1998 & 2002.

Spa photographs of Watkins Manufacturing Corporation Hot Spot Line, Square Model for the years 1995, 1998, 2001 six & 2001.

Cal Spas, 1998 Current Models Portable Spas brochure.

Cal Spas, 1998 System Spa Models.

Cal Spas, 2004 Spas –Hot Tubs –Jacuzzis from Cal Spas website, www.calspas.com/spas, designs of C51 Bel Air Spa/Hot Tub, C51 Atlantic Spa/Hot Tub, C51 Pacific Spa/Hot Tub, C32 Bel Air/Hot Tub, C32 Atlantic Spa/Hot Tub, C32 Pacifica Spa/Hot Tub, C22 Bel Air Spa/Hot Tub, C22 Atlantic Spa/Hot Tub.

Coleman Spas, 1998 Horizon Series brochure, Coleman Spas Horizon Series Delivers the Ultimate in Hydrotherapeutic Environments.

Coleman Spas, 1998 Horizon 400 Series Specifications.

Coleman Spas, 1998 The Horizons Series brochure.

Coleman Spas, 1998 The Horizon Series brochure, Simply the best hot tub available.

Coleman Spas, 1998 Horizon Series brochure, Coleman Spas Horizon Series Delivers the Ultimate in Hydrotherapeutic Environments.

Sundance Spas, 2000 brochure.

Sunrise Spas, [www.sunrisespas.com /products/valueseries](http://www.sunrisespas.com/products/valueseries) website pages of Sunrise Spas Zodiac VS, Poseidon VS, Zodiac SSD and Poseidon SS designs, 2004.

Copy of Spa photograph Watkins Manufacturing Corporation Hot Spot (Caldera Highland) Line, Sorrento (Cumberland) Model, 2002.

Copy of Spa photograph Watkins Manufacturing Corporation Hot Spot (Caldera Highland) Line, Mallorca (Olympia) Model, 2000.

Copy of Spa photograph Watkins Manufacturing Corporation Hot Spot (Caldera Highland) Line, Tobago Model, 2003.

Copy of Spa photograph Watkins Manufacturing Corporation Hot Spot (Caldera Highland) Line, Trinidad Model, 2003.

Cal Spas, 1998 System Spa Models brochure.

Copy of Spa photograph Watkins manufacturing Corporation Solana Line, Solana TX Model, 2000.

Copy of Spa photograph Watkins Manufacturing Caldera Line, Aspire, Cumberland, Elation, Geneva, Hawaiian, Kauai, Martinique, Niagara, Olympia, Palomar and Tahitian Models, 2004.

* cited by examiner

FIG. 1

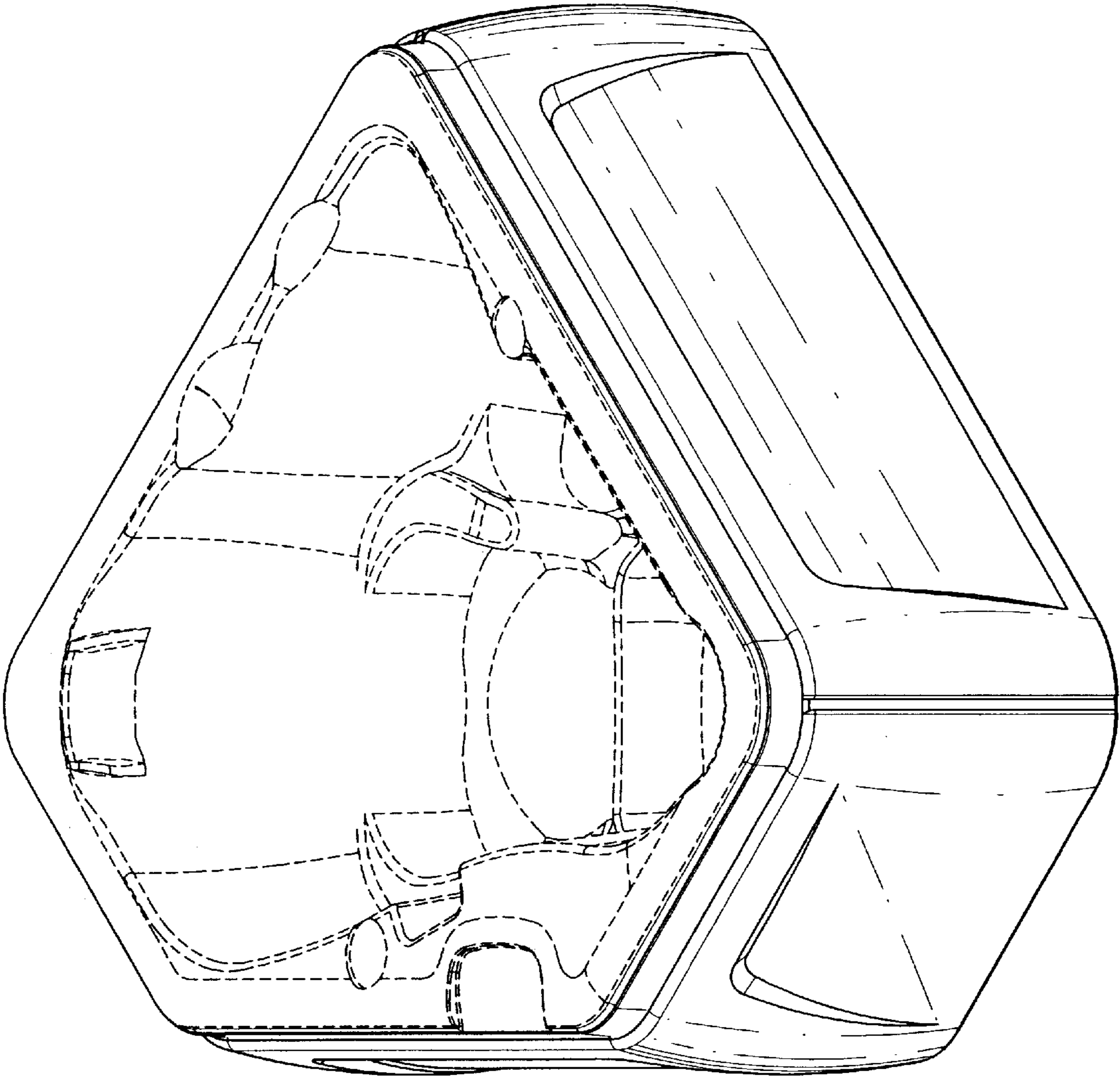

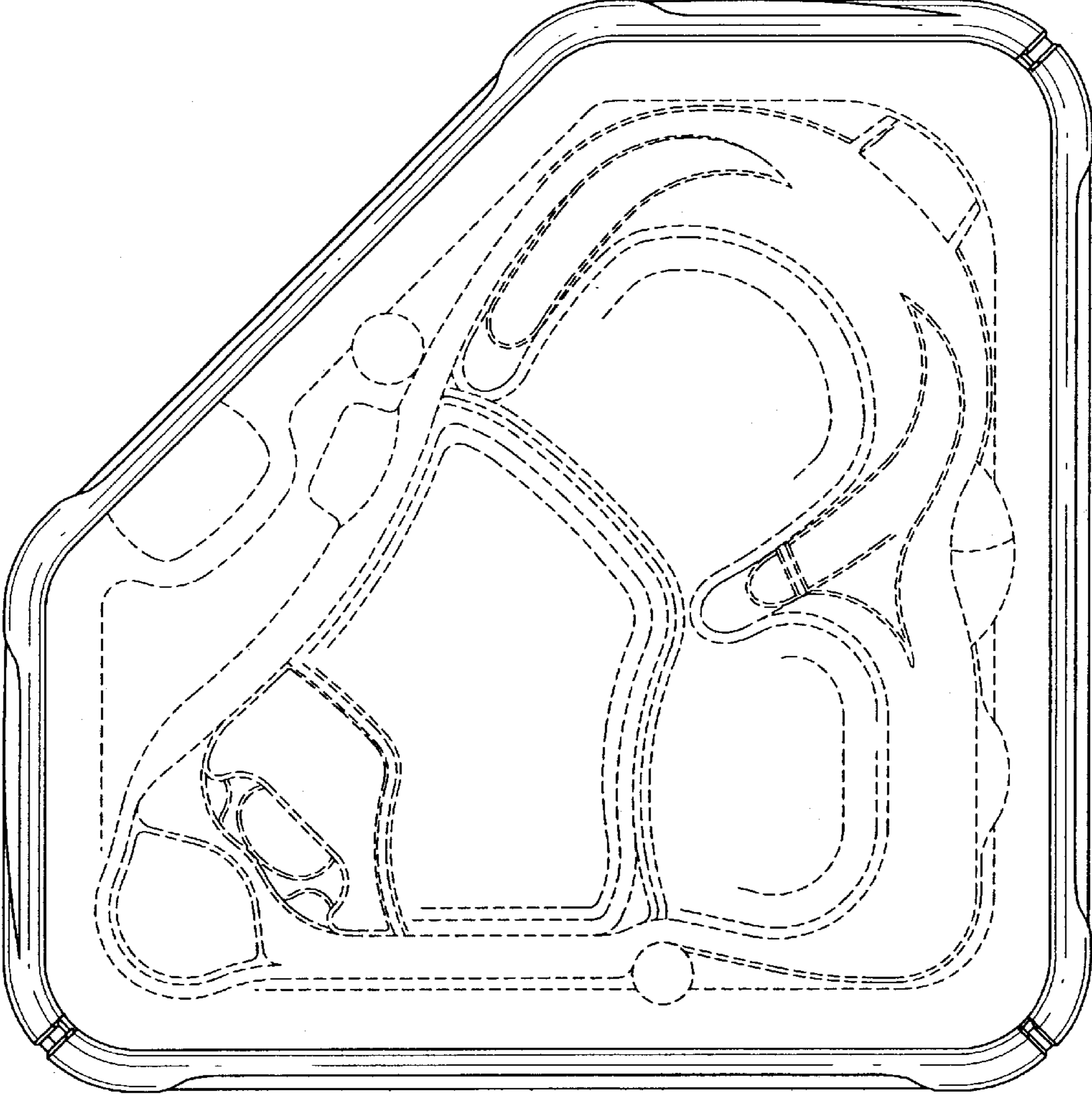

FIG. 2

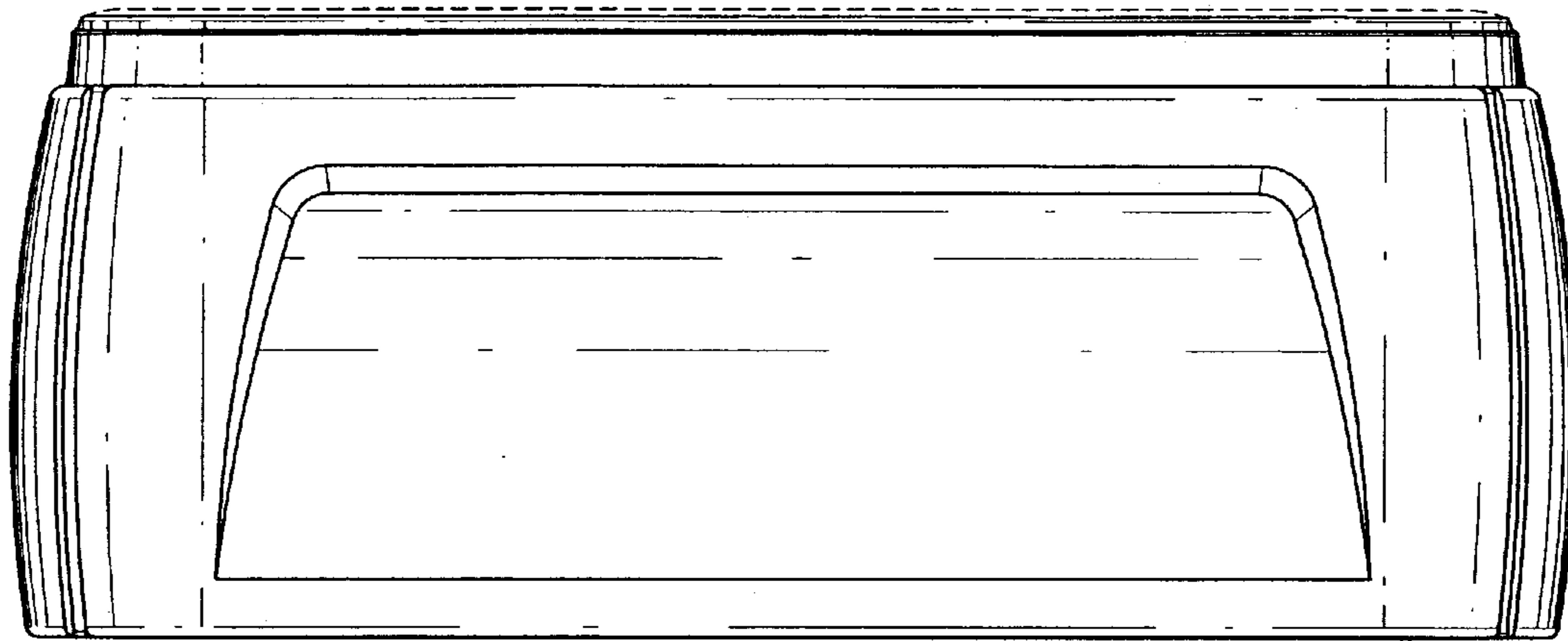

FIG. 3

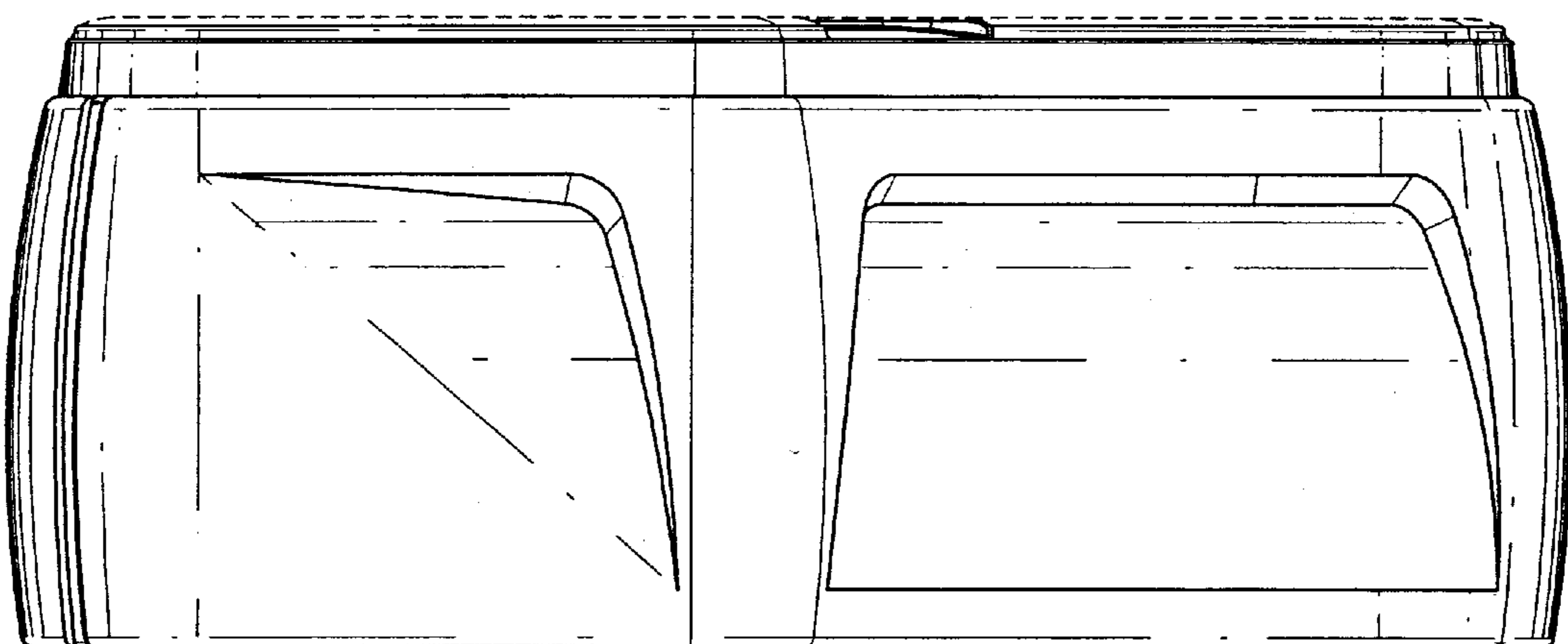

FIG. 4

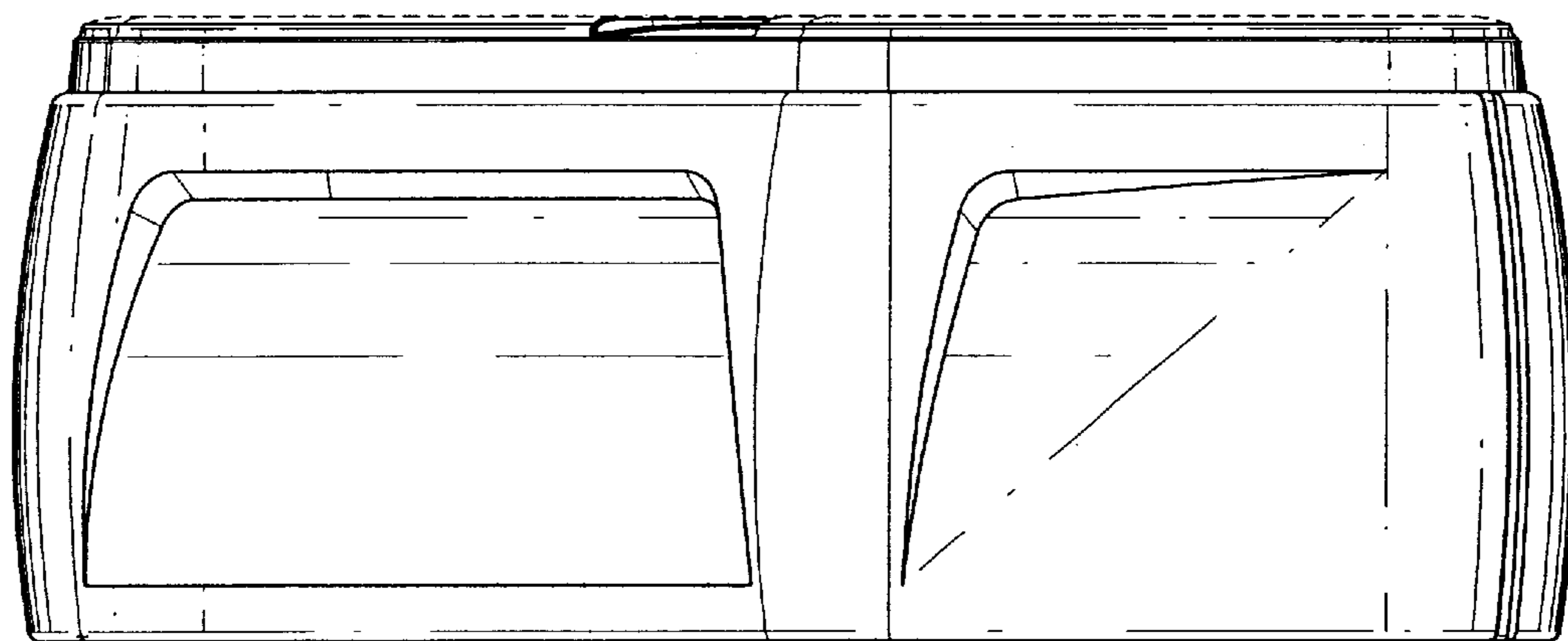

FIG. 5

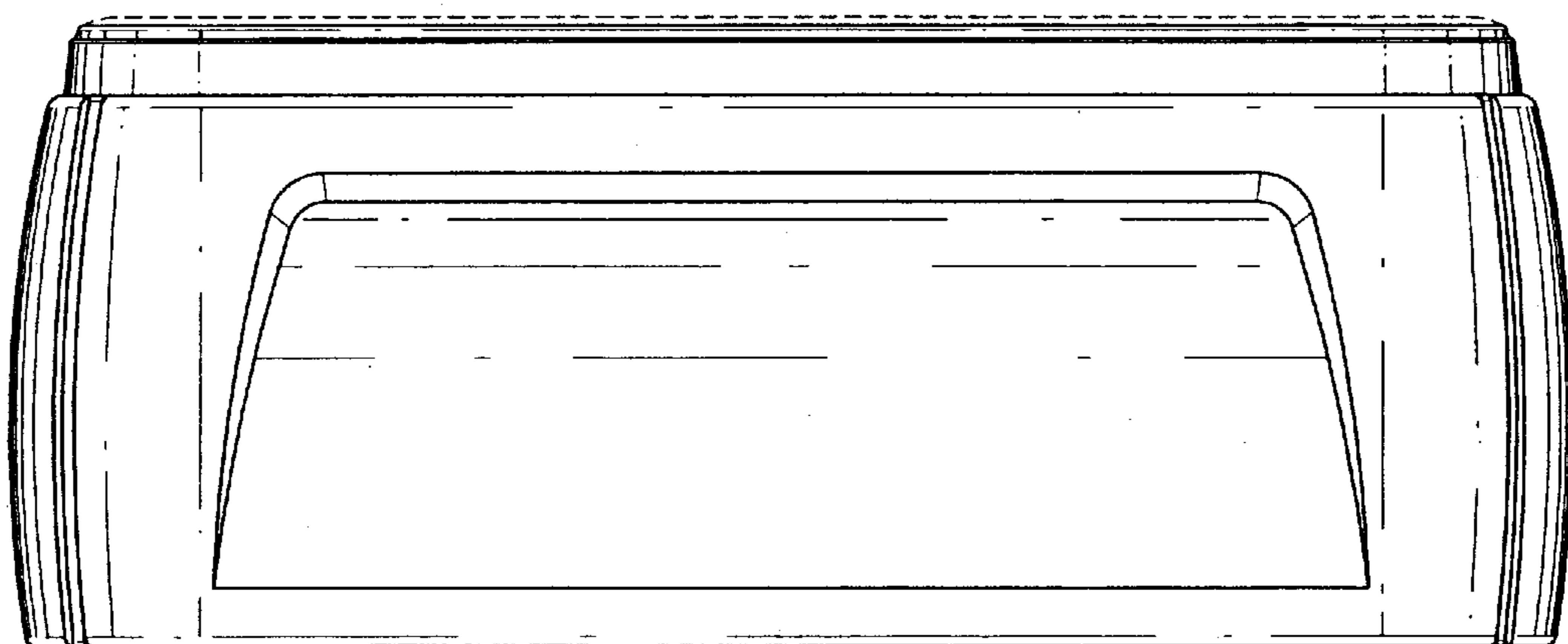

FIG. 6