



US00D542349S

(12) **United States Design Patent**
Anand

(10) **Patent No.:** **US D542,349 S**

(45) **Date of Patent:** **** *May 8, 2007**

- (54) **TOP PRESS RETRACTABLE PEN**
- (75) Inventor: **Devendra S. Anand**, Mumbai (IN)
- (73) Assignee: **Anand International** (IN)
- (*) Notice: This patent is subject to a terminal disclaimer.
- (**) Term: **14 Years**
- (21) Appl. No.: **29/228,212**
- (22) Filed: **Apr. 21, 2005**
- (51) **LOC (8) Cl.** **19-06**
- (52) **U.S. Cl.** **D19/50**
- (58) **Field of Classification Search** D19/36,
D19/37, 41-51, 54-57; 24/11 R, 11 F, 11 P;
401/52, 99, 100, 104, 105, 106, 107, 108,
401/109, 192, 195, 243-247
See application file for complete search history.

D498,260 S	*	11/2004	Burden et al.	D19/51
D508,717 S		8/2005	Anand	D19/50
D509,852 S		9/2005	Anand	D19/50
D509,853 S		9/2005	Anand	D19/51
D512,457 S		12/2005	Anand	D19/48
D512,459 S		12/2005	Anand	D19/51

* cited by examiner

Primary Examiner—Elizabeth A. Albert

(74) *Attorney, Agent, or Firm*—St. Onge Steward Johnston & Reens LLC

(57) **CLAIM**

The ornamental design for top press retractable pen, as shown and described.

DESCRIPTION

FIG. 1 is a perspective view of a top press retractable pen in accordance with the new design;
 FIG. 2 is a top view of top press retractable pen of FIG. 1;
 FIG. 3 is a bottom view of top press retractable pen of FIG. 1;
 FIG. 4 is a side view of top press retractable pen of FIG. 1;
 FIG. 5 is a front view of top press retractable pen of FIG. 1;
 FIG. 6 is a second side view of top press retractable pen of FIG. 1; and,
 FIG. 7 is a rear view of top press retractable pen of FIG. 1.
 The stippling shown on the grip portion of the pen represents a texture on the surface of the grip.

- (56) **References Cited**
U.S. PATENT DOCUMENTS
- D388,825 S * 1/1998 Kouda D19/49
- D435,065 S * 12/2000 Nagel D19/50
- D478,932 S * 8/2003 Moon D19/51
- D494,218 S 8/2004 Anand D19/51
- D495,001 S 8/2004 Anand D19/51
- D496,401 S 9/2004 Anand D19/51

1 Claim, 6 Drawing Sheets

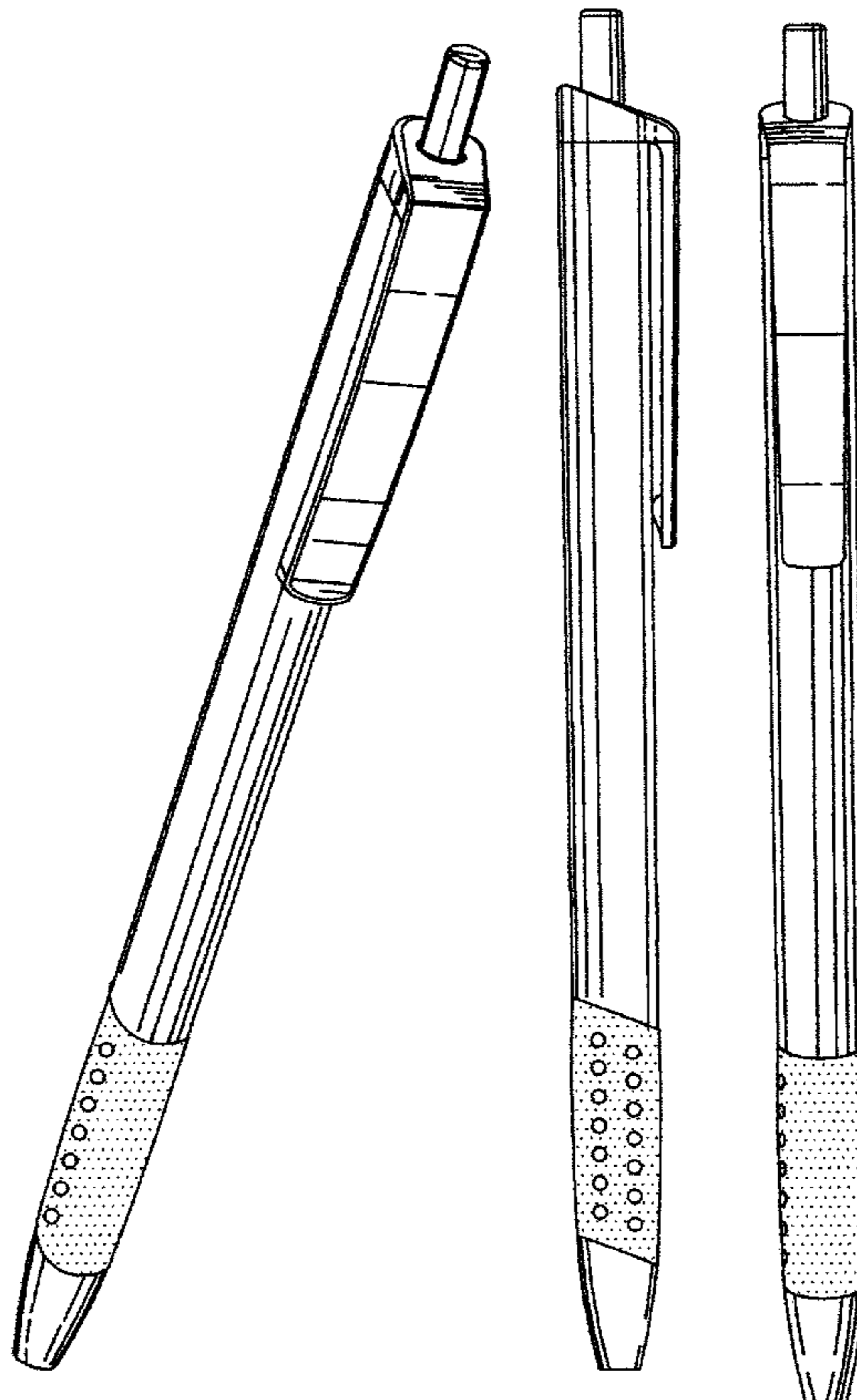

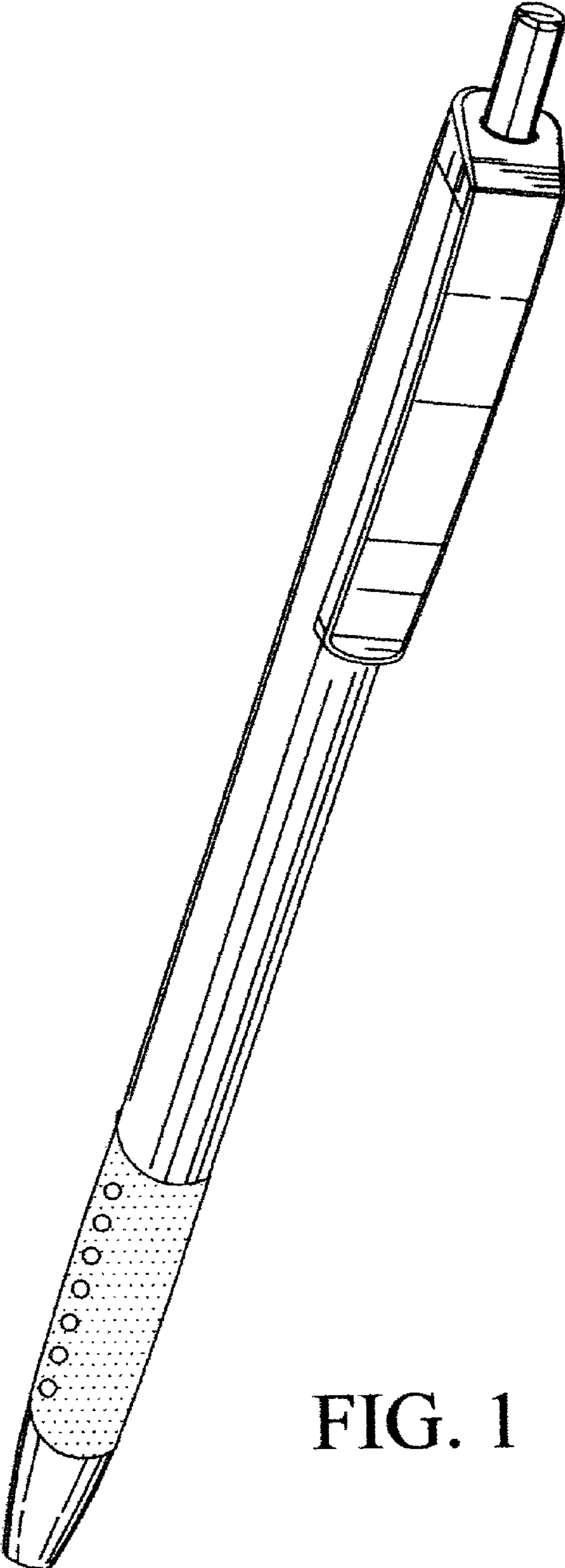

FIG. 1

FIG. 2

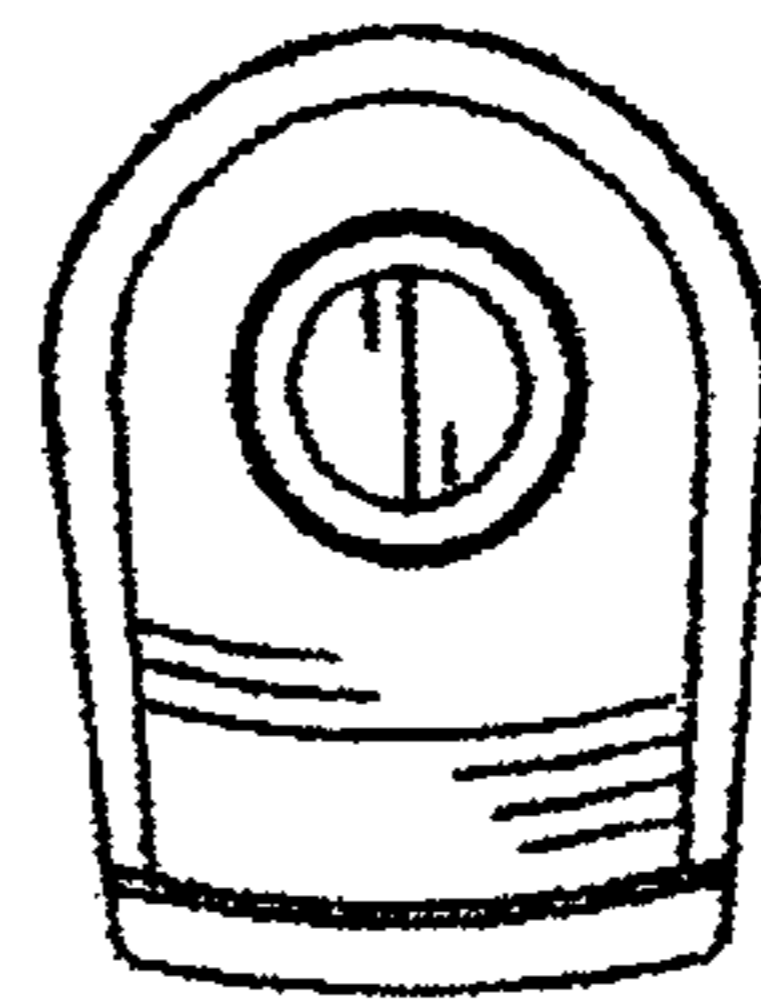

FIG. 3

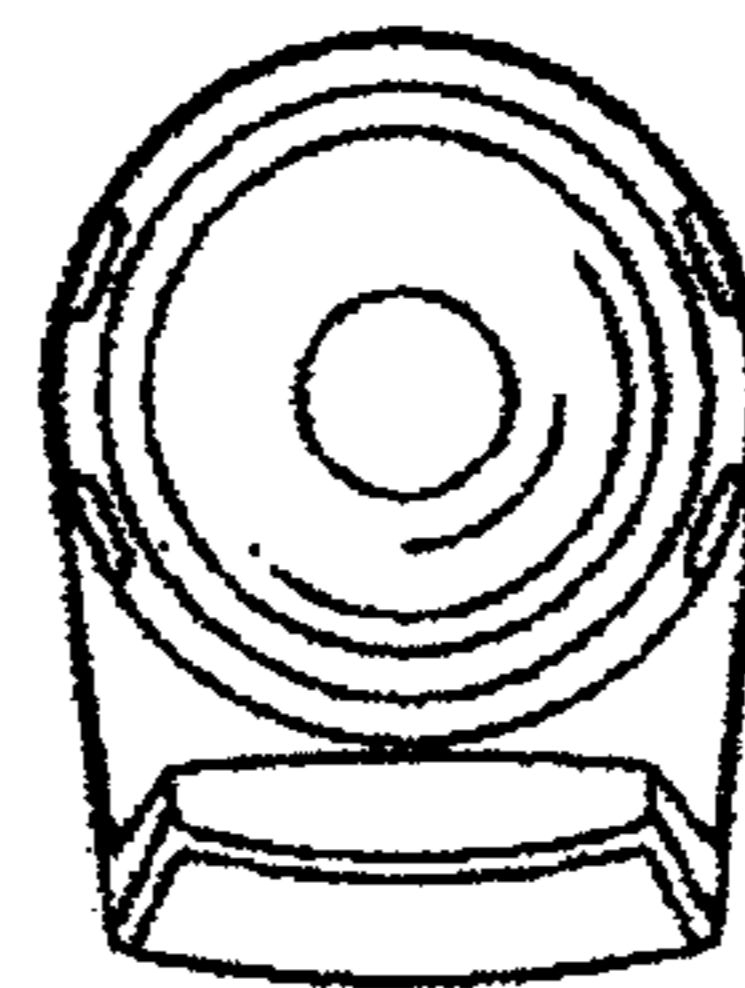

FIG. 4

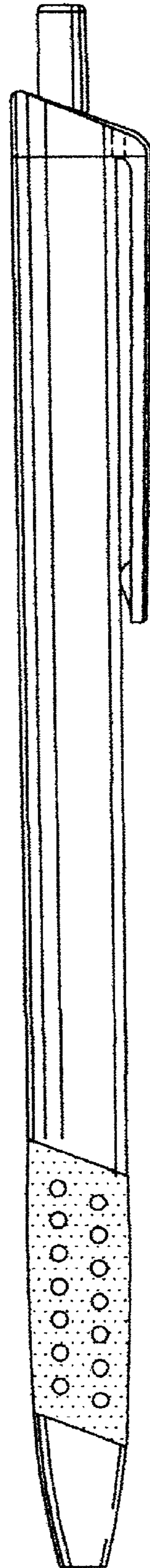

FIG. 5

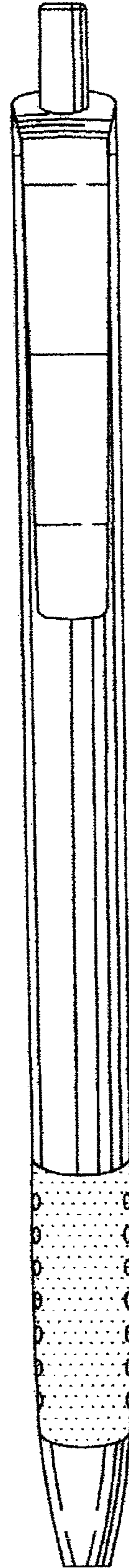

FIG. 6

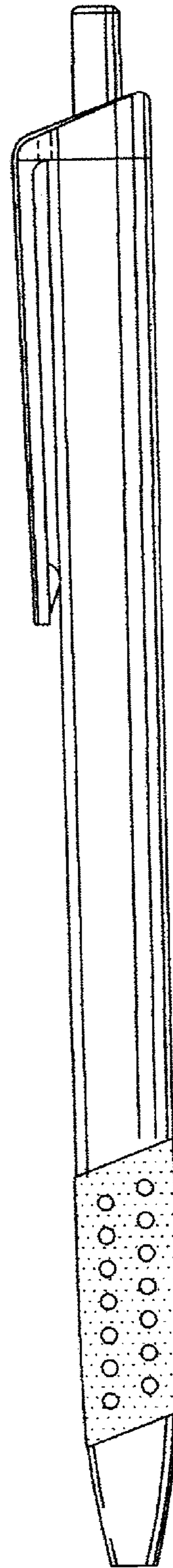

FIG. 7

