

US00D542287S

(12) **United States Design Patent**  
**Chung et al.**

(10) **Patent No.:** **US D542,287 S**

(45) **Date of Patent:** **\*\* May 8, 2007**

(54) **COVER FOR CELLULAR PHONE  
PROVIDED WITH SPEAKER MODULE**

2003/0103624 A1 \* 6/2003 Hu ..... 379/455  
2006/0226039 A1 \* 10/2006 Goradesky ..... 206/320

(75) Inventors: **Sung-Mo Chung**, Seoul (KR);  
**Jong-Seong Lee**, Seoul (KR);  
**Chang-Hwan Hwang**, Goyang-si (KR)

FOREIGN PATENT DOCUMENTS

WO DM/061671 \* 10/2002

(73) Assignee: **Samsung Electronics Co., Ltd.** (KR)

OTHER PUBLICATIONS

(\*\*) Term: **14 Years**

“Holster for iPod”, 1 p including photo, [online],  
<URL: <http://www.cellphoneshop.net/holsterforipod.html>>,  
site visited Oct. 25, 2006.\*

(21) Appl. No.: **29/221,580**

\* cited by examiner

(22) Filed: **Jan. 17, 2005**

*Primary Examiner*—Ian Simmons

*Assistant Examiner*—Carla Jobe Wright

(30) **Foreign Application Priority Data**

(74) *Attorney, Agent, or Firm*—Cantor Colburn LLP

Nov. 22, 2004 (KR) ..... 30-2004-0035661

(57) **CLAIM**

(51) **LOC (8) Cl.** ..... **14-03**

We claim, the ornamental design for a cover for cellular phone provided with speaker module, as shown and described.

(52) **U.S. Cl.** ..... **D14/252; D14/215**

(58) **Field of Classification Search** ..... D14/172,  
D14/204, 214–216, 221, 240, 250–253; D3/201,  
D3/218; 379/433.01, 446, 455; 455/575.1,  
455/575.8; 206/320, 701; 248/309.1, 311.2  
See application file for complete search history.

**DESCRIPTION**

(56) **References Cited**

U.S. PATENT DOCUMENTS

D320,991 S \* 10/1991 Nagai et al. .... D14/251  
D324,389 S \* 3/1992 Kamata ..... D14/215  
D346,275 S \* 4/1994 Hayasaka et al. .... D3/218  
D348,355 S \* 7/1994 Scheid et al. .... D3/218  
D462,514 S \* 9/2002 Rivera et al. .... D3/228  
D482,345 S \* 11/2003 Homewood et al. .... D14/214  
D497,713 S \* 11/2004 Lodato et al. .... D3/218  
D529,887 S \* 10/2006 Chung et al. .... D14/138  
D530,713 S \* 10/2006 Richter ..... D14/253  
2002/0197965 A1 \* 12/2002 Peng ..... 455/90

FIG. 1 is a top and front perspective view of a cover for cellular phone provided with speaker module, showing our new design;

FIG. 2 is a front elevational view thereof;

FIG. 3 is a rear elevational view thereof;

FIG. 4 is a left side elevational view thereof;

FIG. 5 is a right side elevational view thereof;

FIG. 6 is a top elevational view thereof;

FIG. 7 is a bottom elevational view thereof; and,

FIG. 8 is a front perspective view thereof.

The broken line showing of an exemplary cell phone in FIG. 8 is included for illustrative purposes only and forms no part of the claimed design.

**1 Claim, 5 Drawing Sheets**

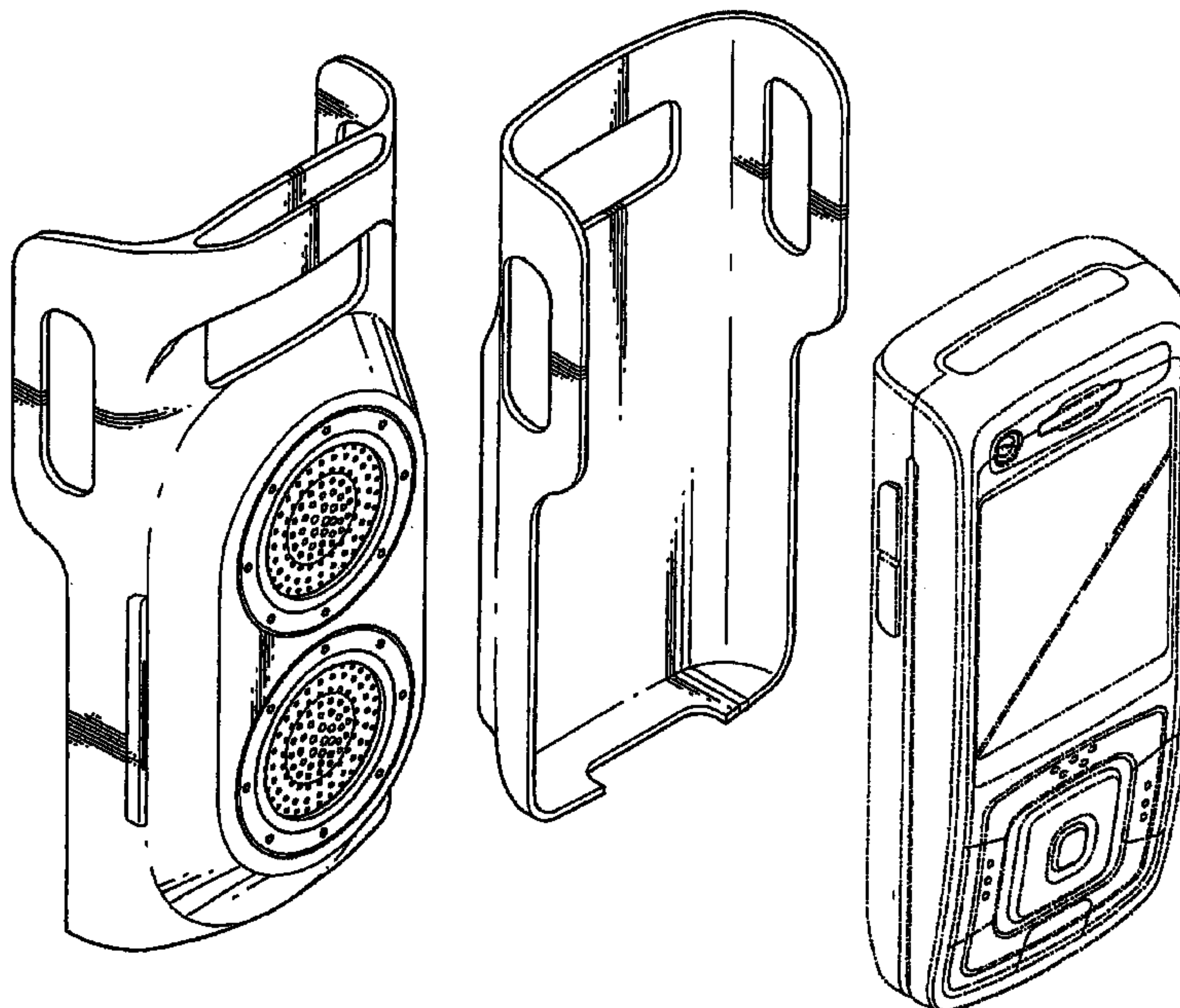

FIG. 1

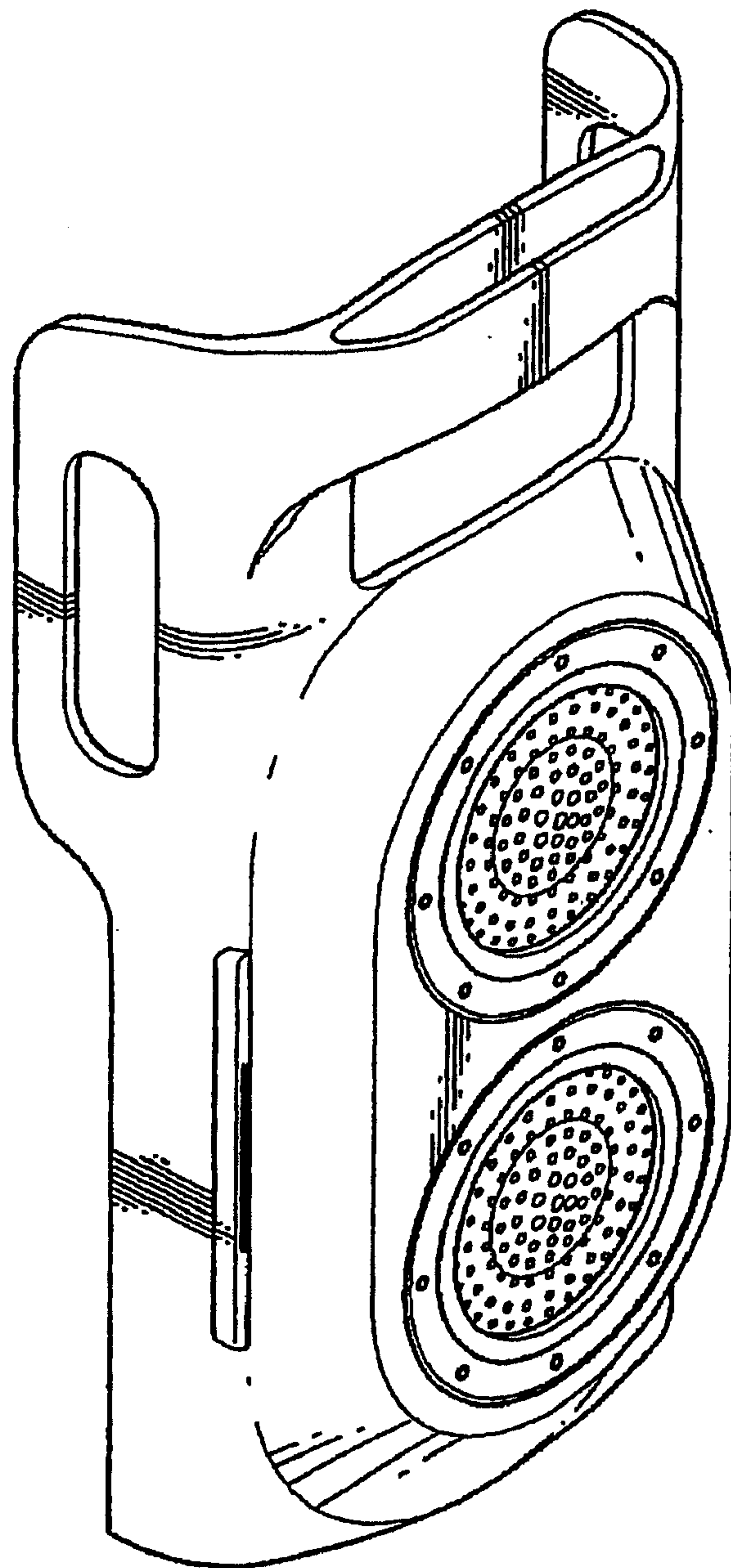

FIG. 2

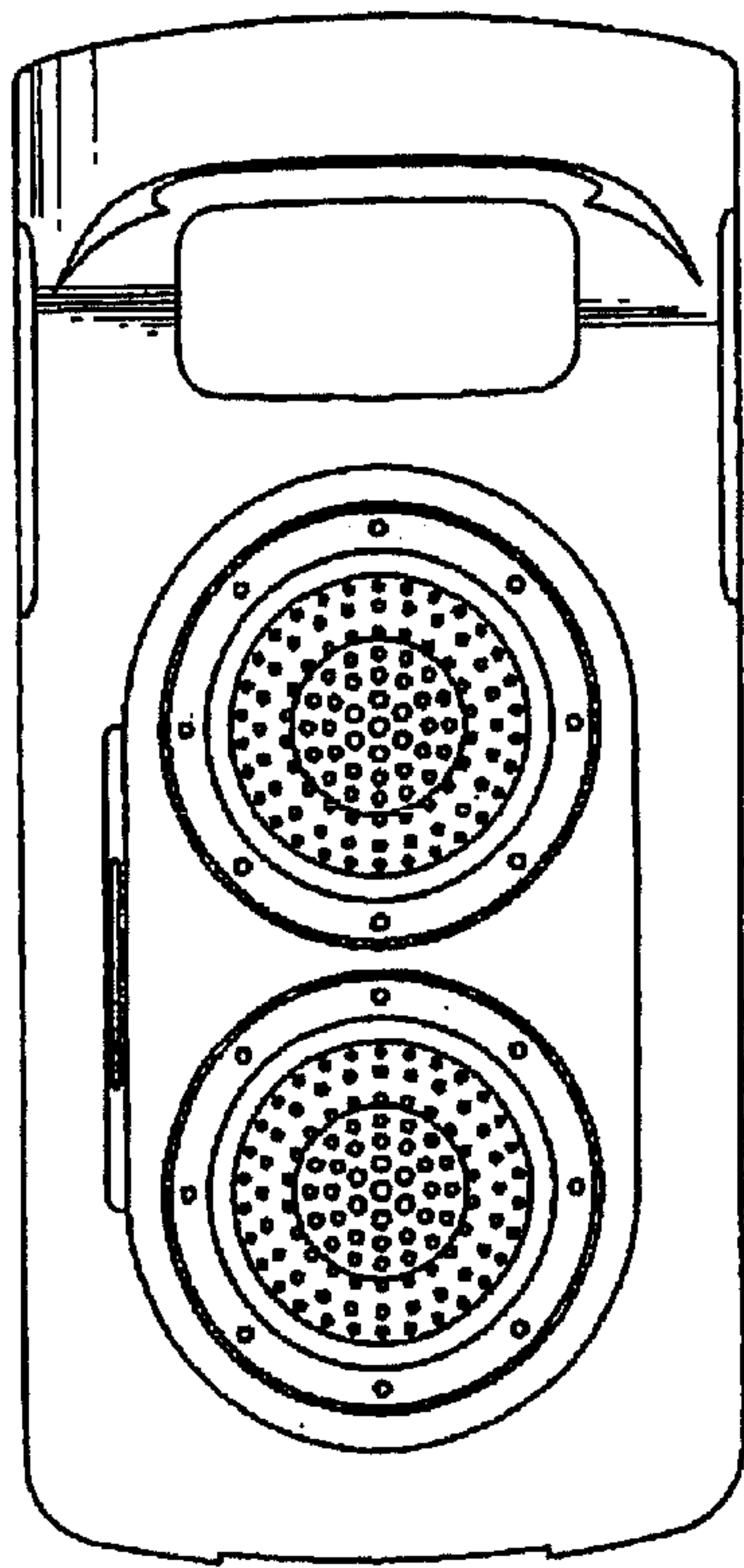

FIG. 3

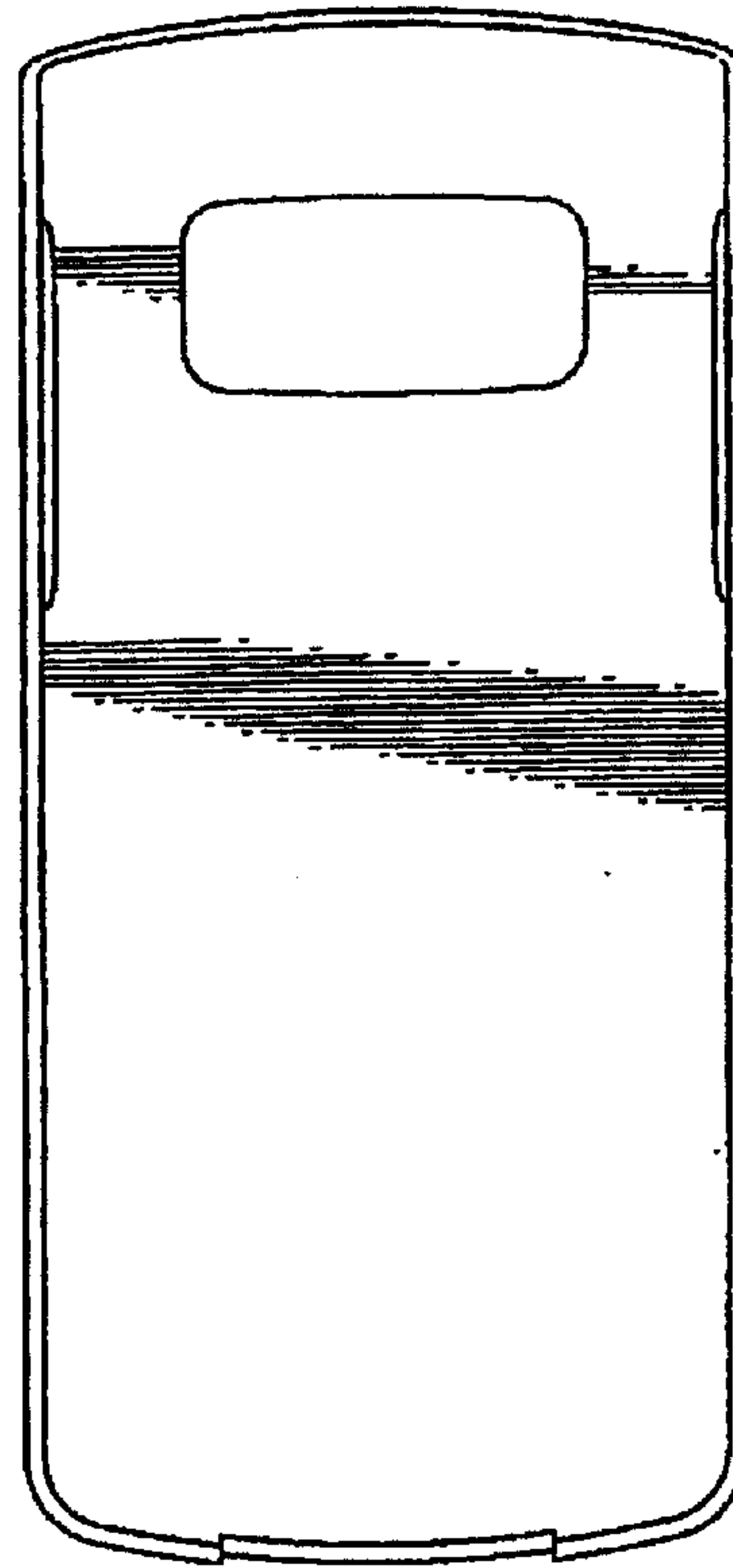

FIG. 4

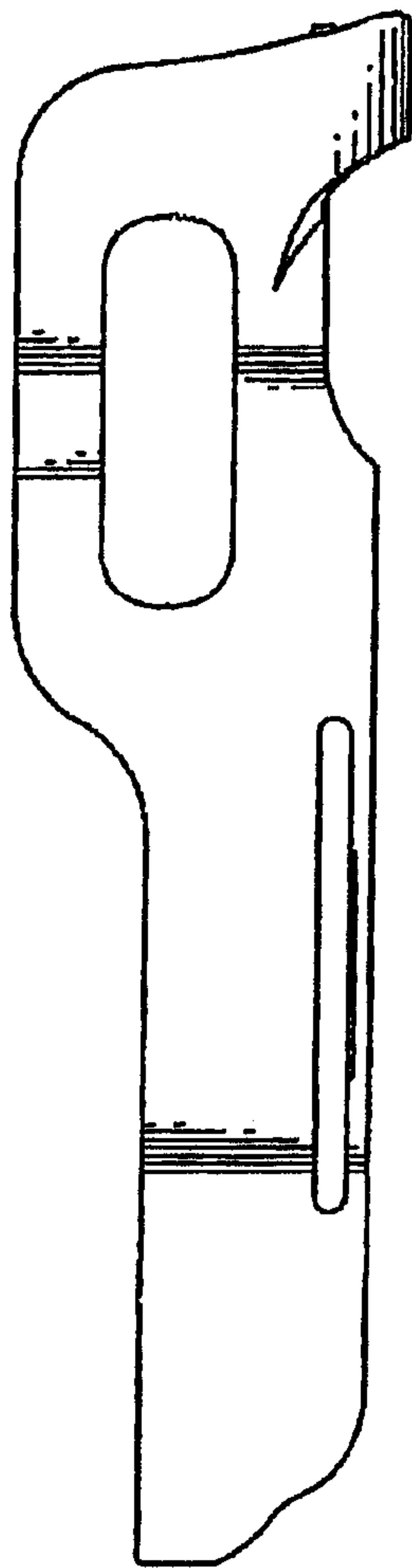

FIG. 5

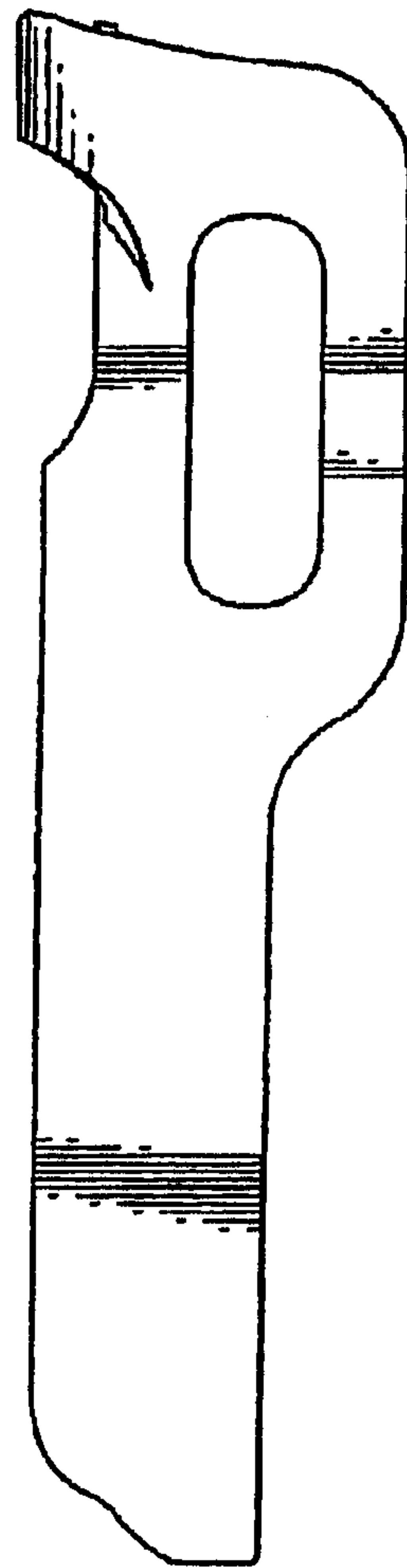

FIG.6

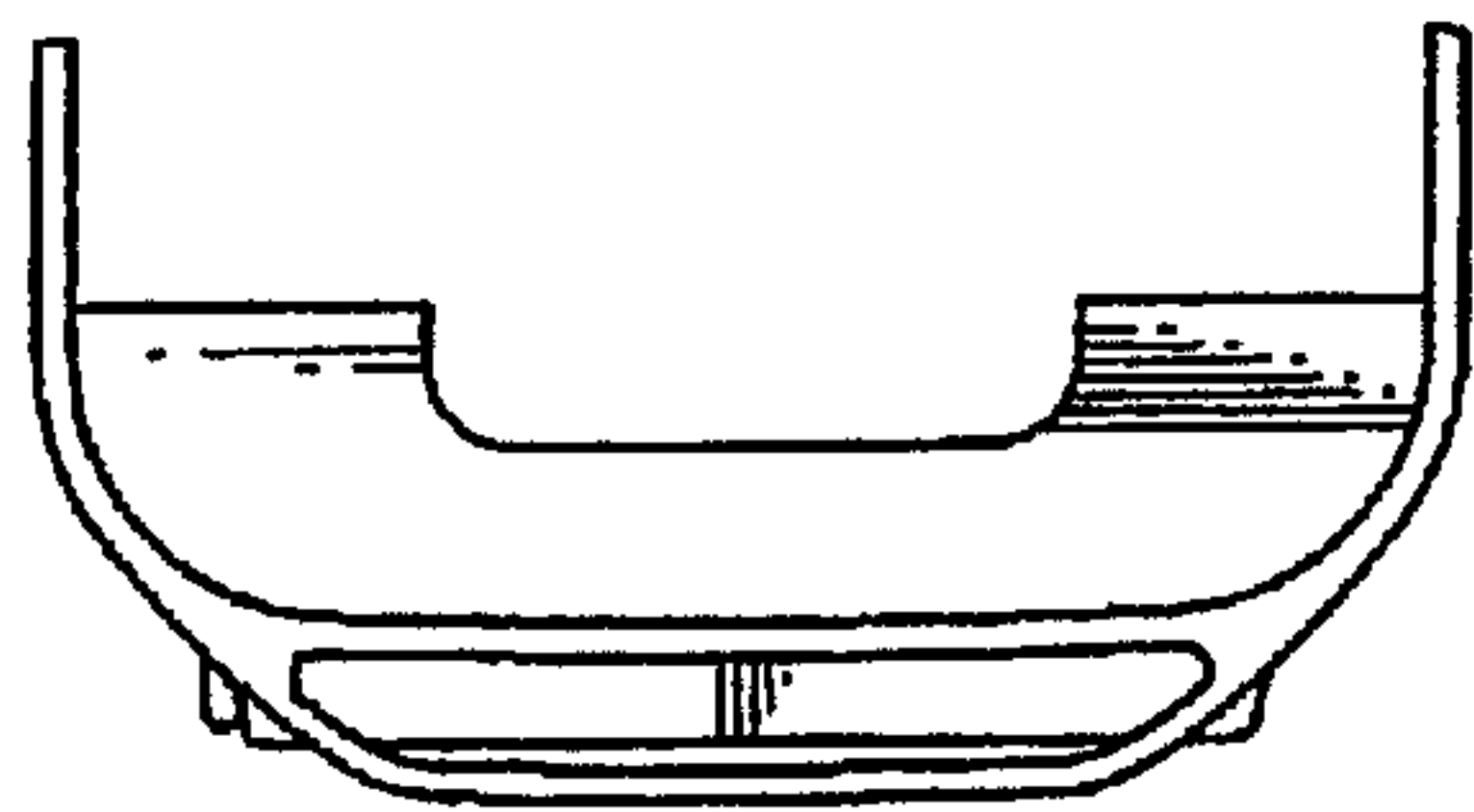

FIG.7

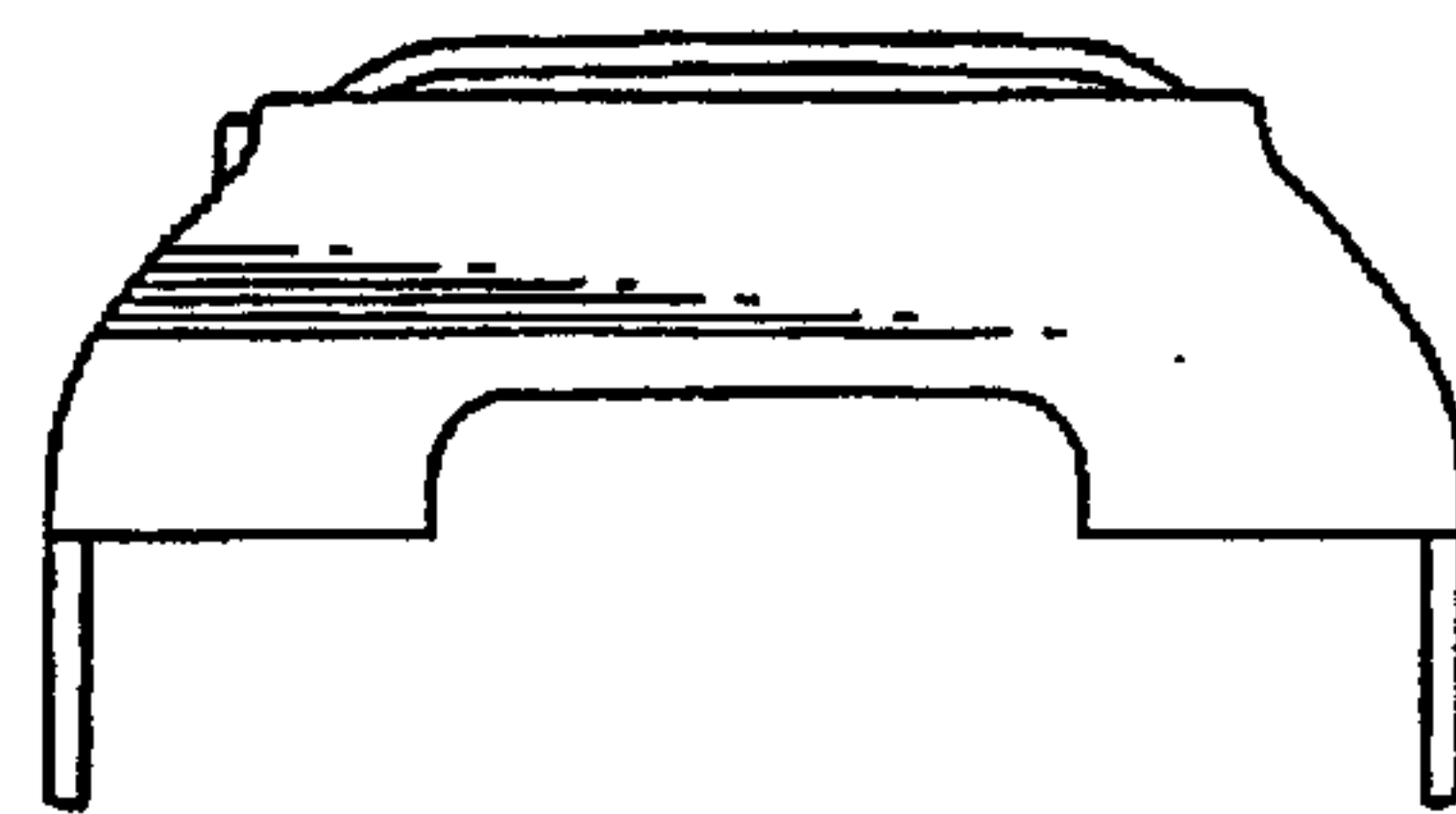



FIG. 8

