



US00D542228S

(12) **United States Design Patent**
Castro

(10) **Patent No.:** **US D542,228 S**

(45) **Date of Patent:** **** May 8, 2007**

(54) **REMOTE ELECTRICAL DISPLAY MODULE**

(75) Inventor: **Daniel E. Castro**, Cincinnati, OH (US)

(73) Assignee: **Briggs and Stratton Corporation**,
Wauwatosa, WI (US)

(**) Term: **14 Years**

(21) Appl. No.: **29/222,073**

(22) Filed: **Jan. 25, 2005**

(51) **LOC (8) Cl.** **13-03**

(52) **U.S. Cl.** **D13/162**

(58) **Field of Classification Search** D13/137,
D13/137.3, 158, 162, 165; D10/40; 73/117.3;
123/352; 174/48, 50, 58; 200/42.01, 38 R,
200/38 FB, 38 D, 38 DA, 51 R, 52 R; 340/438,
340/457.4

See application file for complete search history.

(56) **References Cited**

U.S. PATENT DOCUMENTS

- 3,997,742 A * 12/1976 Marquis 200/38 FB
- 4,297,546 A * 10/1981 Koch 200/38 R
- 4,798,082 A 1/1989 Fujikawa et al.
- D315,893 S * 4/1991 Cheng D13/165
- 5,353,762 A 10/1994 Dykstra et al.
- D352,472 S * 11/1994 Chen D10/40
- D389,073 S * 1/1998 Schmidt et al. D10/40
- D431,027 S * 9/2000 Armstrong D13/162
- D436,082 S * 1/2001 Jilani D13/158

6,542,074 B1 4/2003 Tharman et al.
D520,451 S * 5/2006 Stekelenburg D13/137.3

* cited by examiner

Primary Examiner—Selina Sikder

(74) *Attorney, Agent, or Firm*—Michael Best & Friedrich
LLP

(57) **CLAIM**

We claim the ornamental design for a remote electrical
display module, as shown and described.

DESCRIPTION

FIG. 1 is a perspective view of a remote electrical display
module according to the invention;

FIG. 2 is a rear view of the remote electrical display module
of FIG. 1;

FIG. 3 is a front view of the remote electrical display module
of FIG. 1;

FIG. 4 is a left side view of the remote electrical display
module of FIG. 1;

FIG. 5 is a right side view of the remote electrical display
module of FIG. 1;

FIG. 6 is a bottom view of the remote electrical display
module of FIG. 1; and,

FIG. 7 is a top view of the remote electrical display module
of FIG. 1.

The broken line showing of the environment is for illustra-
tive purposes only and forms no part of the claimed design.

1 Claim, 7 Drawing Sheets

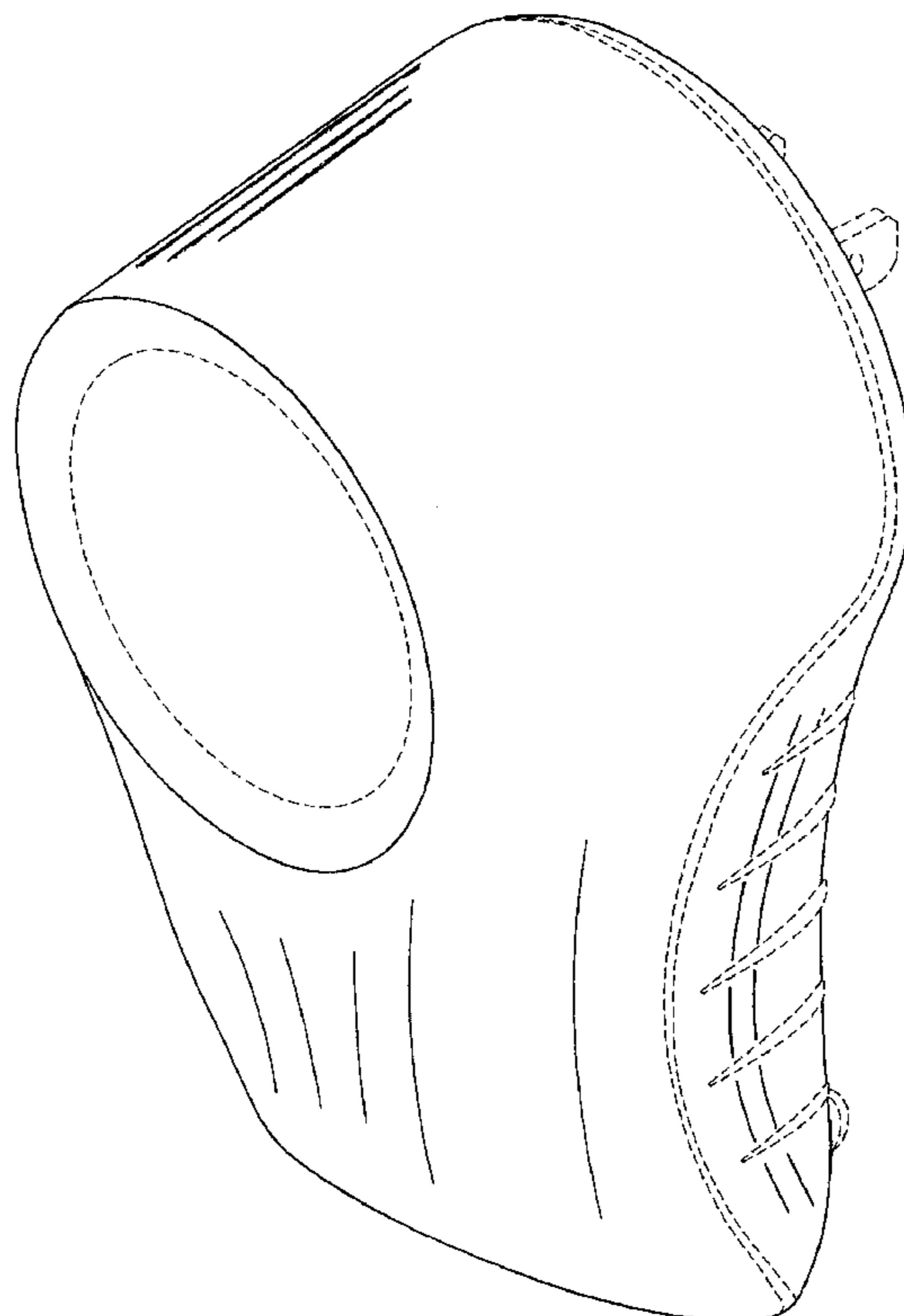

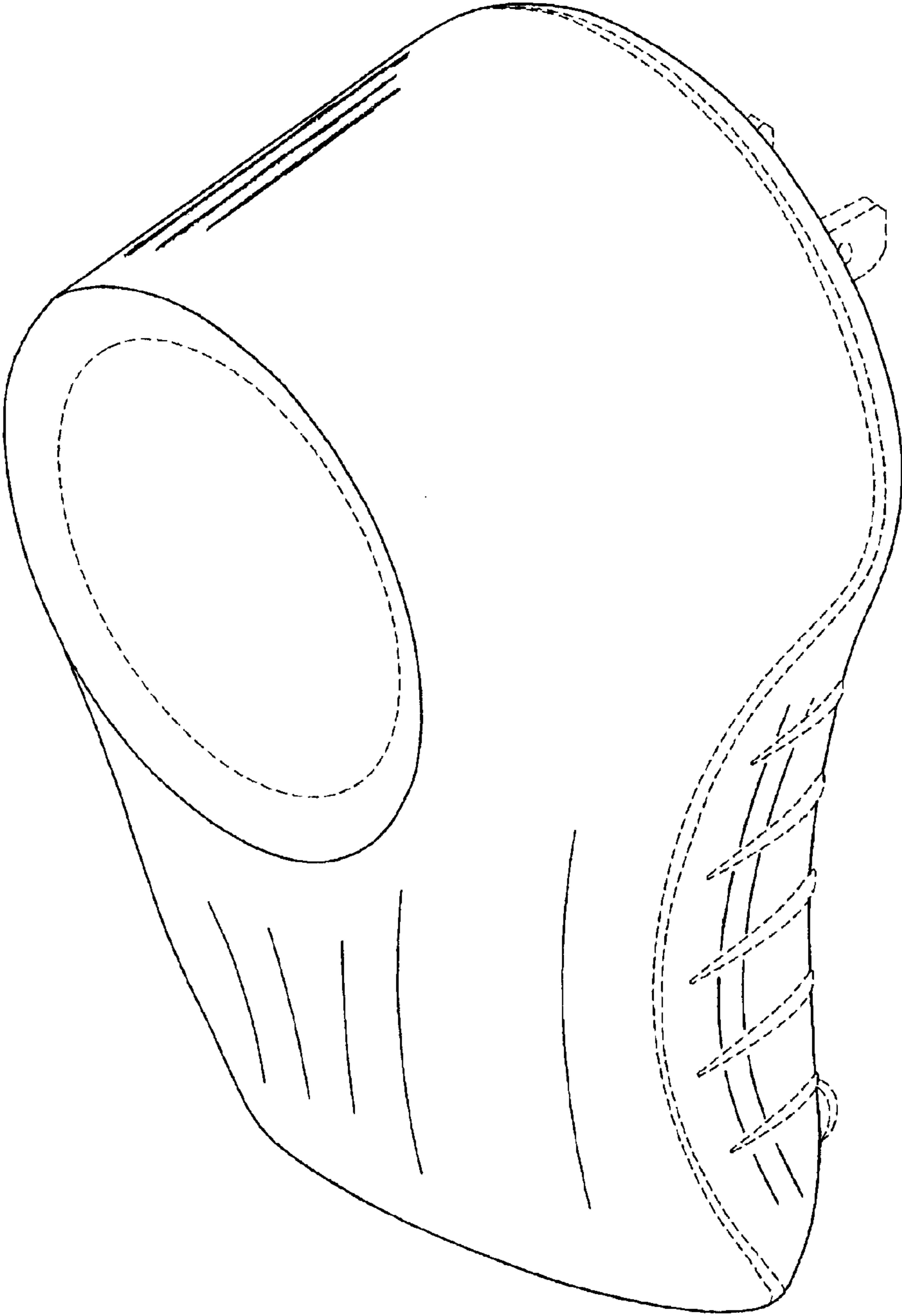

FIG. 1

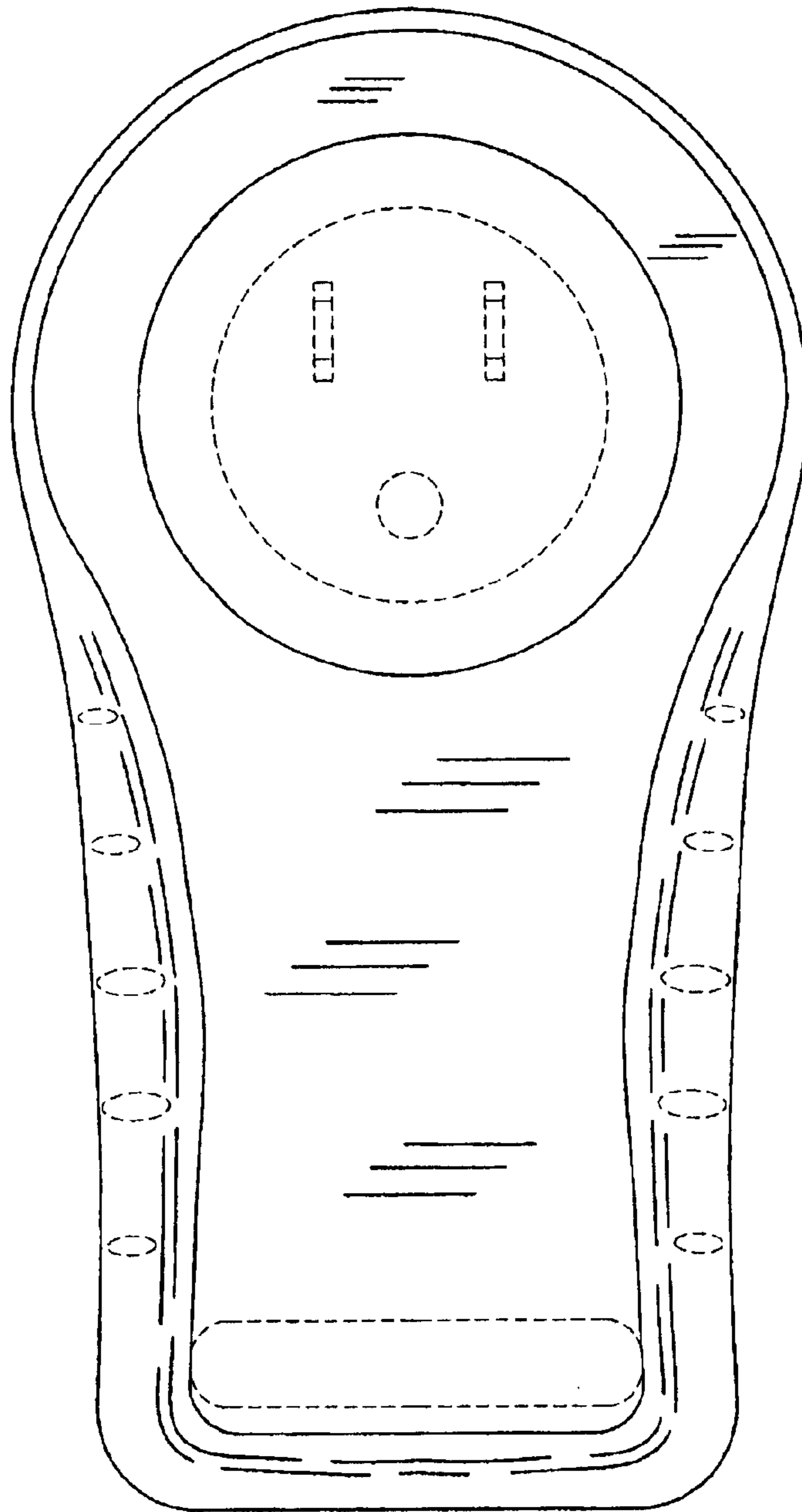

FIG. 2

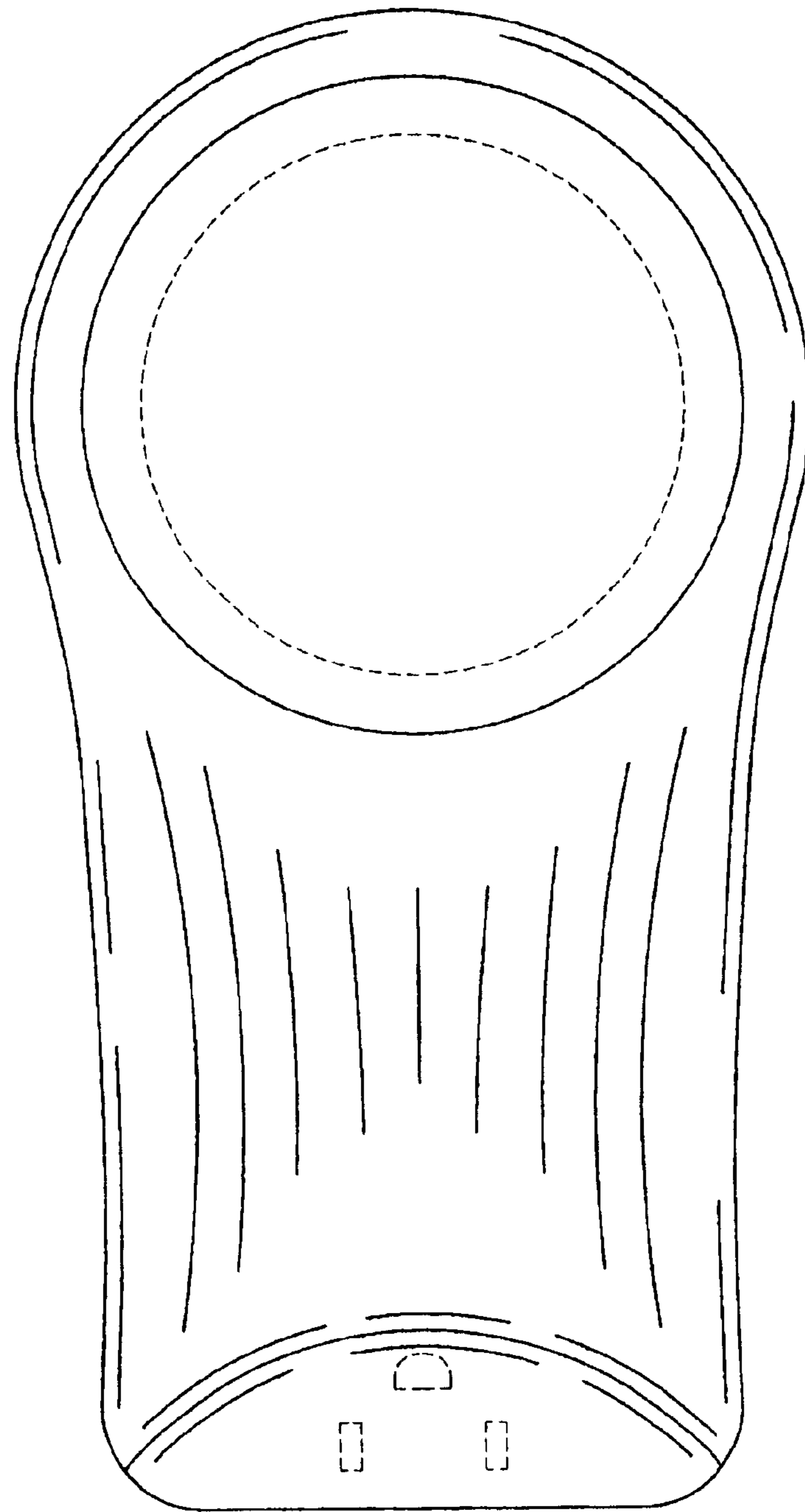

FIG. 3

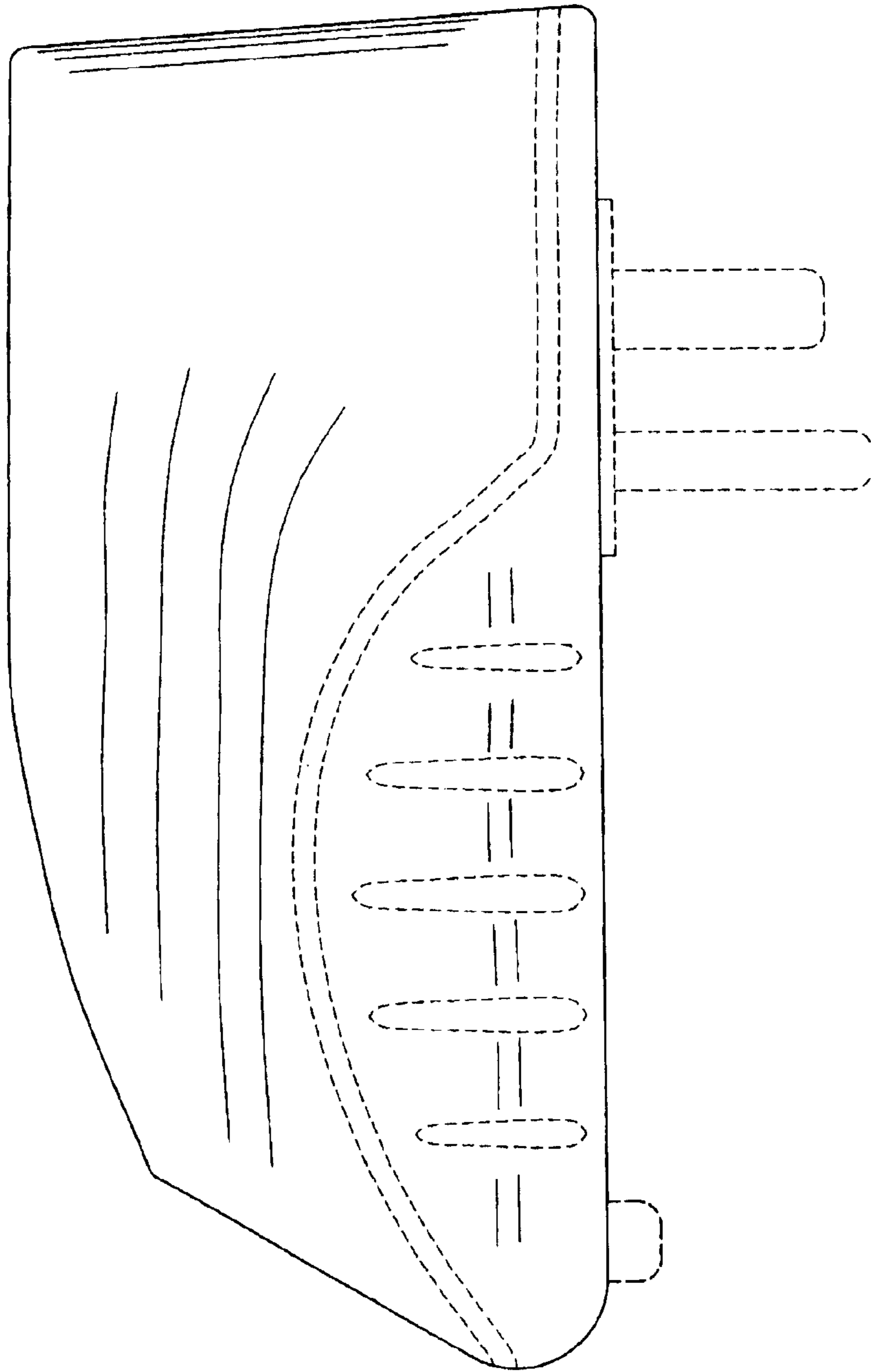

FIG. 4

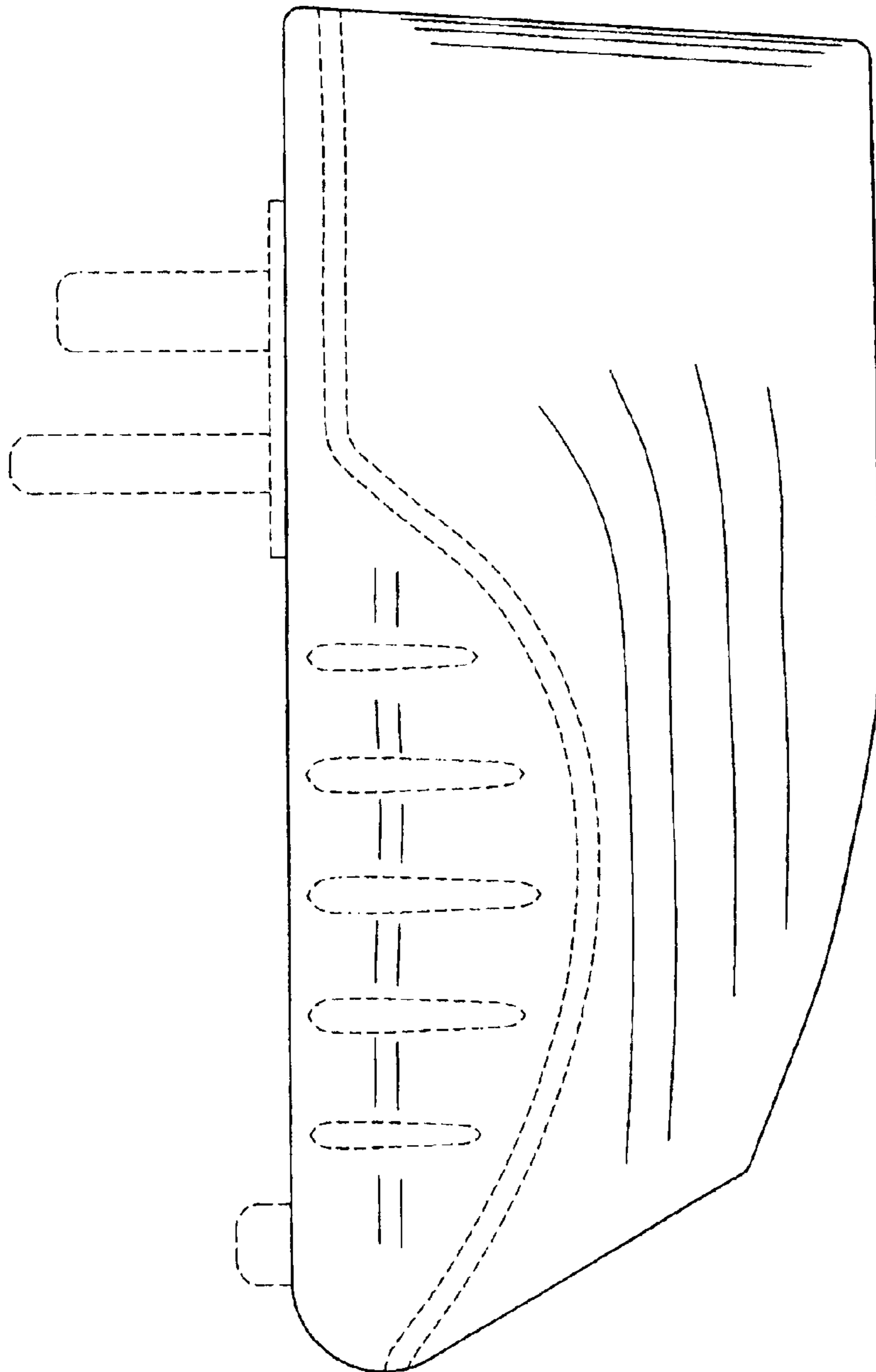

FIG. 5

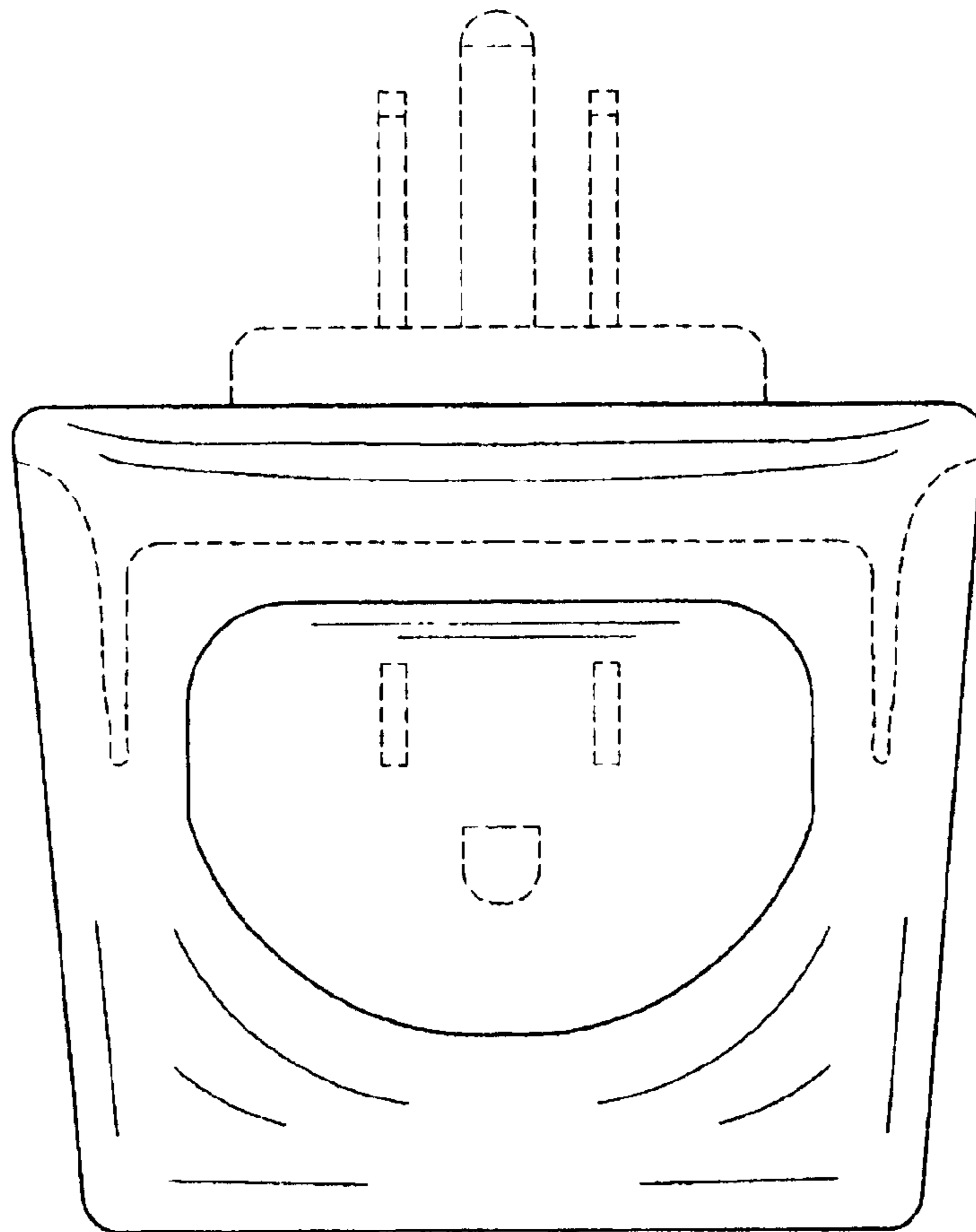

FIG. 6

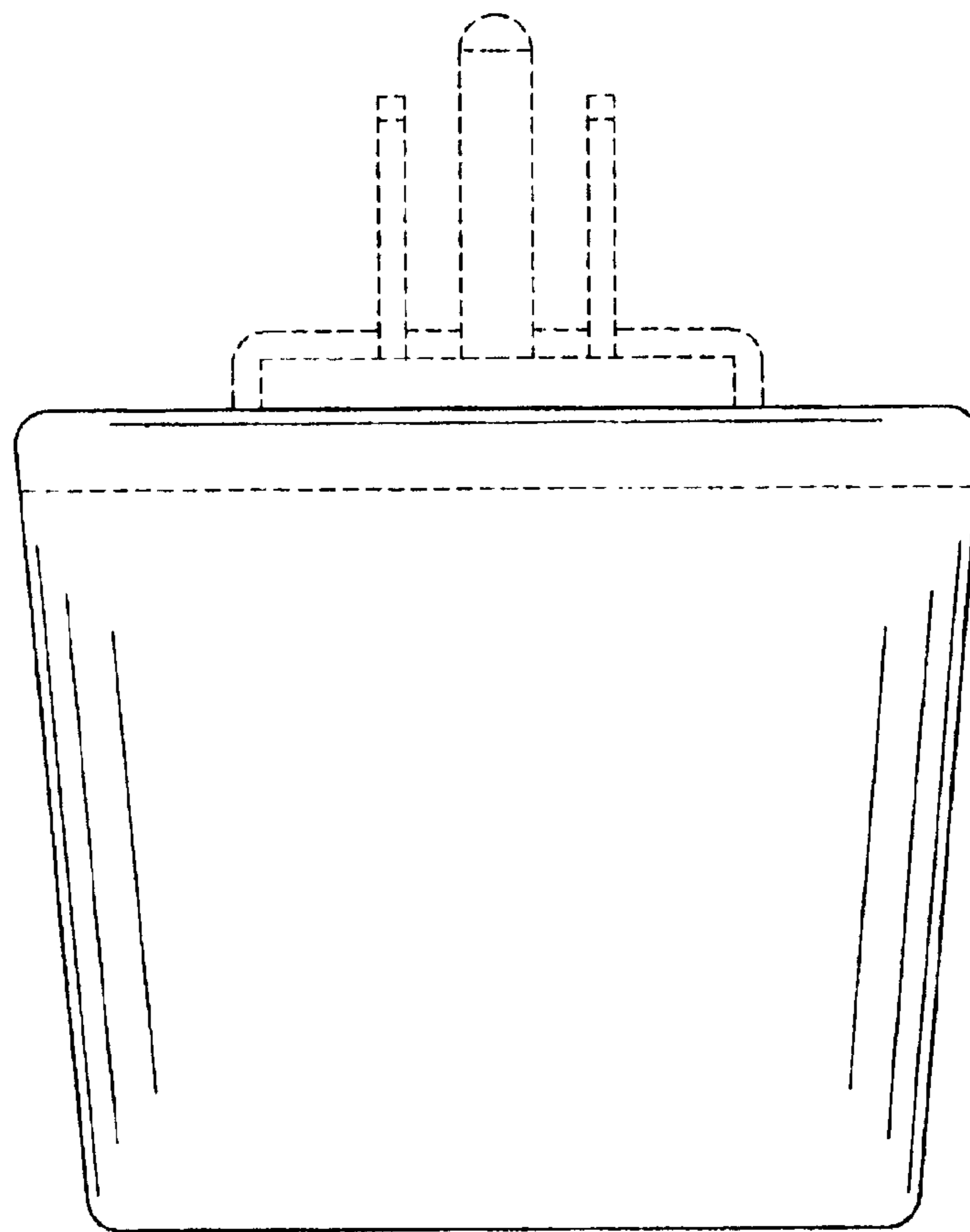

FIG. 7