

US00D541987S

(12) **United States Design Patent**  
**Sugawara**

(10) **Patent No.:** **US D541,987 S**

(45) **Date of Patent:** **\*\* May 1, 2007**

(54) **SAFETY RAZOR**

(75) Inventor: **Akira Sugawara**, Seki (JP)

(73) Assignee: **Kai R&D Center Co., Ltd.**, Gifu-ken (JP)

(\*\*) Term: **14 Years**

(21) Appl. No.: **29/262,876**

(22) Filed: **Jul. 13, 2006**

(30) **Foreign Application Priority Data**

Jan. 27, 2006 (JP) ..... 2006-001779

(51) **LOC (8) Cl.** ..... **28-03**

(52) **U.S. Cl.** ..... **D28/46**

(58) **Field of Classification Search** ..... 30/30,  
30/32, 34.05, 34.2, 41, 44, 47-51, 57, 526-528,  
30/532; D28/44, 44.1, 45-48

See application file for complete search history.

(56) **References Cited**

**U.S. PATENT DOCUMENTS**

D415,317 S \* 10/1999 Aiston ..... D28/48

D437,661 S \* 2/2001 Pinchuk ..... D28/48

D499,511 S \* 12/2004 Wakayama ..... D28/46

2002/0092175 A1 \* 7/2002 Kameka ..... 30/49

**FOREIGN PATENT DOCUMENTS**

JP A-1112184 4/2001

JP A-1129678 11/2001

JP A-1205932 5/2004

\* cited by examiner

*Primary Examiner*—Jennifer Rivard

(74) *Attorney, Agent, or Firm*—Posz Law Group, PLC

(57) **CLAIM**

The ornamental design for a safety razor, as shown and described.

**DESCRIPTION**

FIG. 1 is a front perspective view of a safety razor showing my new design;

FIG. 2 is a rear perspective view thereof;

FIG. 3 is a front view thereof, the rear view being a mirror image of FIG. 3;

FIG. 4 is a top plan view thereof;

FIG. 5 is a bottom plan view thereof;

FIG. 6 is a right side elevational view thereof;

FIG. 7 is a left side elevational view thereof;

FIG. 8 is an enlarged cross-sectional view taken along line 8—8 in FIG. 3;

FIG. 9 is an enlarged cross-sectional view taken along line 9—9 in FIG. 3;

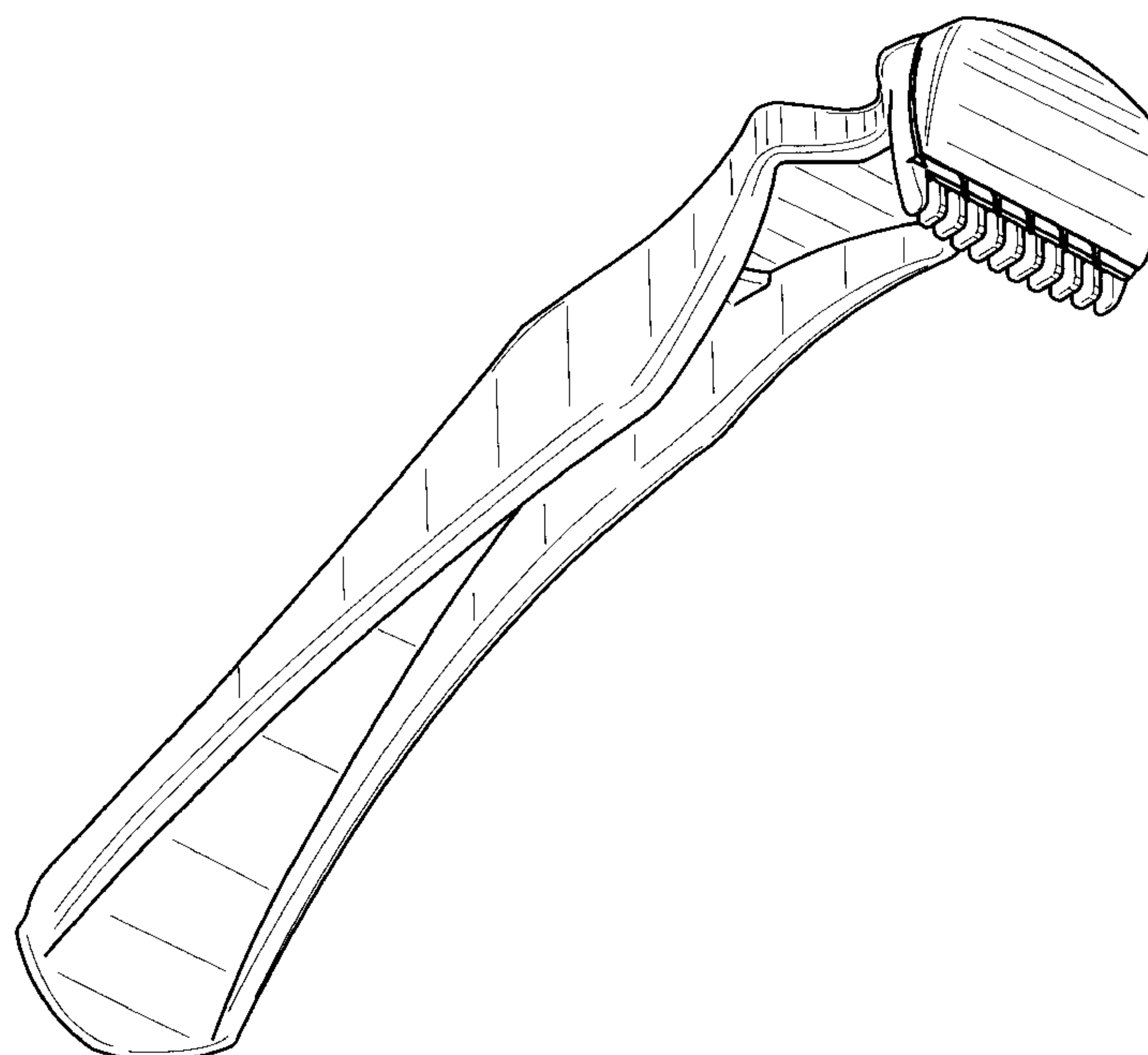
FIG. 10 is an enlarged cross-sectional view taken along line 10—10 in FIG. 3;

FIG. 11 is an enlarged cross-sectional view taken along line 11—11 in FIG. 4; and,

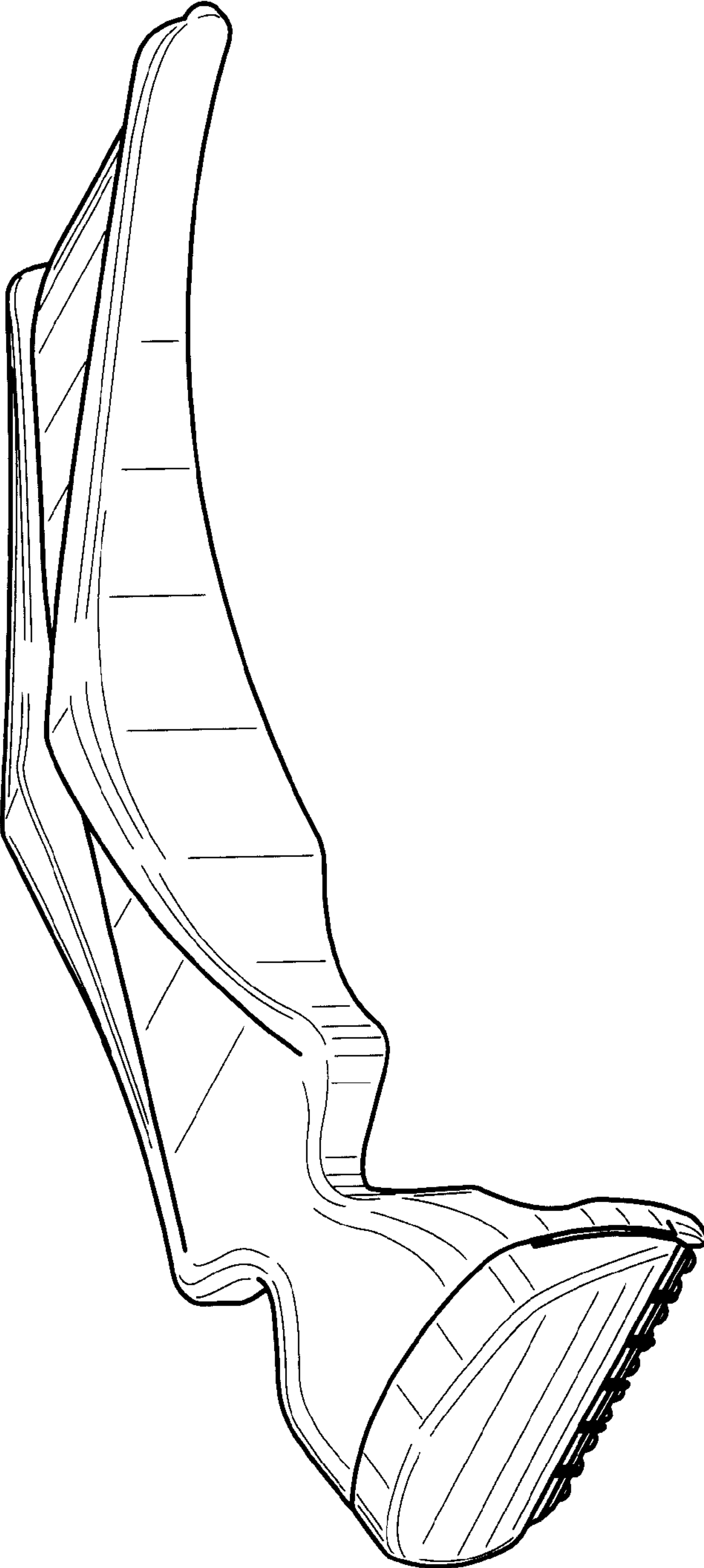
FIG. 12 is a left side elevational view of the safety razor with a cover.

The broken line in FIG. 12 is shown for illustrative purposes only and forms no part of the claimed design.

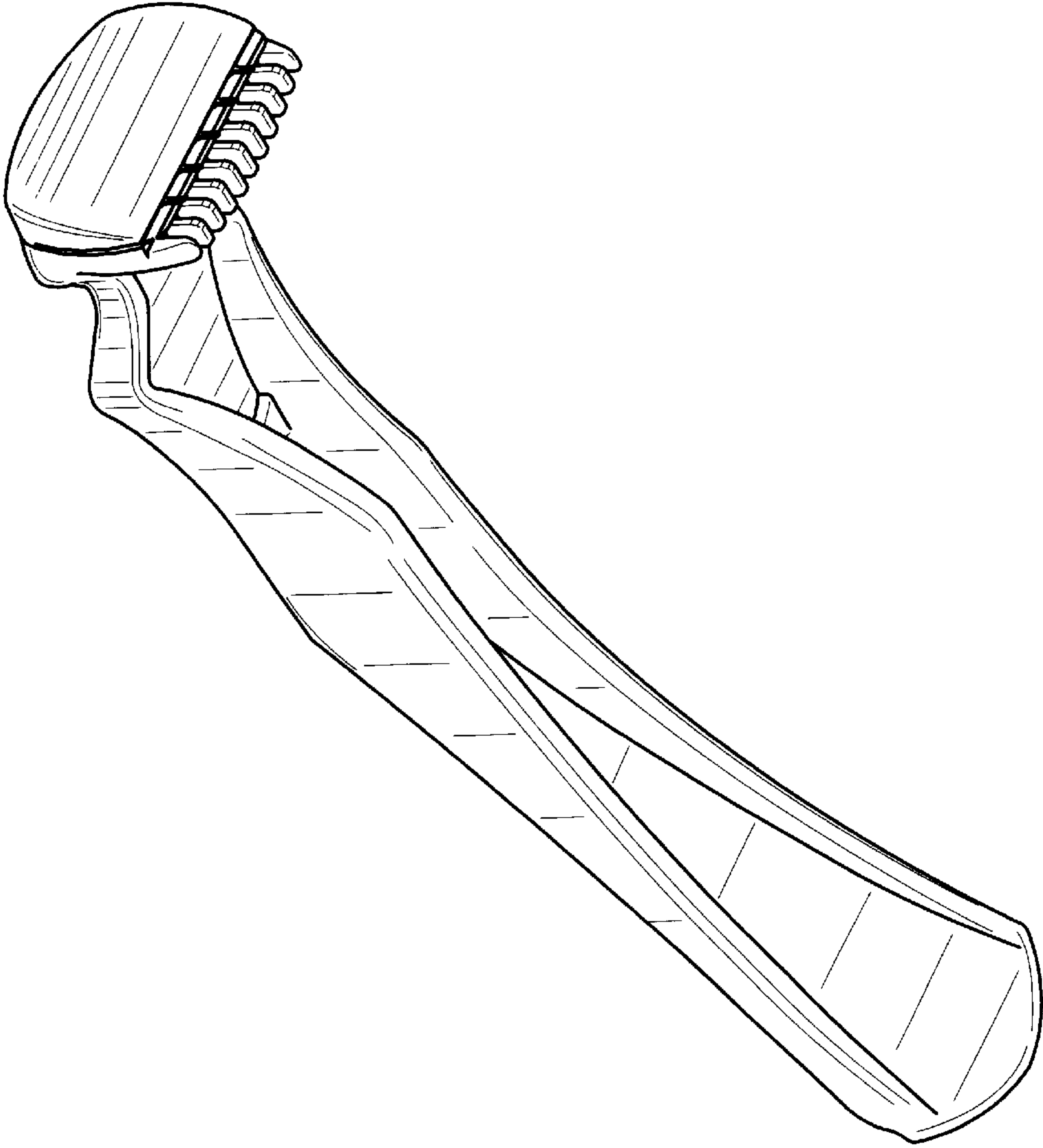
**1 Claim, 8 Drawing Sheets**



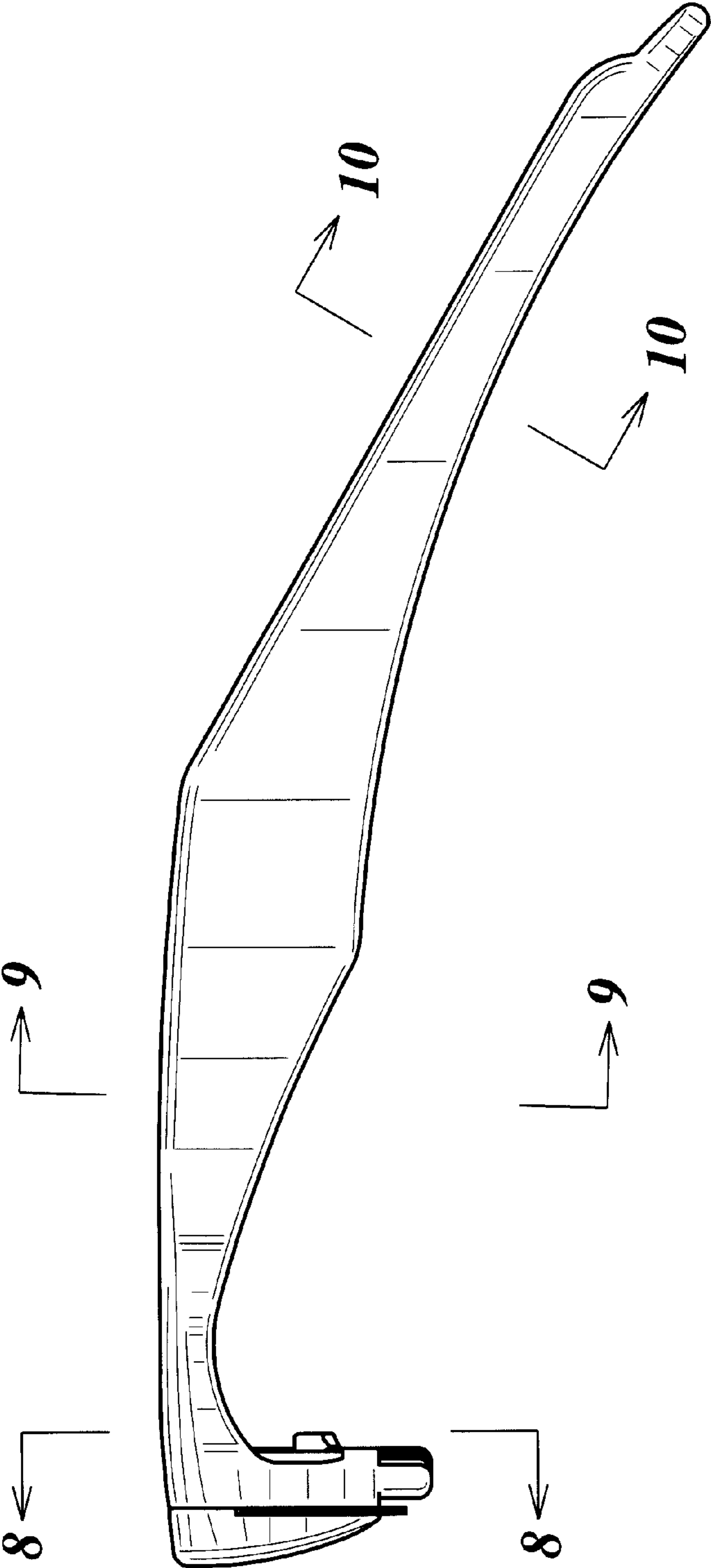
**FIG. 1**



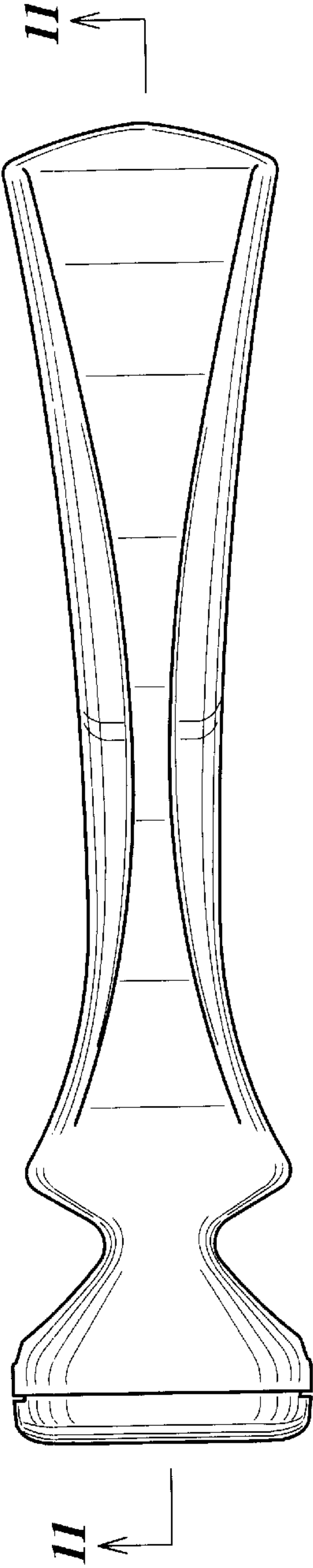
**FIG. 2**



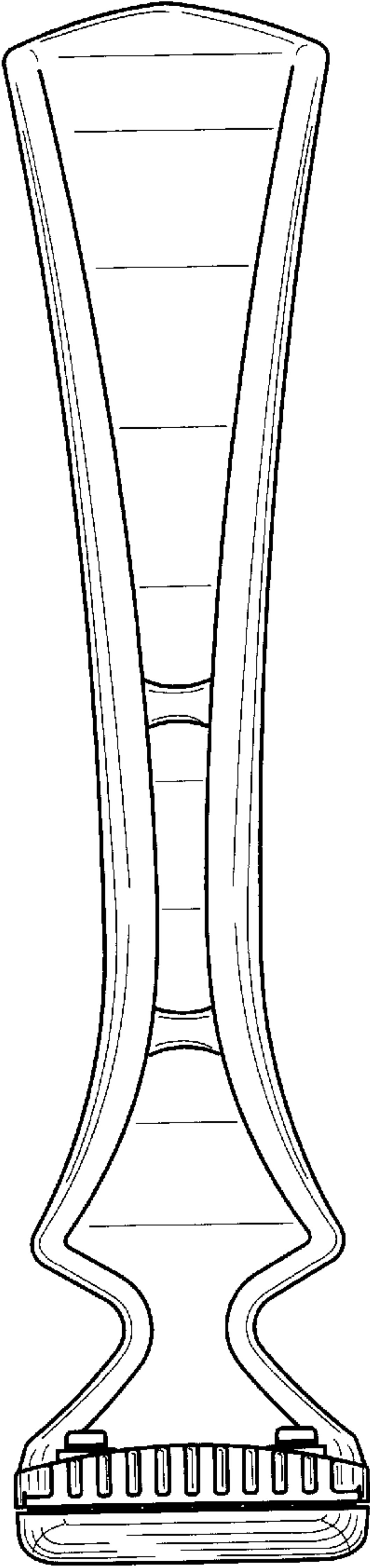
**FIG. 3**



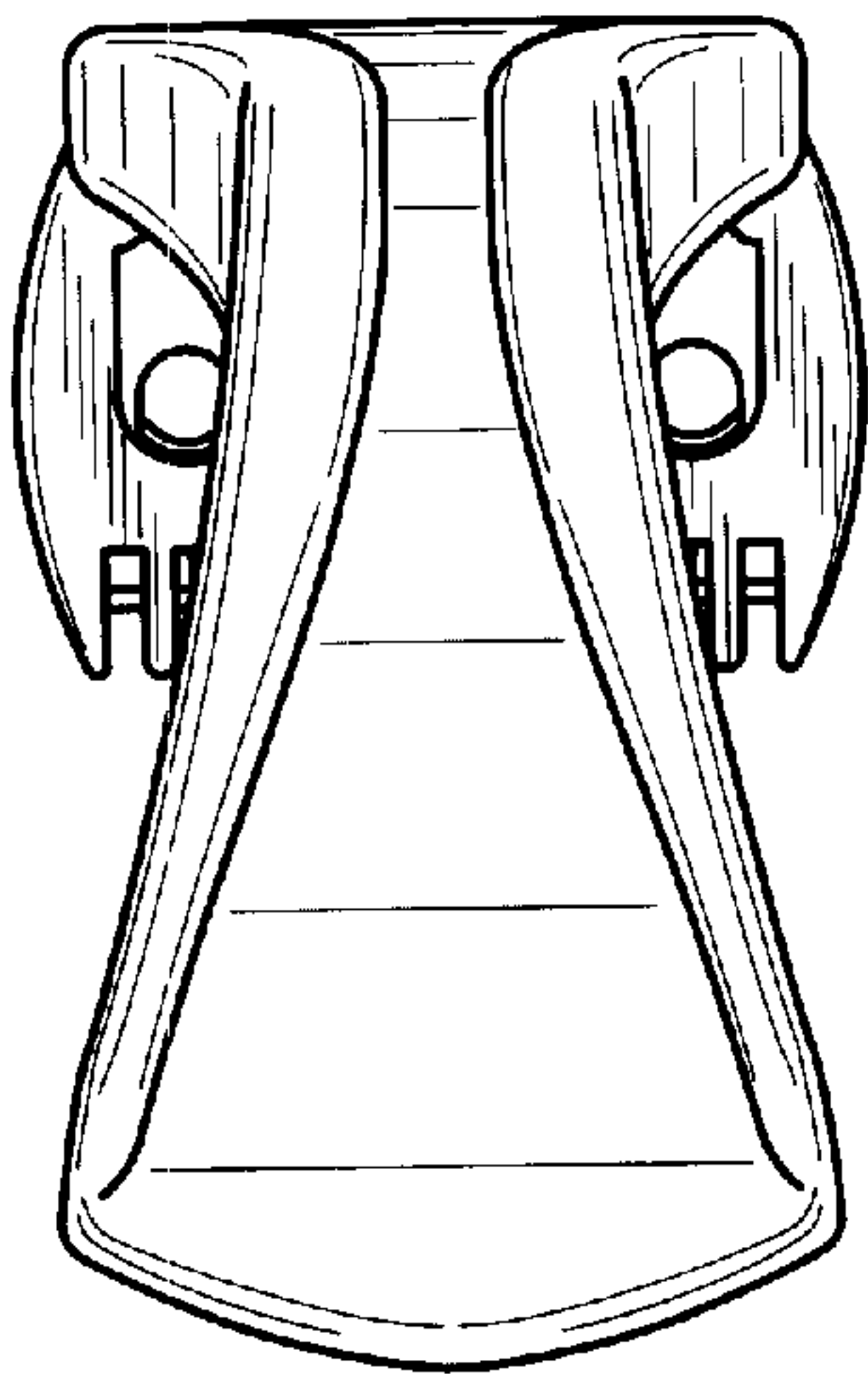
**FIG. 4**



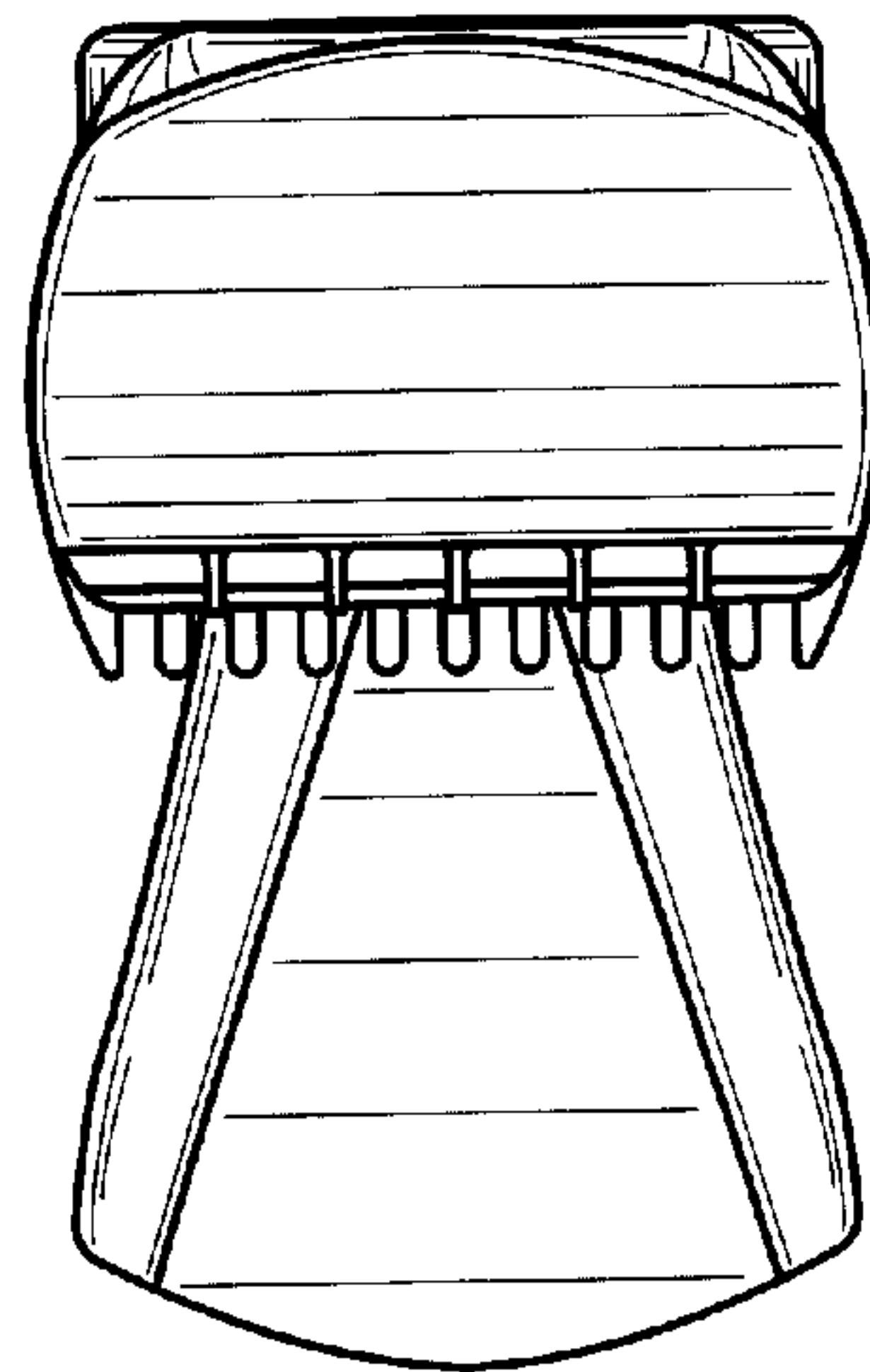
**FIG. 5**



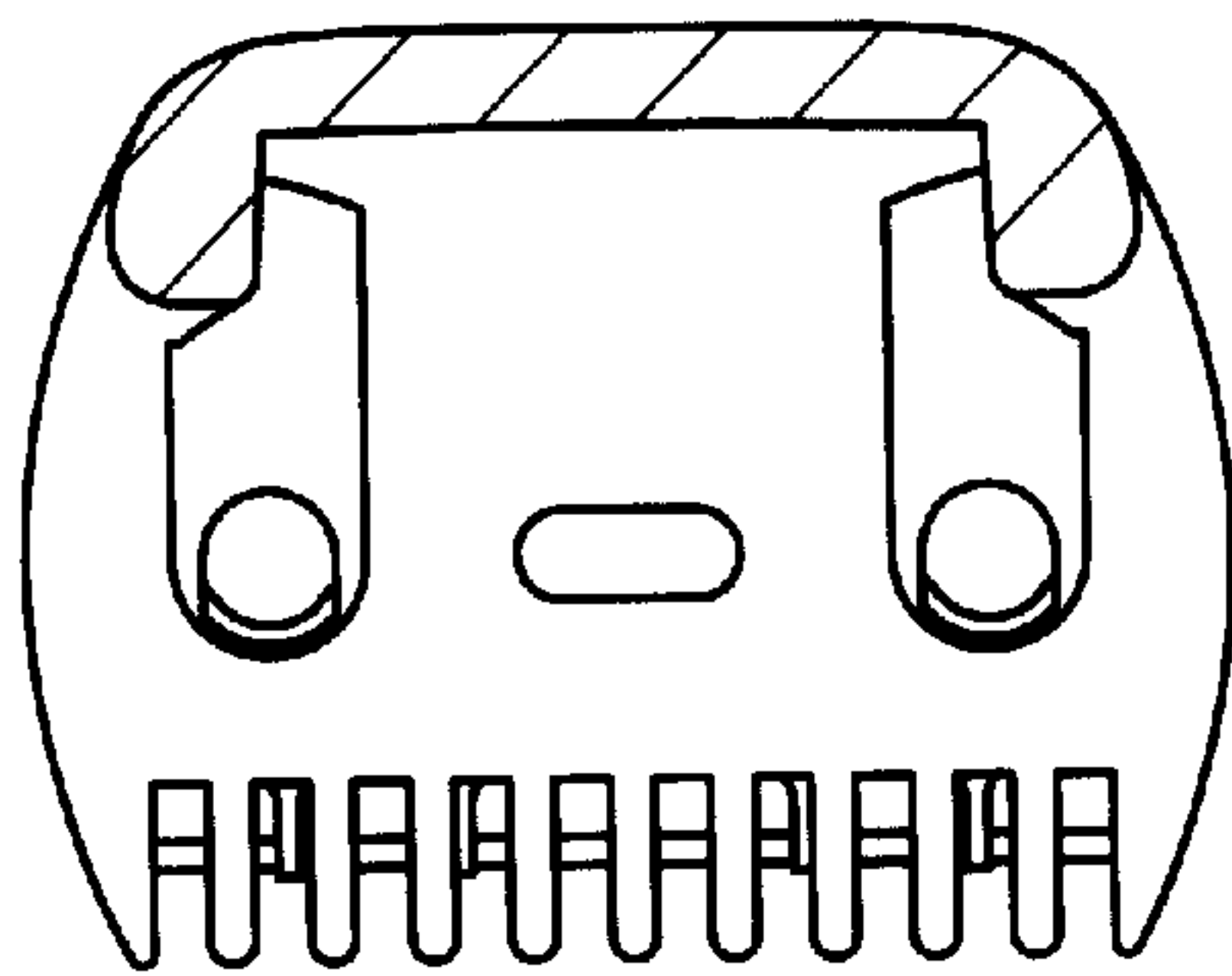
**FIG. 6**



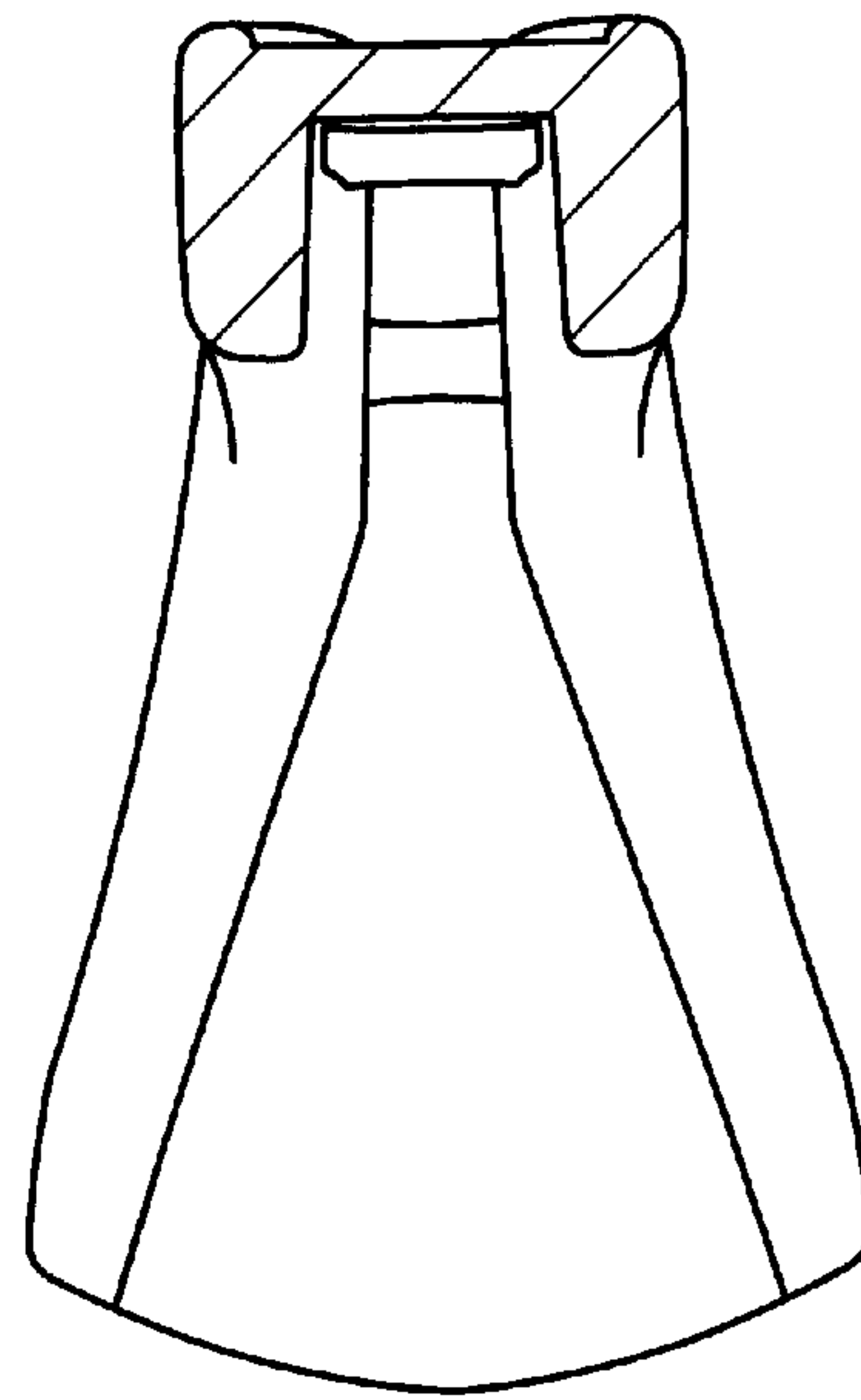
**FIG. 7**



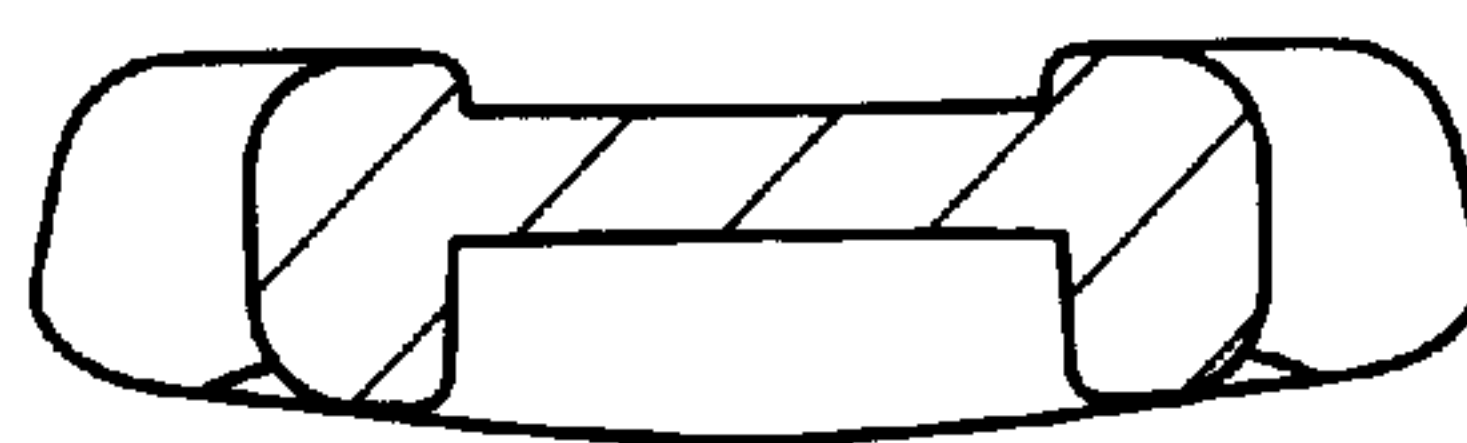
**FIG. 8**



**FIG. 9**

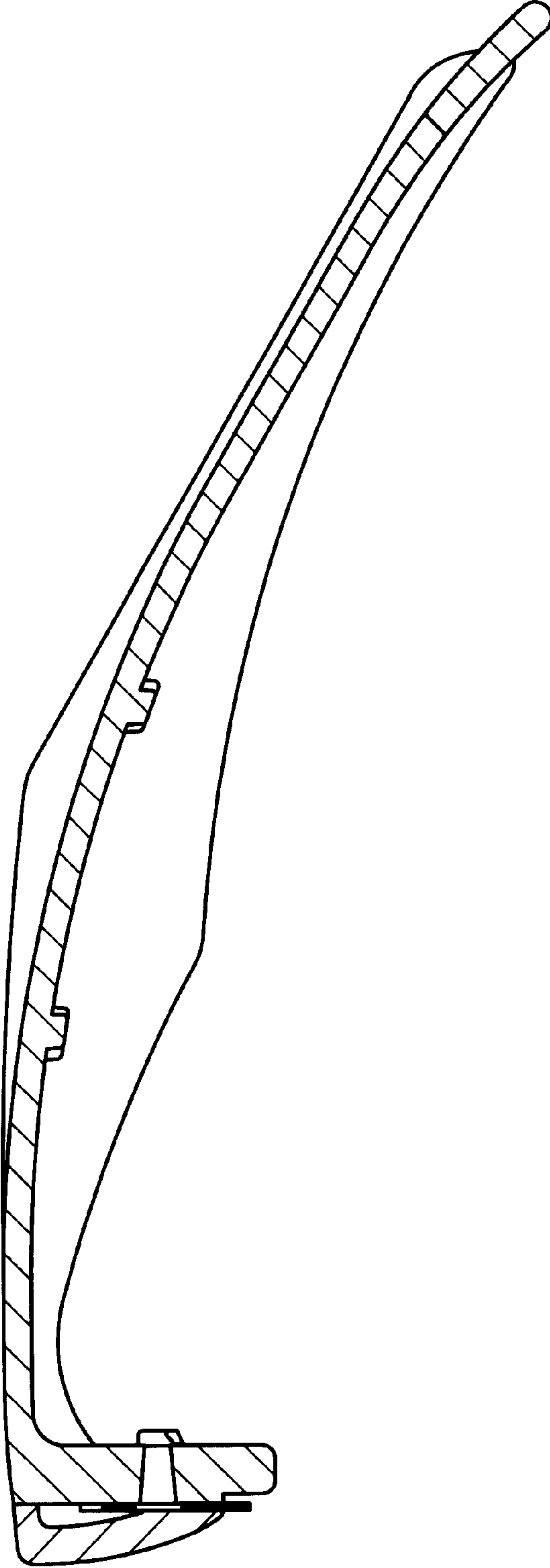


**FIG. 10**





**FIG. 11**





***FIG. 12***

