



US00D541940S

(12) **United States Design Patent** (10) **Patent No.:** **US D541,940 S**
Blain (45) **Date of Patent:** **** May 1, 2007**

(54) **INTERBODY FUSION DEVICE**

(75) Inventor: **Jason Blain**, Encinitas, CA (US)

(73) Assignee: **Spinal Elements, Inc.**, Carlsbad, CA (US)

(**) Term: **14 Years**

(21) Appl. No.: **29/257,474**

(22) Filed: **Apr. 3, 2006**

Related U.S. Application Data

(62) Division of application No. 29/242,035, filed on Nov. 4, 2005, now Pat. No. Des. 524,442.

(51) **LOC (8) Cl.** **24-03**

(52) **U.S. Cl.** **D24/155**

(58) **Field of Classification Search** D24/155;
606/61, 72, 74; 623/17.16, 17.17, 11.11
See application file for complete search history.

6,468,311	B2	*	10/2002	Boyd et al.	623/17.11
6,482,233	B1		11/2002	Aebi et al.		
6,491,724	B1	*	12/2002	Ferree	623/17.11
6,613,091	B1	*	9/2003	Zdeblick et al.	623/17.16
6,676,703	B2		1/2004	Biscup		
6,726,722	B2	*	4/2004	Walkenhorst et al.	623/17.16
6,730,127	B2		5/2004	Michelson		
D493,225	S		7/2004	Varga et al.		
D494,274	S		8/2004	Varga et al.		
D501,555	S		2/2005	Varga et al.		
6,964,687	B1	*	11/2005	Bernard et al.	623/17.16
6,979,353	B2	*	12/2005	Bresina	623/17.16
2002/0099376	A1		7/2002	Michelson		
2002/0103540	A1		8/2002	Cooper et al.		
2002/0143400	A1		10/2002	Biscup		
2003/0114931	A1		6/2003	Lee et al.		
2003/0139812	A1		7/2003	Garcia et al.		
2004/0117020	A1		6/2004	Frey et al.		
2004/0127990	A1		7/2004	Bartish, Jr. et al.		
2005/0004671	A1		1/2005	Ross et al.		
2005/0027360	A1		2/2005	Webb et al.		
2005/0038431	A1		2/2005	Bartish et al.		
2005/0096745	A1		5/2005	Andre et al.		

* cited by examiner

Primary Examiner—Charles A. Rademaker
(74) *Attorney, Agent, or Firm*—Knobbe Martens Olson & Bear LLP

(56) **References Cited**

U.S. PATENT DOCUMENTS

5,425,772	A	6/1995	Brantigan	
5,443,514	A	8/1995	Steffee	
5,484,437	A	1/1996	Michelson	
5,658,337	A	8/1997	Kohrs et al.	
5,669,909	A	9/1997	Zdeblick et al.	
5,782,919	A	7/1998	Zdeblick et al.	
5,888,223	A	3/1999	Bray, Jr.	
5,888,224	A	3/1999	Beckers et al.	
D411,009	S	* 6/1999	Asfora D24/155
5,984,967	A	11/1999	Zdeblick et al.	
6,080,158	A	6/2000	Lin	
6,120,502	A	9/2000	Michelson	
6,132,465	A	10/2000	Ray et al.	
6,231,610	B1	5/2001	Geisler	
6,235,059	B1	5/2001	Benezech et al.	
6,245,108	B1	6/2001	Biscup	
6,290,724	B1	9/2001	Marino	
6,325,827	B1	12/2001	Lin	
6,342,055	B1	1/2002	Eisermann et al.	
6,375,655	B1	* 4/2002	Zdeblick et al. 623/17.16
6,387,099	B1	* 5/2002	Lange et al. 606/74
6,432,106	B1	8/2002	Fraser	

(57) **CLAIM**

The ornamental design for an interbody fusion device, as shown and described.

DESCRIPTION

FIG. 1 is a rear perspective view of an interbody fusion device showing my new design;
FIG. 2 is a front elevation thereof;
FIG. 3 is a rear elevation thereof;
FIG. 4 is a right-side elevation thereof; the side opposite being a mirror-image;
FIG. 5 is a top plan view thereof; and,
FIG. 6 is a bottom plan view thereof.
The broken lines which define the bounds of the claimed design form no part thereof.

1 Claim, 4 Drawing Sheets

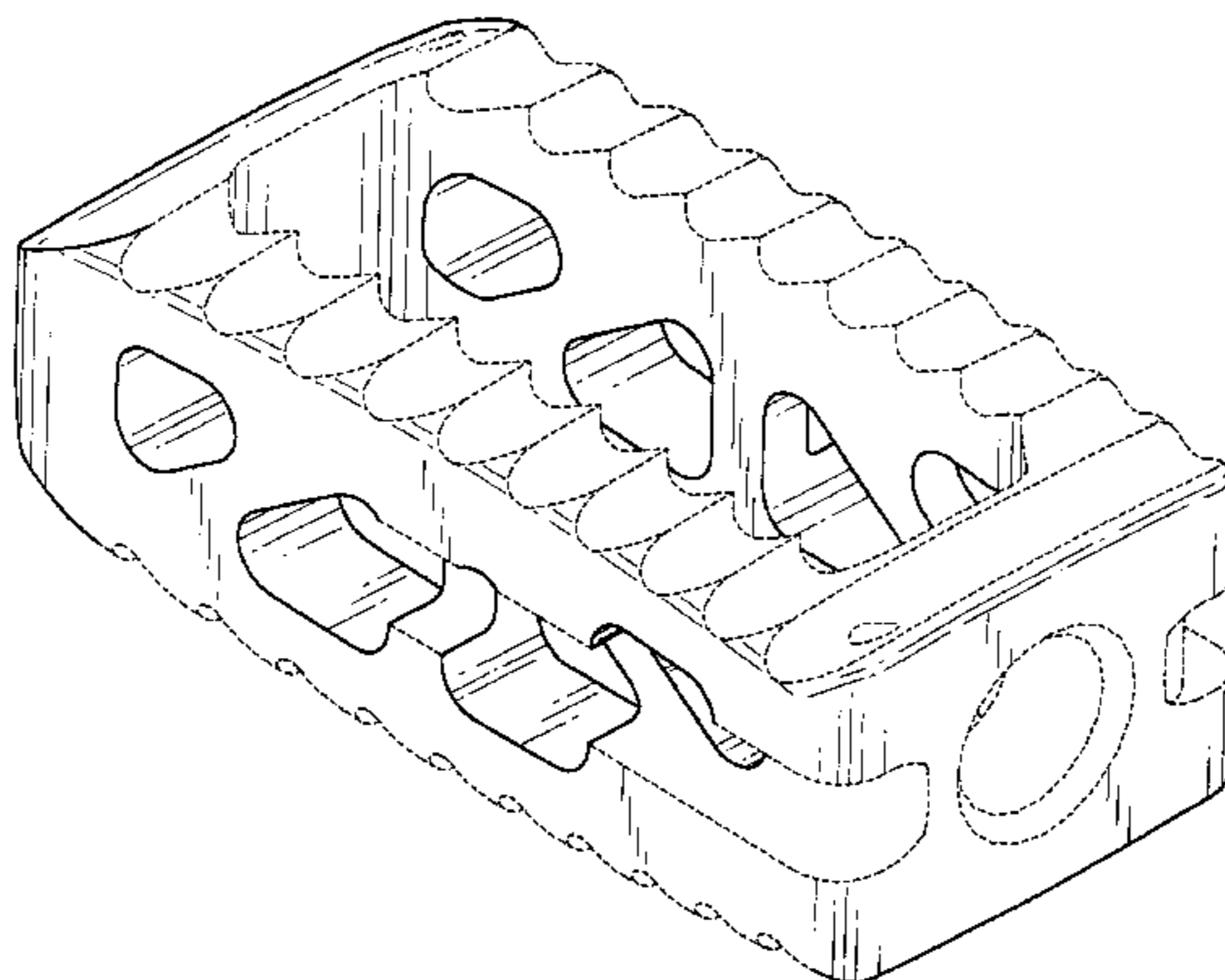

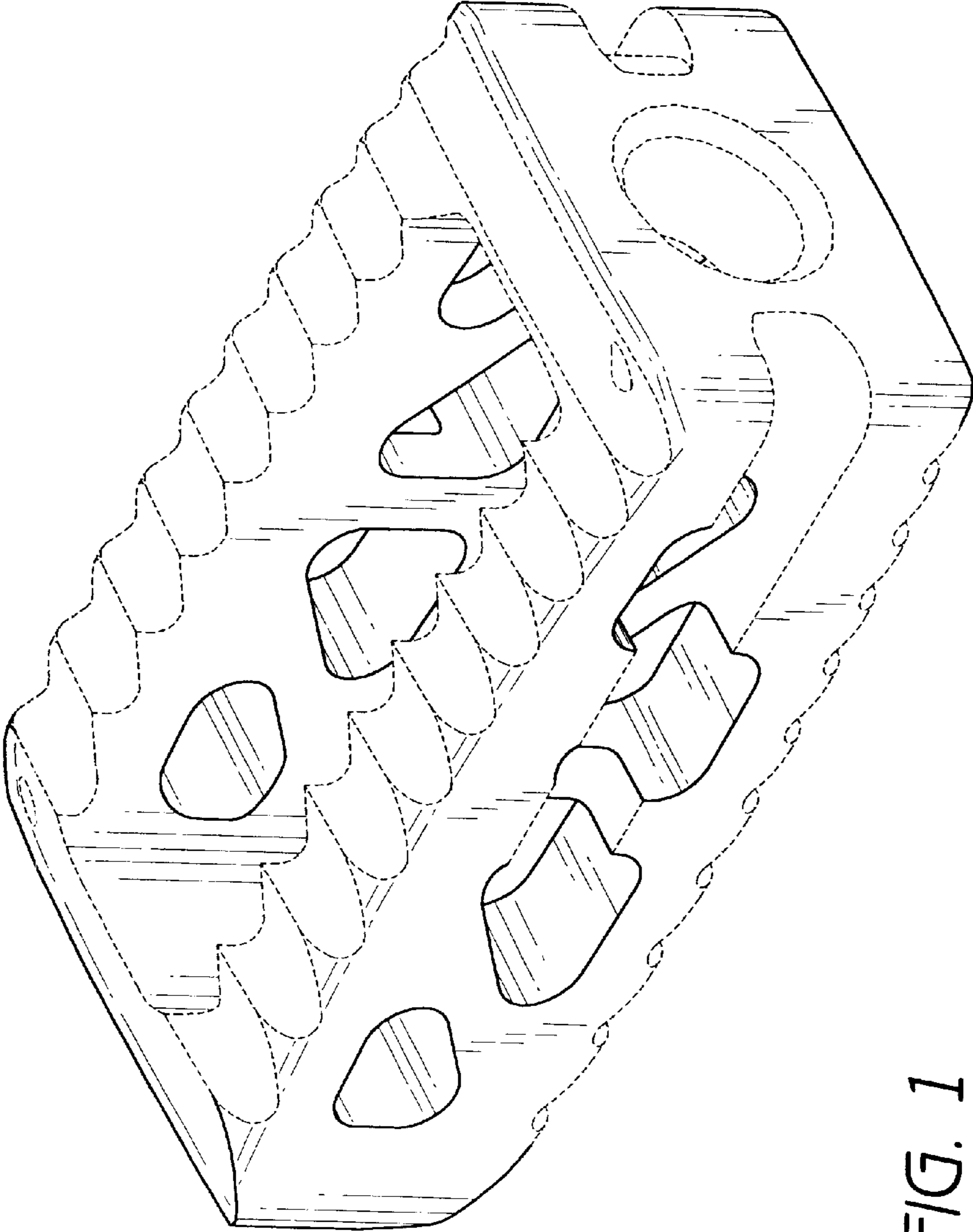

FIG. 1

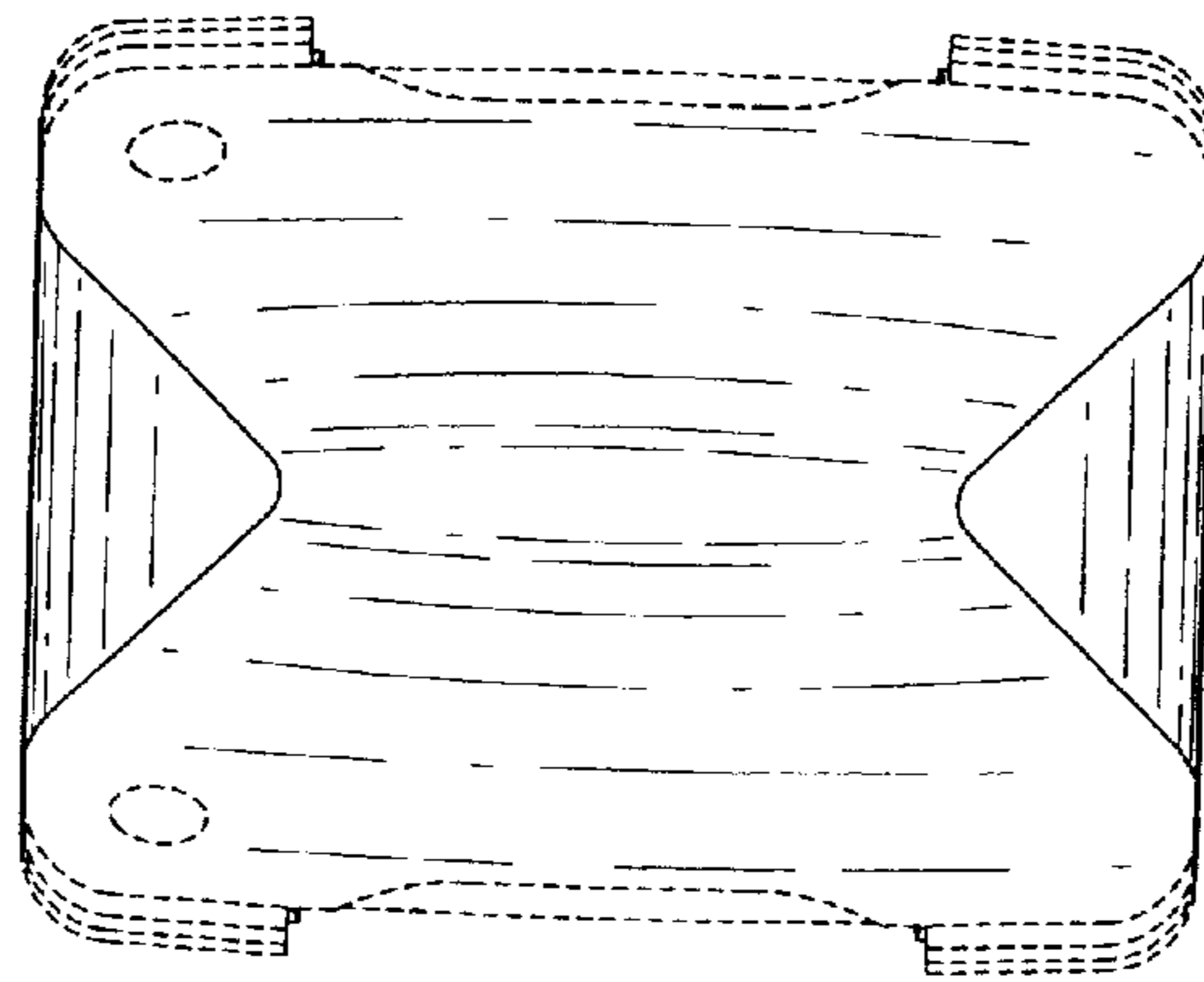

FIG. 2

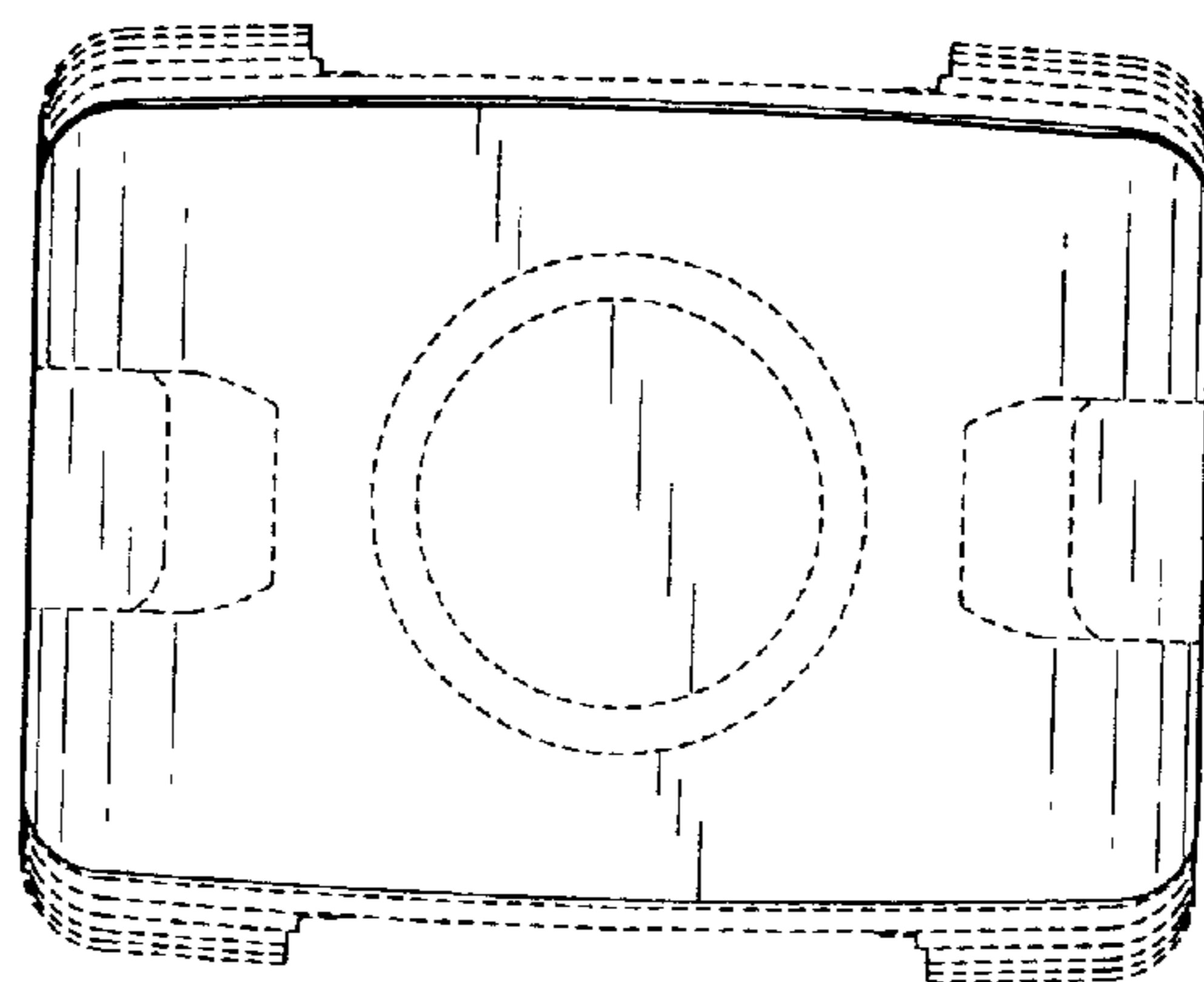

FIG. 3

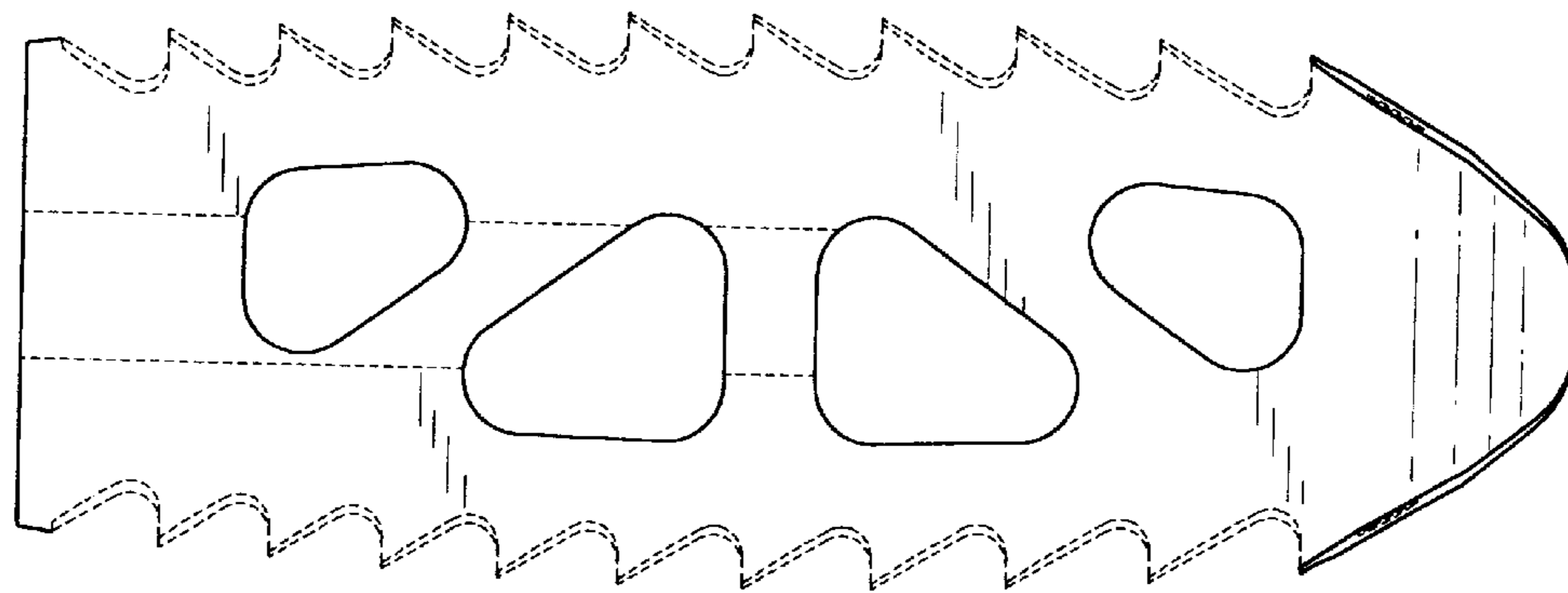

FIG. 4

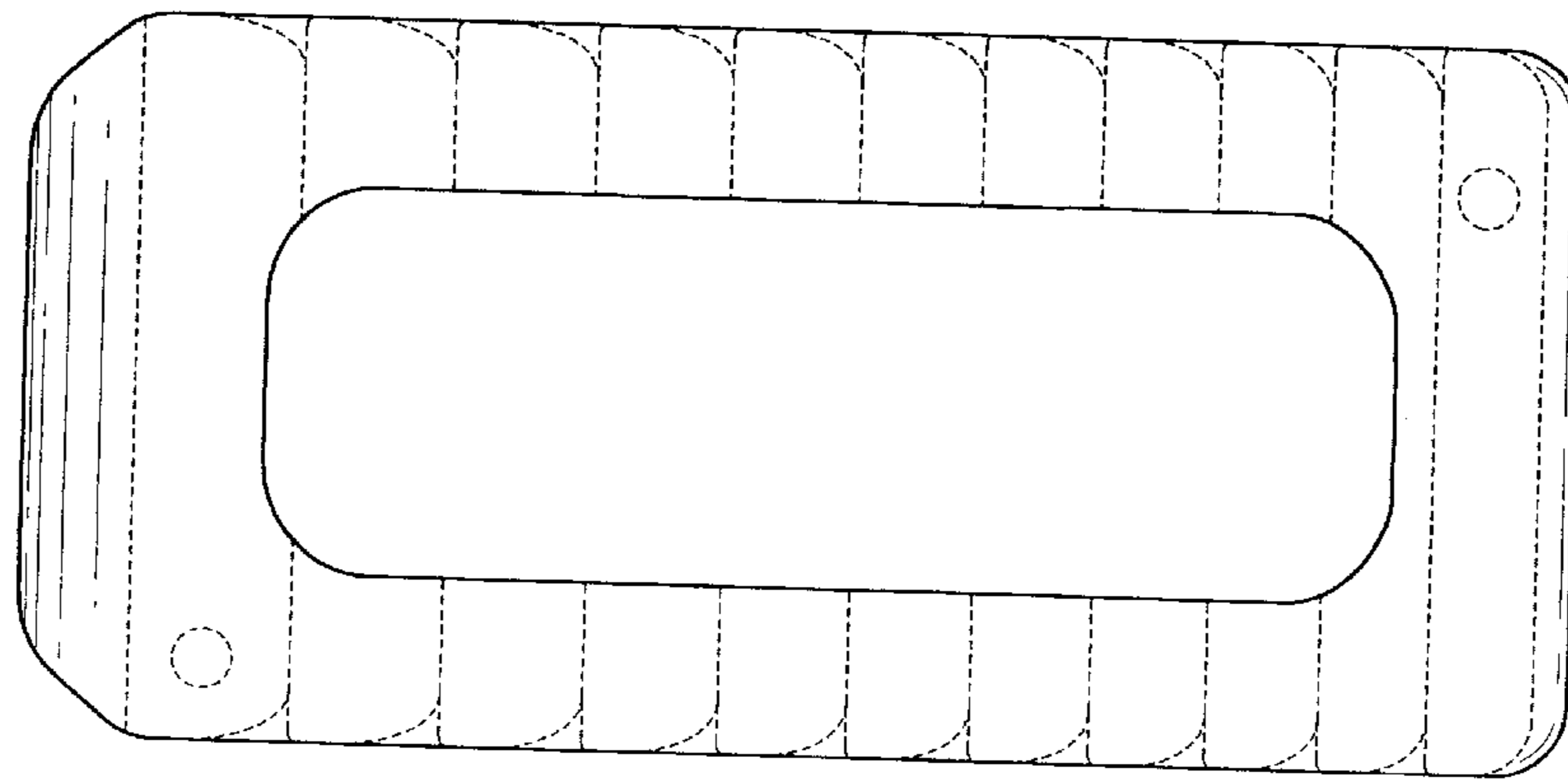

FIG. 5

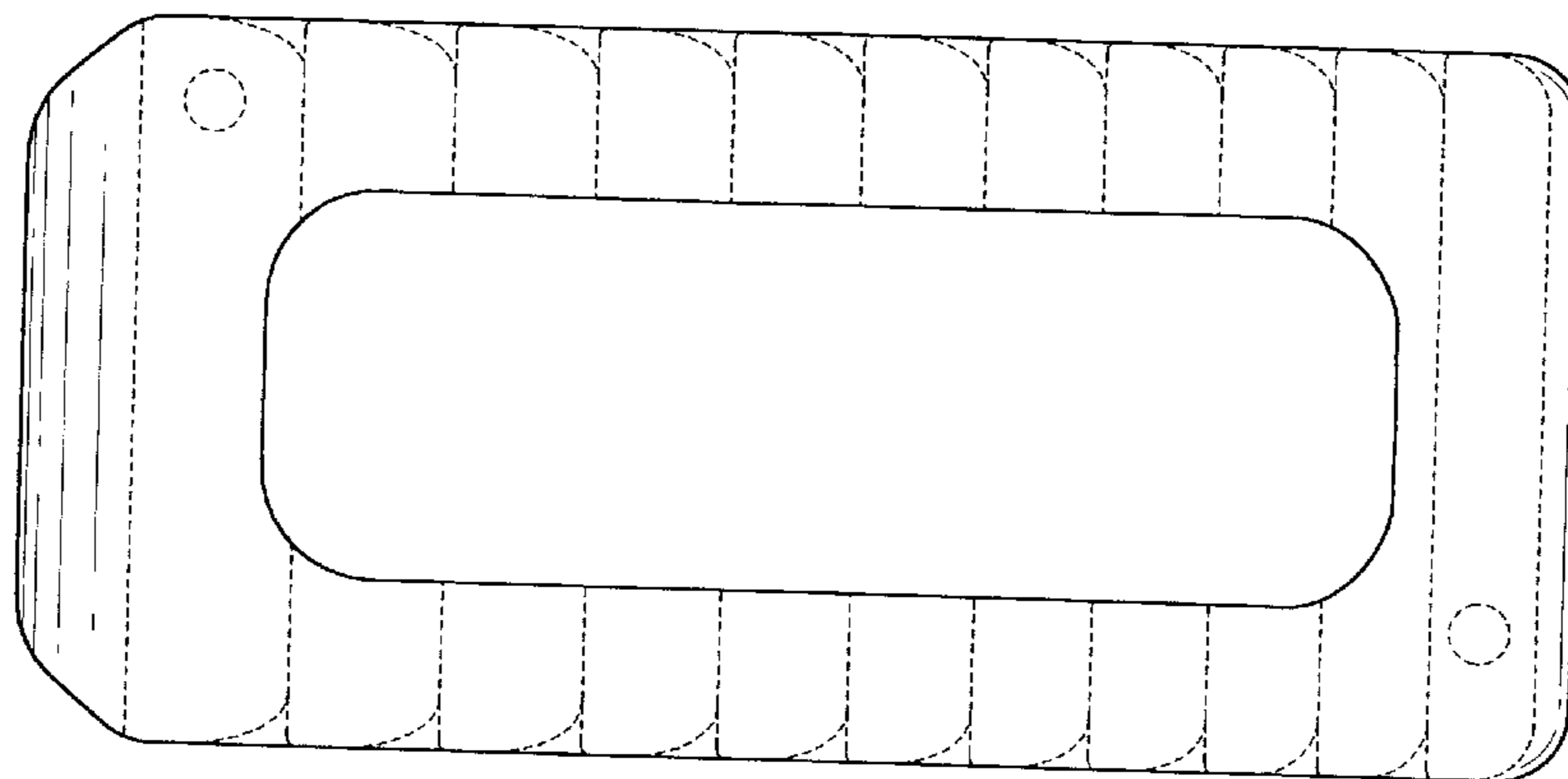

FIG. 6