



US00D541938S

(12) **United States Design Patent**
Kerr et al.

(10) **Patent No.:** **US D541,938 S**

(45) **Date of Patent:** **** May 1, 2007**

(54) **OPEN VESSEL SEALER WITH MECHANICAL CUTTER**

(75) Inventors: **Duane E. Kerr**, Berthoud, CO (US);
Paul R. Romero, Loveland, CO (US);
Michael C. Moses, Boulder, CO (US)

(73) Assignee: **Sherwood Services AG**, Schaffhausen (CH)

(**) Term: **14 Years**

(21) Appl. No.: **29/203,179**

(22) Filed: **Apr. 9, 2004**

(51) **LOC (8) Cl.** **24-02**

(52) **U.S. Cl.** **D24/144; D24/133**

(58) **Field of Classification Search** D24/144,
D24/133, 146, 147, 149, 143, 153; 606/51,
606/52, 41, 44, 48, 171, 205, 206, 207
See application file for complete search history.

(56) **References Cited**

U.S. PATENT DOCUMENTS

371,664 A 10/1887 Brannan et al.
702,472 A 6/1902 Pignolet

(Continued)

FOREIGN PATENT DOCUMENTS

CA 2104423 2/1994
DE 2415263 10/1975

(Continued)

OTHER PUBLICATIONS

Sigel et al. "The Mechanism of Blood Vessel Closure by High Frequency Electrocoagulation" *Surgery Gynecology & Obstetrics*, Oct. 1965 pp. 823-831.

Bergdahl et al. "Studies on Coagulation and the Development of an Automatic Computerized Bipolar Coagulator" *J. Neurosurg.*, vol. 75, Jul. 1991, pp. 148-151.

(Continued)

Primary Examiner—Ian Simmons
Assistant Examiner—Christopher Lee

(57) **CLAIM**

We claim the ornamental design for an open vessel sealer with mechanical cutter, as shown.

DESCRIPTION

FIG. 1 is a perspective view of an open vessel sealer with mechanical cutter showing our new design;

FIG. 2 is a right side view of the open vessel sealer with mechanical cutter;

FIG. 3 is a left side view of the open vessel sealer with mechanical cutter;

FIG. 4 is a bottom view of the open vessel sealer with mechanical cutter;

FIG. 5 is a top view of the open vessel sealer with mechanical cutter;

FIG. 6 is a front view of the open vessel sealer with mechanical cutter; and,

FIG. 7 is a rear view of the open vessel sealer with mechanical cutter.

1 Claim, 5 Drawing Sheets

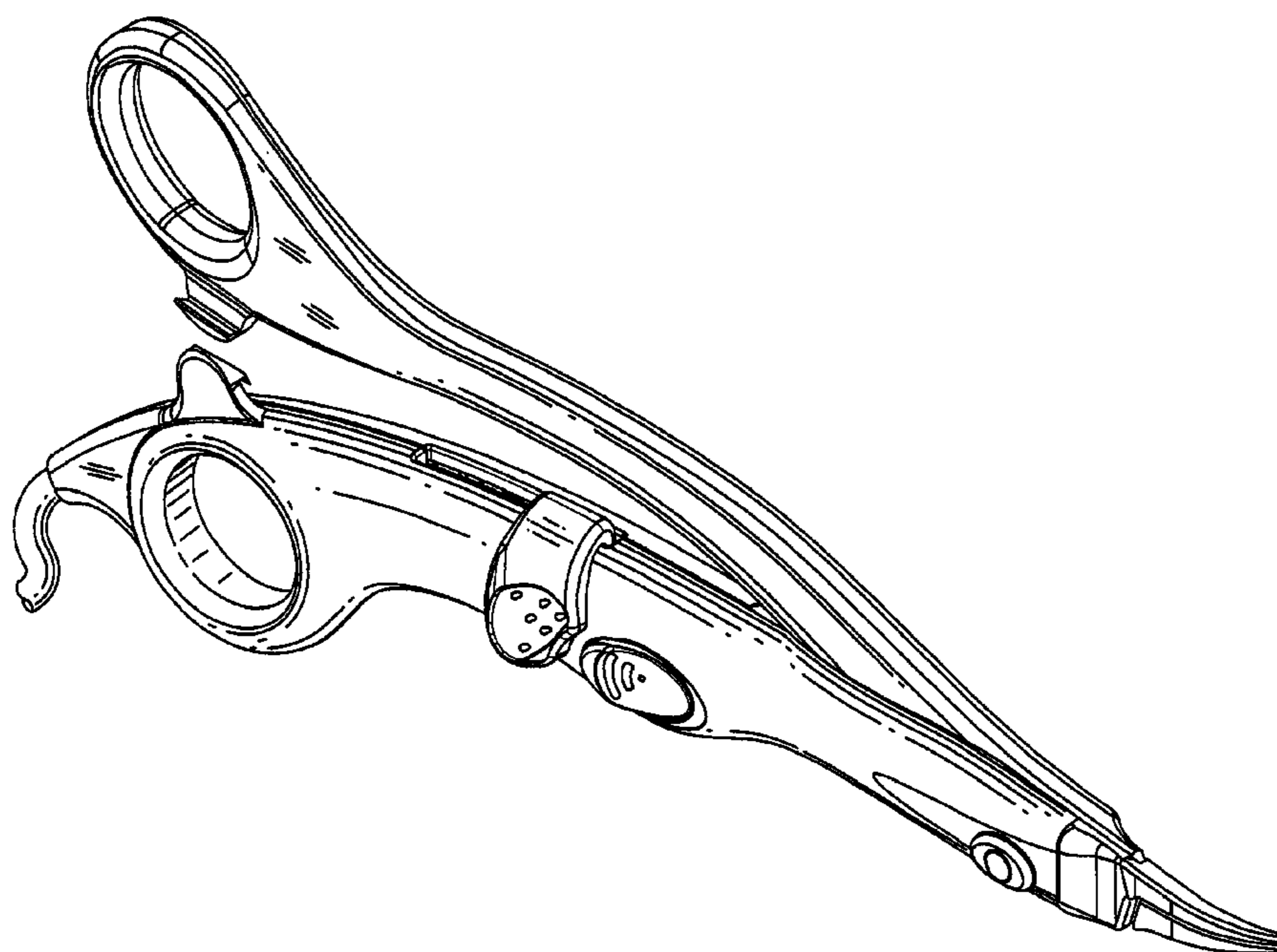

US D541,938 S

Page 2

U.S. PATENT DOCUMENTS							
728,883	A	5/1903	Downes	5,334,215	A	8/1994	Chen
1,586,645	A	6/1926	Bierman	5,336,221	A	8/1994	Anderson
2,002,594	A	5/1935	Wappler et al.	5,342,359	A	8/1994	Rydell
2,011,169	A	8/1935	Wappler	5,342,381	A	8/1994	Tidemand
2,031,682	A	2/1936	Wappler et al.	5,342,393	A	8/1994	Stack
2,176,479	A	10/1939	Willis	5,352,222	A	10/1994	Rydell
2,305,156	A	12/1942	Grubel	5,354,271	A	10/1994	Voda
2,632,661	A	3/1953	Cristofv	5,356,408	A	10/1994	Rydell
2,668,538	A	2/1954	Baker	5,366,477	A	11/1994	LeMarie, III et al.
2,796,065	A	6/1957	Kapp	5,383,897	A	1/1995	Wholey
3,459,187	A	8/1969	Pallotta	5,389,098	A	2/1995	Tsuruta et al.
3,643,663	A	2/1972	Sutter	5,389,104	A	2/1995	Hahnen et al.
3,651,811	A	3/1972	Hildebrandt et al.	5,391,166	A	2/1995	Eggers
3,862,630	A	1/1975	Balamuth	5,391,183	A	2/1995	Janzen et al.
3,866,610	A	2/1975	Kletschka	5,403,312	A	4/1995	Yates et al.
3,911,766	A	10/1975	Fridolph et al.	5,411,519	A	5/1995	Tovey et al.
3,920,021	A	11/1975	Hiltebrandt	5,411,520	A	5/1995	Nash et al.
3,921,641	A	11/1975	Hulka	5,413,571	A	5/1995	Katsaros et al.
3,938,527	A	2/1976	Rioux et al.	5,415,657	A	5/1995	Taymor-Luria
3,952,749	A	4/1976	Fridolph et al.	5,422,567	A	6/1995	Matsunaga
4,005,714	A	2/1977	Hiltebrandt	5,423,810	A	6/1995	Goble et al.
4,074,718	A	2/1978	Morrison, Jr.	5,425,739	A	6/1995	Jessen
4,088,134	A	5/1978	Mazzariello	5,429,616	A	7/1995	Schaffer
4,165,746	A	8/1979	Burgin	5,431,674	A	7/1995	Basile et al.
4,300,564	A	11/1981	Furihata	5,437,292	A	8/1995	Kipshidze et al.
4,370,980	A	2/1983	Lottick	5,438,302	A	8/1995	Goble
4,416,276	A	11/1983	Newton et al.	5,441,517	A	8/1995	Kensey et al.
4,452,246	A	6/1984	Bader et al.	5,443,463	A	8/1995	Stern et al.
4,492,231	A	1/1985	Auth	5,443,464	A	8/1995	Russell et al.
4,552,143	A	11/1985	Lottick	5,443,480	A	8/1995	Jacobs et al.
4,574,804	A	3/1986	Kurwa	5,443,483	A	8/1995	Stern et al.
4,597,379	A	7/1986	Kihn et al.	5,445,638	A	8/1995	Rydell et al.
4,600,007	A	7/1986	Lahodny et al.	5,445,658	A	8/1995	Durrfeld et al.
4,657,016	A	4/1987	Garito et al.	5,451,224	A	9/1995	Goble et al.
4,662,372	A	5/1987	Sharkany et al.	5,456,684	A	10/1995	Schmidt et al.
4,671,274	A	6/1987	Sorochenko	5,458,598	A	10/1995	Feinberg et al.
4,685,459	A	8/1987	Xoch et al.	5,460,629	A	10/1995	Shlain et al.
D295,893	S	5/1988	Sharkany et al.	5,462,546	A	10/1995	Rydell
D295,894	S	5/1988	Sharkany et al.	5,472,443	A	12/1995	Cordis et al.
4,763,669	A	8/1988	Jaeger	5,478,351	A	12/1995	Meade et al.
4,827,929	A	5/1989	Hodge	5,480,409	A	1/1996	Riza
4,887,612	A	12/1989	Esser et al.	5,484,436	A	1/1996	Eggers et al.
4,938,761	A	7/1990	Ensslin	5,496,317	A	3/1996	Goble et al.
4,985,030	A	1/1991	Melzer et al.	5,496,347	A	3/1996	Hashiguchi et al.
5,007,908	A	4/1991	Rydell	5,499,997	A	3/1996	Sharpe et al.
5,026,370	A	6/1991	Lottick	5,509,922	A	4/1996	Aranyi et al.
5,099,840	A	3/1992	Goble et al.	5,514,134	A	5/1996	Rydell et al.
5,116,332	A	5/1992	Lottick	5,527,313	A	6/1996	Scott et al.
5,147,357	A	9/1992	Rose et al.	5,531,744	A	7/1996	Nardella et al.
5,151,102	A	9/1992	Xamiyama et al.	5,536,251	A	7/1996	Evard et al.
5,176,695	A	1/1993	Dulebohn	5,540,684	A	7/1996	Hassler, Jr.
5,190,541	A	3/1993	Abele et al.	5,540,685	A	7/1996	Parins et al.
5,197,964	A	3/1993	Parins	5,540,715	A	7/1996	Katsaros et al.
5,215,101	A	6/1993	Jacobs et al.	5,558,672	A	9/1996	Edwards et al.
5,217,457	A	6/1993	Delahuerga et al.	5,562,699	A	10/1996	Heimberger et al.
5,217,458	A	6/1993	Parins	5,569,241	A	10/1996	Edwards
5,244,462	A	9/1993	Delahuerga et al.	5,569,243	A	10/1996	Kortenbach et al.
5,250,047	A	10/1993	Rydell	5,571,100	A	11/1996	Goble et al.
5,258,006	A	11/1993	Rydell et al.	5,573,424	A	11/1996	Poppe
5,261,918	A	11/1993	Phillips et al.	5,573,534	A	11/1996	Stone
5,275,615	A	1/1994	Rose	5,573,535	A	11/1996	Viklund
5,277,201	A	1/1994	Stern	5,582,611	A	12/1996	Tsukagoshi et al.
5,282,799	A	2/1994	Rydell	5,585,896	A	12/1996	Yamazaki et al.
5,290,286	A	3/1994	Parins	5,590,570	A	1/1997	LeMaire, III et al.
5,304,203	A	4/1994	El-Mallawany et al.	5,603,711	A	2/1997	Parins et al.
5,308,357	A	5/1994	Lichtman	5,603,723	A	2/1997	Aranyi et al.
5,318,589	A	6/1994	Lichtman	5,626,578	A	5/1997	Tihon
5,324,289	A	6/1994	Eggers	5,626,609	A	5/1997	Zvenyatsky et al.
5,330,471	A	7/1994	Eggers	5,630,833	A	5/1997	Katsaros et al.
5,334,183	A	8/1994	Wuchinich	5,637,110	A	6/1997	Pennybacker et al.
				5,643,294	A	7/1997	Tovey et al.

US D541,938 S

5,647,869 A	7/1997	Goble et al.	6,053,933 A	4/2000	Balazs et al.
5,647,871 A	7/1997	Levine et al.	D424,694 S	5/2000	Tetzlaff et al.
5,649,959 A	7/1997	Hannam et al.	D425,201 S	5/2000	Tetzlaff et al.
5,658,281 A	8/1997	Heard	RE36,795 E	7/2000	Rydell
5,662,667 A	9/1997	Knodel	6,083,223 A	7/2000	Baker
5,667,526 A	9/1997	Levin	6,086,586 A	7/2000	Hooven
5,674,220 A	10/1997	Fox et al.	6,090,107 A	7/2000	Borgmeier et al.
5,681,282 A	10/1997	Eggers et al.	6,096,037 A	8/2000	Mulier et al.
5,693,051 A	12/1997	Schulze et al.	6,099,550 A	8/2000	Yoon
5,695,522 A	12/1997	LeMaire, III et al.	6,102,909 A	8/2000	Chen et al.
5,700,261 A	12/1997	Brinkerhoff	6,110,171 A	8/2000	Rydell
5,702,390 A	12/1997	Austin et al.	6,113,596 A	9/2000	Hooven et al.
5,707,369 A	1/1998	Vaitekunas et al.	6,113,598 A	9/2000	Baker
5,709,680 A	1/1998	Yates et al.	6,117,158 A	9/2000	Measamer et al.
5,716,366 A	2/1998	Yates	H1904 H	10/2000	Yates et al.
5,720,744 A	2/1998	Eggleston et al.	6,126,658 A	10/2000	Baker
5,727,428 A	3/1998	LeMaire, III et al.	6,152,923 A	11/2000	Ryan
5,735,848 A	4/1998	Yates et al.	6,174,309 B1	1/2001	Wrublewski et al.
5,743,906 A	4/1998	Parins et al.	6,179,834 B1	1/2001	Buysse et al.
5,755,717 A	5/1998	Yates et al.	6,179,837 B1	1/2001	Hooven
5,766,130 A	6/1998	Selmonosky	6,183,467 B1	2/2001	Shapeton et al.
5,766,166 A	6/1998	Hooven	6,187,003 B1	2/2001	Buysse et al.
5,766,170 A	6/1998	Eggers	6,190,386 B1	2/2001	Rydell
5,769,849 A	6/1998	Eggers	6,193,718 B1	2/2001	Kortenbach et al.
5,776,128 A	7/1998	Eggers	6,206,877 B1	3/2001	Kese et al.
5,776,130 A	7/1998	Buysse et al.	6,224,593 B1	5/2001	Ryan et al.
5,779,701 A	7/1998	McBrayer et al.	6,228,080 B1	5/2001	Gines
5,792,137 A	8/1998	Carr et al.	6,228,083 B1	5/2001	Lands et al.
5,792,177 A	8/1998	Kaseda	6,267,761 B1	7/2001	Ryan
5,797,938 A	8/1998	Paraschac et al.	6,270,497 B1	8/2001	Sekino et al.
5,797,958 A	8/1998	Yoon	6,270,508 B1	8/2001	Klieman et al.
5,800,449 A	9/1998	Wales	6,273,887 B1	8/2001	Yamauchi et al.
5,810,808 A	9/1998	Eggers	6,277,117 B1	8/2001	Tetzlaff et al.
5,810,811 A	9/1998	Yates et al.	6,280,458 B1	8/2001	Boche et al.
5,810,877 A	9/1998	Roth et al.	6,283,961 B1	9/2001	Underwood et al.
5,814,043 A	9/1998	Shapeton	D449,886 S	10/2001	Tetzlaff et al.
5,817,093 A	10/1998	Williamson, IV et al.	6,322,561 B1	11/2001	Eggers et al.
5,820,630 A	10/1998	Lind	6,334,860 B1	1/2002	Dorn
5,827,271 A	10/1998	Buysse et al.	6,334,861 B1	1/2002	Chandler et al.
5,827,279 A	10/1998	Hughett et al.	6,350,264 B1	2/2002	Hooven
5,827,281 A	10/1998	Levin	6,352,536 B1	3/2002	Buysse et al.
5,833,690 A	11/1998	Yates et al.	D457,958 S	5/2002	Dycus et al.
5,843,080 A	12/1998	Fleenor et al.	D457,959 S	5/2002	Tetzlaff et al.
5,849,022 A	12/1998	Sakashita et al.	6,398,779 B1	6/2002	Buysse et al.
5,853,412 A	12/1998	Mayenberger	6,402,747 B1	6/2002	Lindemann et al.
5,876,401 A	3/1999	Schulze et al.	6,409,728 B1	6/2002	Ehr et al.
5,891,141 A	4/1999	Rydell	H2037 H	7/2002	Yates et al.
5,891,142 A	4/1999	Eggers et al.	6,419,675 B1	7/2002	Gallo, Sr.
5,893,863 A	4/1999	Yoon	6,425,896 B1	7/2002	Baltschun et al.
5,893,875 A	4/1999	O'Connor et al.	6,440,144 B1	8/2002	Bacher
5,893,877 A	4/1999	Gampp, Jr. et al.	6,443,970 B1	9/2002	Schulze et al.
5,902,301 A	5/1999	Olig	6,451,018 B1	9/2002	Lands et al.
5,906,630 A	5/1999	Anderhub et al.	6,458,128 B1	10/2002	Schulze
5,908,420 A	6/1999	Parins et al.	6,458,130 B1	10/2002	Frazier et al.
5,913,874 A	6/1999	Berns et al.	6,464,702 B2	10/2002	Schulze et al.
5,921,984 A	7/1999	Sutcu et al.	6,464,704 B2	10/2002	Schmaltz et al.
5,935,126 A	8/1999	Riza	6,511,480 B1	1/2003	Tetzlaff et al.
5,944,718 A	8/1999	Dafforn et al.	6,585,735 B1	7/2003	Frazier et al.
5,951,549 A	9/1999	Richardson et al.	6,620,161 B2	9/2003	Schulze et al.
5,954,720 A	9/1999	Wilson et al.	6,626,901 B1	9/2003	Treat et al.
5,976,132 A	11/1999	Morris	6,682,528 B2	1/2004	Frazier et al.
5,989,277 A	11/1999	LeMaire, III et al.	6,685,724 B1	2/2004	Haluck
6,004,335 A	12/1999	Vaitekunas et al.	6,695,840 B2	2/2004	Schulze
6,010,516 A	1/2000	Hulka et al.	6,726,686 B2	4/2004	Buysse et al.
6,024,741 A	2/2000	Williamson et al.	6,733,498 B2	5/2004	Paton et al.
6,024,744 A	2/2000	Kese et al.	6,743,229 B2	6/2004	Buysse et al.
6,033,399 A	3/2000	Gines	D496,997 S	10/2004	Dycus et al.
6,039,733 A	3/2000	Buysse et al.	D499,181 S	11/2004	Dycus et al.
6,041,679 A	3/2000	Slater et al.	6,926,716 B2	8/2005	Baker et al.
6,050,996 A	4/2000	Schmaltz et al.	6,929,644 B2	8/2005	Truckai et al.
6,053,914 A	4/2000	Eggers et al.	2002/0107517 A1	8/2002	Witt et al.

2002/0188294	A1	12/2002	Couture et al.	JP	501068	9/1984
2003/0014052	A1	1/2003	Buyse et al.	JP	40112	2/1993
2003/0014053	A1	1/2003	Nguyen et al.	JP	5-40112	2/1993
2003/0018331	A1	1/2003	Dycus et al.	JP	06343644	A2 12/1994
2003/0018332	A1	1/2003	Schmaltz et al.	JP	08343644	A2 12/1994
2003/0032956	A1	2/2003	Lands et al.	JP	07265328	A2 10/1995
2003/0069571	A1	4/2003	Treat et al.	JP	08056955	A2 3/1996
2003/0078578	A1	4/2003	Truckai Csaba et al.	JP	08252263	A2 10/1996
2003/0109875	A1	6/2003	Tetzlaff et al.	JP	09010223	A2 1/1997
2003/0139741	A1	7/2003	Goble et al.	JP	11244298	A2 9/1999
2003/0139742	A1	7/2003	Wampler et al.	JP	2000342599	A2 12/2000
2003/0158549	A1	8/2003	Swanson	JP	2000350732	A2 12/2000
2003/0181910	A1	9/2003	Dycus et al.	JP	2001008944	A2 1/2001
2003/0199869	A1	10/2003	Johnson et al.	JP	2001029356	A2 2/2001
2003/0229344	A1	12/2003	Dycus et al.	JP	2001128990	A2 5/2001
2004/0082952	A1	4/2004	Dycus et al.	RU	401367	11/1974
2004/0087943	A1	5/2004	Dycus et al.	SU	401367	10/1973
2004/0115296	A1	6/2004	Duffin	WO	WO 92/06842	4/1992
2004/0116924	A1	6/2004	Dycus et al.	WO	WO 94/08524	A 4/1994
2004/0122423	A1	6/2004	Dycus et al.	WO	WO 95/02369	1/1995
2004/0143263	A1	7/2004	Schechter et al.	WO	WO 95/07662	3/1995
2004/0147925	A1	7/2004	Buyse et al.	WO	WO 96/13218	9/1996
2004/0162557	A1	8/2004	Tetzlaff et al.	WO	WO 97/00646	1/1997
2004/0176762	A1	9/2004	Lawes et al.	WO	WO 97/00647	1/1997
2004/0225288	A1	11/2004	Buyse et al.	WO	WO 97/10764	3/1997
2004/0236325	A1	11/2004	Tetzlaff et al.	WO	WO 97/24073	7/1997
2004/0243125	A1	12/2004	Dycus et al.	WO	WO 97/24993	7/1997
2004/0249371	A1	12/2004	Dycus et al.	WO	WO 98/27880	7/1998
2004/0249374	A1	12/2004	Tetzlaff et al.	WO	WO 99/03407	1/1999
2004/0250419	A1	12/2004	Sremcich et al.	WO	WO 99/03408	1/1999
2004/0254573	A1	12/2004	Dycus et al.	WO	WO 99/03409	1/1999
2005/0004568	A1	1/2005	Lawes et al.	WO	WO 99/12488	A 3/1999
2005/0004570	A1	1/2005	Chapman et al.	WO	WO 99/40857	8/1999
2005/0021025	A1	1/2005	Buyse et al.	WO	WO 99/51158	10/1999
2005/0021026	A1	1/2005	Bally	WO	WO 99/66850	A 12/1999
2005/0021027	A1	1/2005	Shields et al.	WO	WO 00/24330	5/2000
2005/0101951	A1	5/2005	Wham et al.	WO	WO 00/24331	5/2000
2005/0113818	A1	5/2005	Sartor et al.	WO	WO 00/41638	7/2000
				WO	WO 00/53112	9/2000
				WO	WO 01/17448	A 3/2001
				WO	WO 01/54604	8/2001
				WO	WO 02/07627	1/2002
				WO	WO 02/080783	10/2002
				WO	WO 02/080784	10/2002
				WO	WO 02/080785	10/2002
				WO	WO 02/080786	10/2002
				WO	WO 02/080793	10/2002
				WO	WO 02/080794	10/2002
				WO	WO 02/080795	10/2002
				WO	WO 02/080796	A1 10/2002
				WO	WO 02/080797	10/2002
				WO	WO 02/080798	10/2002
				WO	WO 02/080799	10/2002
				WO	WO 02/081170	10/2002
				WO	WO 04/032777	4/2004
				WO	WO 2004/052221	A1 6/2004
				WO	WO 04/073490	9/2004
				WO	WO 2004/082495	A1 9/2004
				WO	WO 2004/098383	A1 11/2004
				WO	WO 04/103156	12/2004

FOREIGN PATENT DOCUMENTS

DE	29616210	1/1997
DE	19608716	4/1997
DE	19751108	5/1999
EP	0364216	A1 4/1990
EP	518230	A1 12/1992
EP	0 541 930	B1 5/1993
EP	0572131	12/1993
EP	584787	A1 3/1994
EP	0623316	A1 11/1994
EP	0624348	A2 11/1994
EP	0650701	A1 5/1995
EP	0694290	A3 3/1996
EP	0717966	A1 6/1996
EP	0754437	A3 3/1997
EP	853922	A1 7/1998
EP	0887046	A3 1/1999
EP	0923907	A1 6/1999
EP	1034747	A1 9/2000
EP	1034748	A1 9/2000
EP	1025807	A3 10/2000
EP	1034746	A3 10/2000
EP	1050278	A1 11/2000
EP	1053719	A1 11/2000
EP	1053720	A1 11/2000
EP	1055399	A1 11/2000
EP	1055400	A1 11/2000
EP	1080694	A1 3/2001
EP	1082944	A1 3/2001
EP	1159926	A2 12/2001
GB	2214430	A 6/1989
JP	502328	3/1972

OTHER PUBLICATIONS

Kennedy et al. "High-burst-strength, feedback-controlled bipolar vessel sealing" *Surgical Endoscopy* (1998) 12: 876-878.

Peterson et al. "Comparison of Healing Process Following Ligation with Sutures and Bipolar Vessel Sealing" *Surgical Technology International* (2001).

Johnson et al. "Evaluation of the LigaSure Vessel Sealing System in Hemorrhoidectomy" *American College of Surgeons (ACS) Clinica Congress Poster* (2000).

- Sayfan et al. "Sutureless Closed Hemorrhoidectomy: A New Technique" *Annals of Surgery* vol. 234 No. 1 Jul. 2001. pp. 21–24.
- Heniford et al. "Initial Results with an Electrothermal Bipolar Vessel Sealer" *Surgical Endoscopy* (2000) 15:799–801.
- Heniford et al. "Initial Research and Clinical Results with an Electrothermal Bipolar Vessel Sealer" Oct. 1999.
- McLellan et al. "Vessel Sealing for Hemostasis During Pelvic Surgery" *Int'l Federation of Gynecology and Obstetrics FIGO World Congress 2000*, Washington, D.C.
- Levy et al. "Use of a New Energy-based Vessel Ligation Device During Vaginal Hysterectomy" *Int'l Federation of Gynecology and Obstetrics (FIGO) World Congress*.
- Crawford et al. "Use of the LigaSure Vessel Sealing System in Urologic Cancer Surger" *Grand Rounds in Urology* 1999 vol. 1 Issue 4 pp. 10–17.
- Rothenberg et al. "Use of the LigaSure Vessel Sealing System in Minimally Invasive Surgery in Children" *Int'l Pediatric Endosurgery Group (IPEG) 2000*.
- Palazzo et al. "Randomized clinical trial of Ligasure versus open haemorrhoidectomy" *British Journal of Surgery* 2002, 89, 154–157.
- "Innovations in Electrosurgery", Sales/Product Literature.
- LigaSure Vessel Sealing System, the Seal of Confidence in General, Gynecologic, Urologic, and Laparoscopic Surgery Sales/Product Literature.
- Carbonell et al., "Comparison of the GyruS PlasmaKinetic Sealer and the Valleylab LigaSure Device in the Hemostasis of Small, Medium, and Large-Sized Arteries", *Carolinas Laparoscopic and Advanced Surgery Program, Carolinas Medical Center, Charlotte, NC*.
- "Reducing Needlestick Injuries in the Operating Room", Sales/Product Literature.
- Chung et al., "Clinical Experience of Sutureless Closed Hemorrhoidectomy with LigaSure" *Diseases of the Colon & Rectum* vol. 46, No. 1 Jan. 2003.
- Strasberg et al., "Use of a Bipolar Vessel-Sealing Device for Parenchymal Transection During Liver Surgery" *Journal of Gastrointestinal Surgery*, vol. 6, No. 4, Jul./Aug. 2002 pp. 569–574.
- Paul G. Horgan, "A Novel Technique for Parenchymal Division During Hepatectomy" *The American Journal of Surgery*, vol. 181, No. 3, □Apr. 2001, pp. 236–237.
- W. Scott Helton, "LigaSure Vessel Sealing System: Revolutionary Hemostasis Product for General Surgery" Sales/Product Literature.
- Michael Choti, "Abdominoperineal Resection with the LigaSure Vessel Sealing System and LigaSure Atlas 20 cm Open Instrument" *Innovations That Work*, □Jun. 2003.
- Craig Johnson, "Use of the LigaSure Vessel Sealing System in Bloodless Hemorrhoidectomy" *Innovations That Work*, □Mar. 2000.
- Muller et al., "Extended Left Hemicolectomy Using the LigaSure Vessel Sealing System" *Innovations That Work*, □Sep. 1999.
- Herman et al., "Laparoscopic Intestinal Resection With the LigaSure Vessel Sealing System: A Case Report" *Innovations That Work*, □Feb. 2002.
- Carus et al., "Initial Experience With The LigaSure Vessel Sealing System in Abdominal Surgery" *Innovations That Work*, □Jun. 2002.
- Levy et al. "Randomized Trial of Suture Versus Electrosurgical Bipolar Vessel Sealing in Vaginal Hysterectomy" *Obstetrics & Gynecology*, vol. 102, No. 1, Jul. 2003.
- Levy et al., "Update on Hysterectomy—New Technologies and Techniques" *OBG Management*, Feb. 2003.
- Barbara Levy, "Use of a New Vessel Ligation Device During Vaginal Hysterectomy" *FIGO 2000*, Washington, D.C.
- McLellan et al. "Vessel Sealing for Hemostasis During Gynecologic Surgery" Sales/Product Literature.
- Sengupta et al., "Use of a Computer-Controlled Bipolar Diathermy System in Radical Prostatectomies and Other Open Urological Surgery" *ANZ Journal of Surgery* (2001) 71.9 pp. 538–540.
- Olsson et al. "Radical Cystectomy in Females", *Current Surgical Techniques in Urology*, vol. 14, Issue 3.
- E. David Crawford "Use of a Novel Vessel Sealing Technology in Management of the Dorsal Venous Complex" Sales/Product Literature.
- Jarrett et al., "Use of the LigaSure Vessel Sealing System for Peri-Hilar Vessels in Laparoscopic Nephrectomy" Sales/Product Literature.
- E. David Crawford "Evaluation of a New Vessel Sealing Device in Urologic Cancer Surgery" Sales/Product Literature.
- Joseph Ortenberg "LigaSure System Used in Laparoscopic 1st and 2nd Stage Orchiopexy" *Innovations That Work*, Nov. 2002.
- Koyle et al., "Laparoscopic Palomo Varicocele Ligation in Children and Adolescents" *Pediatric Endosurgery & Innovative Techniques*, vol. 6, No. 1, 2002.
- Dulemba et al. "Use of a Bipolar Electrothermal Vessel Sealer in Laparoscopically Assisted Vaginal Hysterectomy" Sales/Product Literature.
- Johnson et al. "Evaluation of a Bipolar electrothermal Vessel Sealing Device in Hemorrhoidectomy" Sales/Product Literature.
- Int'l Search Report PCT/US01/11218.
- Int'l Search Report PCT/US99/24869.
- Int'l Search Report PCT/US98/18640.
- Int'l Search Report PCT/US98/23950.
- PCT/US01/11340, International Search Report.
- PCT/US01/11420, International Search Report.
- PCT/US02/01890, International Search Report.
- PCT/US02/11100, International Search Report.
- PCT/US04/03436, International Search Report.
- PCT/US04/13273, International Search Report.
- PCT/US04/15311, International Search Report.
- EP 98944778, International Search Report.
- EP 98958575, International Search Report.
- EP 04027479, International Search Report.
- EP 04027705, International Search Report.
- EP 04027314, International Search Report.
- "Innovations in Electrosurgery" Sales/Product Literature; Dec. 31, 2000.
- LigaSure Vessel Sealing System, the Seal of Confidence in General, Gynecologic, Urologic, and Laparoscopic Surgery Sales/Product Literature; Jan., 2004.
- Olsson et al. "Radical Cystectomy in Females" *Current Surgical Techniques in Urology*, vol. 14, Issue 3, 2001.
- Dulemba et al. "Use of a Bipolar Electrothermal Seater in Laparoscopically Assisted Vaginal Hysterectomy" Sales Product Literature; Jan., 2004.
- Johnson et al. "Evaluation of a Bipolar electrothermal Vessel Sealing Device In Hemorrhoidectomy" Sales Product Literature; Jan., 2004.
- Linehan et al. "A Phase I Study of the LigaSure Vessel Sealing in Hepatic Surgery" *Section of HPB Surger, Washington University of Medicine, St. Louis MO, Presented at AHPBA*, Feb. 2001.

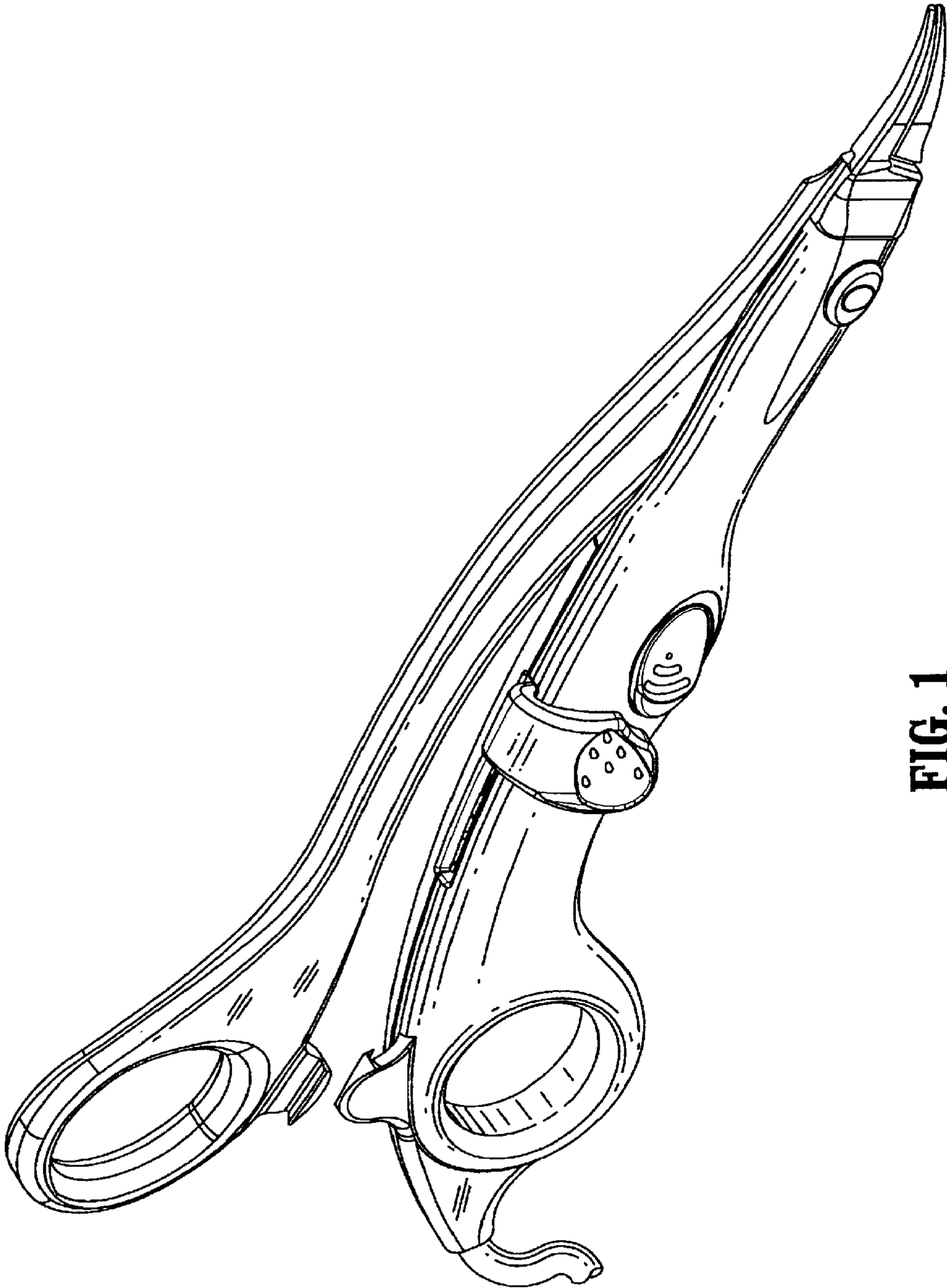

FIG. 1

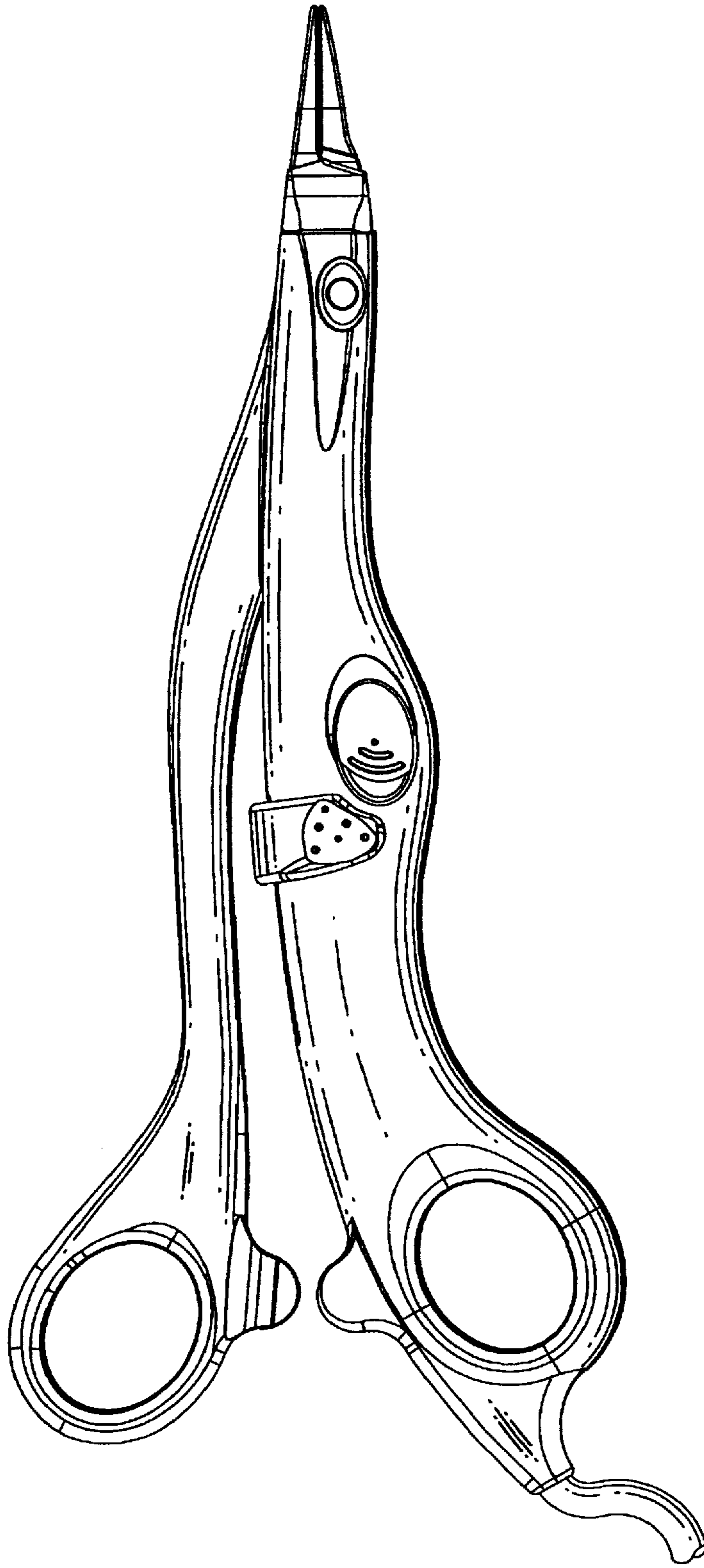

FIG. 2

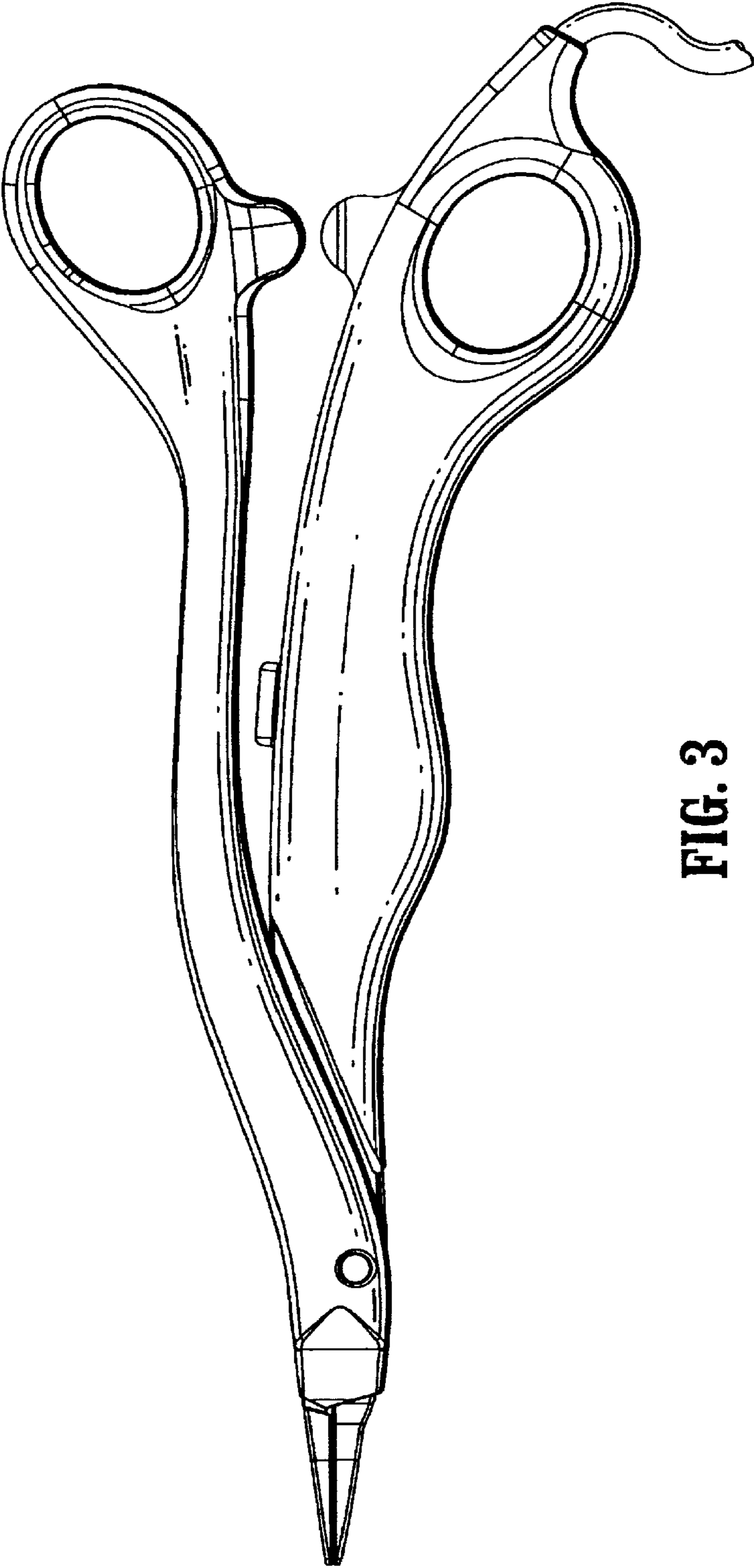

FIG. 3

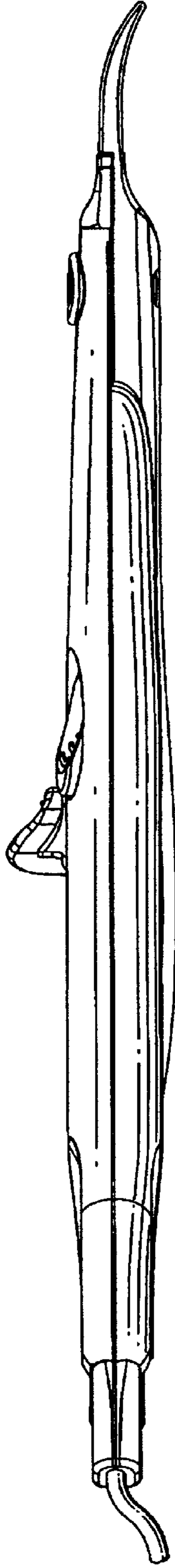

FIG. 4

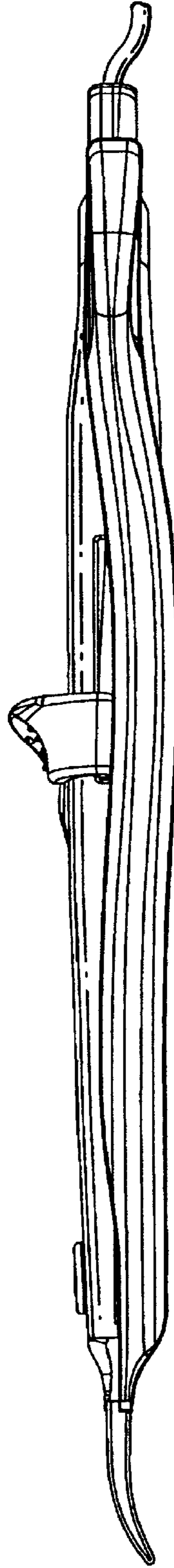

FIG. 5

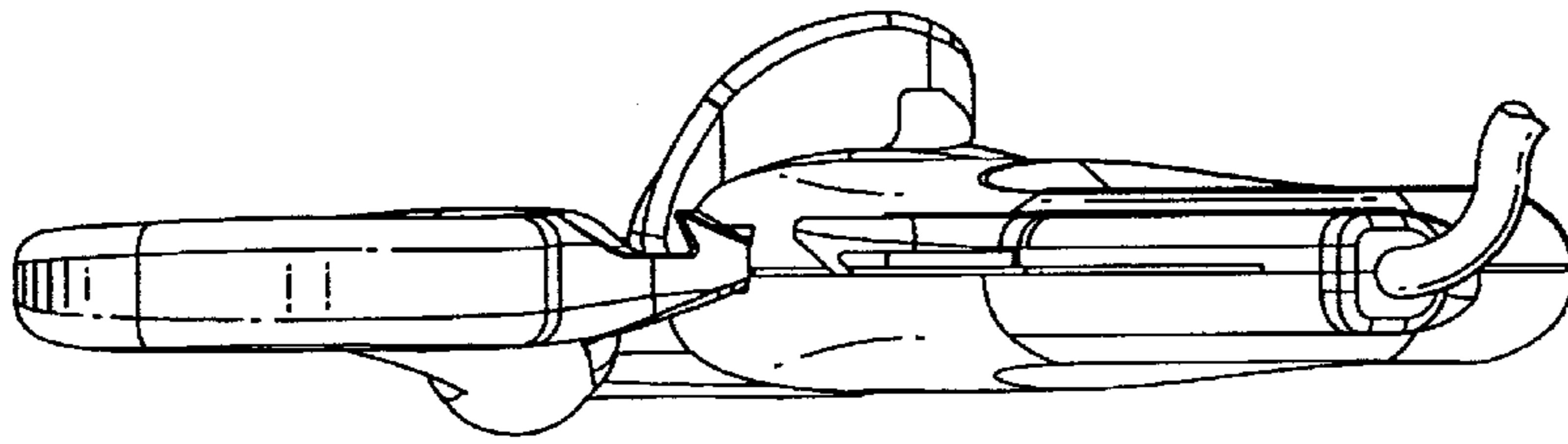

FIG. 7

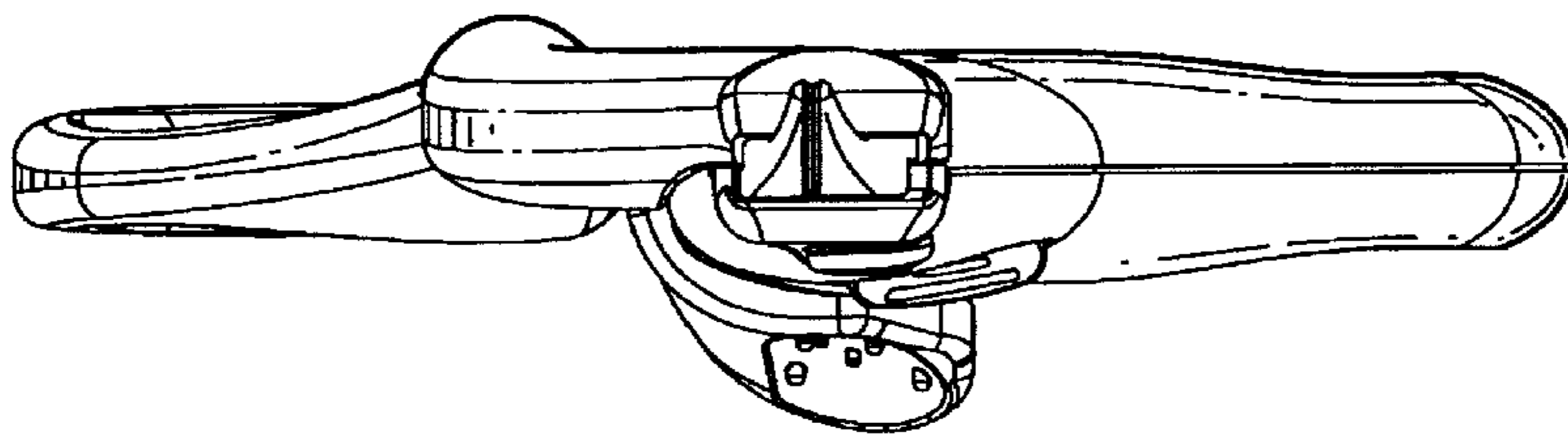

FIG. 6