

US00D541918S

(12) **United States Design Patent** (10) **Patent No.:** **US D541,918 S**
Bucher et al. (45) **Date of Patent:** **** May 1, 2007**

(54) **DECORATIVE FLOOR AND TABLE TOP HEATER**

(75) Inventors: **John C. Bucher**, Hillsboro Bch, FL (US); **William Ross Boswell**, Bentonville, AR (US); **Chad Ricker**, North Lauderdale, FL (US)

(73) Assignee: **King of Fans, Inc.**, Ft. Lauderdale, FL (US)

(**) Term: **14 Years**

(21) Appl. No.: **29/266,853**

(22) Filed: **Sep. 29, 2006**

Related U.S. Application Data

(62) Division of application No. 29/240,601, filed on Oct. 14, 2005.

(51) **LOC (8) Cl.** **23-03**

(52) **U.S. Cl.** **D23/335**

(58) **Field of Classification Search** D23/332, D23/314, 335-338, 340-345, 349-350; 392/360, 392/365-369, 373-376; 312/326; 126/110 B, 126/90 A, 92 A

See application file for complete search history.

(56) **References Cited**

U.S. PATENT DOCUMENTS

D322,669 S 12/1991 Yamamoto et al. D23/378
D329,284 S 9/1992 Patton D23/378

D423,093 S 4/2000 Fok et al. D23/378
D459,454 S * 6/2002 Shapiro D23/335
D462,429 S * 9/2002 Gao D23/335
D464,723 S 10/2002 Fok et al. D23/378
D479,874 S 9/2003 Shapiro D23/378
D499,472 S * 12/2004 Ching D23/332
D516,688 S * 3/2006 Blateri D23/335

* cited by examiner

Primary Examiner—Brian N Vinson

(74) *Attorney, Agent, or Firm*—Brian S. Steinberger; Law Offices of Brian S. Steinberger, P.A.

(57) **CLAIM**

The ornamental design for a decorative floor and table top heater, as shown and described.

DESCRIPTION

FIG. 1 is a fight front perspective view of the decorative floor and table top heater showing our new design; FIG. 2 is a left front perspective view thereof; FIG. 3 is a right rear perspective view thereof; FIG. 4 is a left rear perspective view thereof; FIG. 5 is a left side view thereof; FIG. 6 is a right side view thereof; FIG. 7 is a front view thereof; FIG. 8 is a rear view thereof; FIG. 9 is top perspective view thereof; and, FIG. 10 is a bottom view thereof.

The broken-line disclosure in the views is for illustrative purposes only and forms no part of the claimed design.

1 Claim, 10 Drawing Sheets

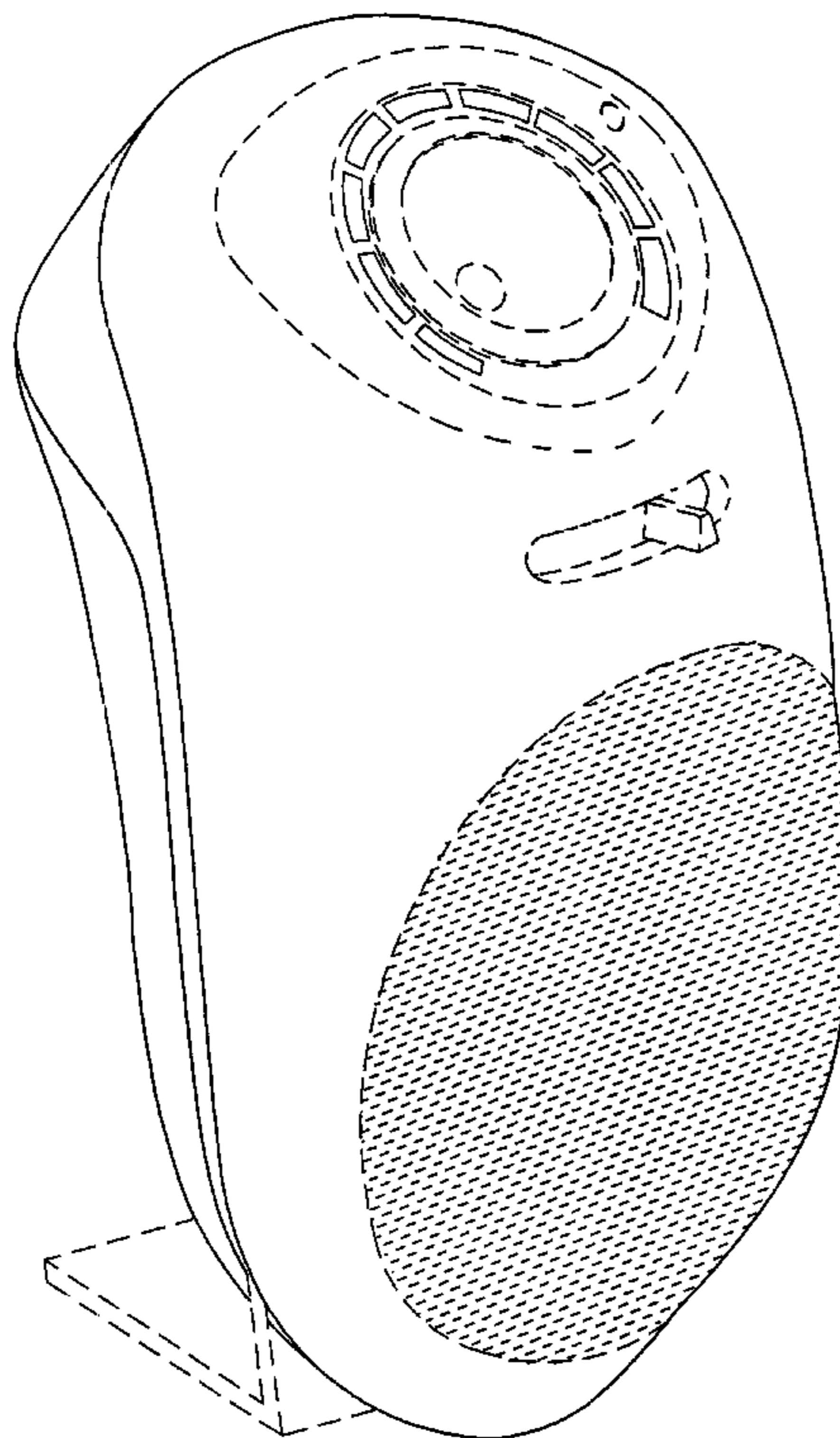

Fig. 1

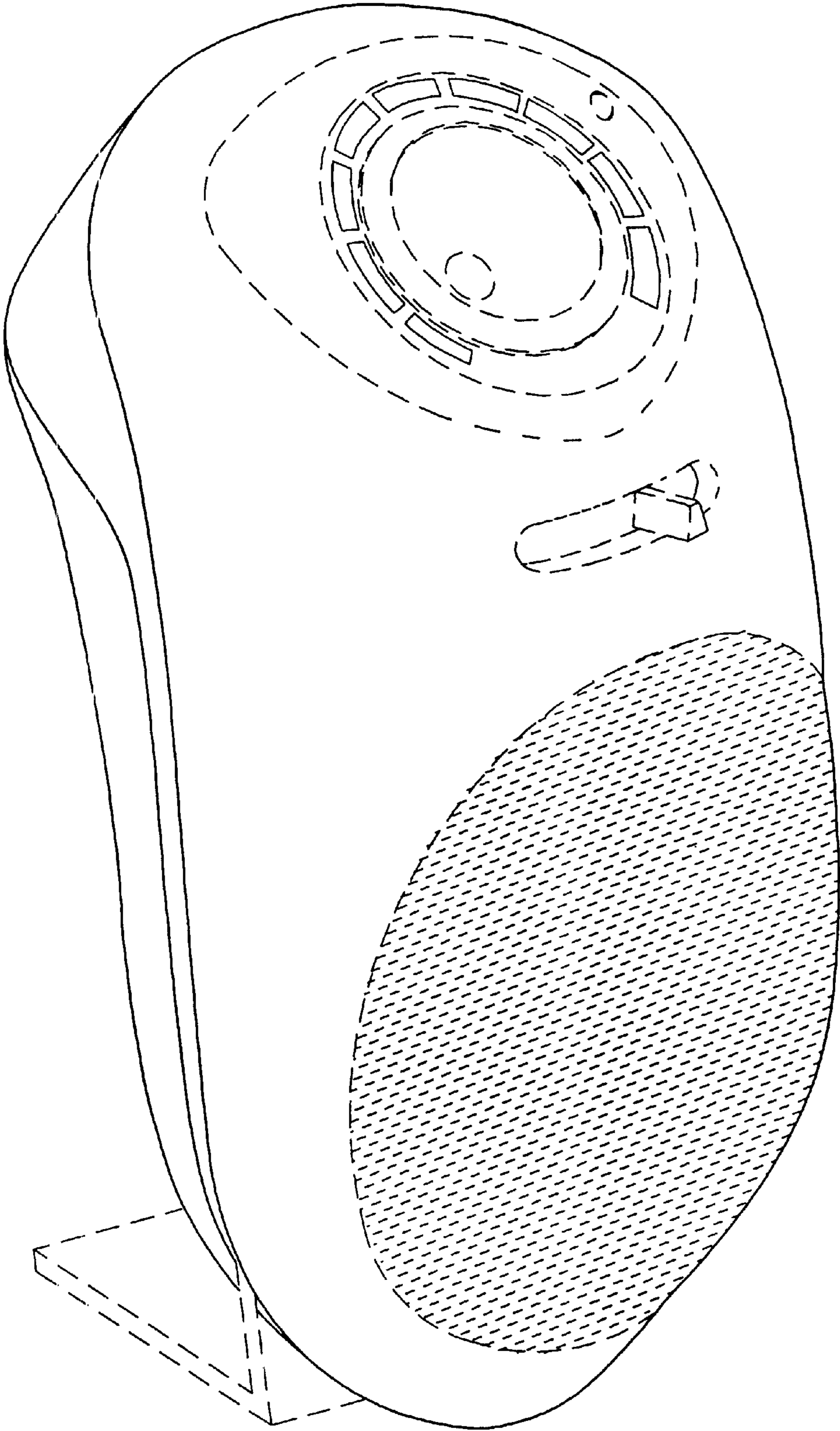

Fig. 2

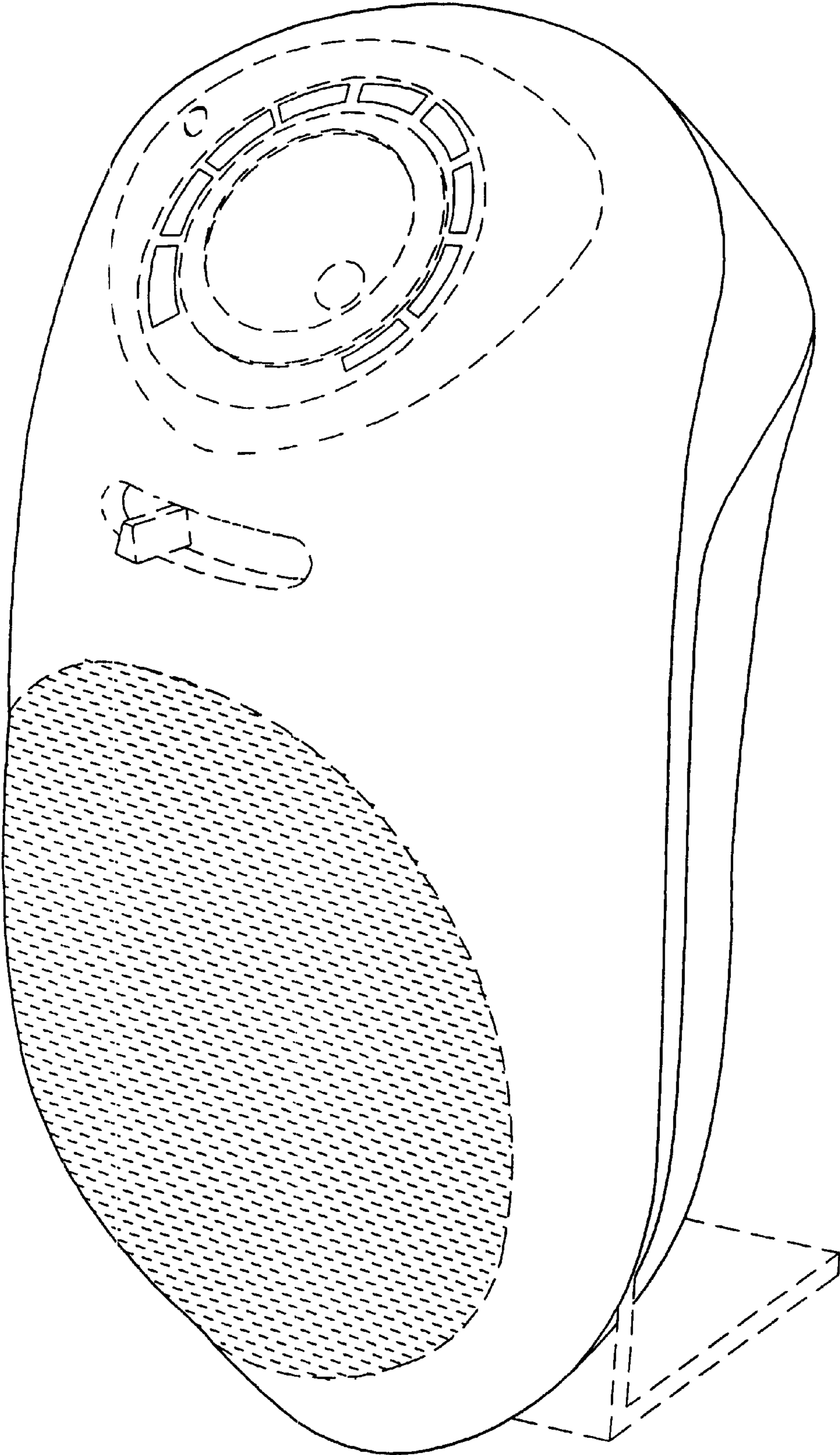

Fig. 3

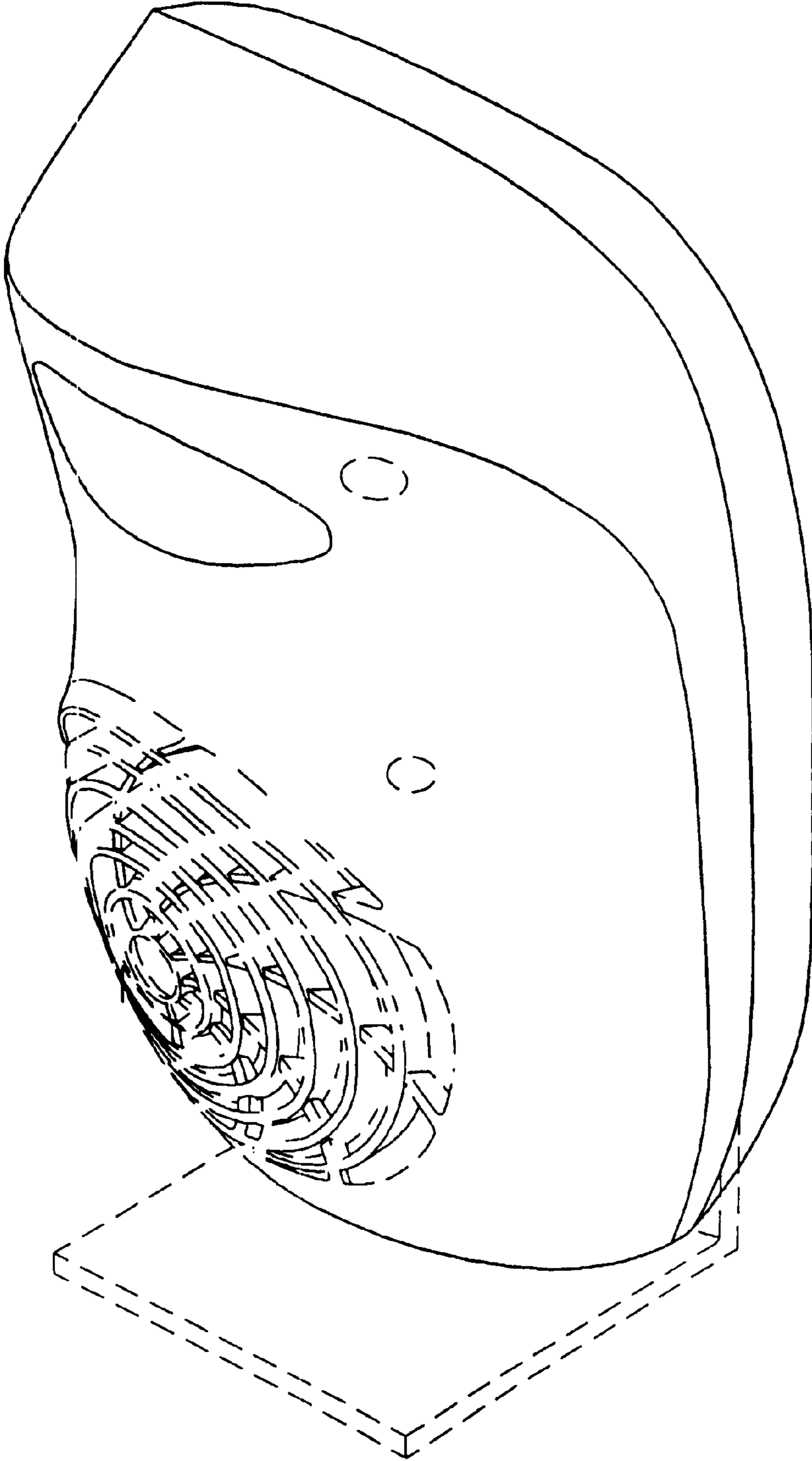

Fig. 4

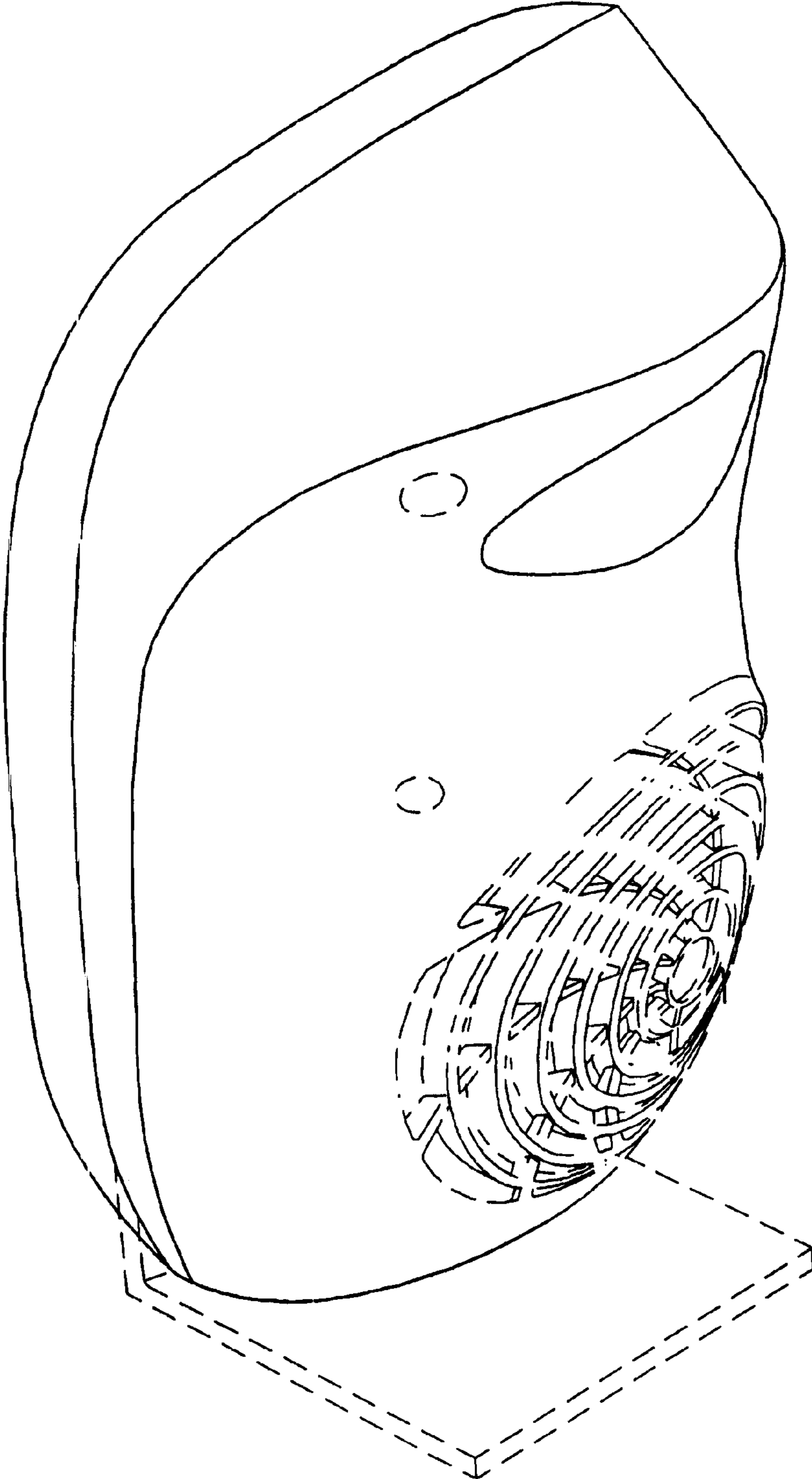

Fig. 5

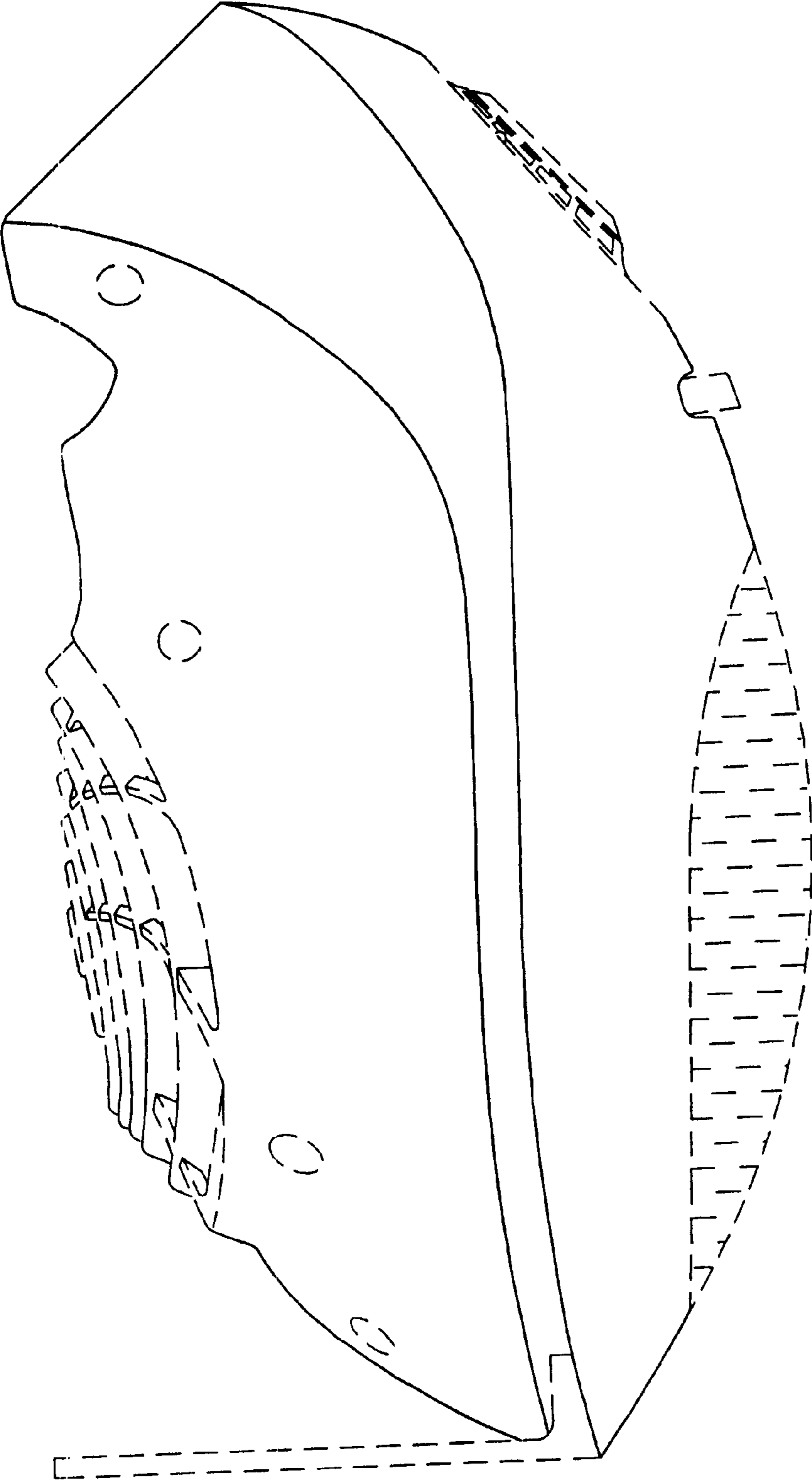

Fig. 6

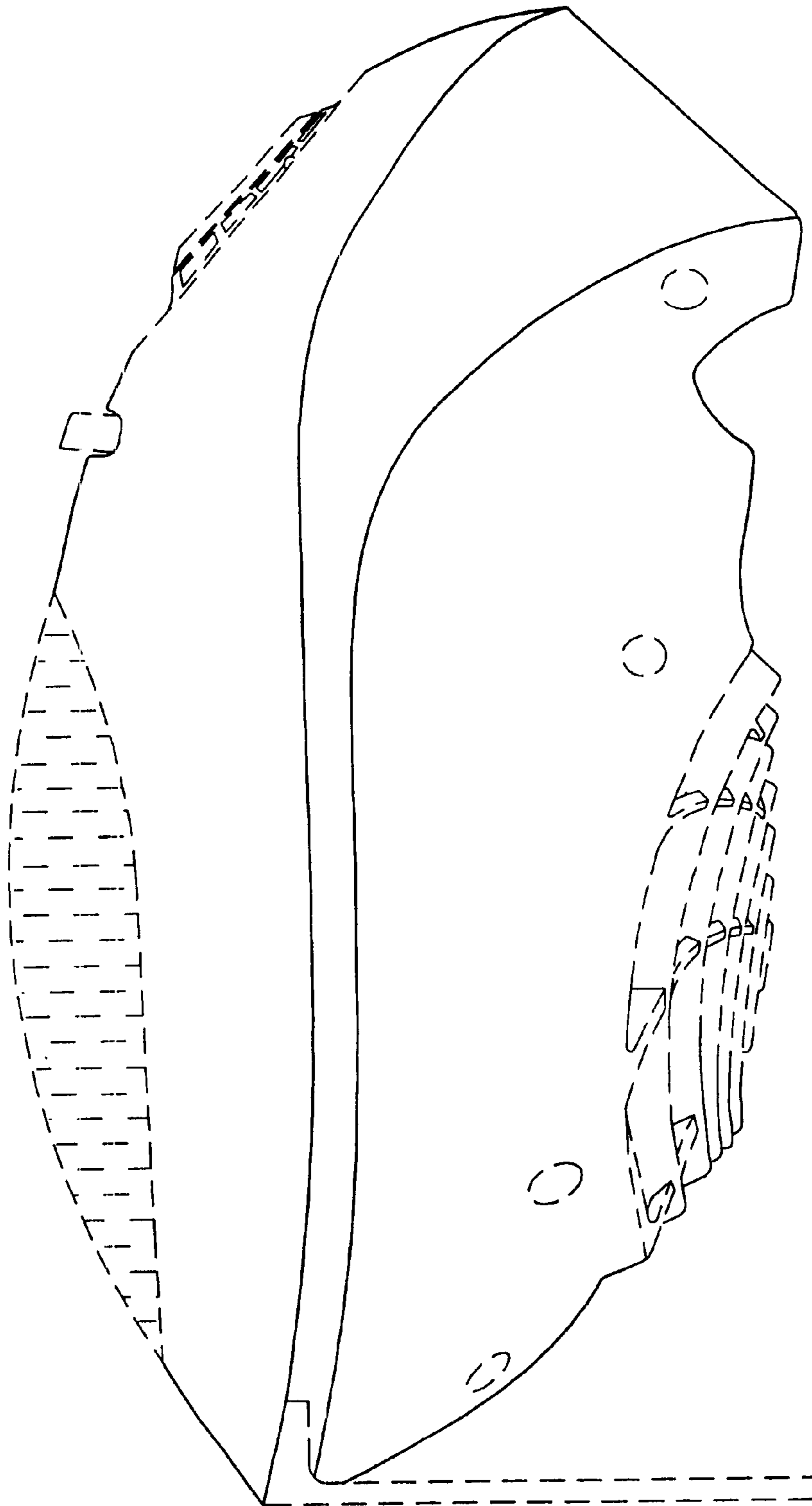

Fig. 7

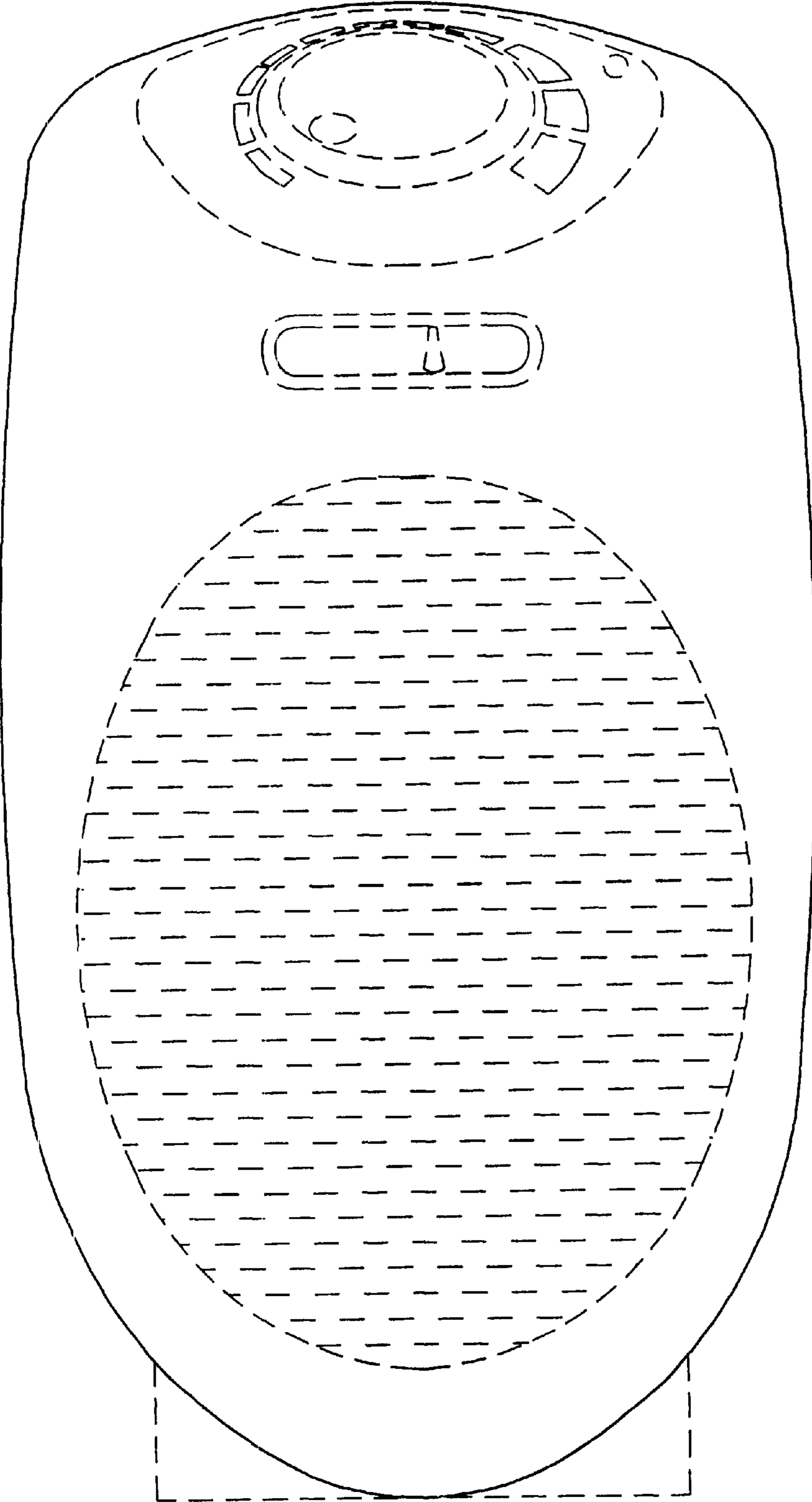

Fig. 8

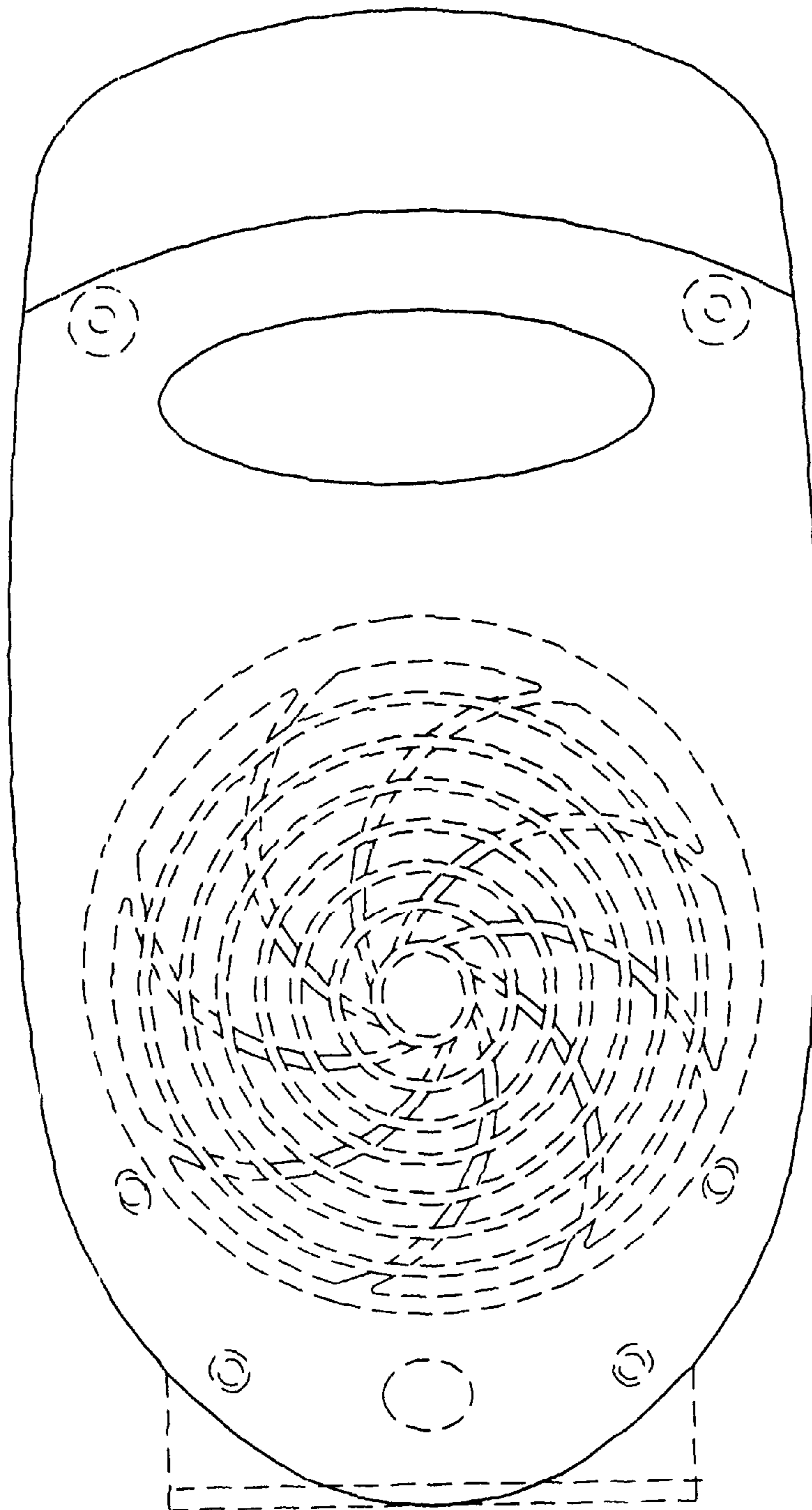

Fig. 9

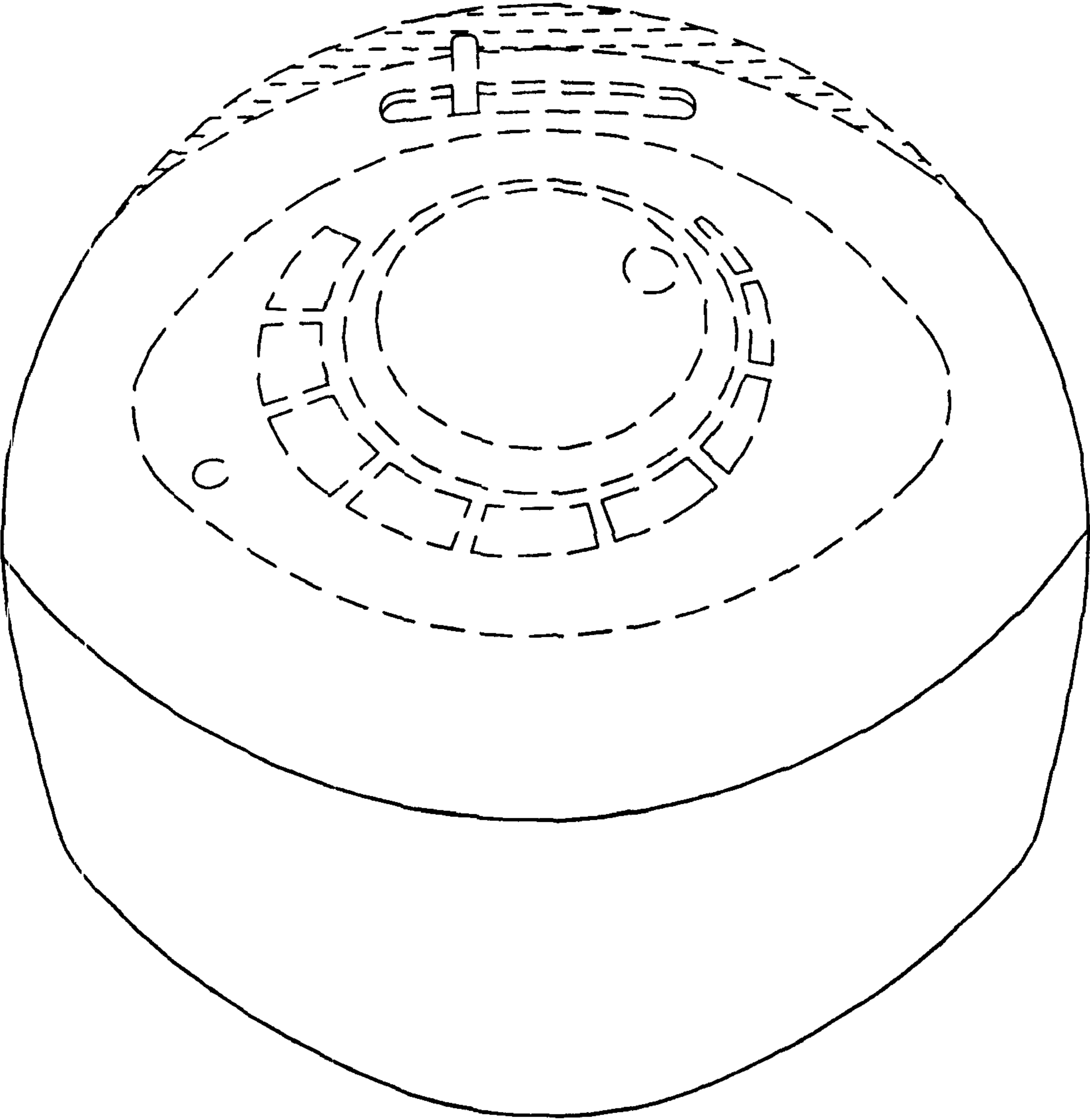

Fig. 10

