

US00D541827S

(12) **United States Design Patent**
Resch

(10) **Patent No.:** **US D541,827 S**

(45) **Date of Patent:** **** May 1, 2007**

(54) **REFRIGERATION MACHINERY AND APPARATUS**

(75) Inventor: **Reinhold Resch**, Rottenmann (AT)

(73) Assignee: **AHT Cooling Systems GmbH**, Rottenmann (AT)

(**) Term: **14 Years**

(21) Appl. No.: **29/261,637**

(22) Filed: **Jun. 16, 2006**

(30) **Foreign Application Priority Data**

Dec. 16, 2005 (EM) 000449491-0001/0003

(51) **LOC (8) Cl.** **15-07**

(52) **U.S. Cl.** **D15/83**

(58) **Field of Classification Search** D15/79,
D15/81-85; D6/396, 397, 470-472; 62/3.6,
62/125, 126; 312/116, 138.1, 236, 405, 406
See application file for complete search history.

(56) **References Cited**

U.S. PATENT DOCUMENTS

- D430,173 S * 8/2000 Tombs D15/85
- D439,913 S * 4/2001 Jobst D15/84
- D449,845 S * 10/2001 Reese et al. D15/83
- D477,616 S * 7/2003 Resch D15/83
- D477,617 S * 7/2003 Resch D15/83

- D483,045 S * 12/2003 Resch D15/83
- D520,529 S * 5/2006 Resch D15/83
- D520,530 S * 5/2006 Resch D15/83
- D521,029 S * 5/2006 Resch D15/83
- D521,535 S * 5/2006 Resch D15/83
- D524,330 S * 7/2006 Pedersen et al. D15/81
- D524,831 S * 7/2006 Resch D15/83
- D530,346 S * 10/2006 Resch D15/83

* cited by examiner

Primary Examiner—Stella Reid

Assistant Examiner—Shanda C. Hill

(74) *Attorney, Agent, or Firm*—Collard & Roe, P.C.

(57) **CLAIM**

The ornamental design for a refrigeration machinery and apparatus, as shown and described.

DESCRIPTION

FIG. 1 shows a top perspective view of my design for a refrigeration machinery and apparatus;
 FIG. 2 shows a side view thereof;
 FIG. 3 shows an opposite side view thereof;
 FIG. 4 shows a rear view thereof;
 FIG. 5 shows a top view thereof;
 FIG. 6 shows a front view thereof; and,
 FIG. 7 shows a bottom view thereof.
 FIGS. 2 through 7 are shown on a reduced scale.

1 Claim, 7 Drawing Sheets

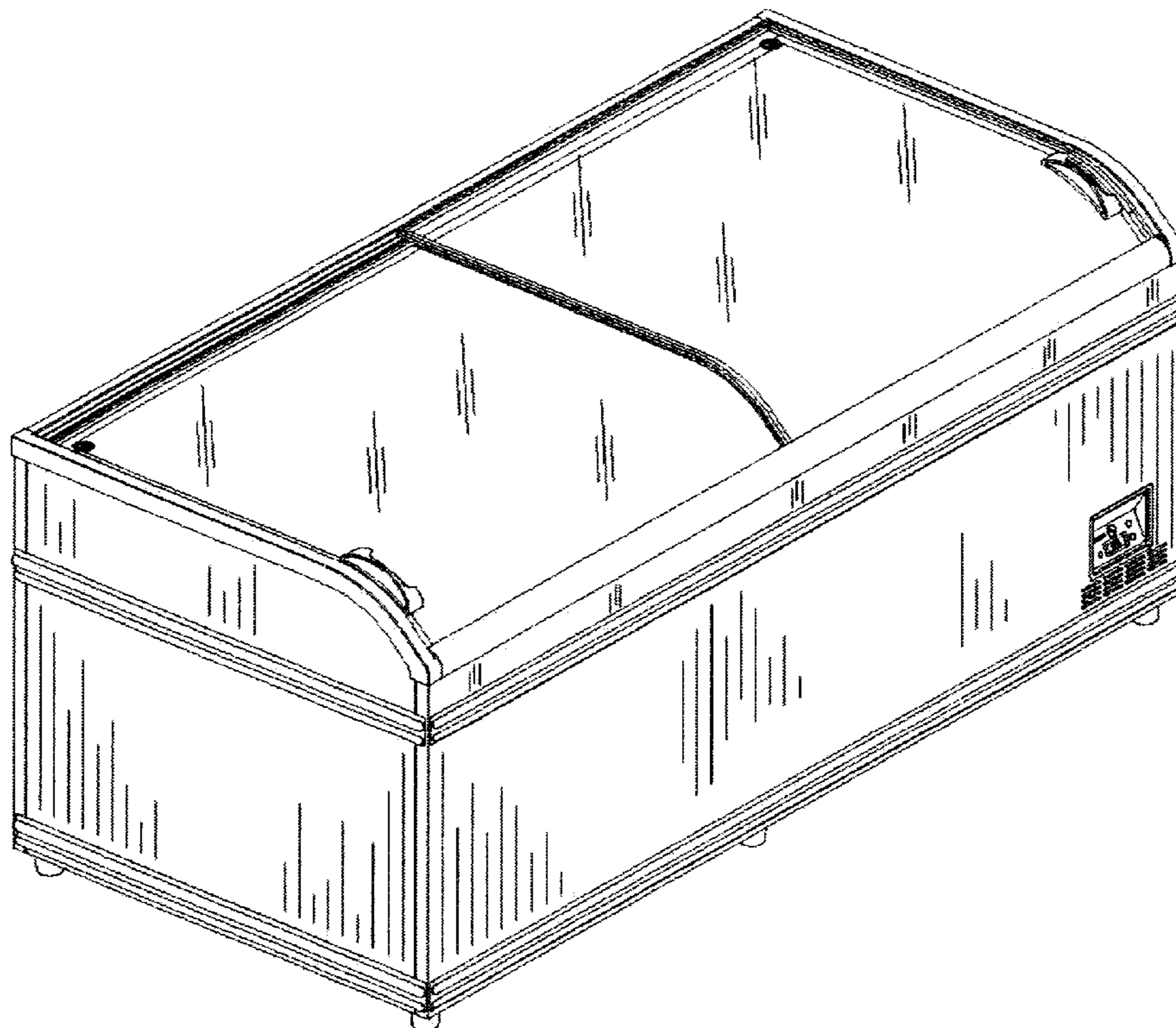

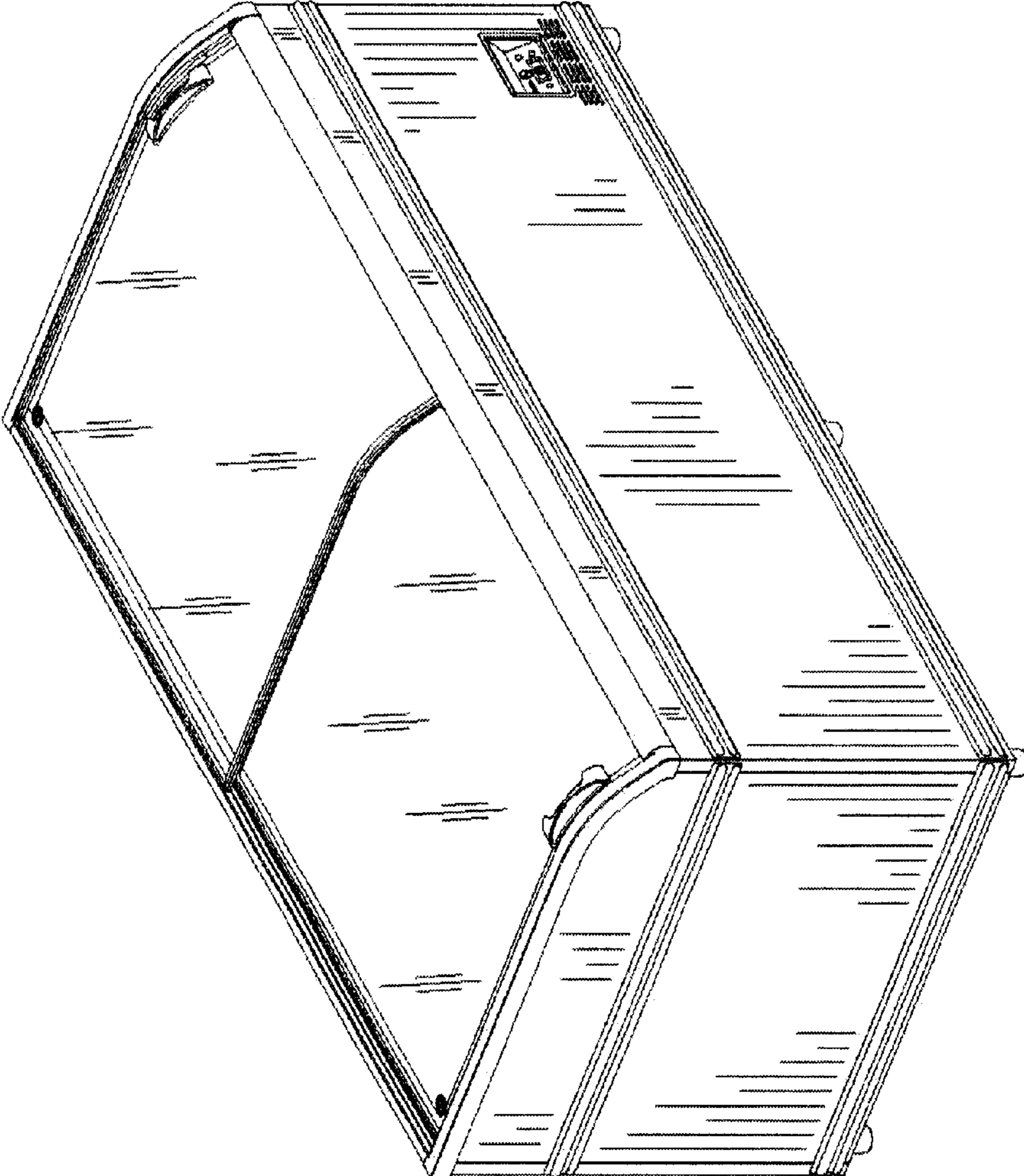

FIG.1

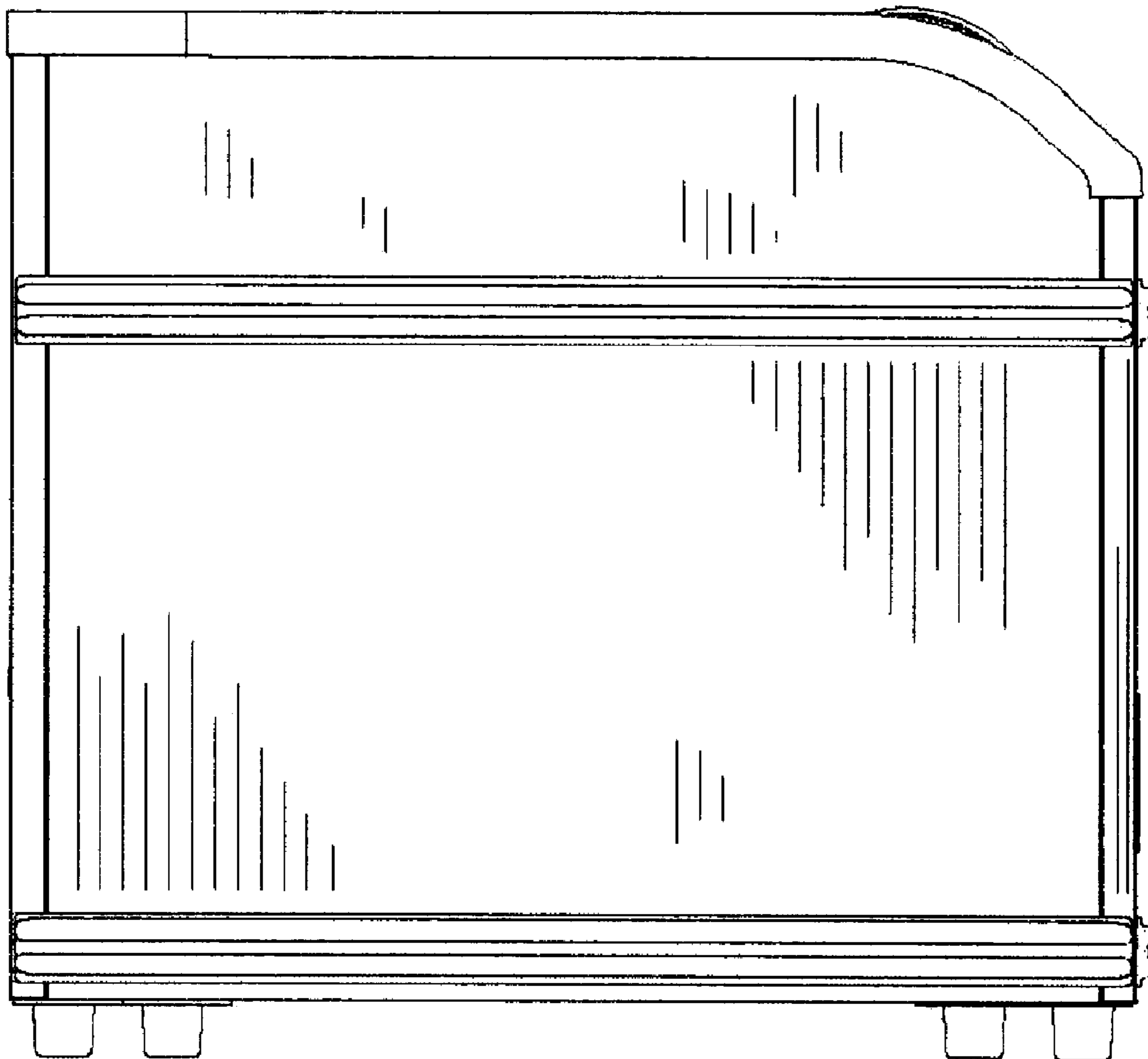

FIG. 2

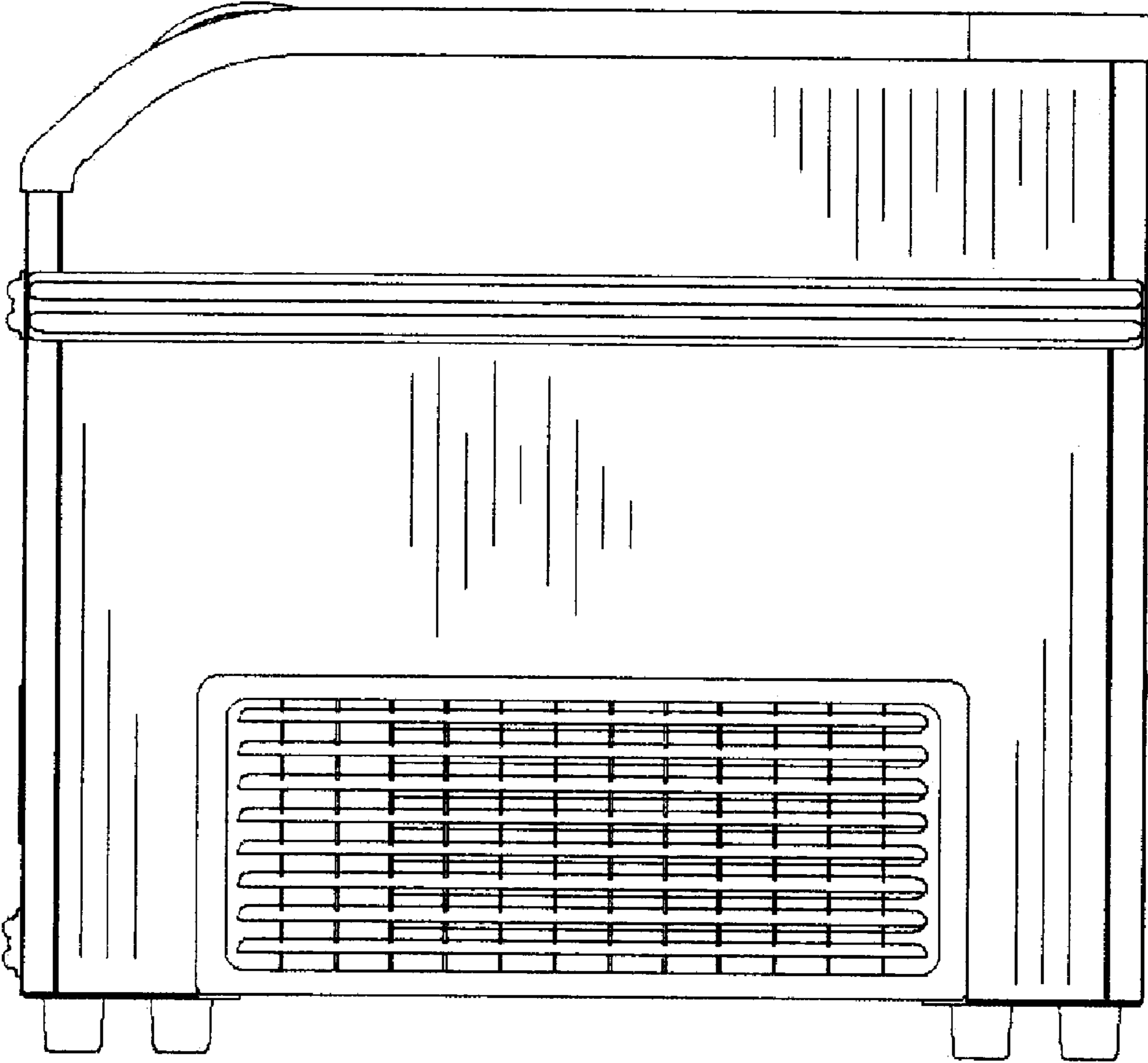

FIG. 3

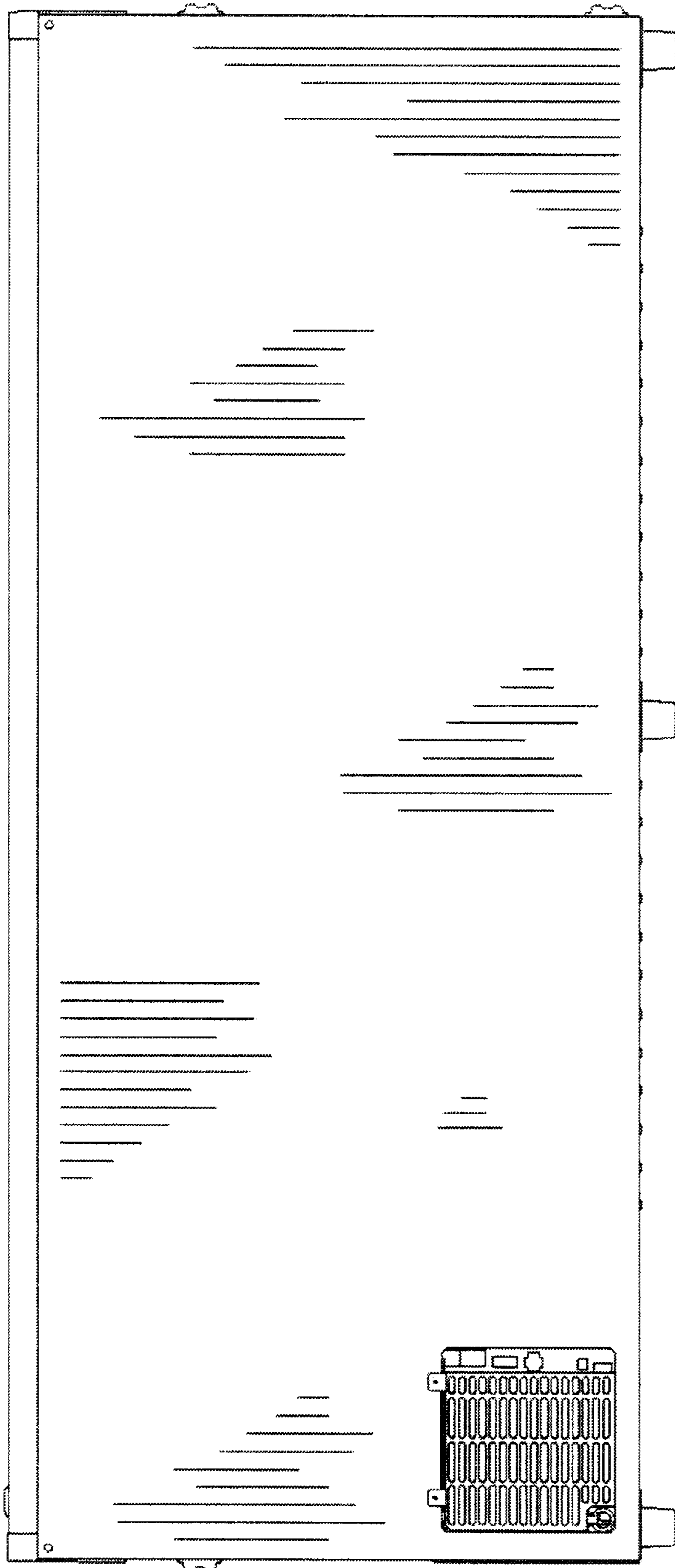

FIG. 4

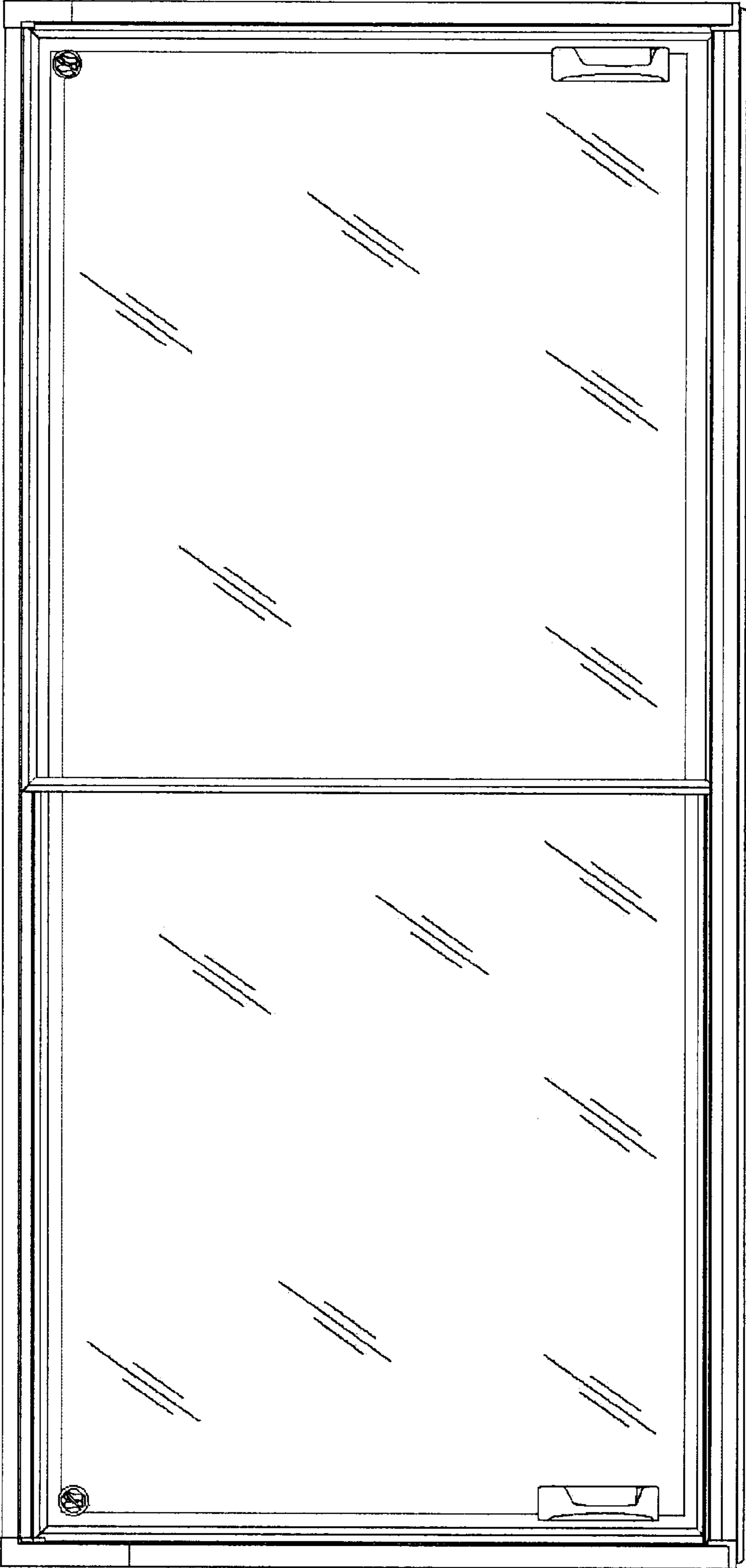

FIG. 5

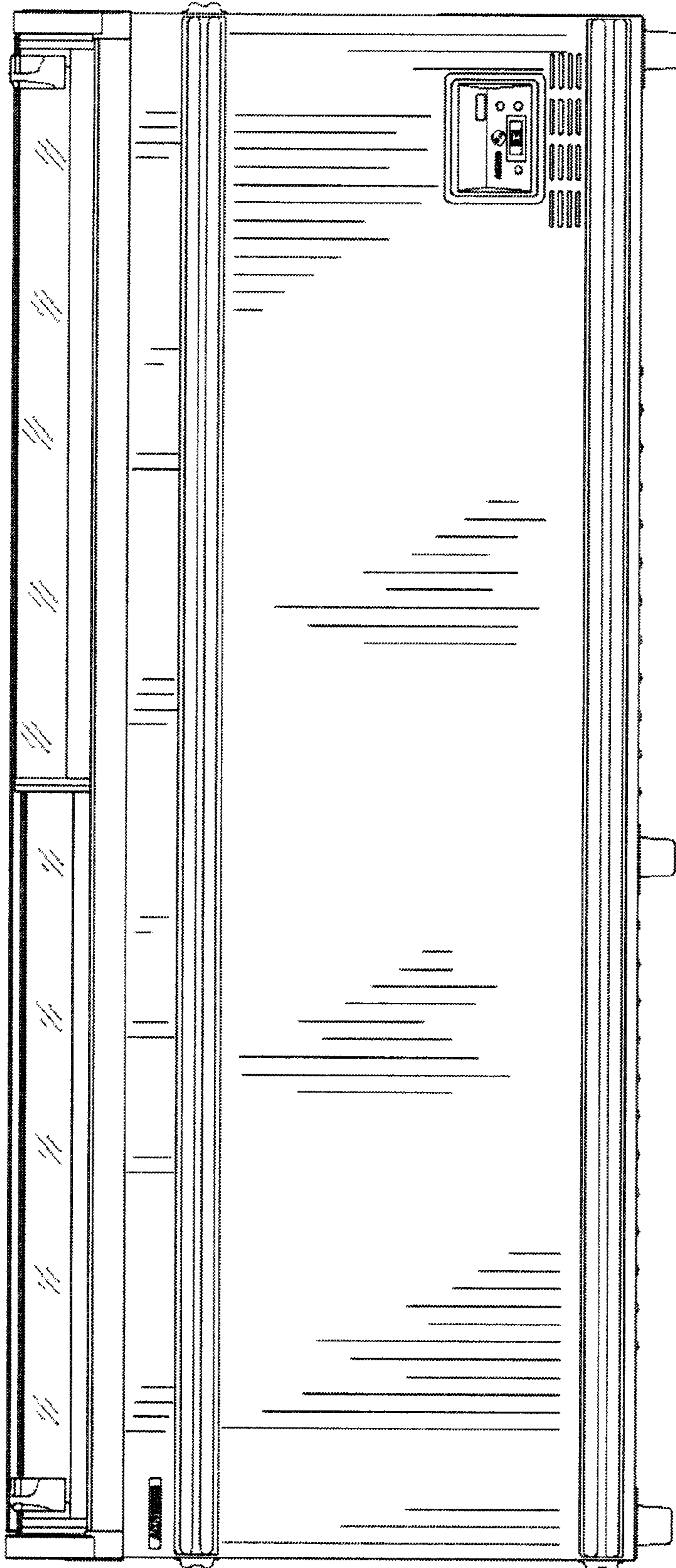

FIG. 6

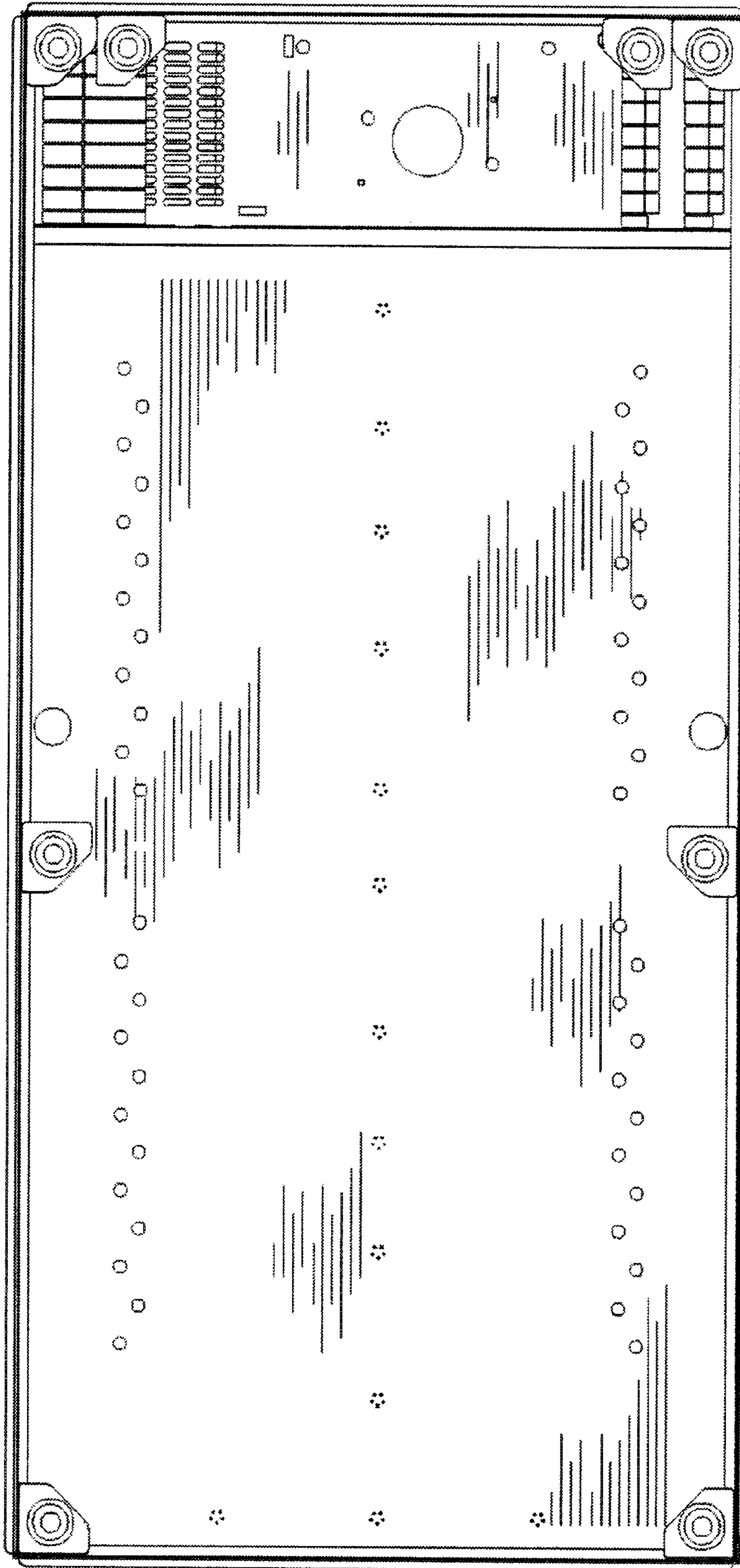

FIG. 7