



US00D541815S

(12) **United States Design Patent**
Drummond, Jr.

(10) **Patent No.:** **US D541,815 S**

(45) **Date of Patent:** **** May 1, 2007**

(54) **MATING HOUSING COMPONENTS FOR FORMING PUMP HOUSING**

(75) **Inventor:** **Robert E. Drummond, Jr.,**
Hillsborough, NH (US)

(73) **Assignee:** **Brailsford & Company, Inc.,** Antrim,
NH (US)

(**) **Term:** **14 Years**

(21) **Appl. No.:** **29/235,433**

(22) **Filed:** **Aug. 2, 2005**

(51) **LOC (8) Cl.** **15-02**

(52) **U.S. Cl.** **D15/7**

(58) **Field of Classification Search** D15/7-9;
D23/232, 231; 417/359, 415-416, 410.1,
417/321, 265, 405

See application file for complete search history.

(56) **References Cited**

U.S. PATENT DOCUMENTS

D352,721 S	*	11/1994	Cook et al.	D15/7
D444,795 S	*	7/2001	Wakasugi et al.	D15/7
D484,146 S	*	12/2003	Urano et al.	D15/7
D490,820 S	*	6/2004	Schoemneyr	D15/7
D492,325 S	*	6/2004	Niwatsukino et al.	D15/7
D517,091 S	*	3/2006	Sugiyama et al.	D15/7
D520,023 S	*	5/2006	Goto et al.	D15/7
D520,024 S	*	5/2006	Chen	D15/7

* cited by examiner

Primary Examiner—Ralf Seifert

(74) *Attorney, Agent, or Firm*—Davis Bujold & Daniels,
P.L.L.C.

(57) **CLAIM**

I claim the ornamental design for mating housing components for forming pump housing, as shown and described.

DESCRIPTION

FIG. 1 is a top, left, front perspective view of the mating housing components for forming pump housing embodying my new design;

FIG. 2 is a front elevational view thereof;

FIG. 3 is a left side elevational view thereof;

FIG. 4 is a right side elevational view thereof;

FIG. 5 is a top plan view thereof;

FIG. 6 is a bottom plan view thereof;

FIG. 7 is a rear elevational view thereof;

FIG. 8 is a top, left, front perspective view of the mating housing components for forming pump housing embodying my new design;

FIG. 9 is a front elevational view thereof;

FIG. 10 is a left side elevational view thereof;

FIG. 11 is a right side elevational view thereof;

FIG. 12 is a top plan view thereof;

FIG. 13 is a bottom plan view thereof;

FIG. 14 is a rear elevational view thereof;

FIG. 15 is a top, left, front perspective view of the mating housing components for forming pump housing embodying my new design;

FIG. 16 is a front elevational view thereof;

FIG. 17 is a left side elevational view thereof;

FIG. 18 is a right side elevational view thereof;

FIG. 19 is a top plan view thereof;

FIG. 20 is a bottom plan view thereof; and,

FIG. 21 is a rear elevational view thereof.

1 Claim, 3 Drawing Sheets

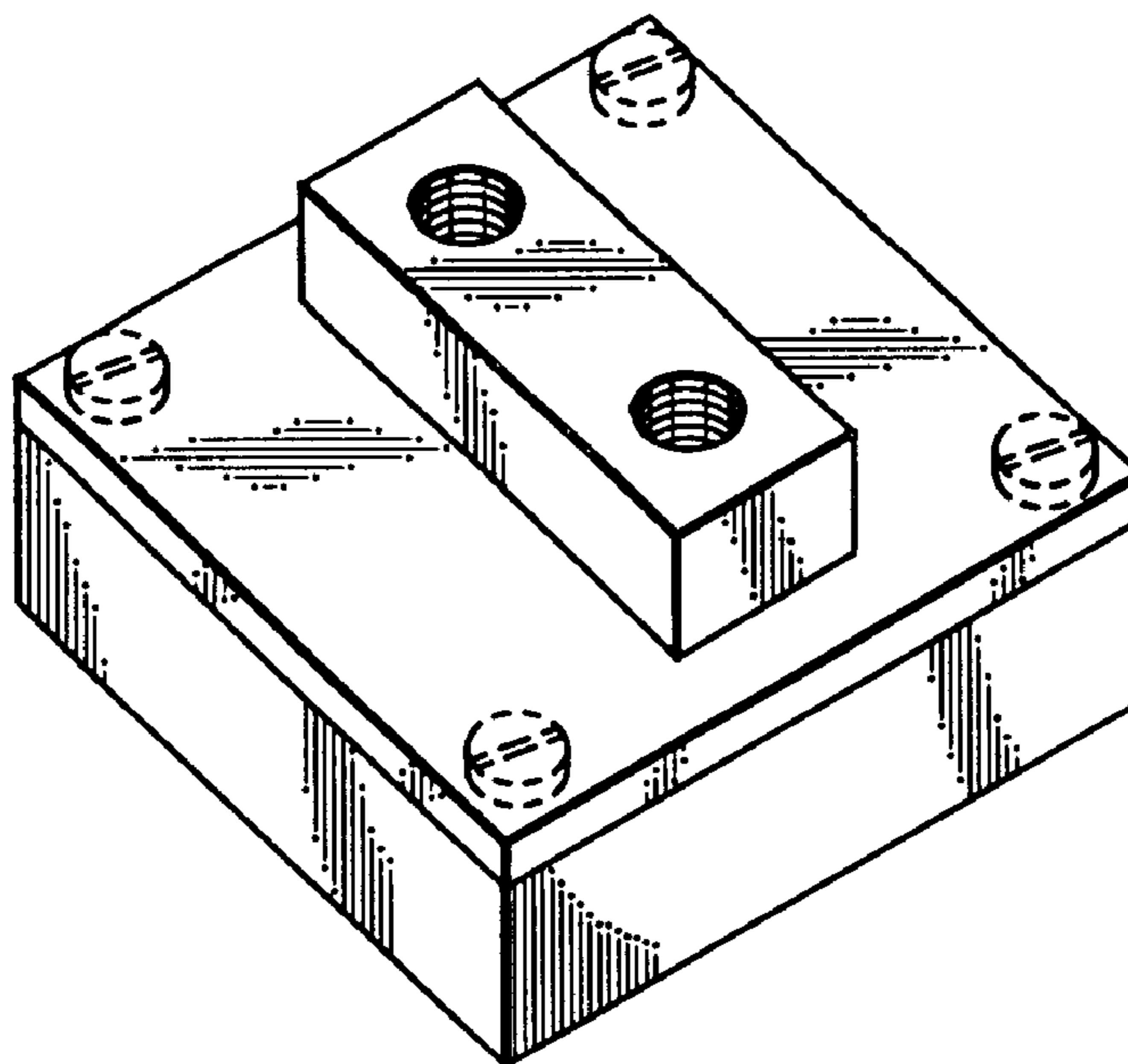

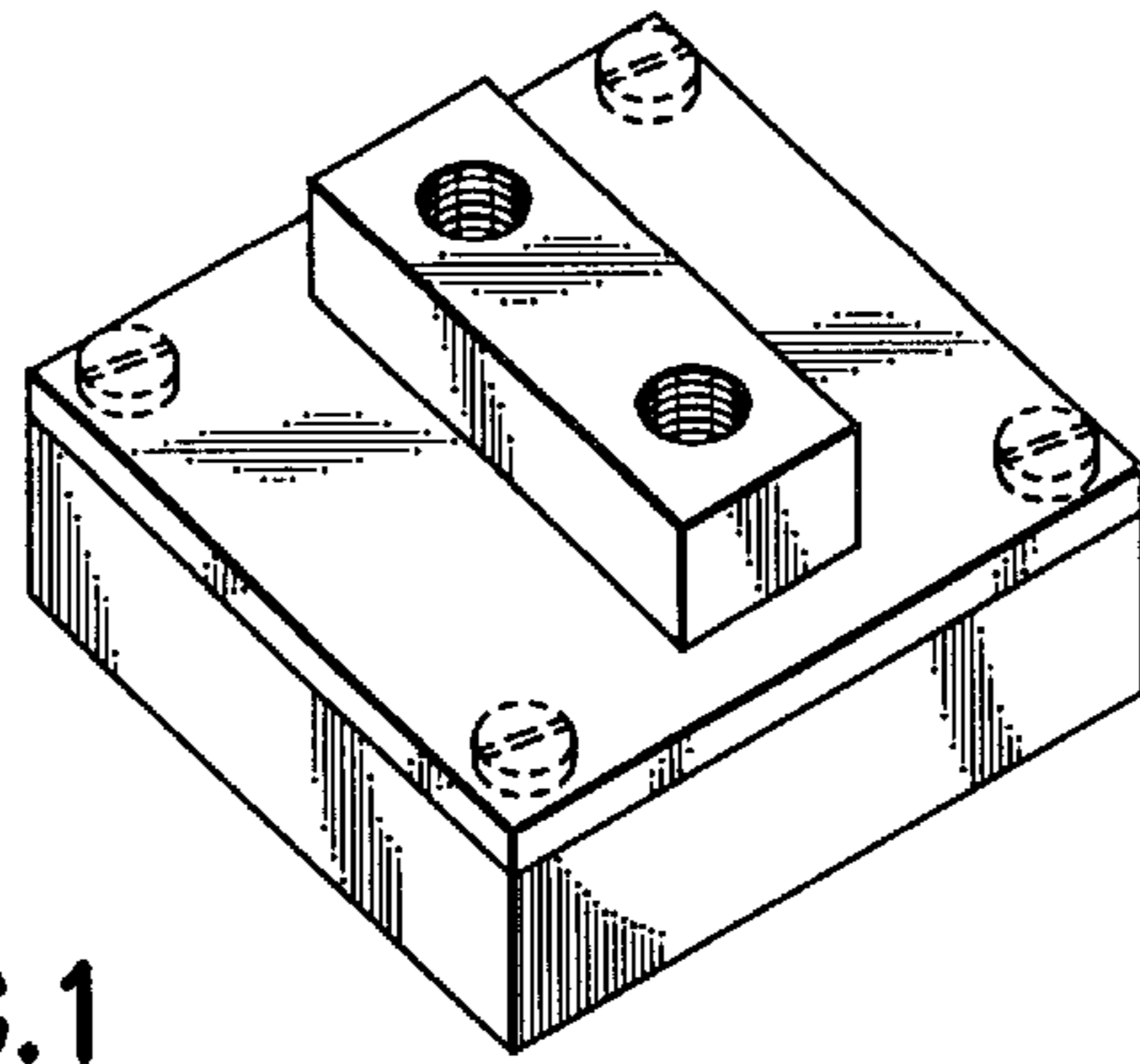

FIG.1

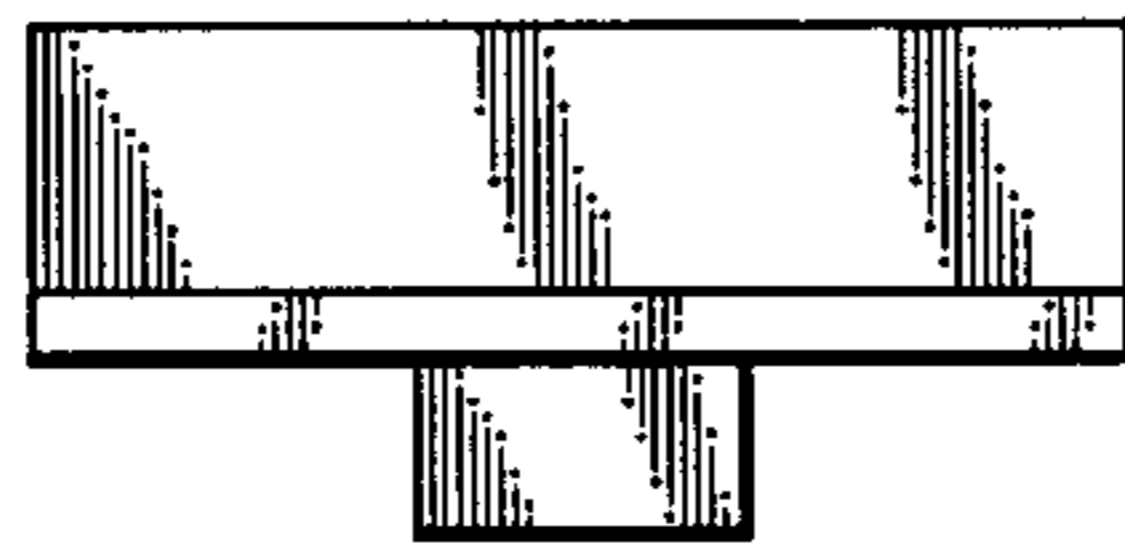

FIG.5

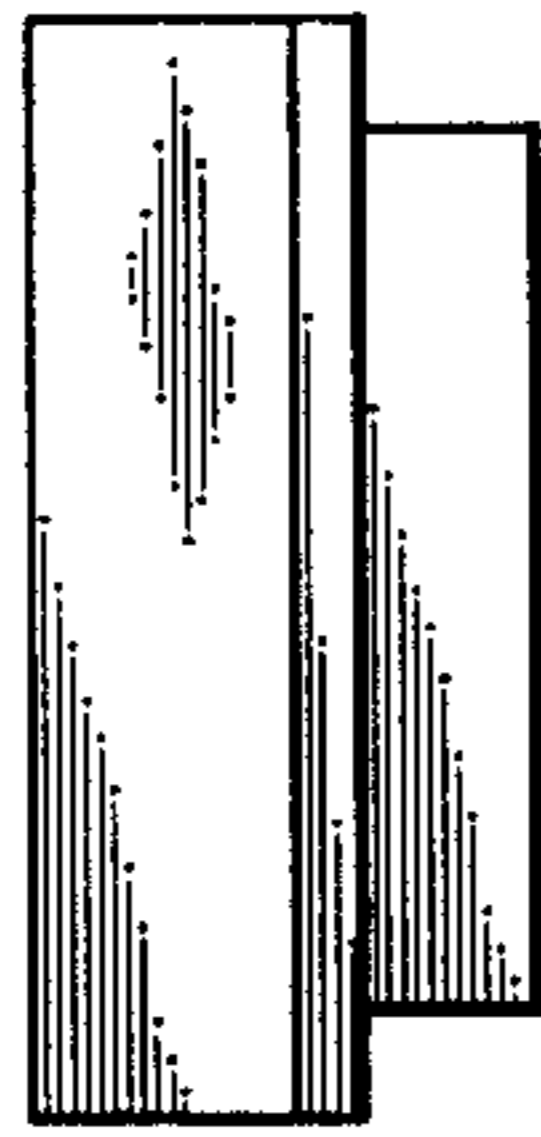

FIG.3

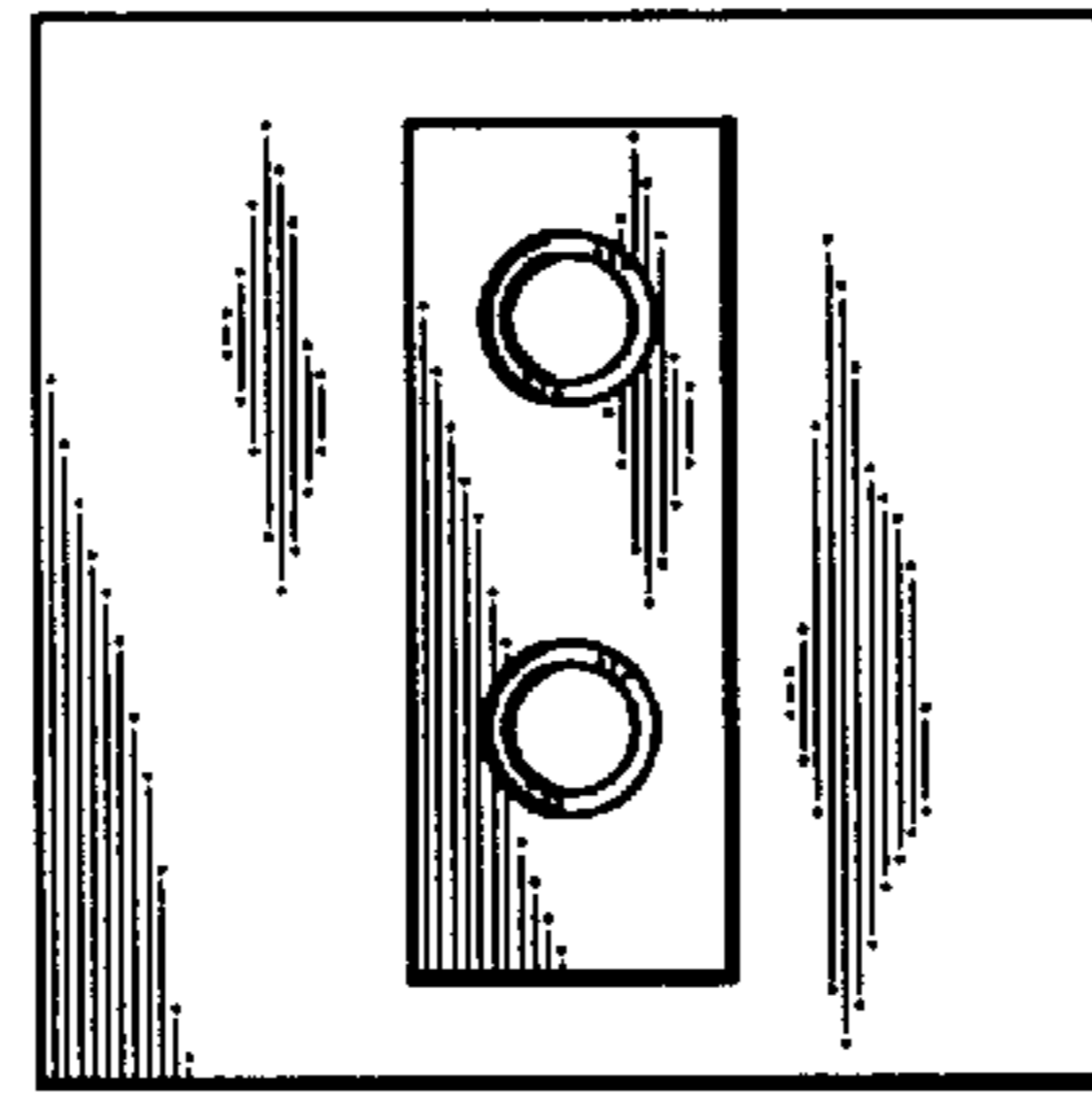

FIG.2

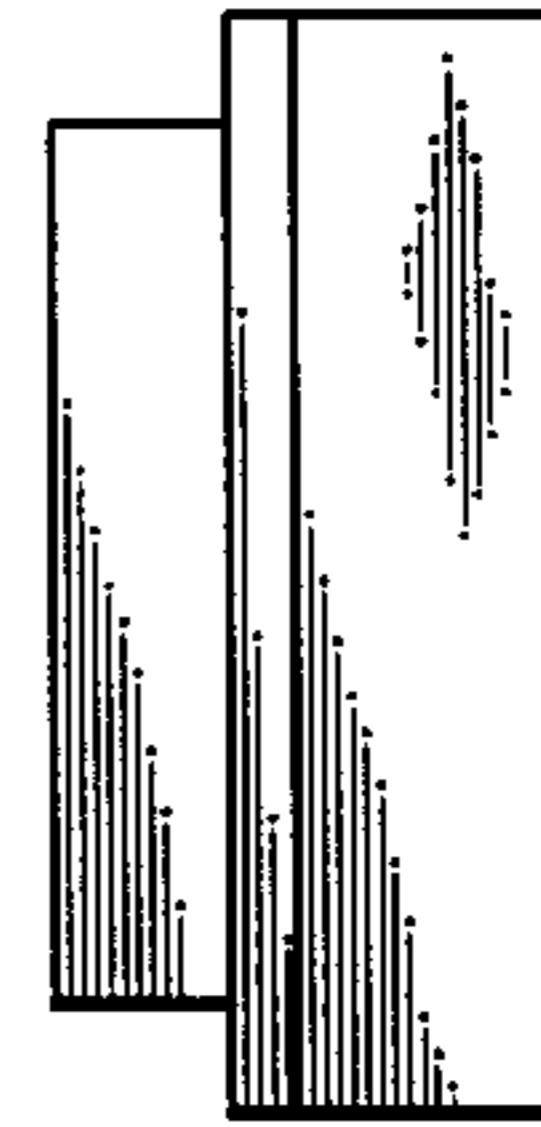

FIG.4

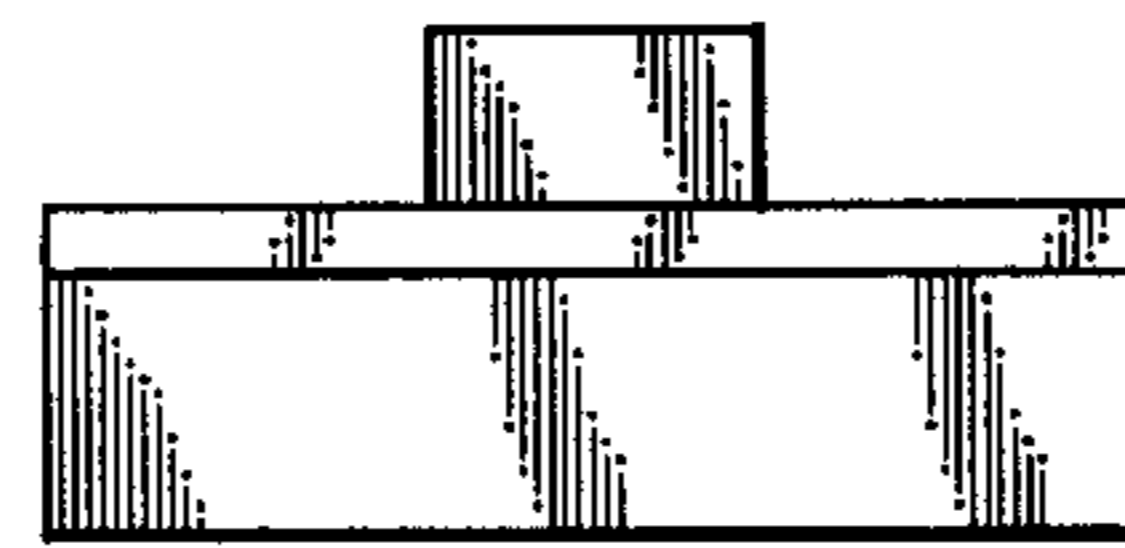

FIG.6

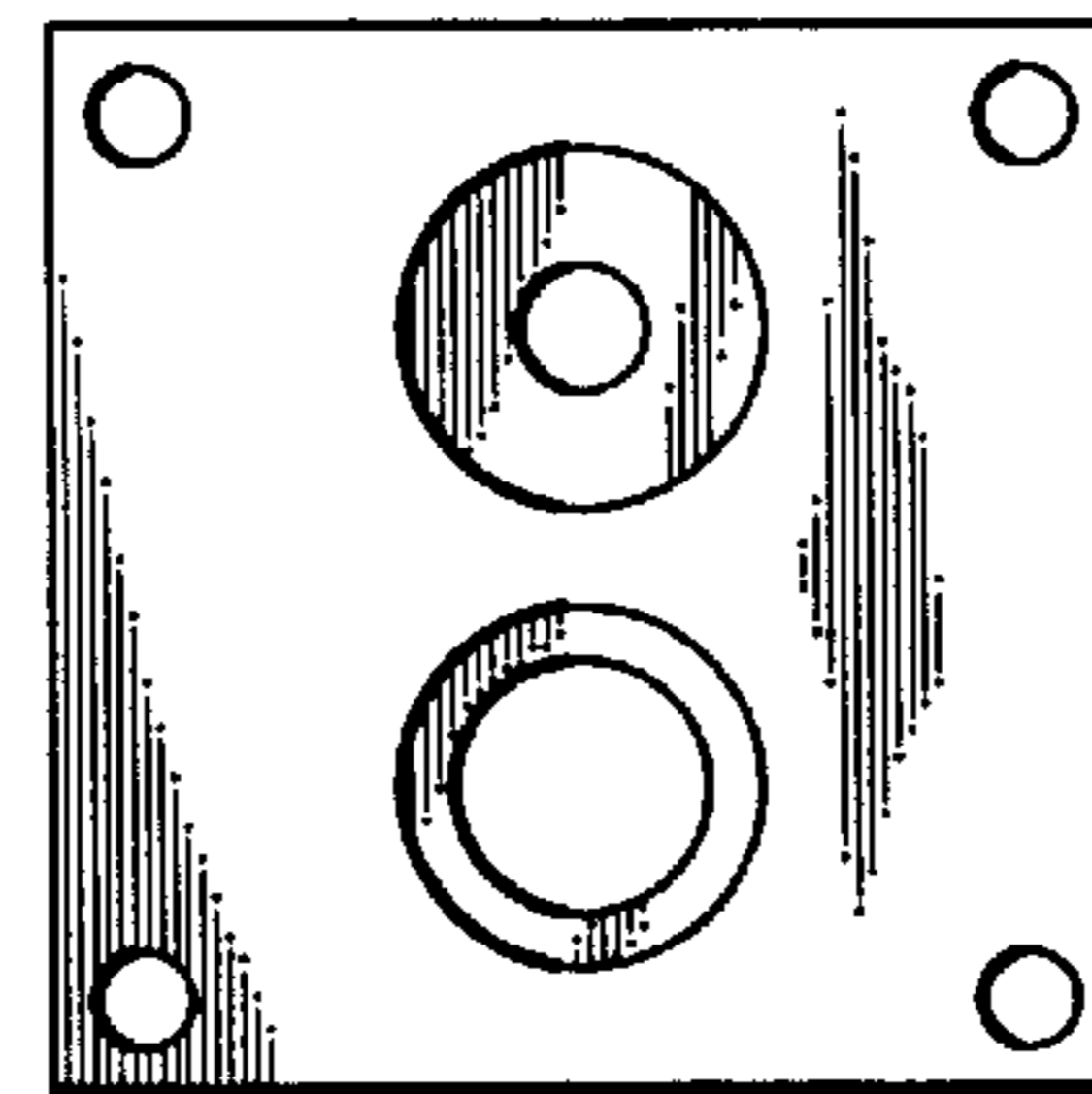

FIG.7

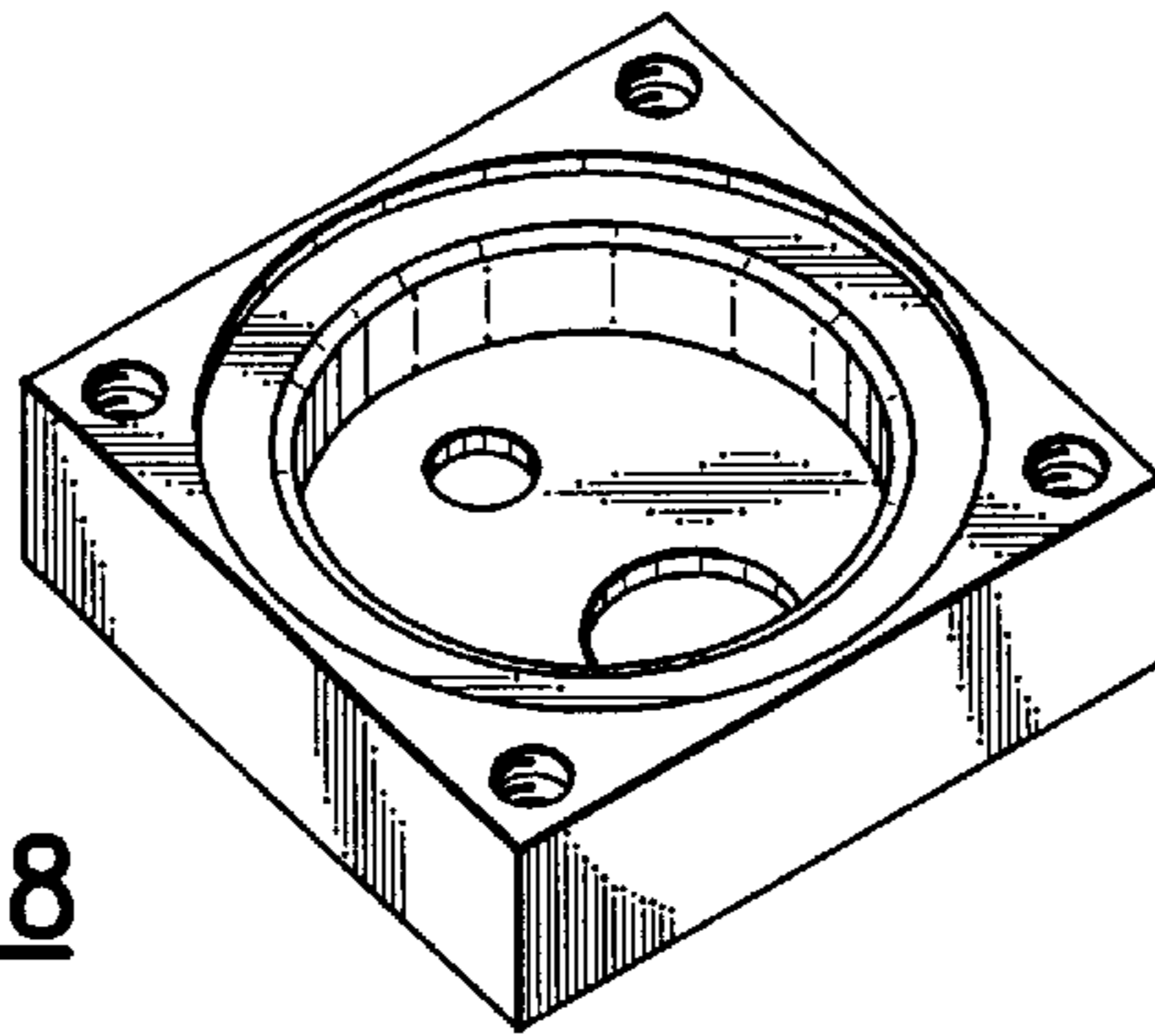

FIG. 8

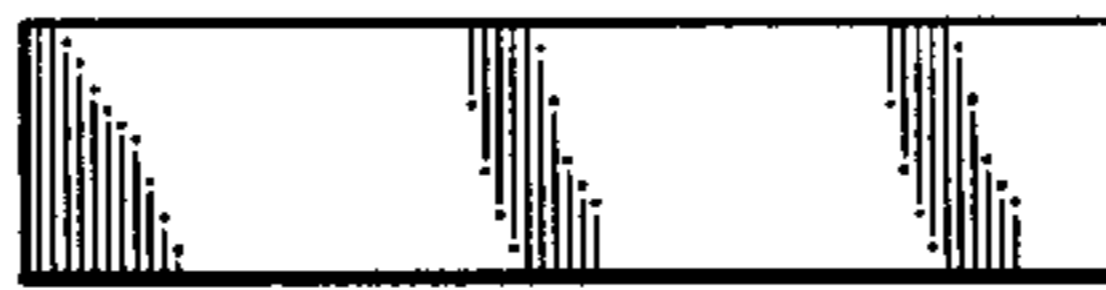

FIG. 12

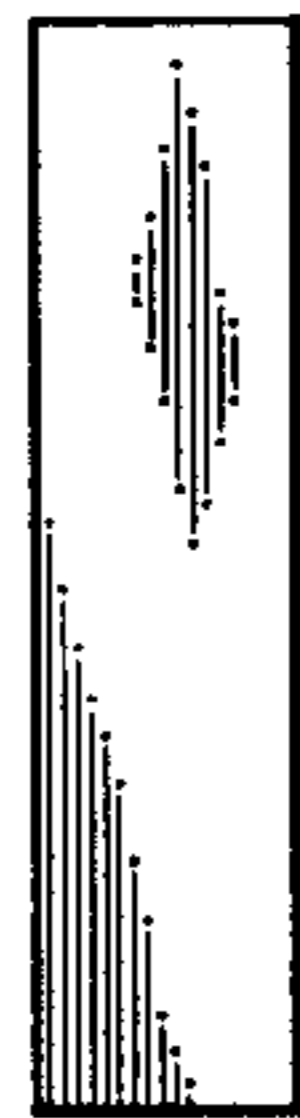

FIG. 10

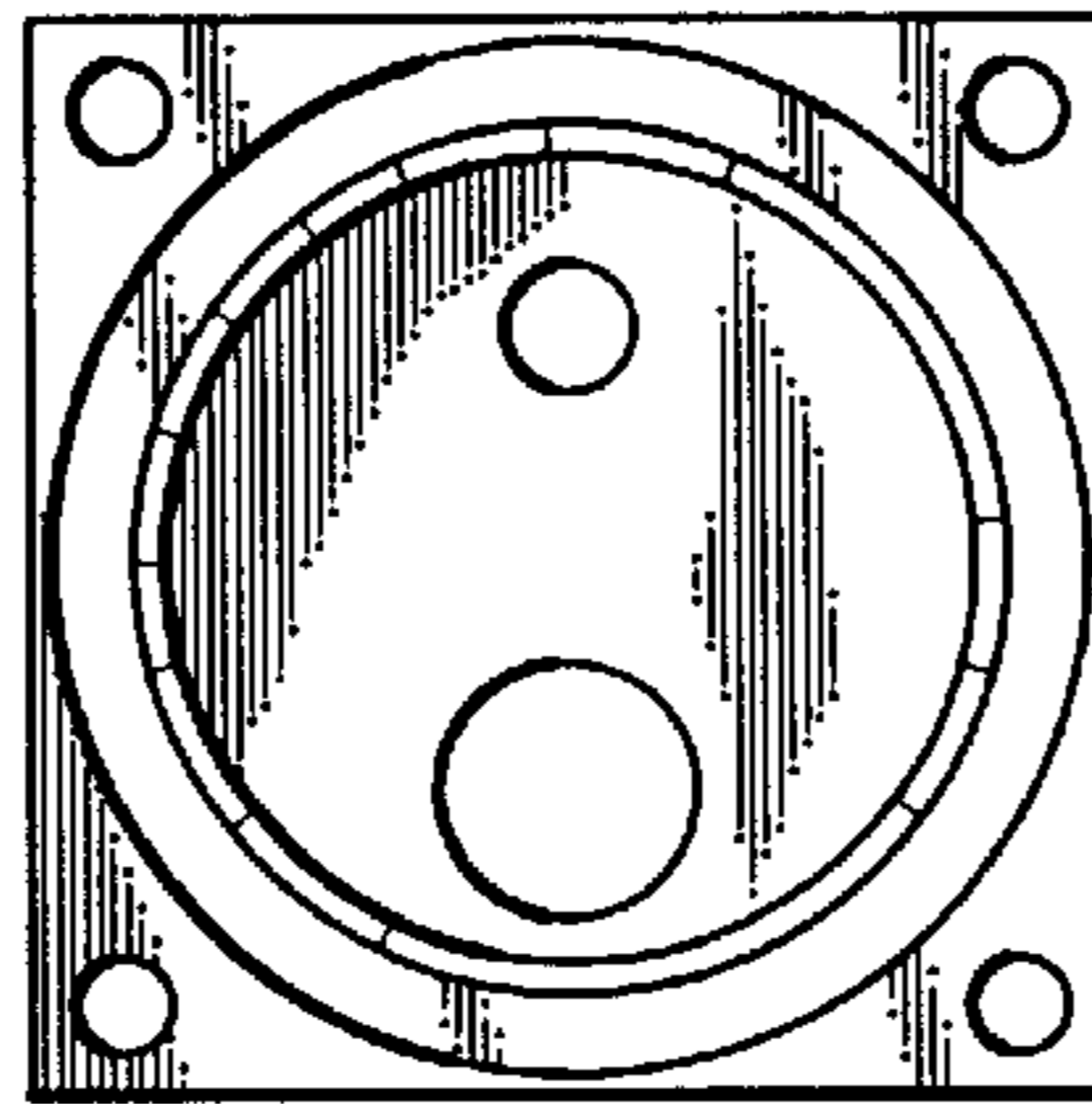

FIG. 9



FIG. 11

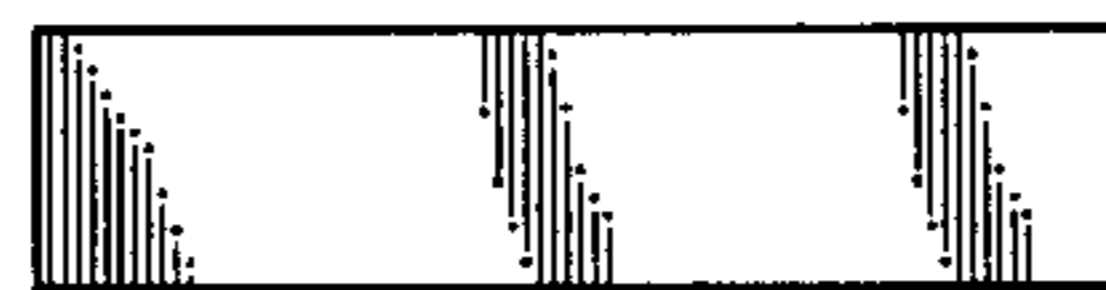

FIG. 13

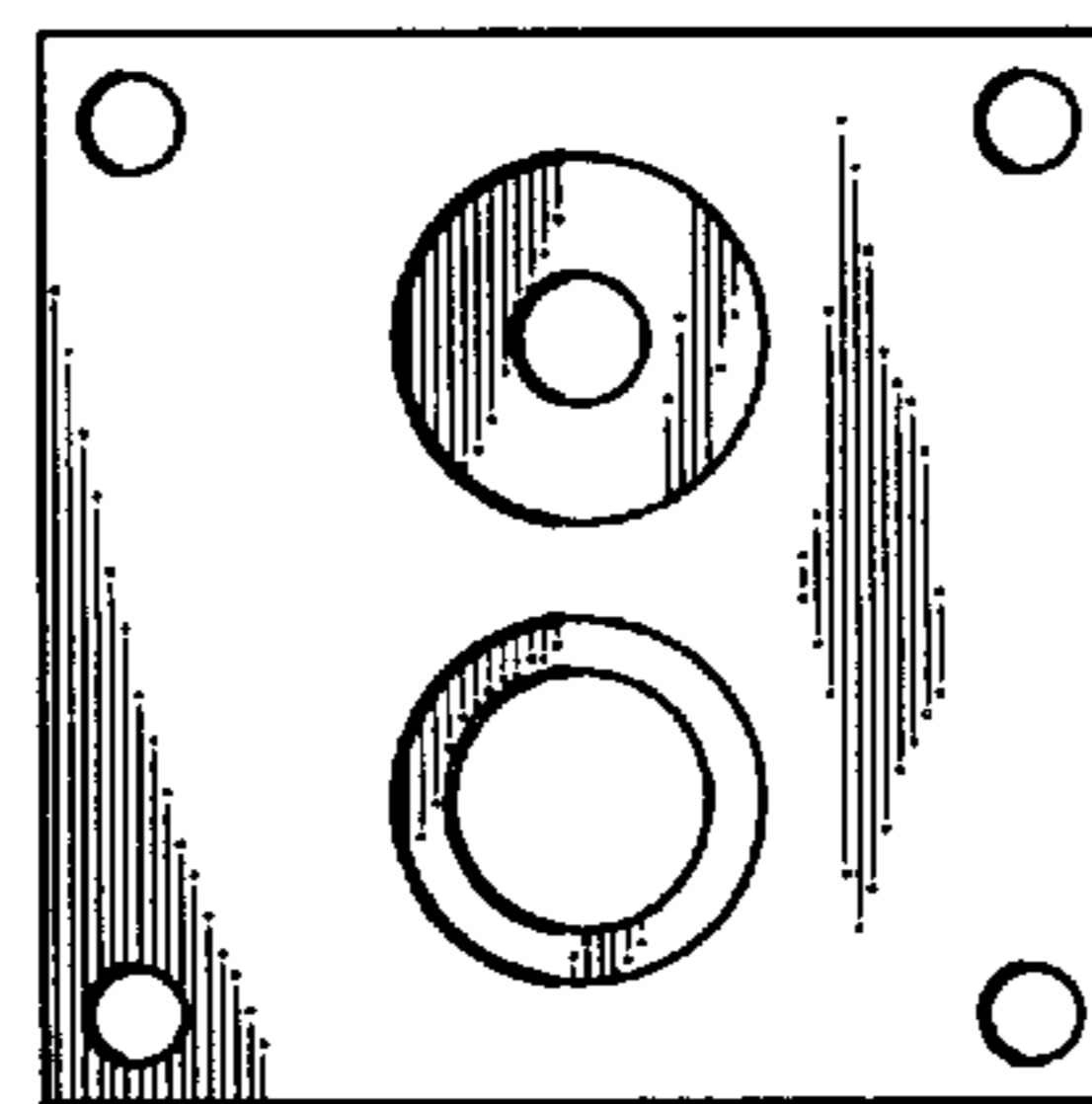

FIG. 14

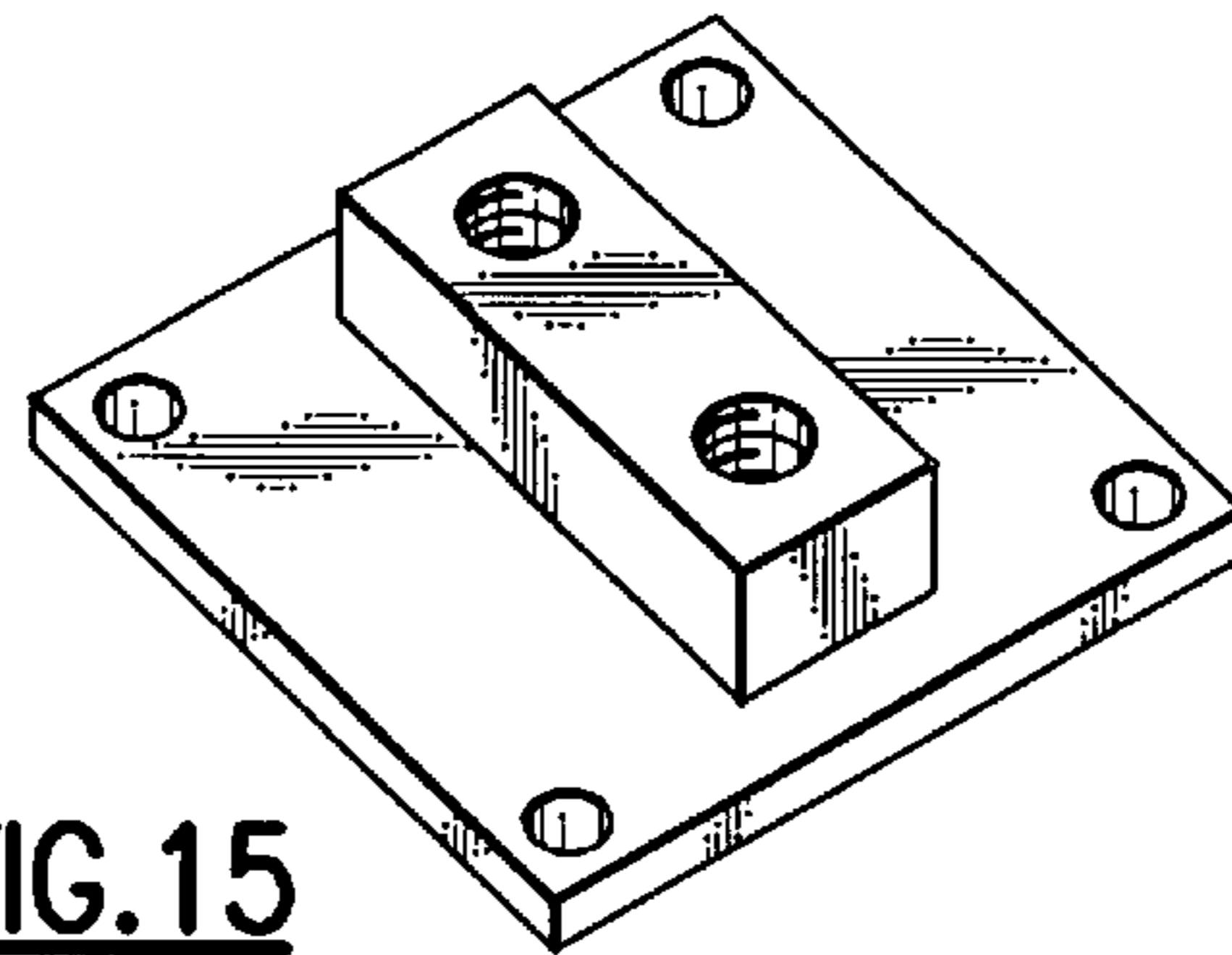

FIG. 15

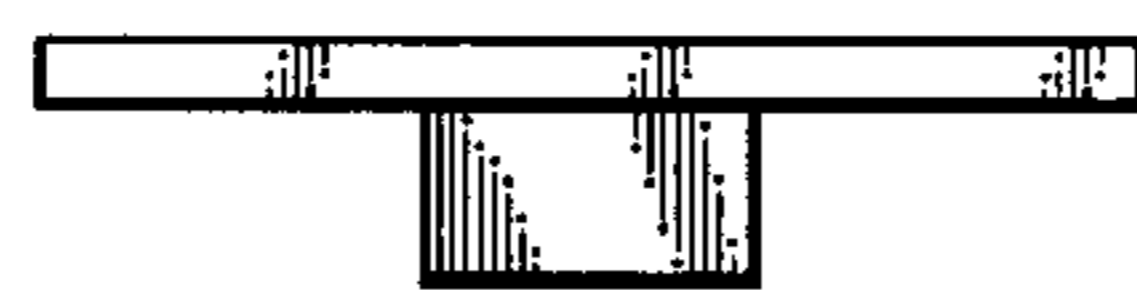

FIG. 19

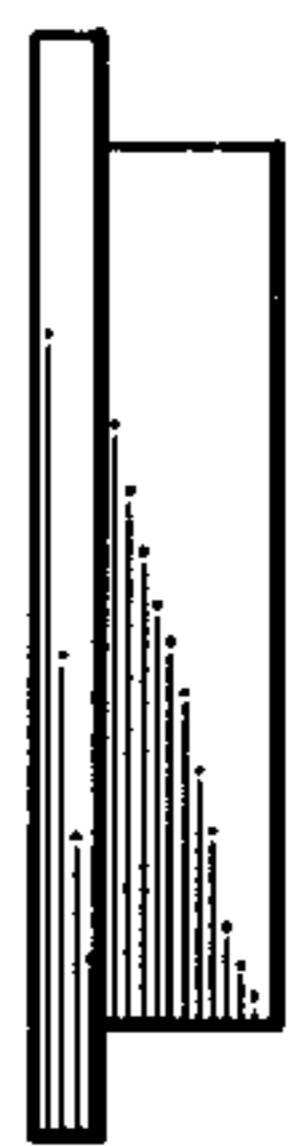

FIG. 17

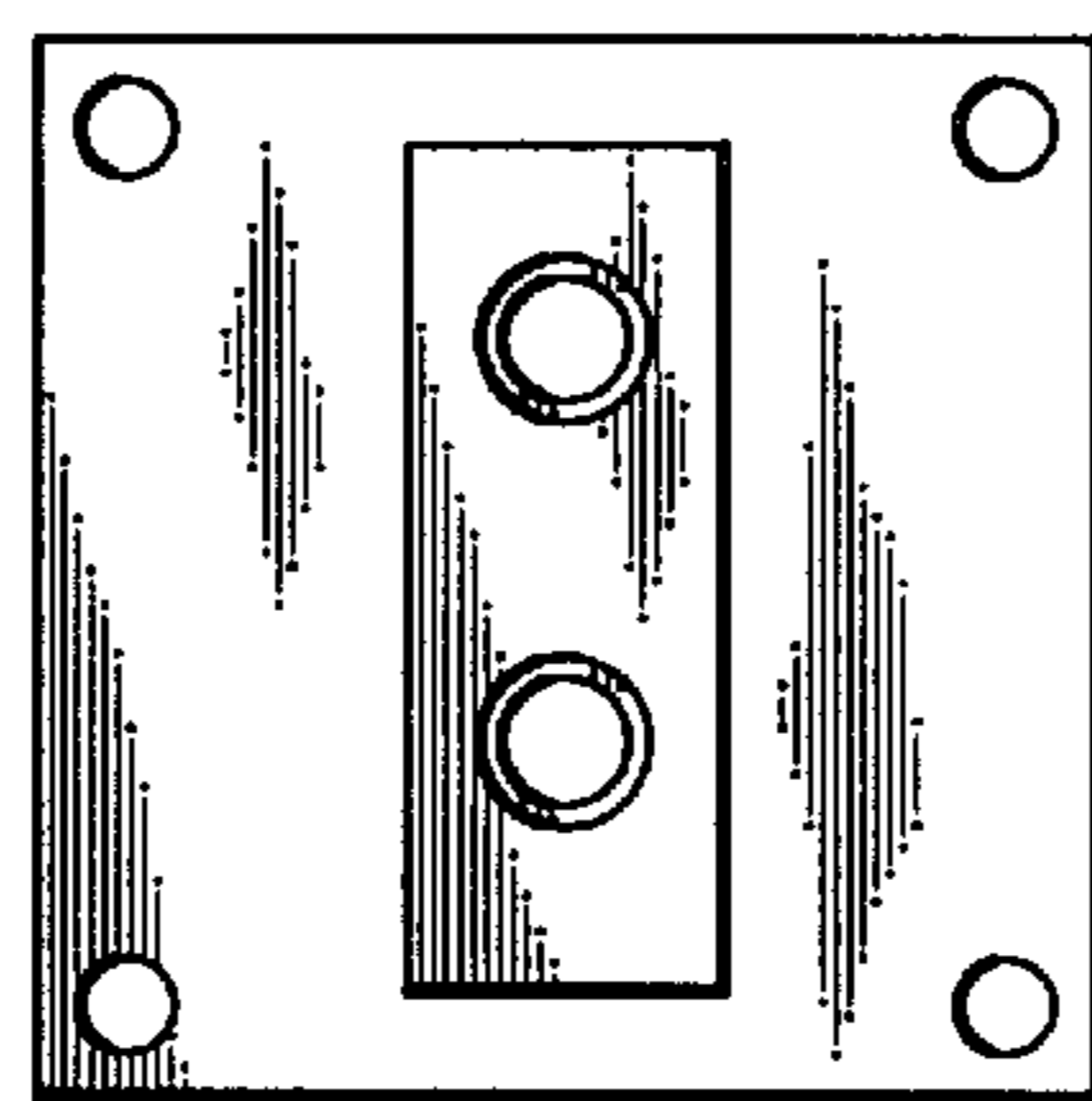

FIG. 16

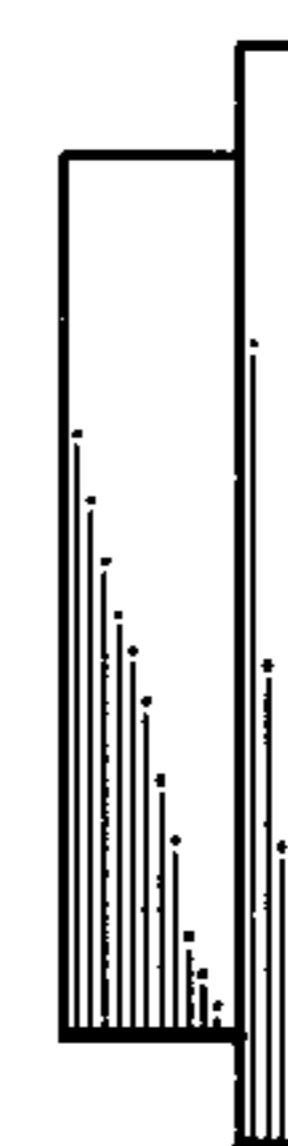

FIG. 18



FIG. 20

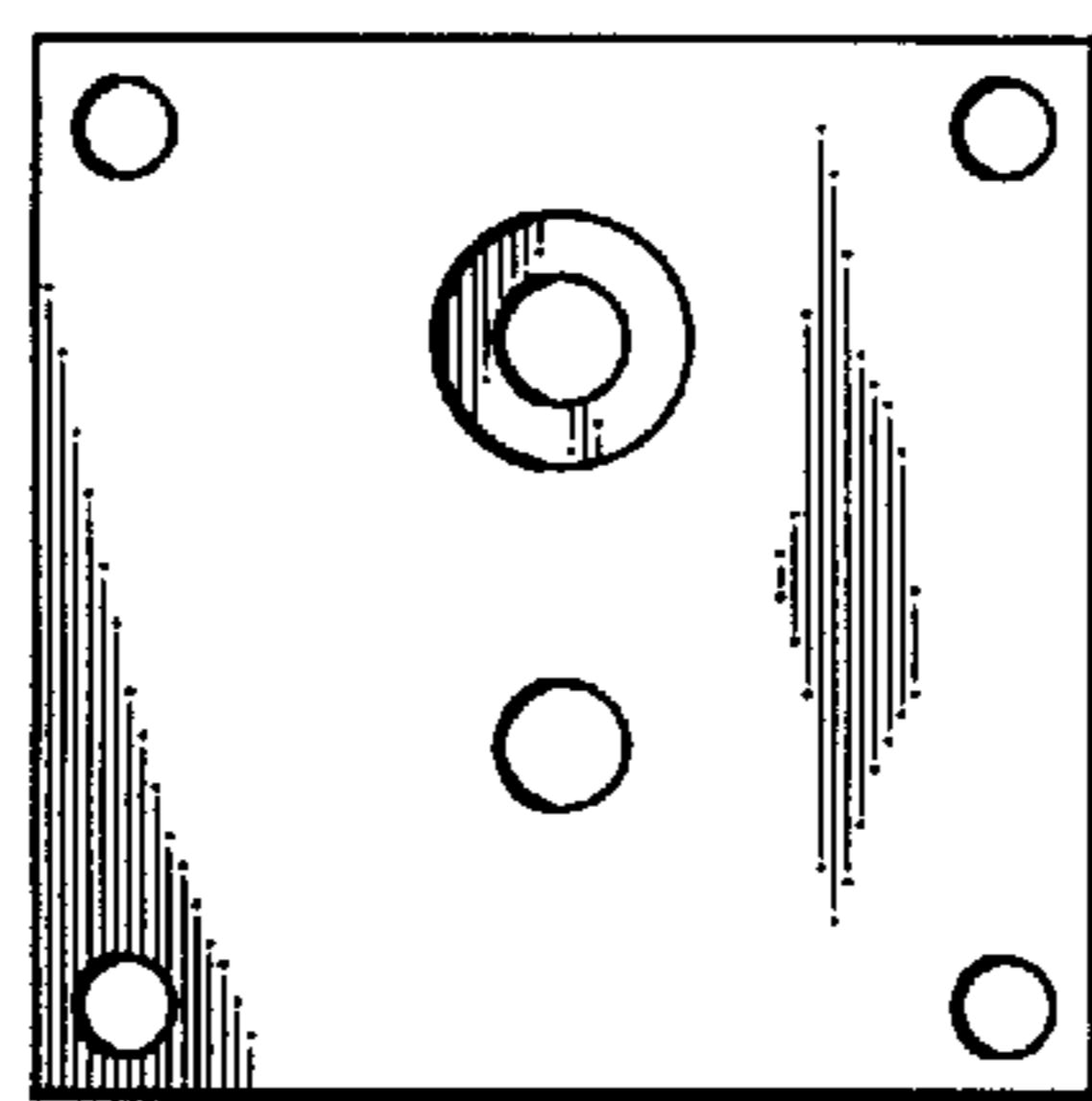

FIG. 21