



US00D541778S

(12) **United States Design Patent**
Kim et al.

(10) **Patent No.:** **US D541,778 S**

(45) **Date of Patent:** **** May 1, 2007**

(54) **PORTABLE PHONE**

(75) Inventors: **Young-Sae Kim**, Palo Alto, CA (US);
Chi-Young Ahn, Seodaemun-Gu (KR);
Beom-Ku Han, Seoul (KR);
Chang-Hwan Hwang, Goyang-Si (KR)

(73) Assignee: **Samsung Electronics Co., Ltd.**,
Suwon-Si (KR)

(**) Term: **14 Years**

(21) Appl. No.: **29/234,754**

(22) Filed: **Jul. 22, 2005**

(30) **Foreign Application Priority Data**

Jan. 26, 2005 (KR) 30-2005-0002650

(51) **LOC (8) Cl.** **14-03**

(52) **U.S. Cl.** **D14/138**

(58) **Field of Classification Search** D14/341-347,
D14/138, 137, 147, 218; 455/575.1, 575.3,
455/575.4, 90.3, 556.1, 556.2; 379/443.01-433.13;
361/814; 348/14.02

See application file for complete search history.

(56) **References Cited**

U.S. PATENT DOCUMENTS

D439,572 S * 3/2001 Kang D14/138
D446,199 S * 8/2001 Xu et al. D14/138
D450,307 S * 11/2001 Xu et al. D14/138
D459,323 S * 6/2002 Jeong D14/138
D459,710 S * 7/2002 Jeong D14/138
D467,235 S * 12/2002 Hawkins et al. D14/138
D475,358 S * 6/2003 Wang et al. D14/138
D478,882 S * 8/2003 Peng et al. D14/138
D485,815 S * 1/2004 Edoff D14/138
6,731,753 B2 * 5/2004 Park et al. 379/433.07

D500,750 S * 1/2005 Arnholt et al. D14/138
D515,542 S * 2/2006 Kent D14/138
2005/0020327 A1 * 1/2005 Chung et al. 455/575.3
2005/0221874 A1 * 10/2005 Cho et al. 455/575.4
2005/0245295 A1 * 11/2005 Lee et al. 455/575.1

OTHER PUBLICATIONS

Motorola A780, announced 3rd quarter 2004, [online], [retrieved on Nov. 9, 2006]. Retrieved from Internet ,<URL: <http://www.gsmarena.com>>.*

BenQ P30, announced 1st quarter 2004, [online], [retrieved on Nov. 9, 2006]. Retrieved from Internet ,<URL: <http://www.gsmarena.com>>.*

Haier N90, announced 2nd quarter 2006, [online], [retrieved on Nov. 20, 2006]. Retrieved from Internet ,<URL: <http://www.gsmarena.com>>.*

* cited by examiner

Primary Examiner—Jeffrey Asch

Assistant Examiner—Bridget L. Eland

(74) *Attorney, Agent, or Firm*—Staas & Halsey LLP

(57) **CLAIM**

The ornamental design for the portable phone, as shown and described.

DESCRIPTION

FIG. 1 is a perspective view of the portable phone showing our design;

FIG. 2 is a front view thereof;

FIG. 3 is a rear view thereof;

FIG. 4 is a left side view thereof;

FIG. 5 is a right side view thereof;

FIG. 6 is a top plan view thereof; and,

FIG. 7 is a bottom plan view thereof.

1 Claim, 4 Drawing Sheets

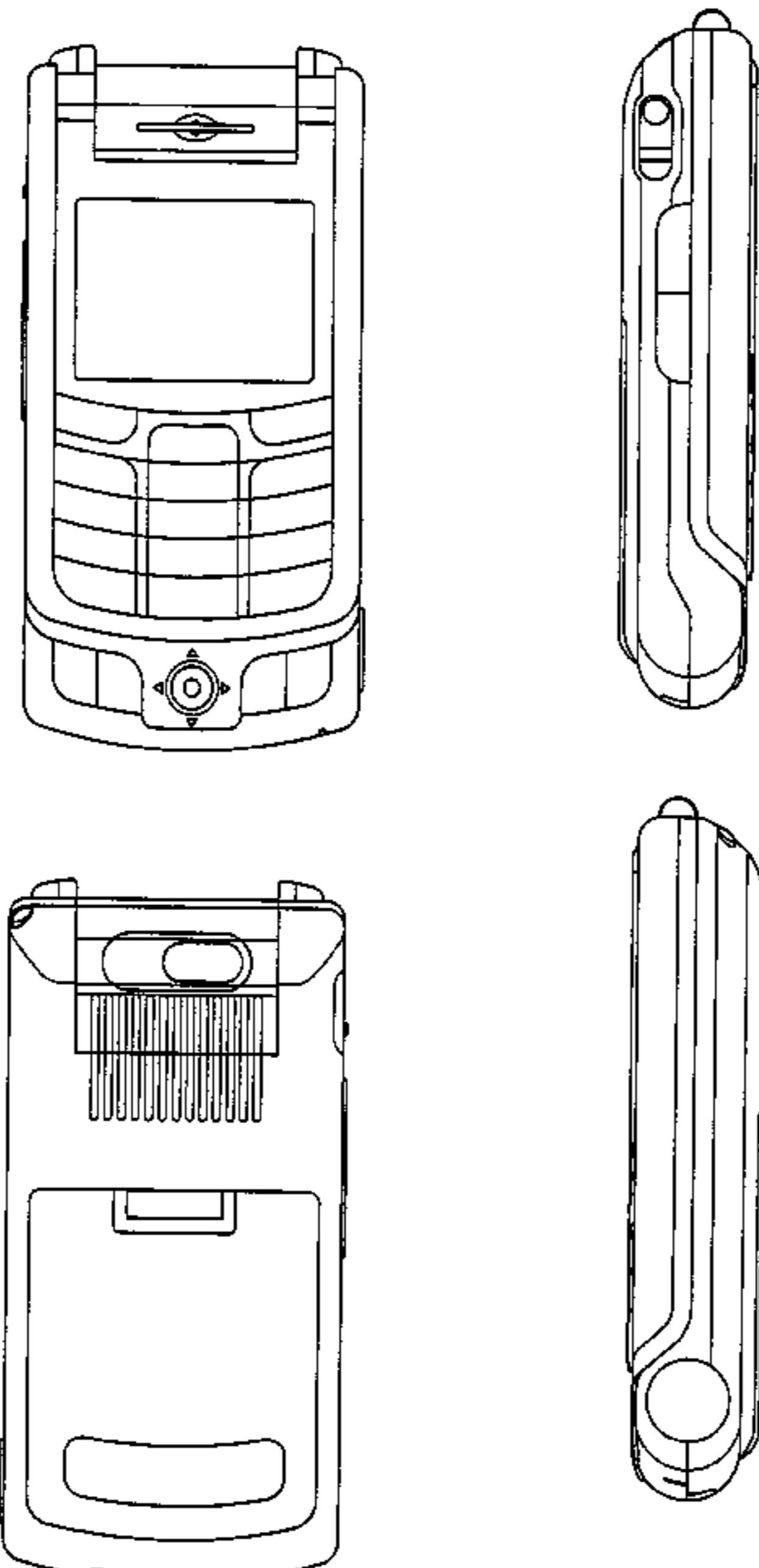
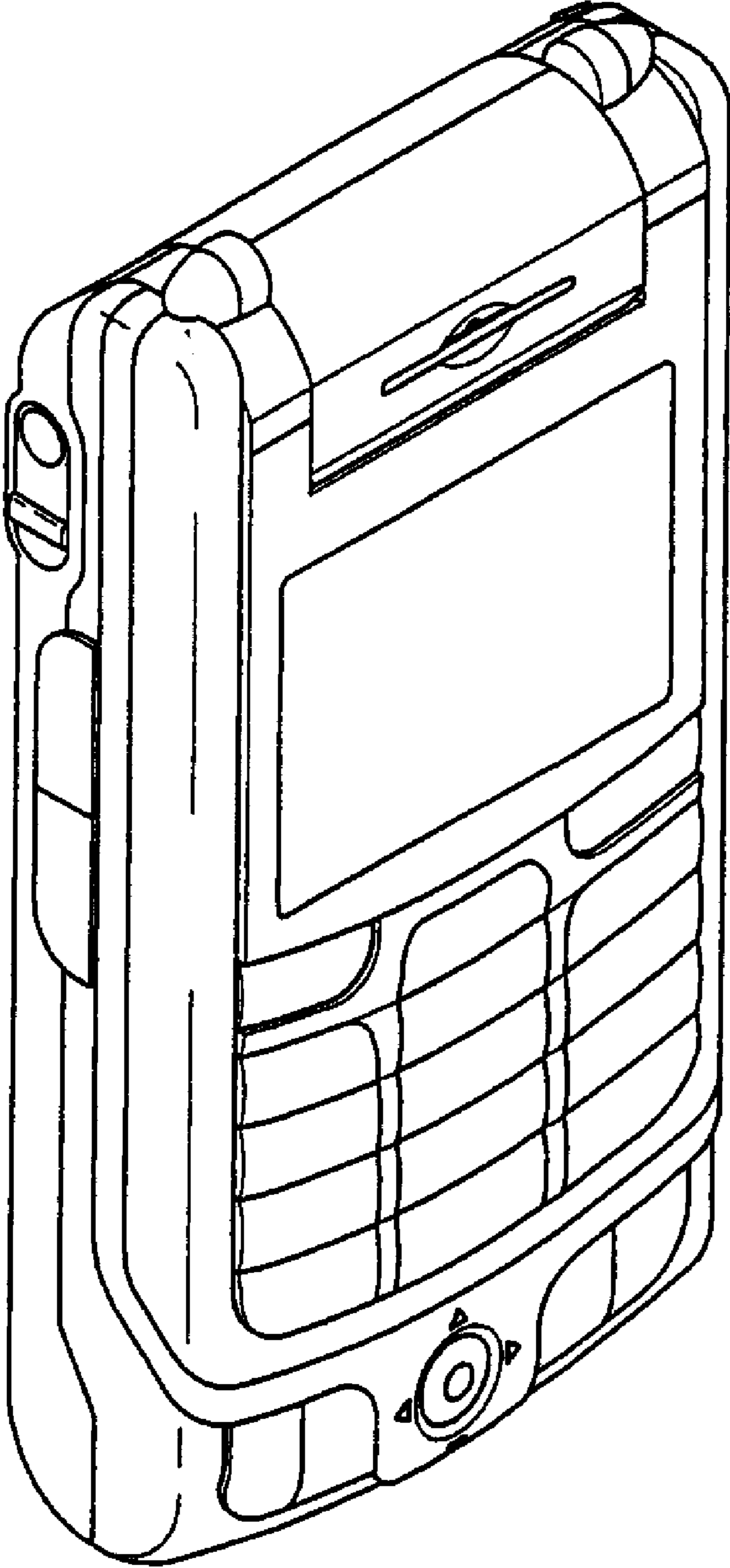

FIG. 1



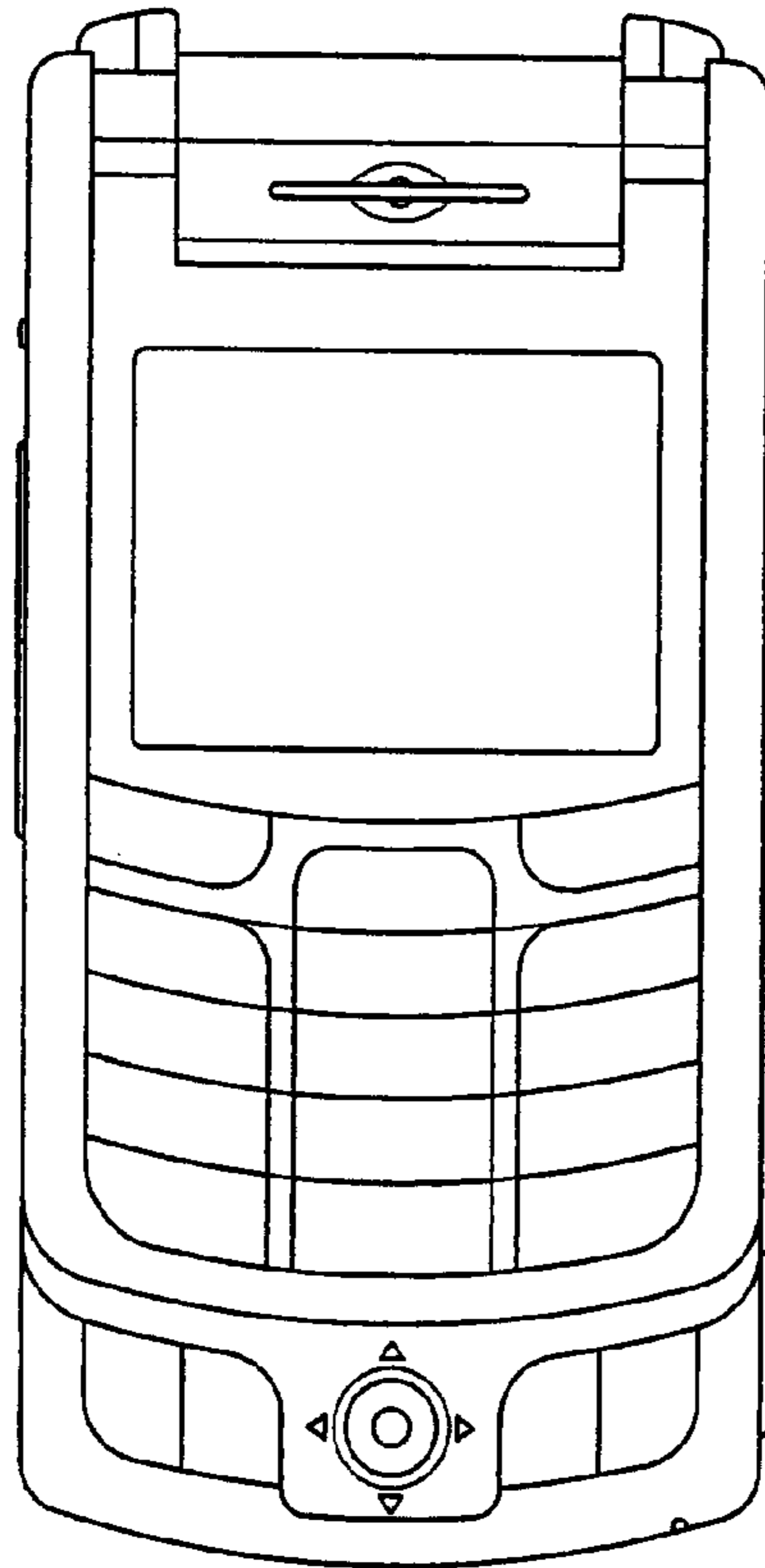

FIG. 2

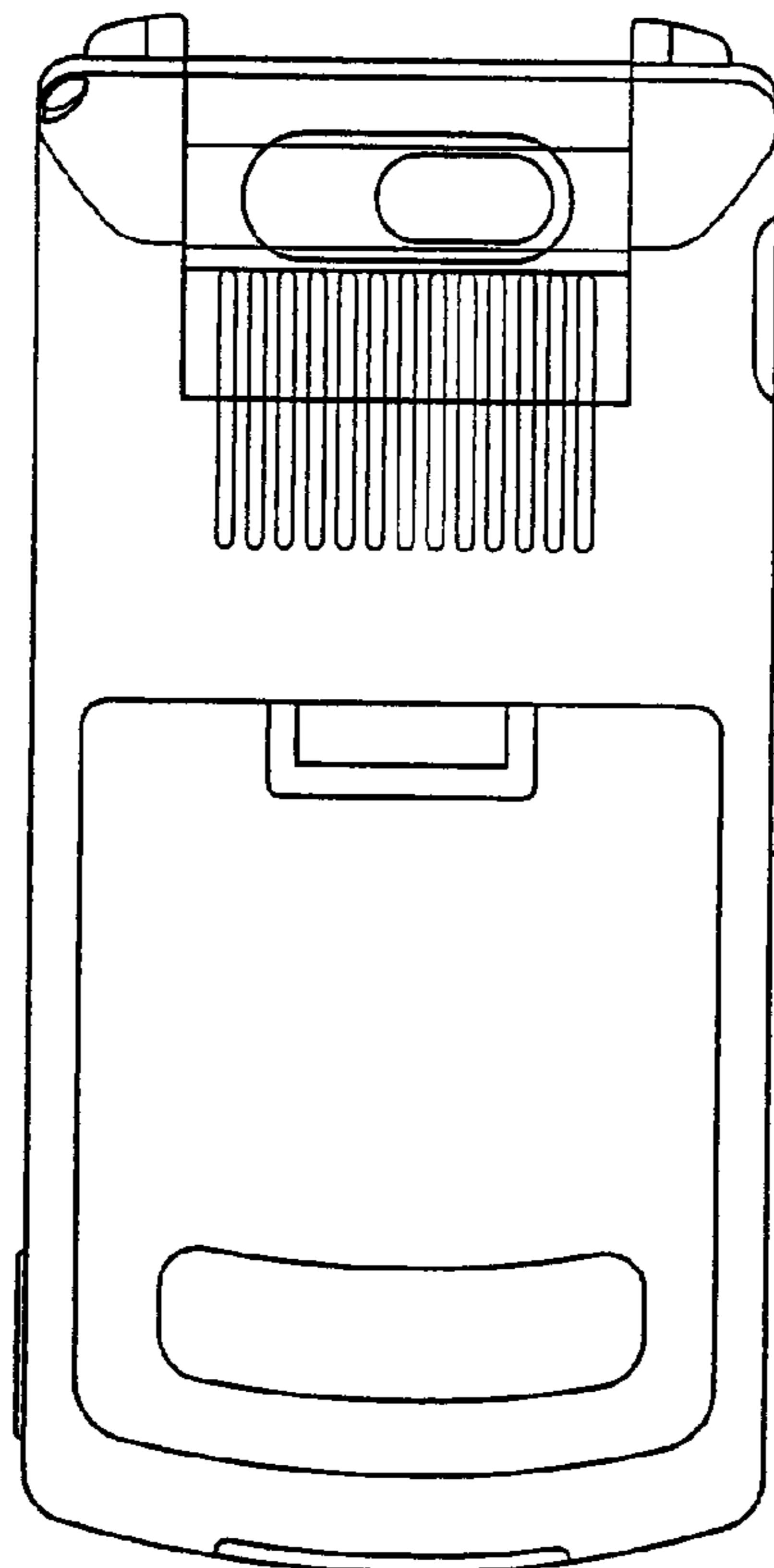

FIG. 3

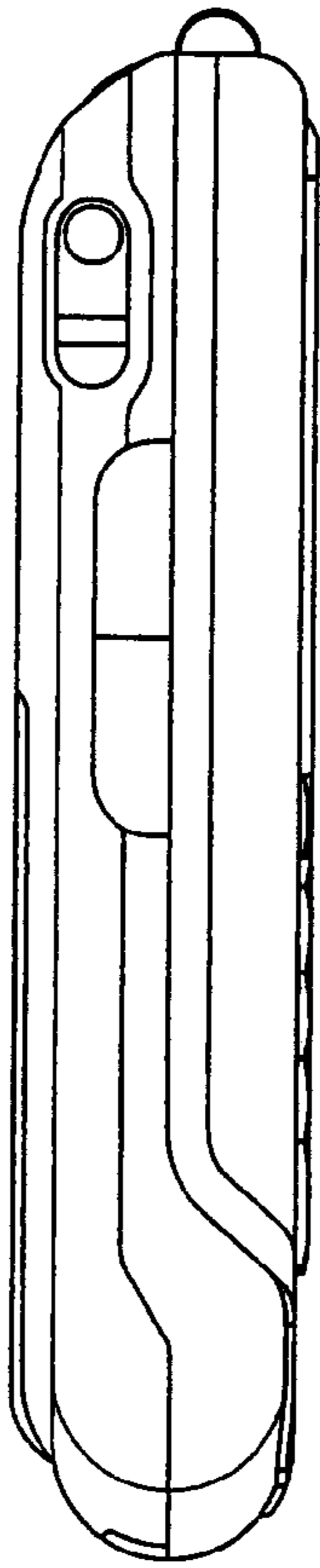

FIG. 4

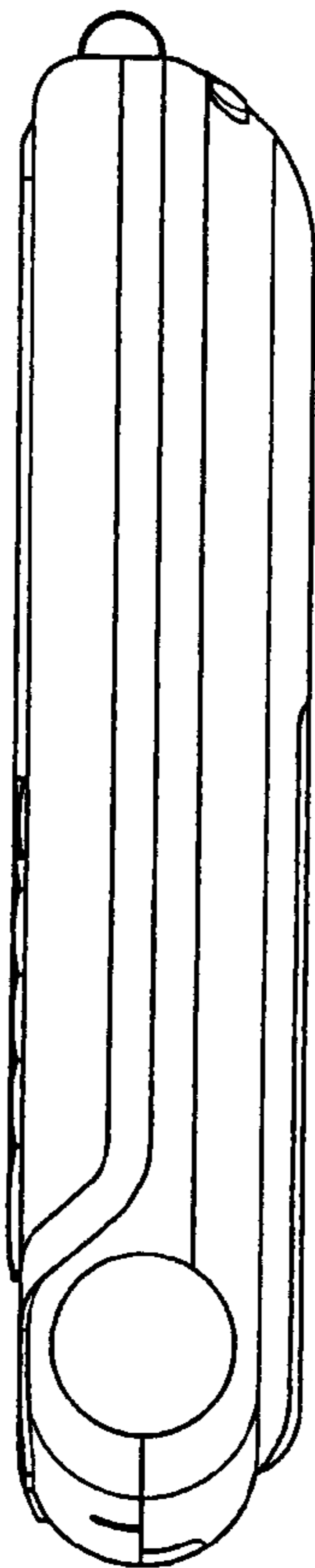

FIG. 5

FIG. 6

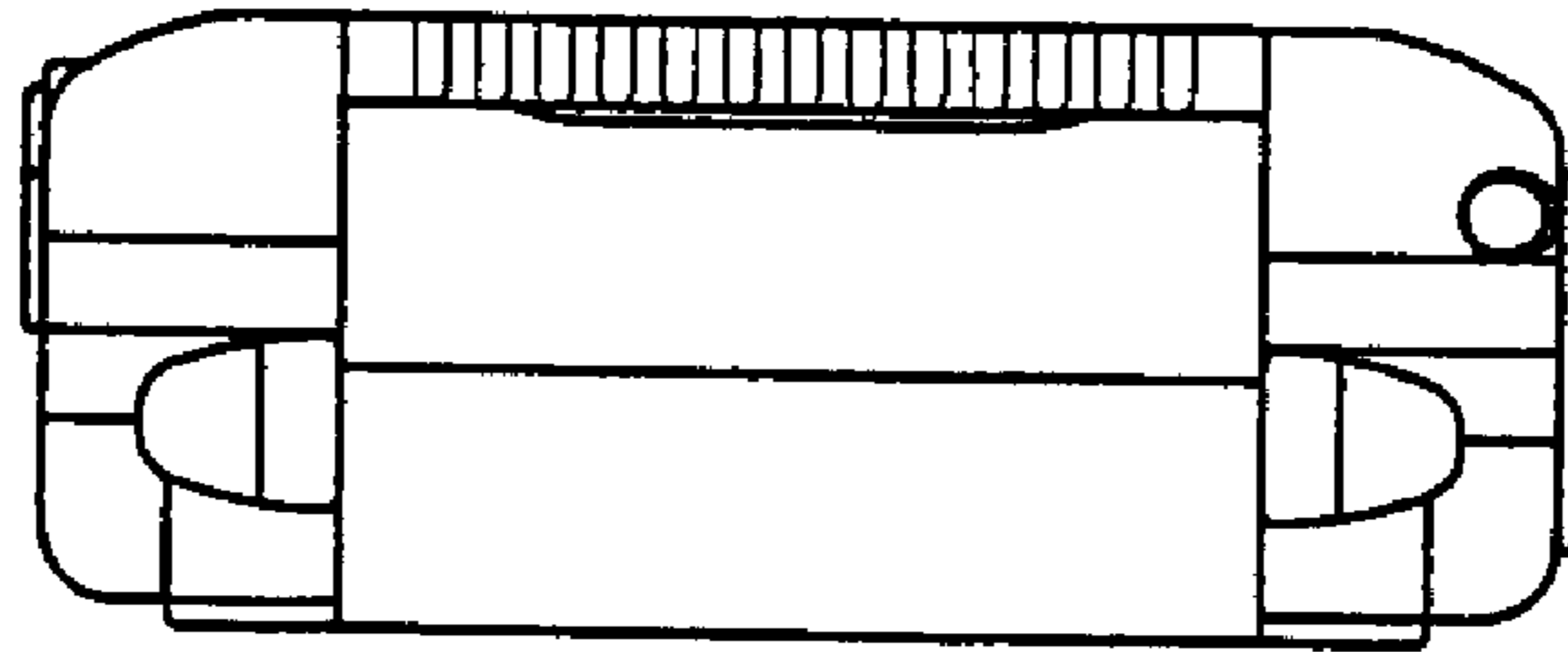

FIG. 7

