



US00D541616S

(12) **United States Design Patent**
Bruno et al.

(10) **Patent No.:** **US D541,616 S**

(45) **Date of Patent:** **** May 1, 2007**

(54) **CONTOURED HANDLE FOR TAPING KNIFE**

(75) Inventors: **Robert Bruno**, Avon, CT (US); **Jason Lind**, Barkhamsted, CT (US); **Matthew Earle Myers**, Naperville, IL (US)

(73) Assignee: **United States Gypsum Company**, Chicago, IL (US)

(**) Term: **14 Years**

(21) Appl. No.: **29/234,782**

(22) Filed: **Jul. 22, 2005**

(51) **LOC (8) Cl.** **08-05**

(52) **U.S. Cl.** **D8/107**

(58) **Field of Classification Search** D8/45,
D8/14, 107, 21, 27, 47, 82-87, 99-101, DIG. 7;
D7/393, 395, 688, 693; 15/235.3, 236.01;
16/DIG. 12, DIG. 18, DIG. 19, 110.1, 421,
16/422, 430, 431, 435; 81/177.1, 436-439,
81/489-492, 60-62, 63.1; 192/43.2

See application file for complete search history.

(56) **References Cited**

U.S. PATENT DOCUMENTS

D157,904 S	3/1950	Reusch	
D206,517 S	12/1966	Han	
3,971,094 A	7/1976	Solf et al.	
D282,716 S	2/1986	Heinis et al.	
D319,379 S	8/1991	Cummings et al.	
5,390,572 A	2/1995	Gakhar et al.	
5,615,445 A	4/1997	Kelsay et al.	
D397,281 S	* 8/1998	Hsu et al.	D8/95
5,850,663 A	12/1998	Hardy et al.	
5,956,799 A	9/1999	Panaccione et al.	
6,131,290 A	10/2000	Chiou	
D441,269 S	5/2001	Tsai	
D444,692 S	* 7/2001	Marquardt	D8/107
D446,104 S	8/2001	Chen	

D462,251 S	*	9/2002	Collins et al.	D8/107
RE38,093 E		4/2003	Chiou	
D483,244 S		12/2003	Chen	
D483,638 S		12/2003	Jimenez	
6,668,751 B1		12/2003	Henke	
6,742,215 B2		6/2004	Panifili et al.	
D498,124 S		11/2004	Mitchell	
D500,600 S		1/2005	Hay et al.	
2003/0084545 A1		5/2003	Cheng	

* cited by examiner

Primary Examiner—Alan P. Douglas

Assistant Examiner—Barbara Fox

(74) *Attorney, Agent, or Firm*—Greer, Burns & Crain, Ltd.;
Michael M. Geoffrey; David F. Janci

(57) **CLAIM**

The ornamental design for a contoured handle for taping knife, as shown and described.

DESCRIPTION

FIG. 1 is a front view of the present handle, the rear being identical;
 FIG. 2 is a left side view of same, the right side being identical;
 FIG. 3 is a top view of the handle of FIG. 1;
 FIG. 4 is a bottom view of same;
 FIG. 5 is top perspective view of the handle of FIG. 1;
 FIG. 6 is a front view of an alternate embodiment of the handle of FIG. 1, the rear view being identical;
 FIG. 7 is a left side view of same, the right side being identical;
 FIG. 8 is a top view of the handle of FIG. 6;
 FIG. 9 is a bottom view of same; and,
 FIG. 10 is a top perspective view of the handle of FIG. 6.
 The subject matter depicted in broken lines is not intended to be part of the claimed invention and is shown only for environment purposes.

1 Claim, 8 Drawing Sheets

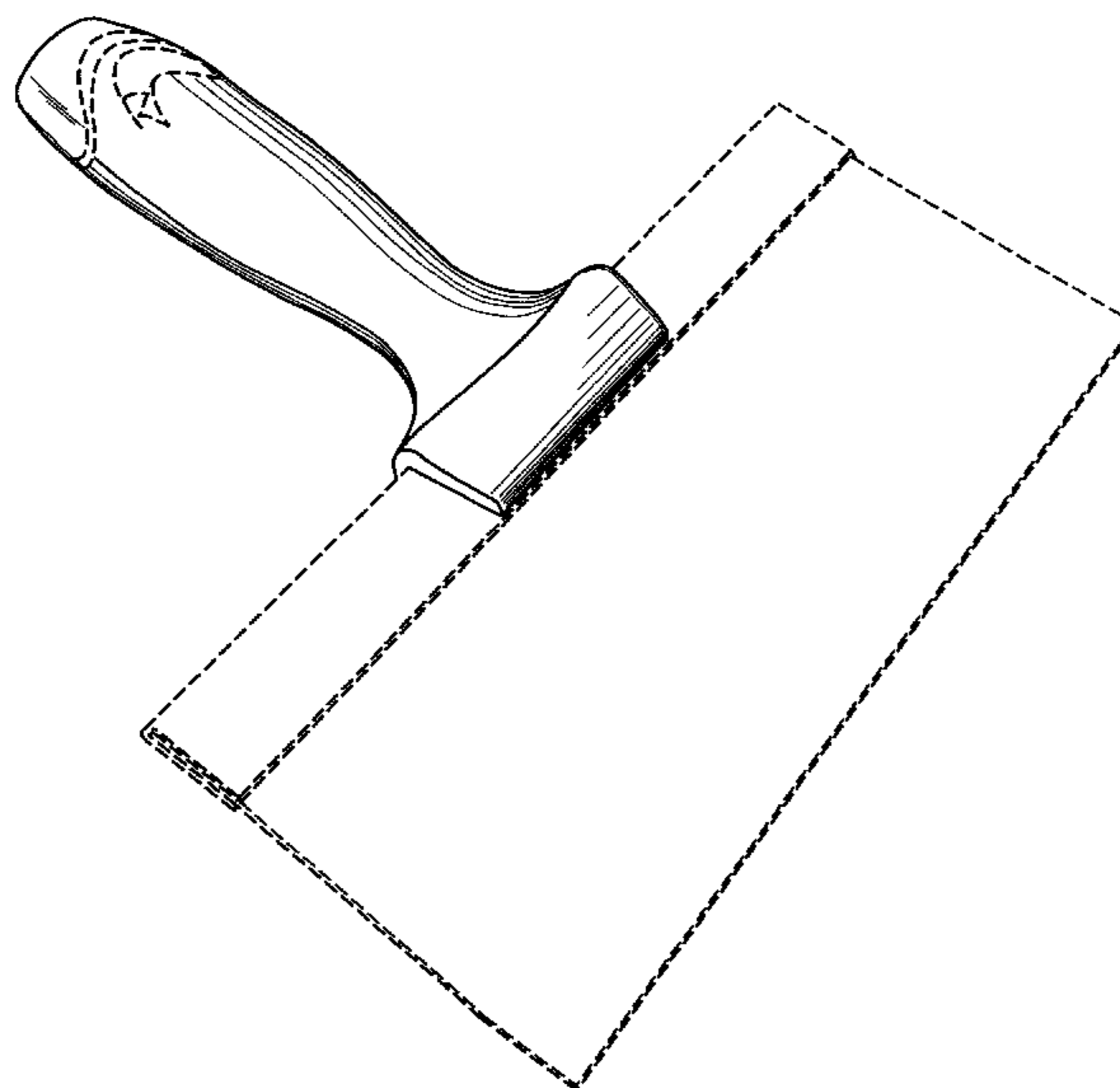

FIG. 1

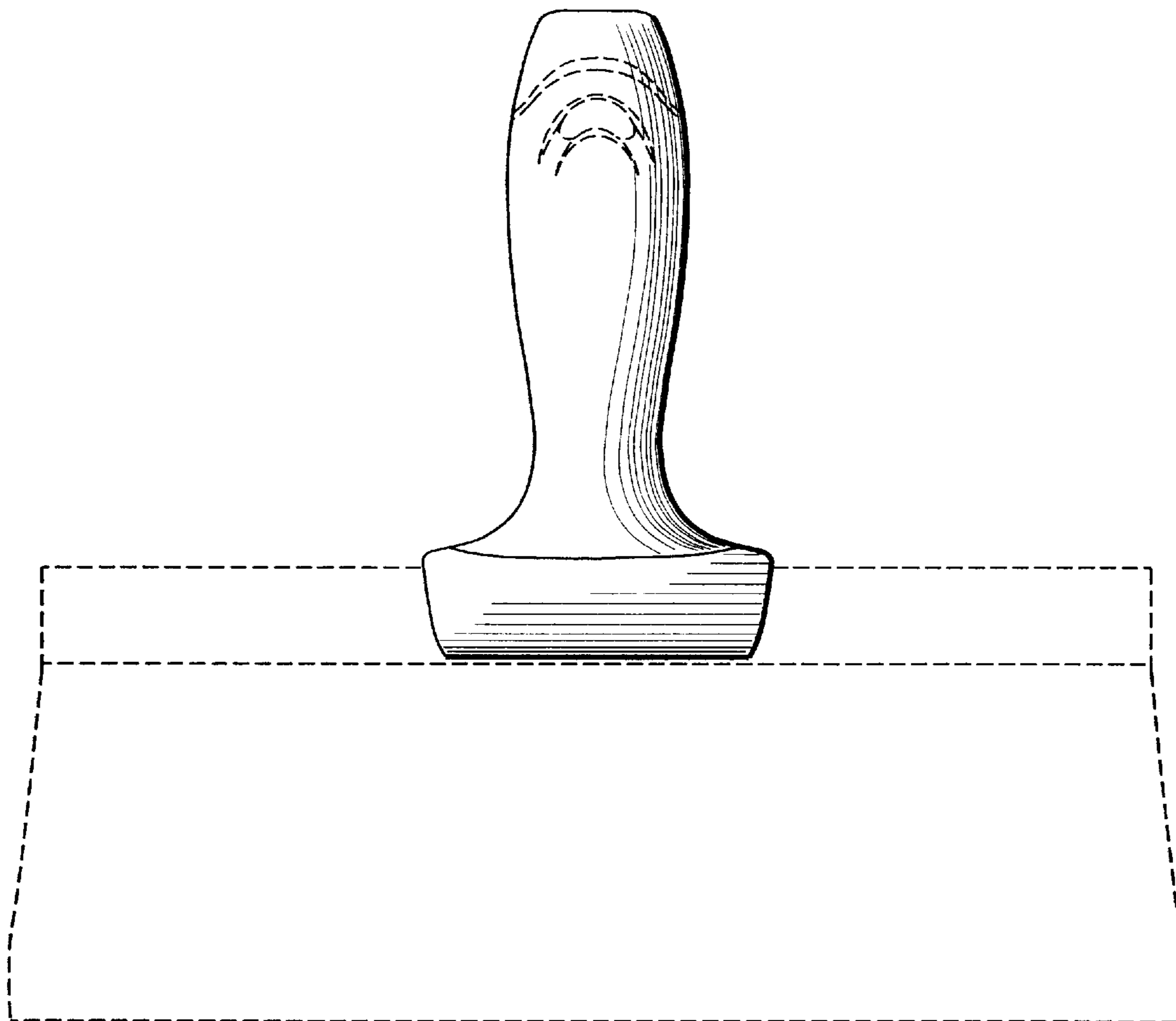
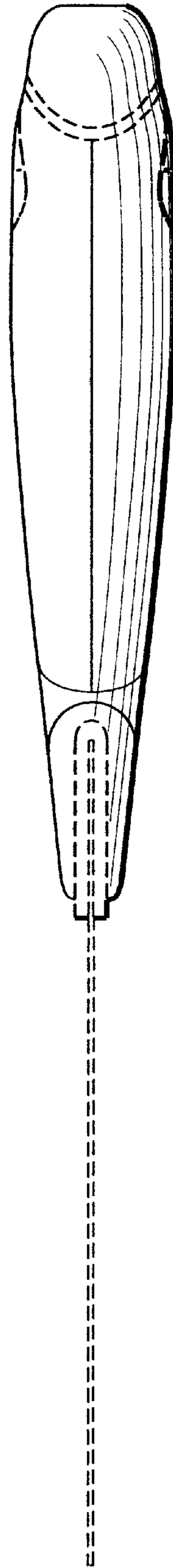

FIG. 2



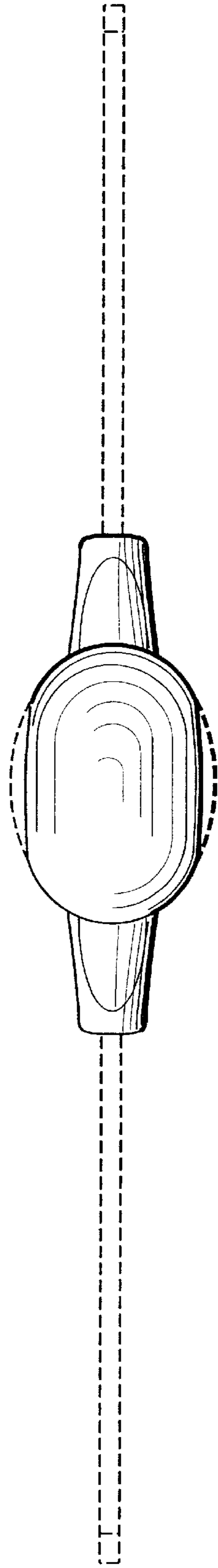

FIG. 3

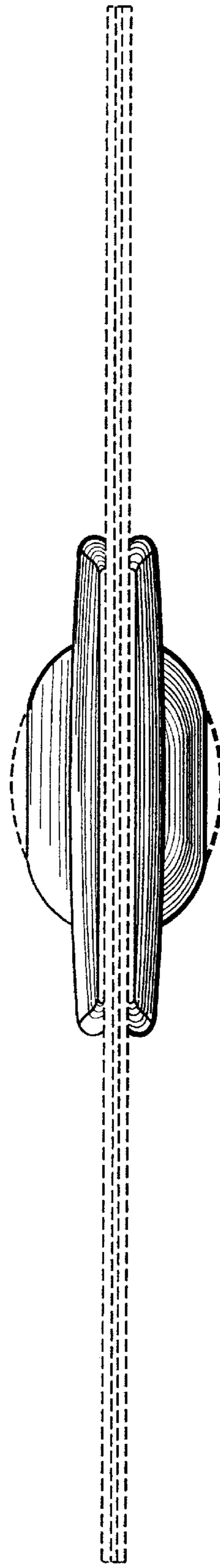

FIG. 4

FIG. 5

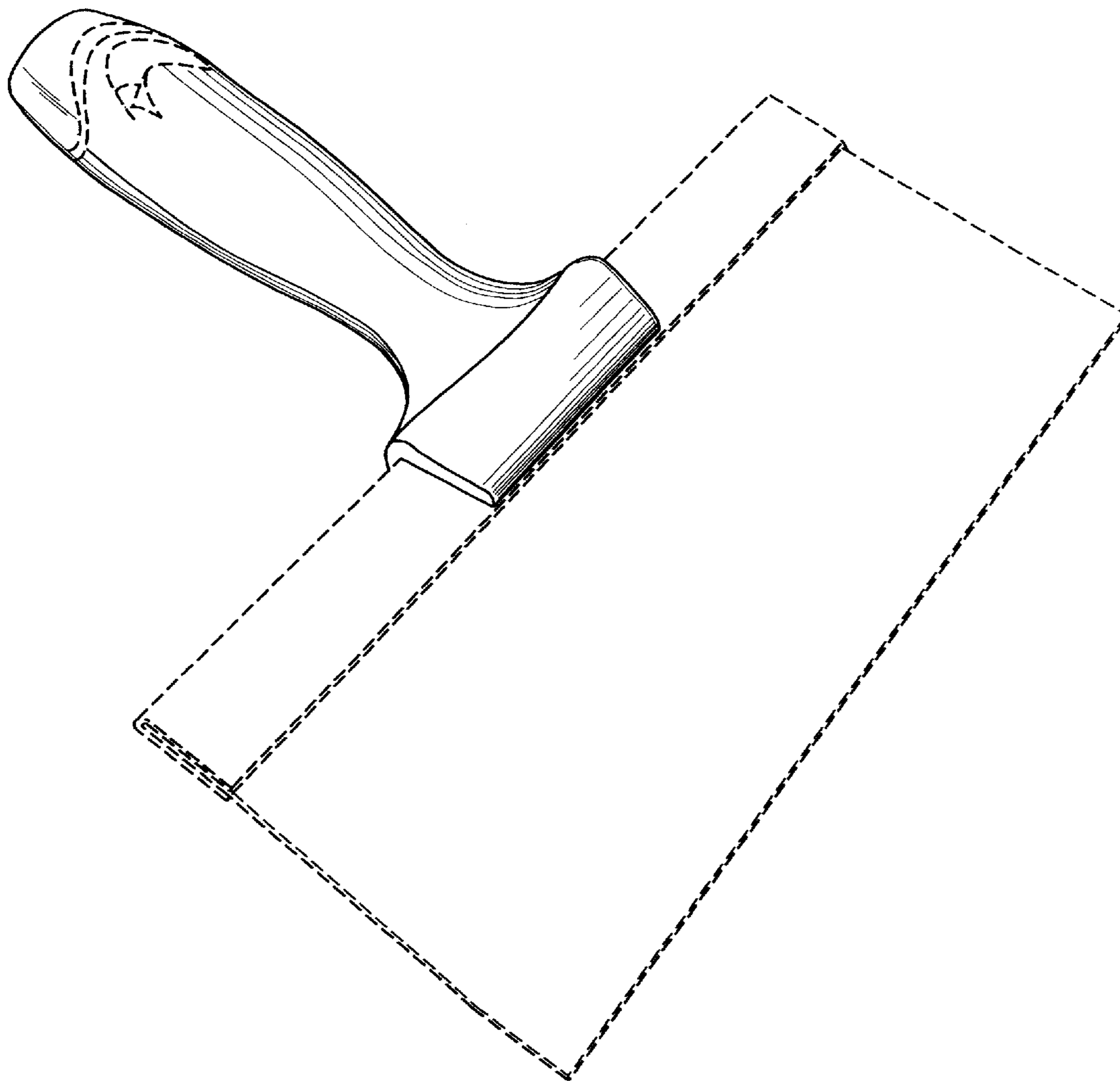

FIG. 6

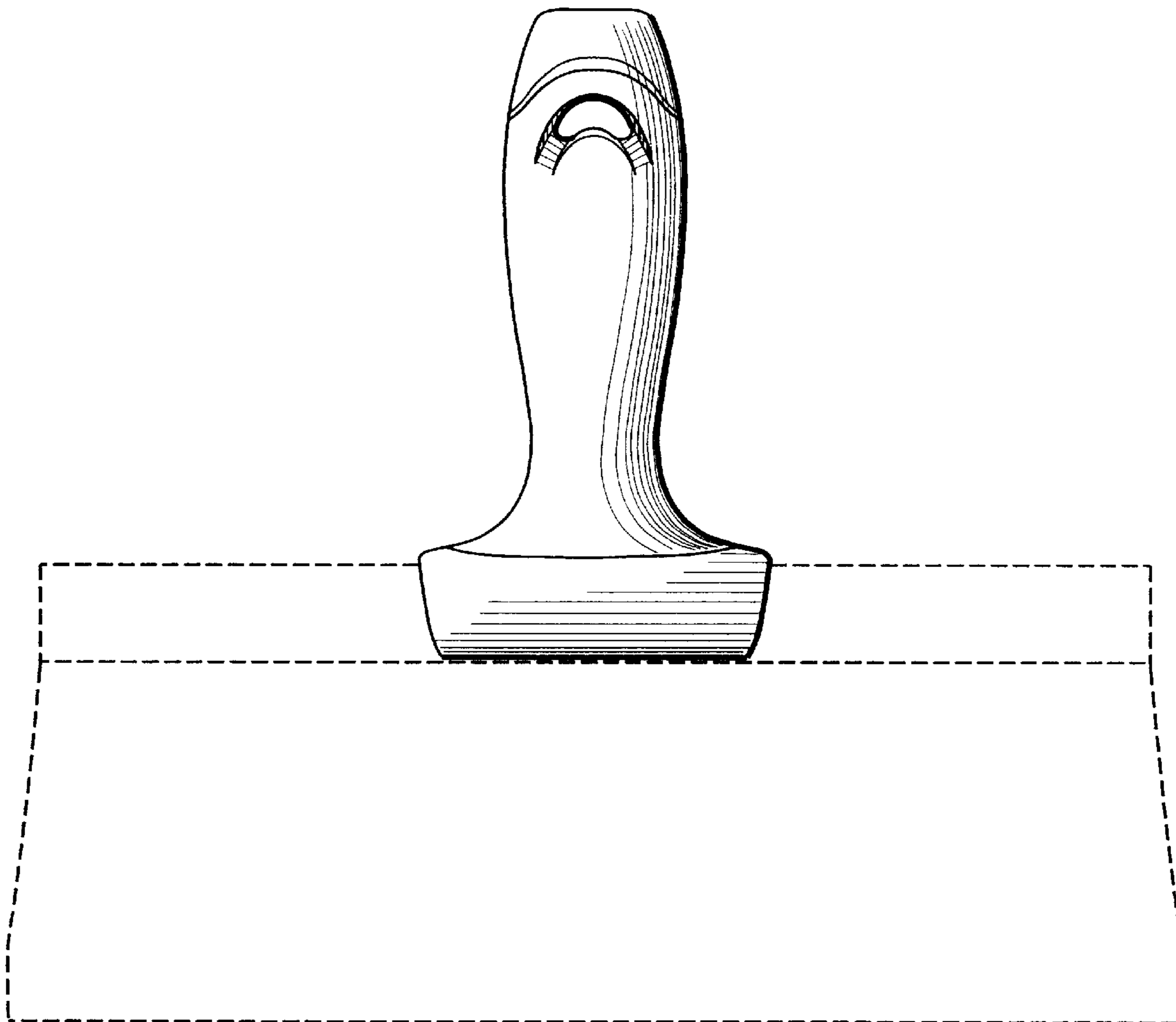

FIG. 7

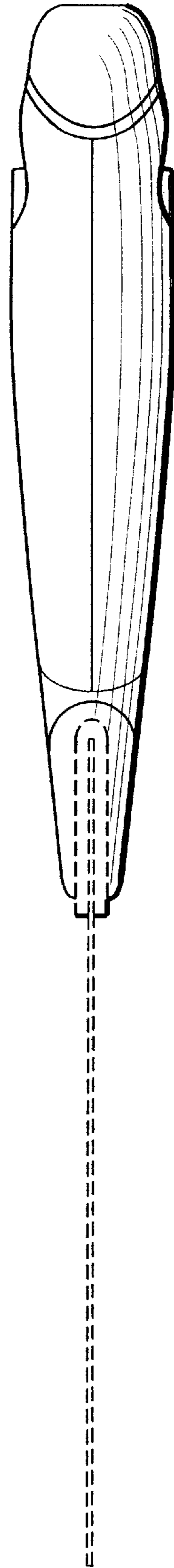

FIG. 8

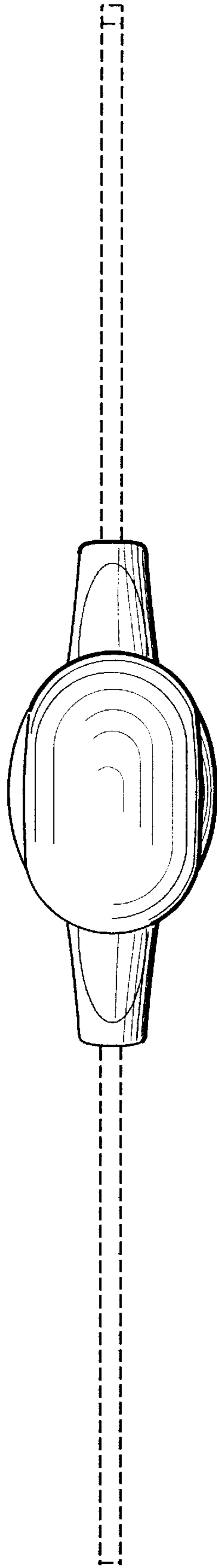

FIG. 9

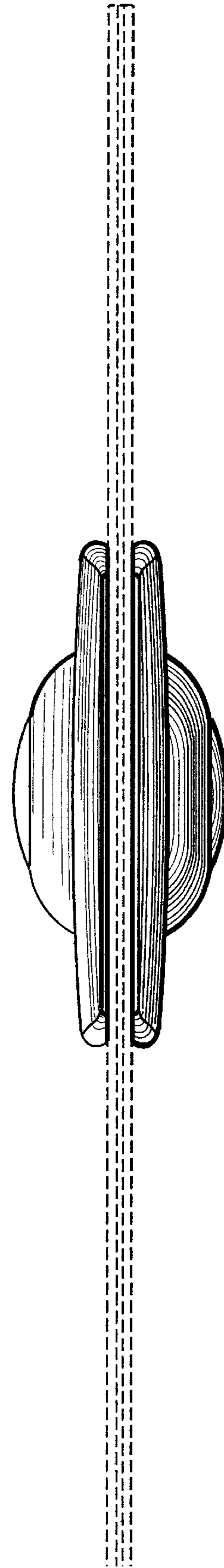

FIG. 10

