



US00D541479S

(12) **United States Design Patent**
Cronin et al.

(10) **Patent No.:** **US D541,479 S**

(45) **Date of Patent:** **** Apr. 24, 2007**

(54) **LIP BALM DISPENSER**

5,727,891 A * 3/1998 Lang 401/68

(75) Inventors: **Ed Cronin**, Brodhead, WI (US); **Alan W Kieler**, Rockford, IL (US); **Gordon E VerWeyst**, Rockford, IL (US)

* cited by examiner

Primary Examiner—Jennifer Rivard

(74) *Attorney, Agent, or Firm*—Reinhart Boerner Van Deuren P.C.

(73) Assignee: **J.L. Clark, Inc.**, Rockford, IL (US)

(**) Term: **14 Years**

(57) **CLAIM**

I claim the ornamental design for the lip balm dispenser, as shown and described.

(21) Appl. No.: **29/234,554**

(22) Filed: **Jul. 20, 2005**

DESCRIPTION

(51) **LOC (8) Cl.** **28-03**

(52) **U.S. Cl.** **D28/90; D9/529; D9/504**

(58) **Field of Classification Search** D28/76,
D28/77, 85–90; 401/68–79; 132/317, 318,
132/320; D9/503–505, 529; 206/385, 823
See application file for complete search history.

FIG. 1 is a perspective view of the lip balm dispenser;
FIG. 2 is a front view of the lip balm dispenser of FIG. 1;
FIG. 3 is a back view of the lip balm dispenser of FIG. 1;
FIG. 4 is a side view of the lip balm dispenser of FIG. 1;
FIG. 5 is a side view of the lip balm dispenser of FIG. 1
showing the side opposite that shown in FIG. 4;
FIG. 6 is an enlarged top view of the lip balm dispenser of
FIG. 1 having a top recessed portion illustrated in dashed
lines; and,
FIG. 7 is an enlarge bottom view of the lip balm dispenser
of FIG. 1 having a bottom recessed portion illustrated in
dashed lines.

The portions shown in dashed lines are for illustrative purposes only and form no part of the claimed design.

(56) **References Cited**

U.S. PATENT DOCUMENTS

3,963,120	A	*	6/1976	Perfect	220/253
4,509,875	A	*	4/1985	Shintani	401/34
4,777,969	A	*	10/1988	Holloway	206/823
D333,014	S		2/1993	Lang		
D389,066	S		1/1998	Lang		
D391,166	S		2/1998	Lang		

1 Claim, 3 Drawing Sheets

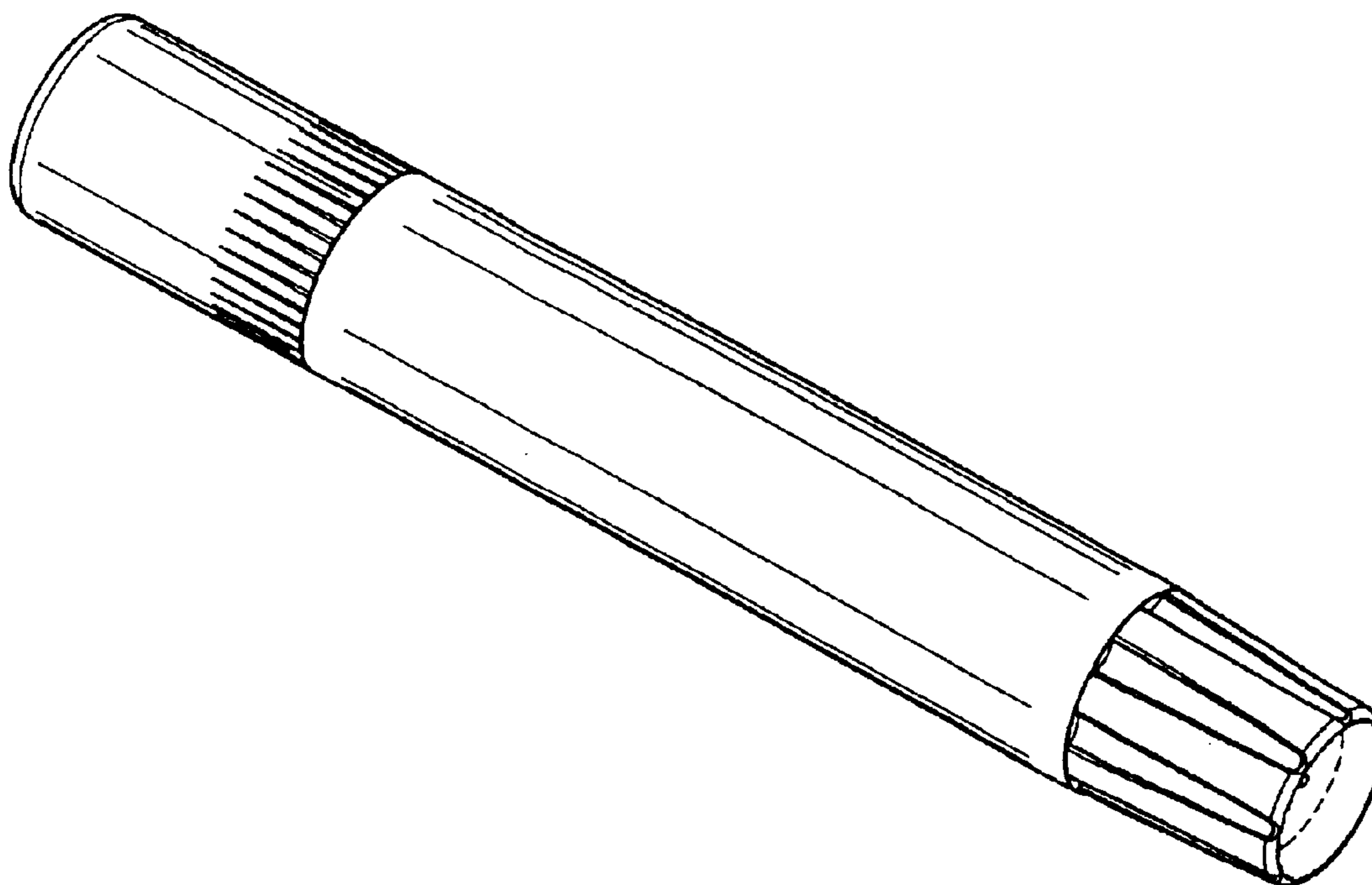

FIG. 1

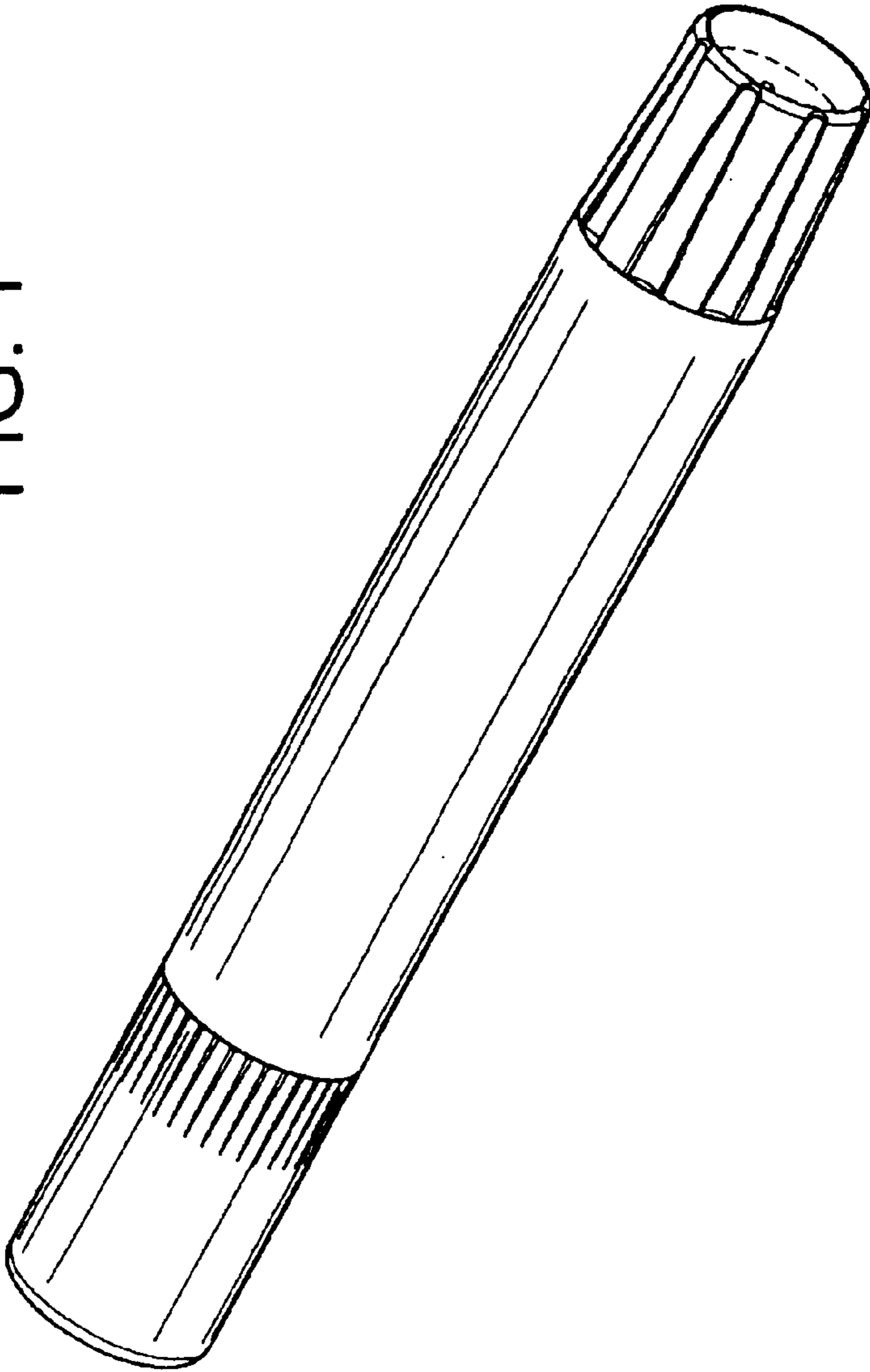

FIG. 2

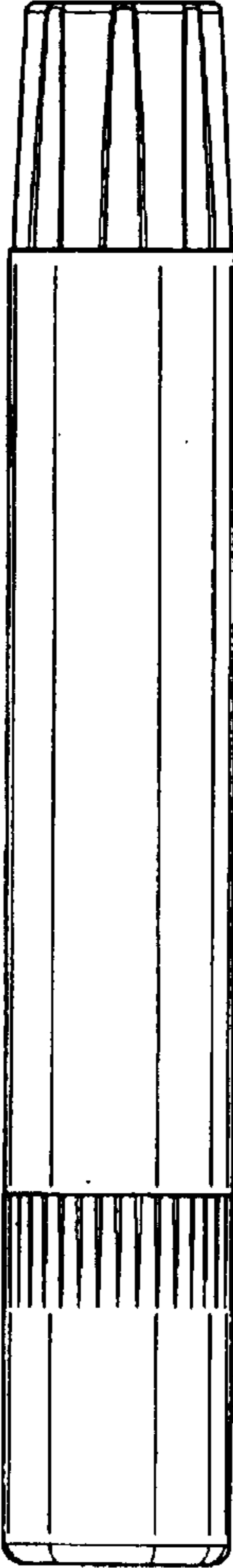

FIG. 3

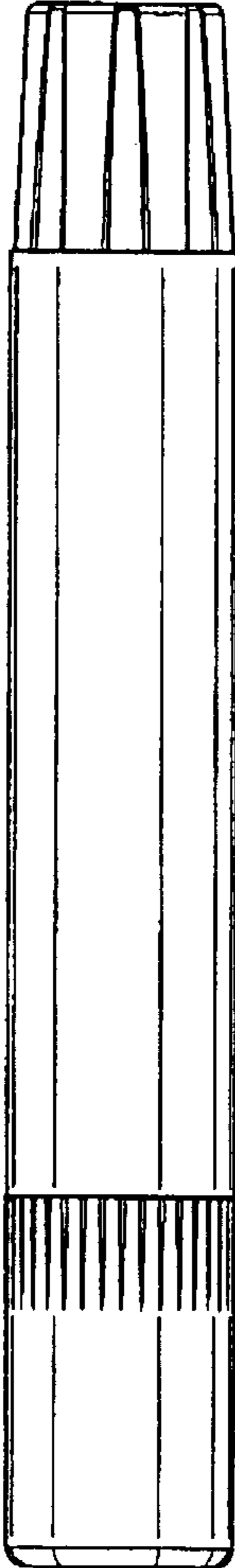

FIG. 4

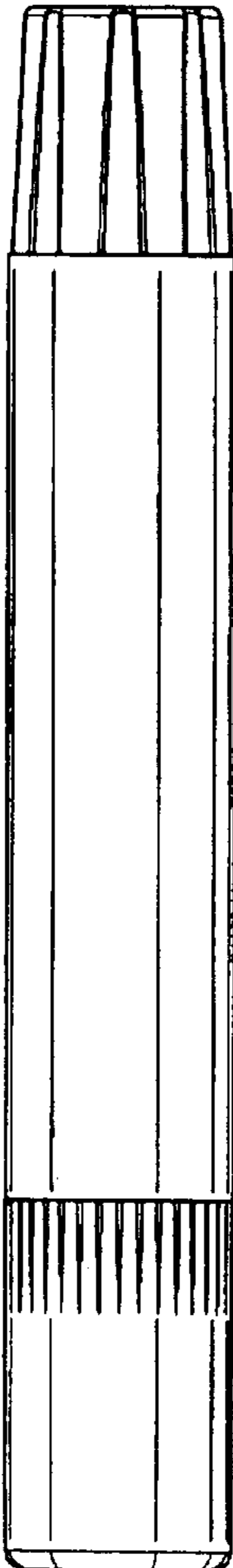

FIG. 5

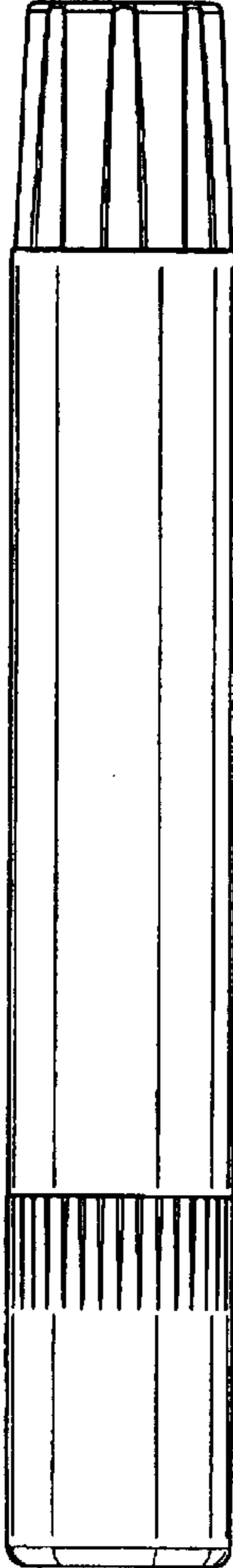

FIG. 7

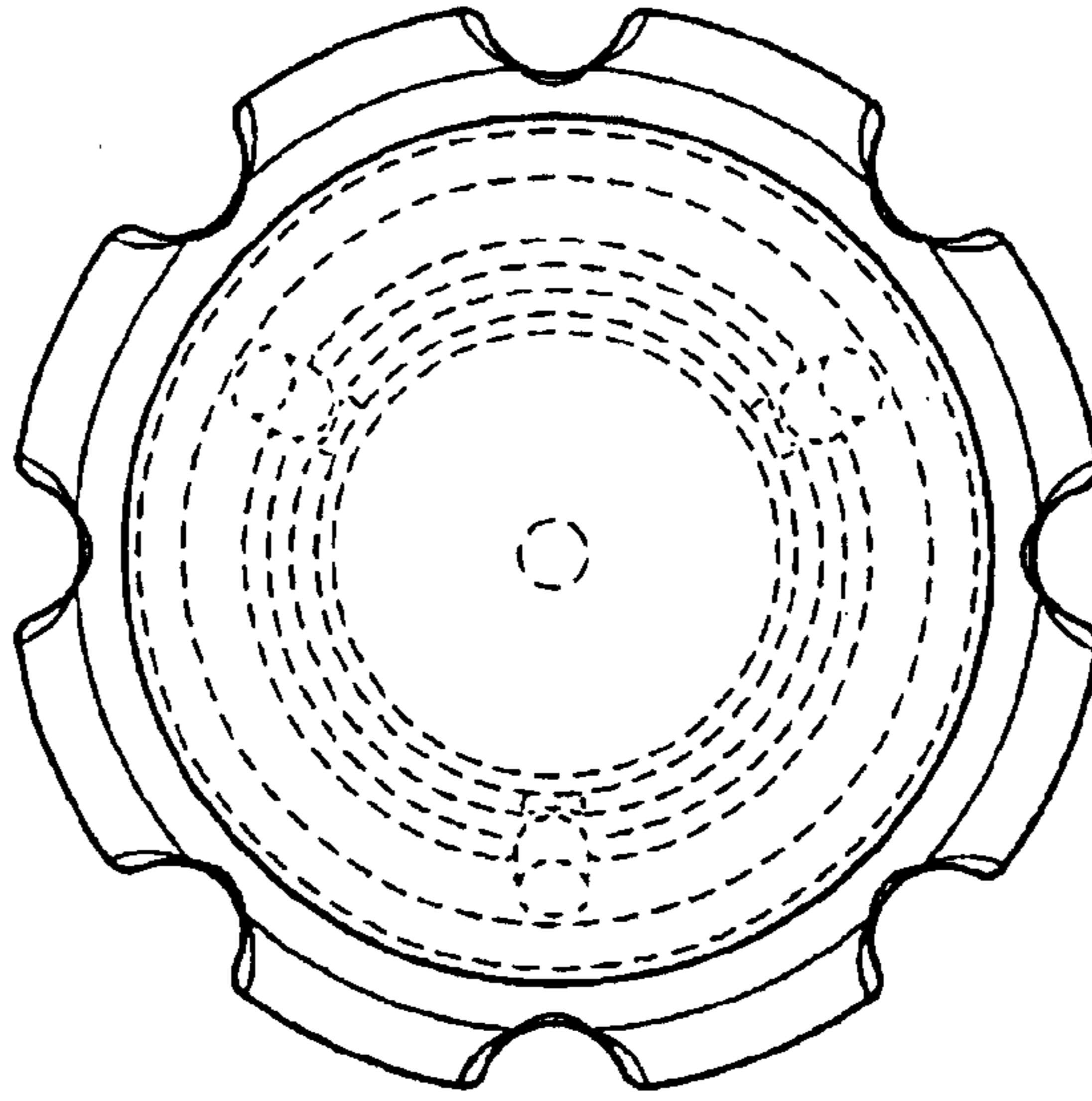

FIG. 6

