

US00D541438S

(12) **United States Design Patent**  
**Dempsey et al.**

(10) **Patent No.: US D541,438 S**

(45) **Date of Patent: \*\* \*Apr. 24, 2007**

(54) **STRUCTURAL BEAM**

D426,320 S \* 6/2000 Andres ..... D25/138  
6,397,550 B1 \* 6/2002 Walker et al. .... 52/653.1

(75) Inventors: **Ross Ian Dempsey**, Calamvale (AU);  
**Russell Lambert Watkins**, Coorparoo (AU)

\* cited by examiner

(73) Assignee: **Smorgon Steel LiteSteel Products Pty Ltd**, Victoria (AU)

*Primary Examiner*—Doris Clark  
(74) *Attorney, Agent, or Firm*—Holme Roberts & Owen, LLP

(\*) Notice: This patent is subject to a terminal disclaimer.

(57) **CLAIM**

(\*\*) Term: **14 Years**

The ornamental design for a structural beam, as shown and described.

(21) Appl. No.: **29/224,366**

**DESCRIPTION**

(22) Filed: **Mar. 1, 2005**

(30) **Foreign Application Priority Data**

Sep. 3, 2004 (AU) ..... 14234/2004

(51) **LOC (8) Cl.** ..... **25-01**

(52) **U.S. Cl.** ..... **D25/122**

(58) **Field of Classification Search** ..... D25/122,  
D25/126; 52/433, 461, 465, 650.1, 716.1,  
52/726.2, 731.2, 732.1, 724.1, 653.1; 428/121,  
428/122, 126, 131, 221  
See application file for complete search history.

FIG. 1 is a front view of a structural beam;  
FIG. 2 is a first end view of the structural beam of FIG. 1;  
FIG. 3 is a back view of the structural beam of FIG. 1;  
FIG. 4 is a second end view of the structural beam of FIG. 1;  
FIG. 5 is a first side view of the structural beam of FIG. 1;  
FIG. 6 is a second side view of the structural beam of FIG. 1;  
FIG. 7 is a first perspective view of the structural beam of FIG. 1; and,  
FIG. 8 is a second perspective view of the structural beam of FIG. 1.

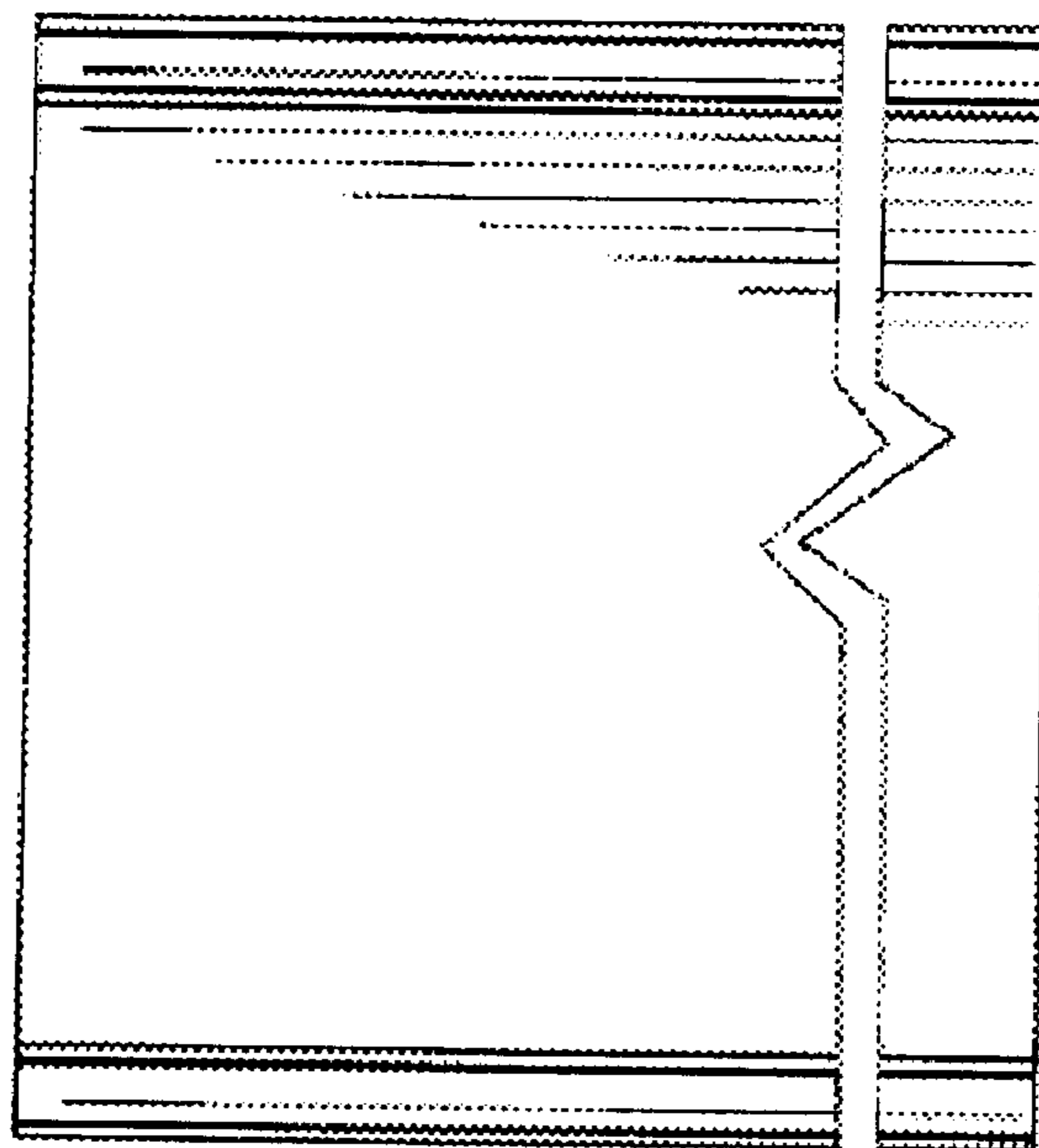
The claimed design has been broken near one end to indicate indeterminate length.

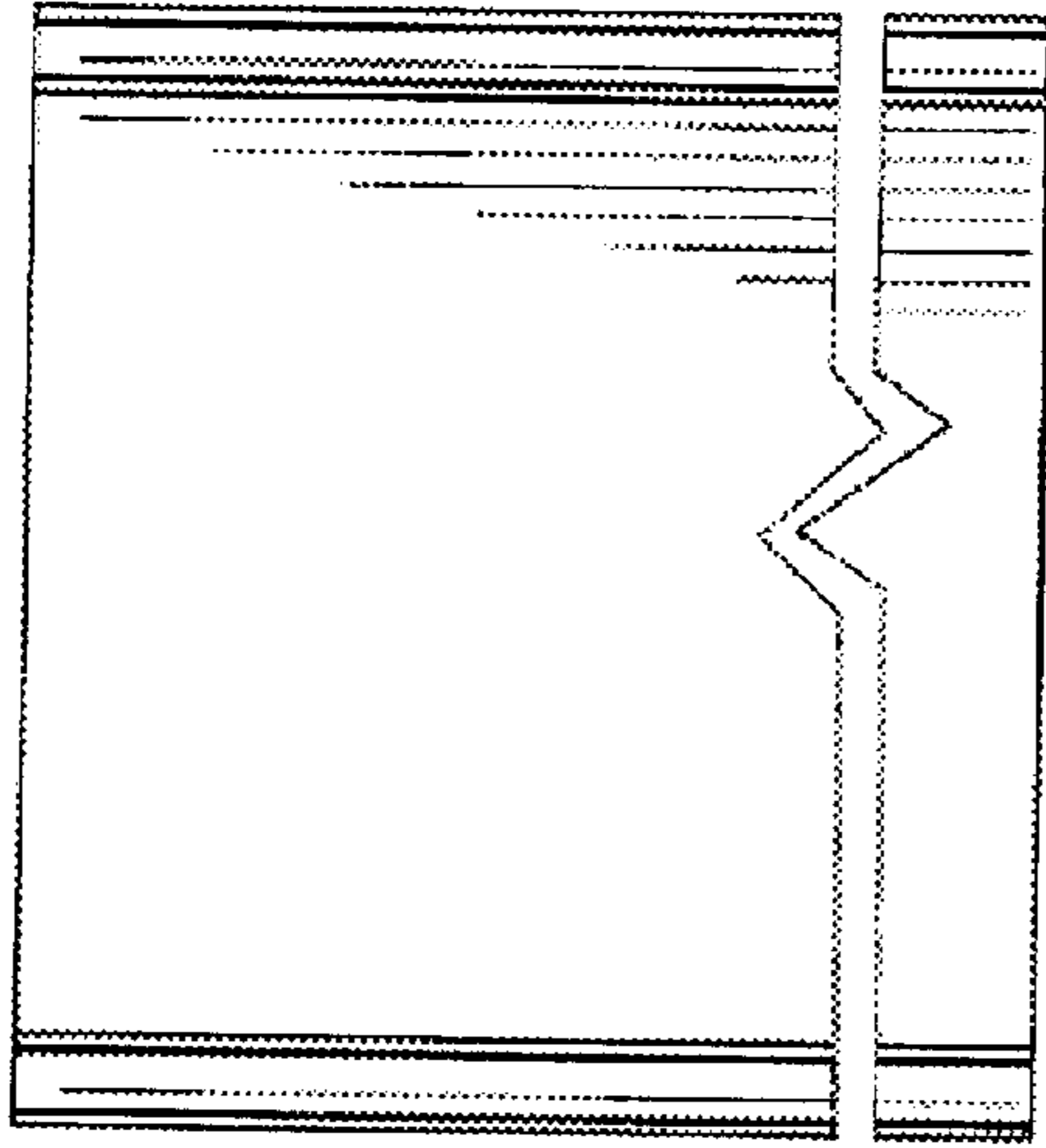
(56) **References Cited**

**U.S. PATENT DOCUMENTS**

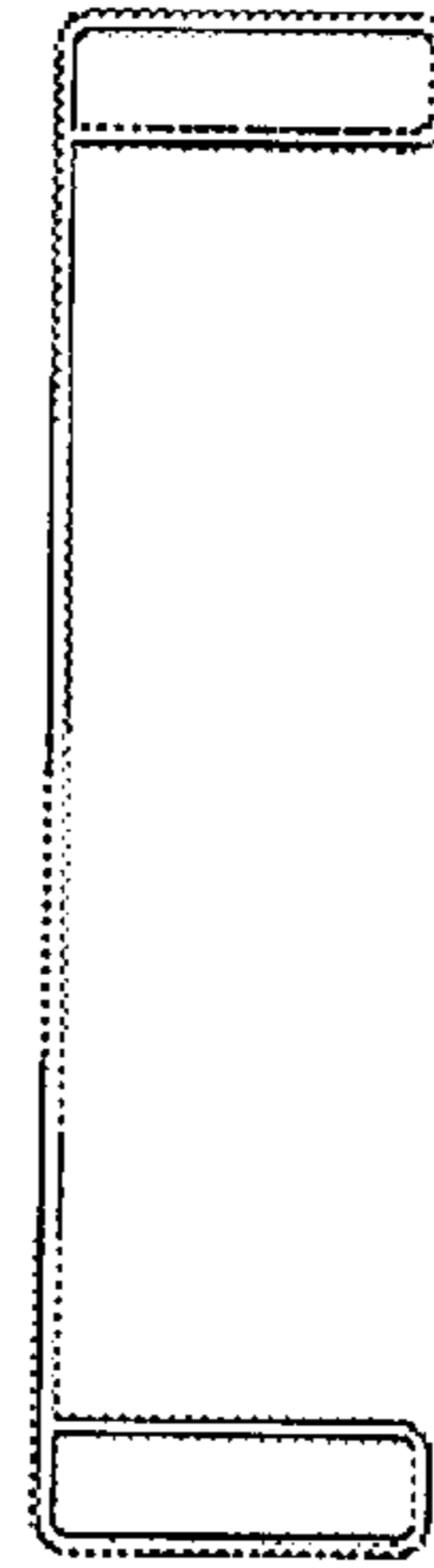
D291,832 S \* 9/1987 Lundstrom ..... D25/122

**1 Claim, 2 Drawing Sheets**

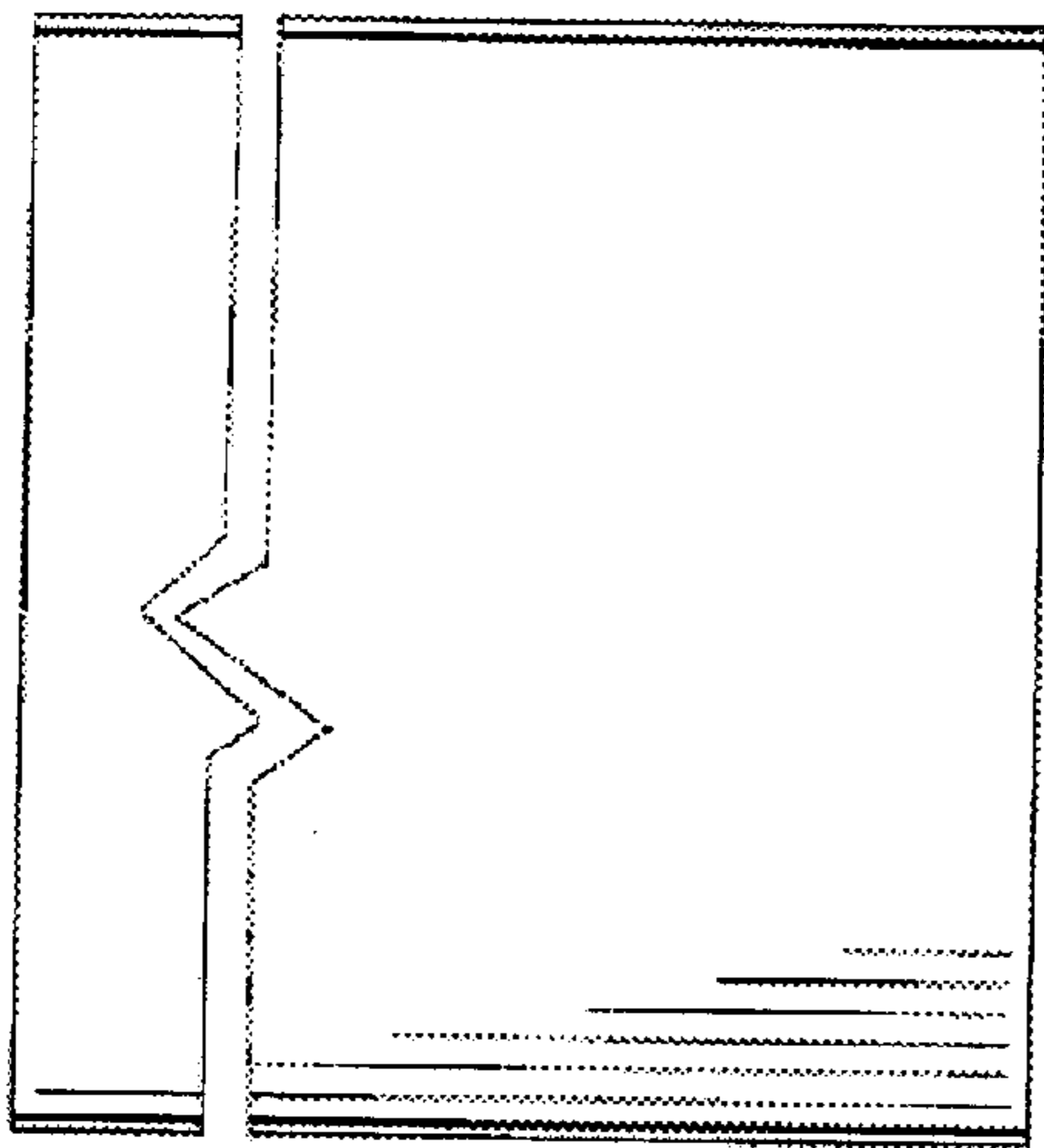




**Fig. 1**



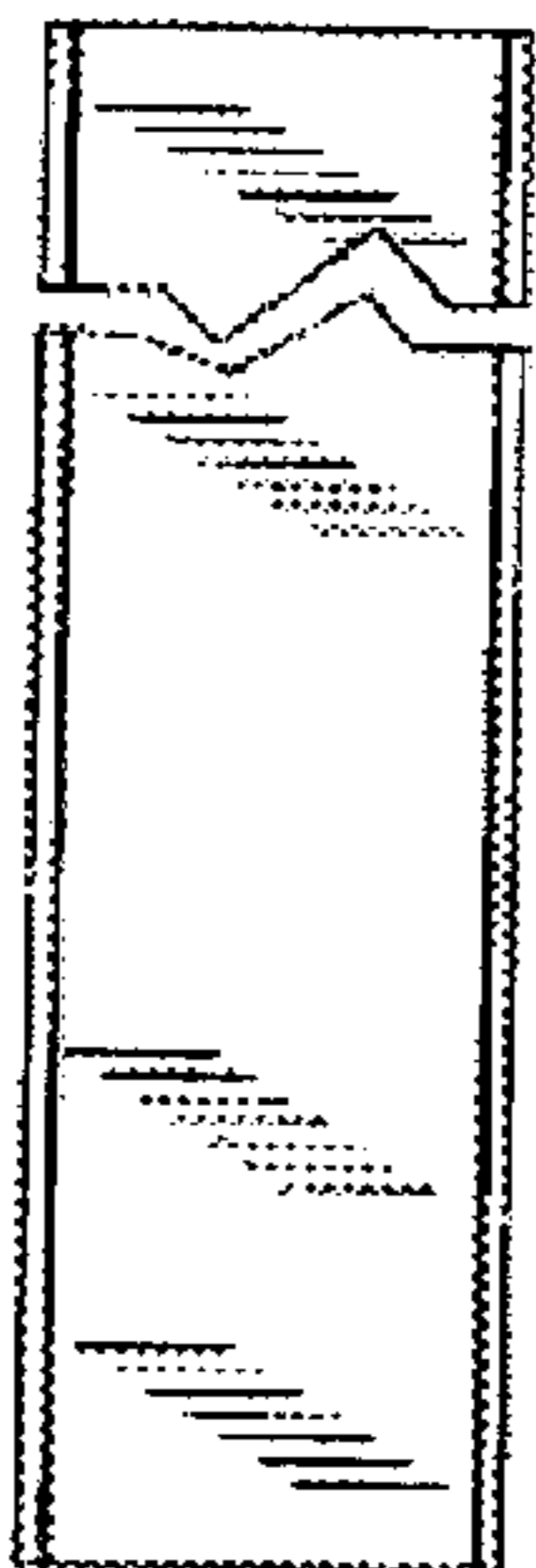
**Fig. 2**



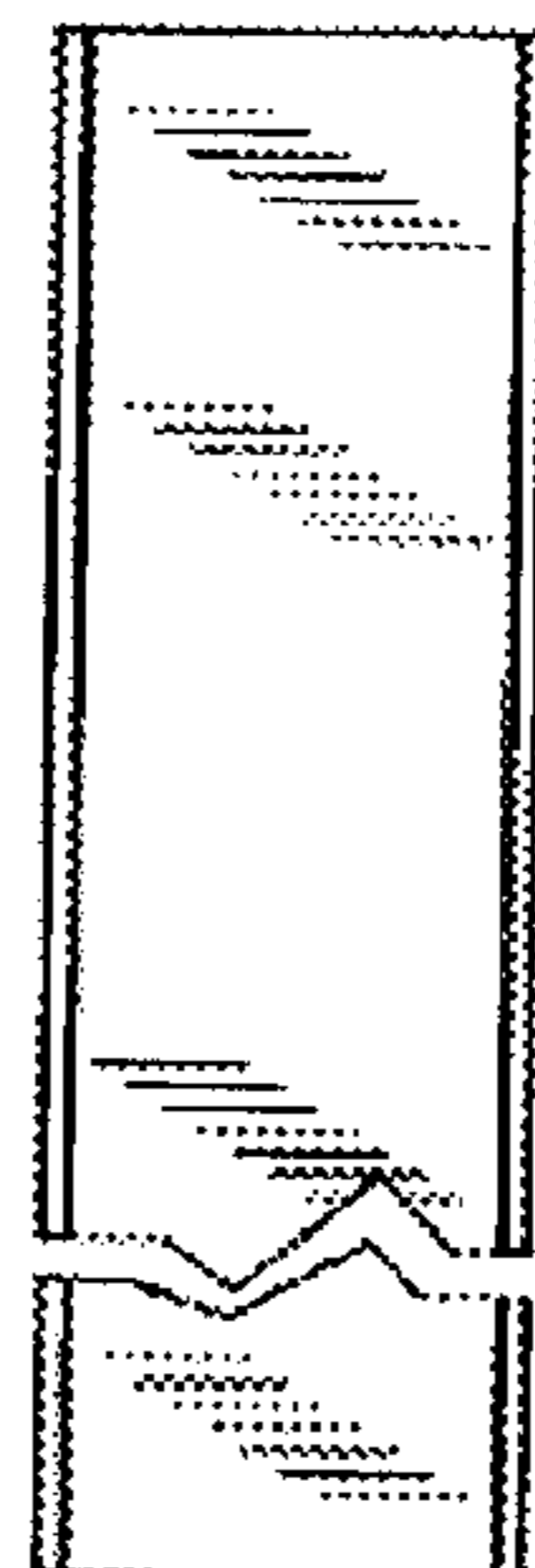
**Fig. 3**



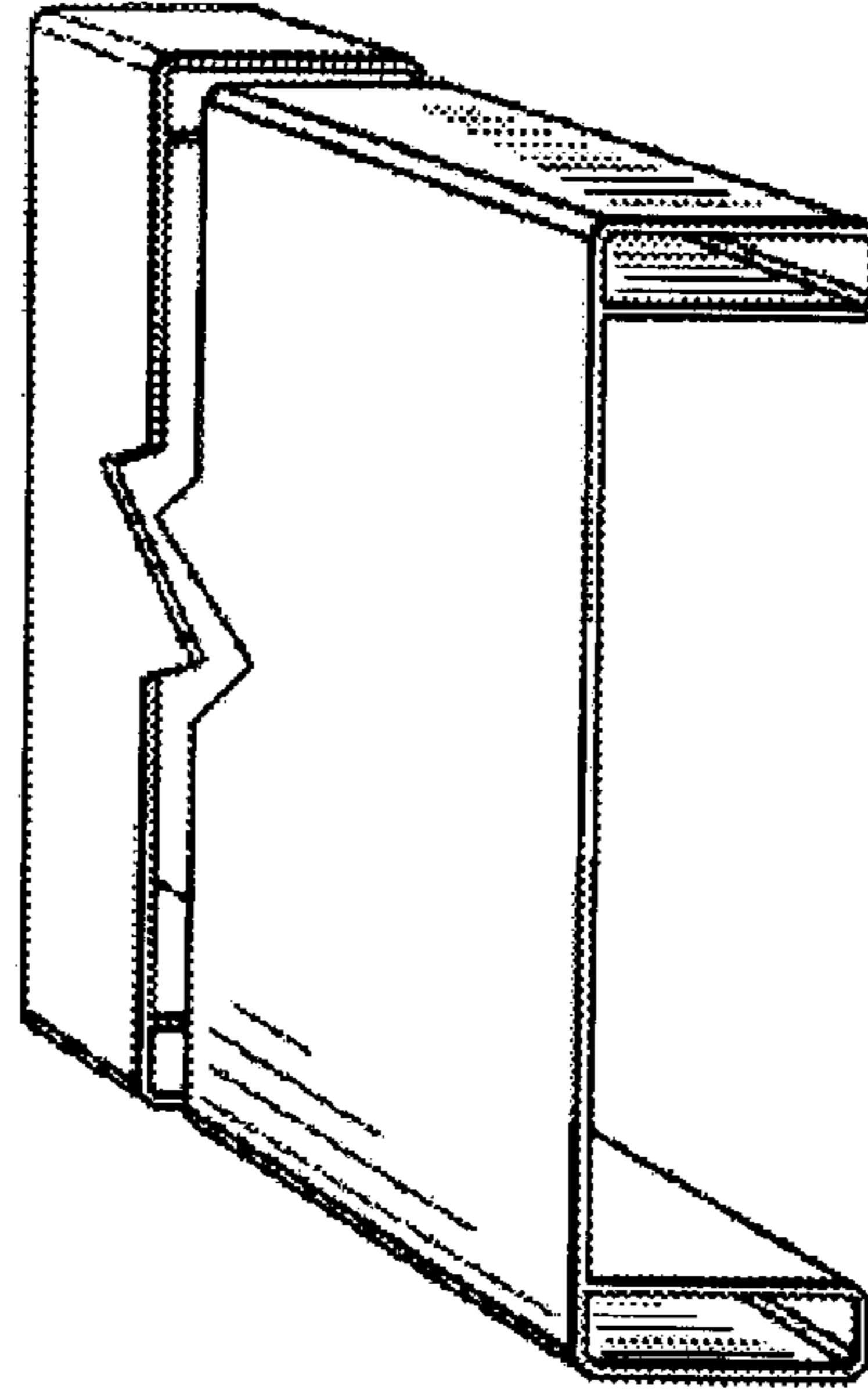
**Fig. 4**



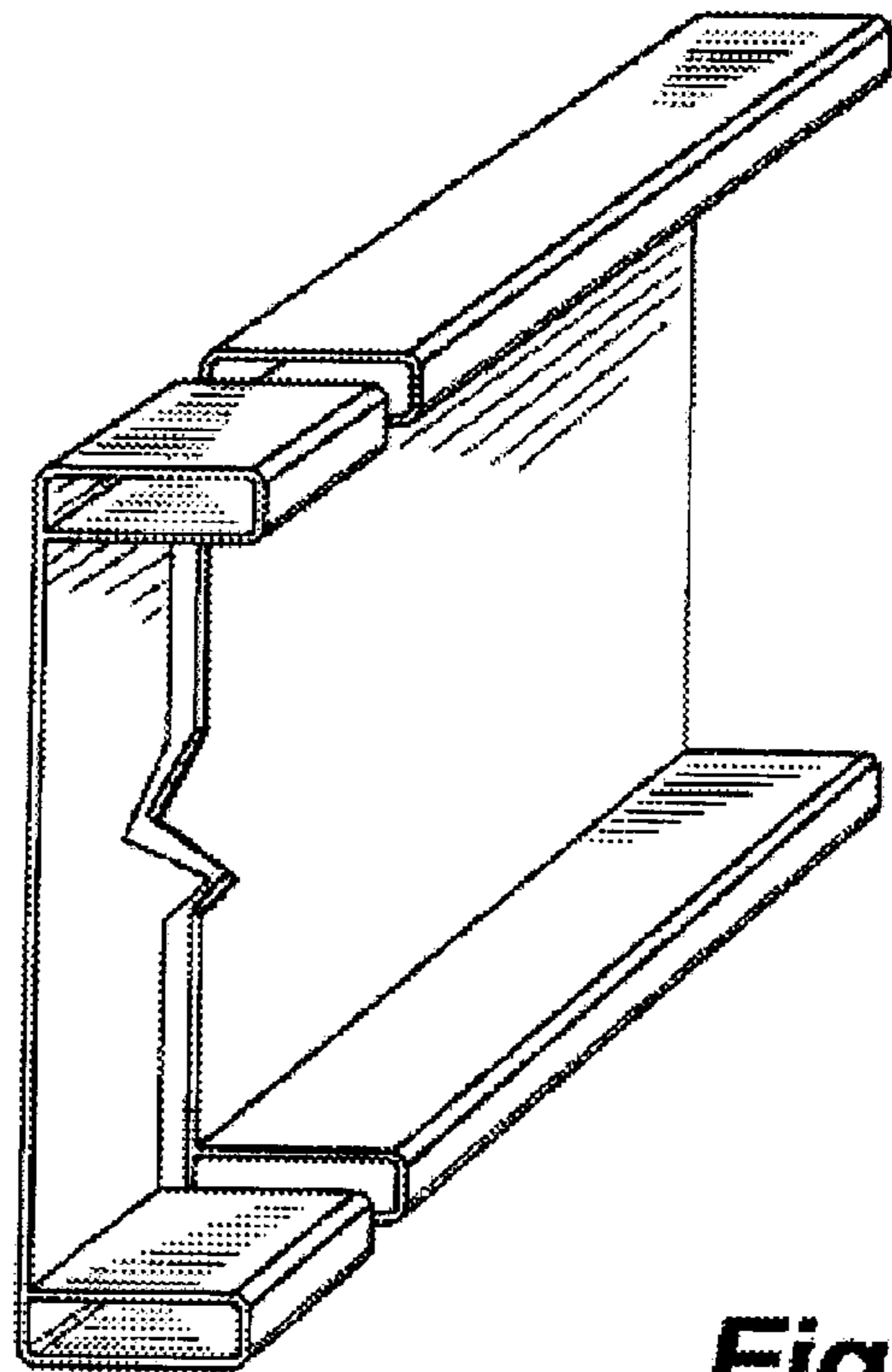
**Fig. 5**



**Fig. 6**



**Fig. 7**



**Fig. 8**