



US00D541432S

(12) **United States Design Patent**  
**Rapp**

(10) **Patent No.:** **US D541,432 S**

(45) **Date of Patent:** **\*\* Apr. 24, 2007**

(54) **STORAGE UNIT FOR LADDER**

*Primary Examiner—Doris Clark*

(76) Inventor: **Carl W. Rapp**, 7556 Clider Ave.,  
Hesperia, CA (US) 92345

(57) **CLAIM**

I claim the ornamental design for a storage unit for ladder,  
as shown.

(\*\*) Term: **14 Years**

(21) Appl. No.: **29/231,880**

**DESCRIPTION**

(22) Filed: **Jun. 13, 2005**

(51) **LOC (8) Cl.** ..... **25-04**

(52) **U.S. Cl.** ..... **D25/68**

(58) **Field of Classification Search** ..... D25/68,  
D25/69; 248/236, 210

See application file for complete search history.

A visually appealing storage unit for ladders with removable  
storage trays for small tools, fasteners and miscellaneous  
work supplies contained on a large platform, with multiple  
holes in the side of the unit for inserting ropes or chains for  
the purpose of balancing.

FIG. 1 is a front perspective view showing my design;

FIG. 2 is a back view;

FIG. 3 is a right side view;

FIG. 4 is a top view;

FIG. 5 is a bottom view;

FIG. 6 is an perspective view; and,

FIG. 7 is another perspective view showing the storage unit  
for a ladder.

The broken lines showing a ladder is for illustrative pur-  
poses only and forms no part of the claimed design.

(56) **References Cited**

**U.S. PATENT DOCUMENTS**

D286,574 S	11/1986	McMillin	
5,370,263 A	12/1994	Brown	
5,603,405 A	2/1997	Smith	
5,782,314 A	7/1998	Zeitler	
5,901,998 A	5/1999	Gallo, Jr.	
5,913,380 A	6/1999	Gugel	
5,941,344 A	8/1999	Spadaro	
D418,612 S	* 1/2000	Deutsch	..... D25/68
D434,856 S	* 12/2000	Yahner	..... D25/68

\* cited by examiner

**1 Claim, 7 Drawing Sheets**

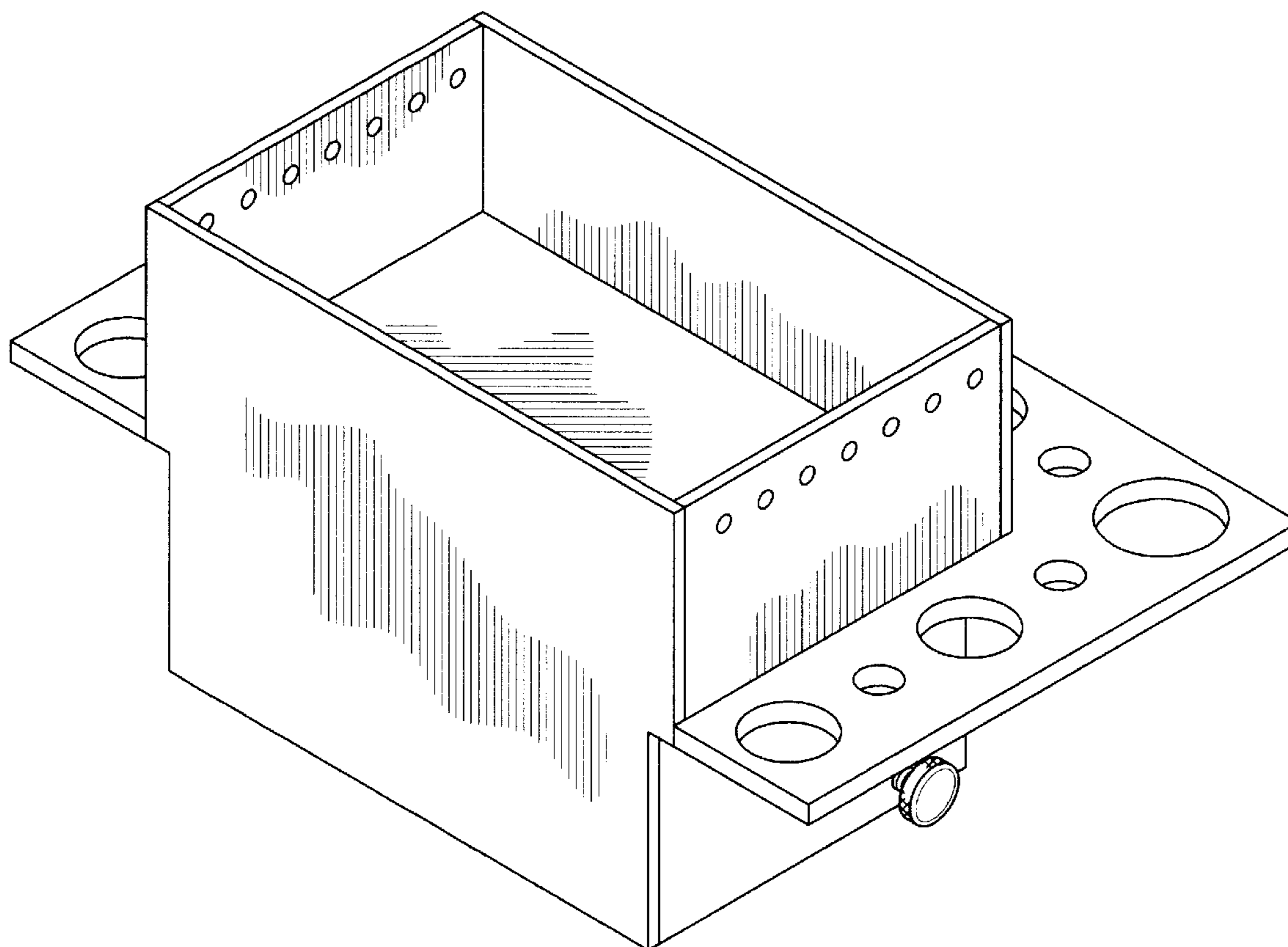

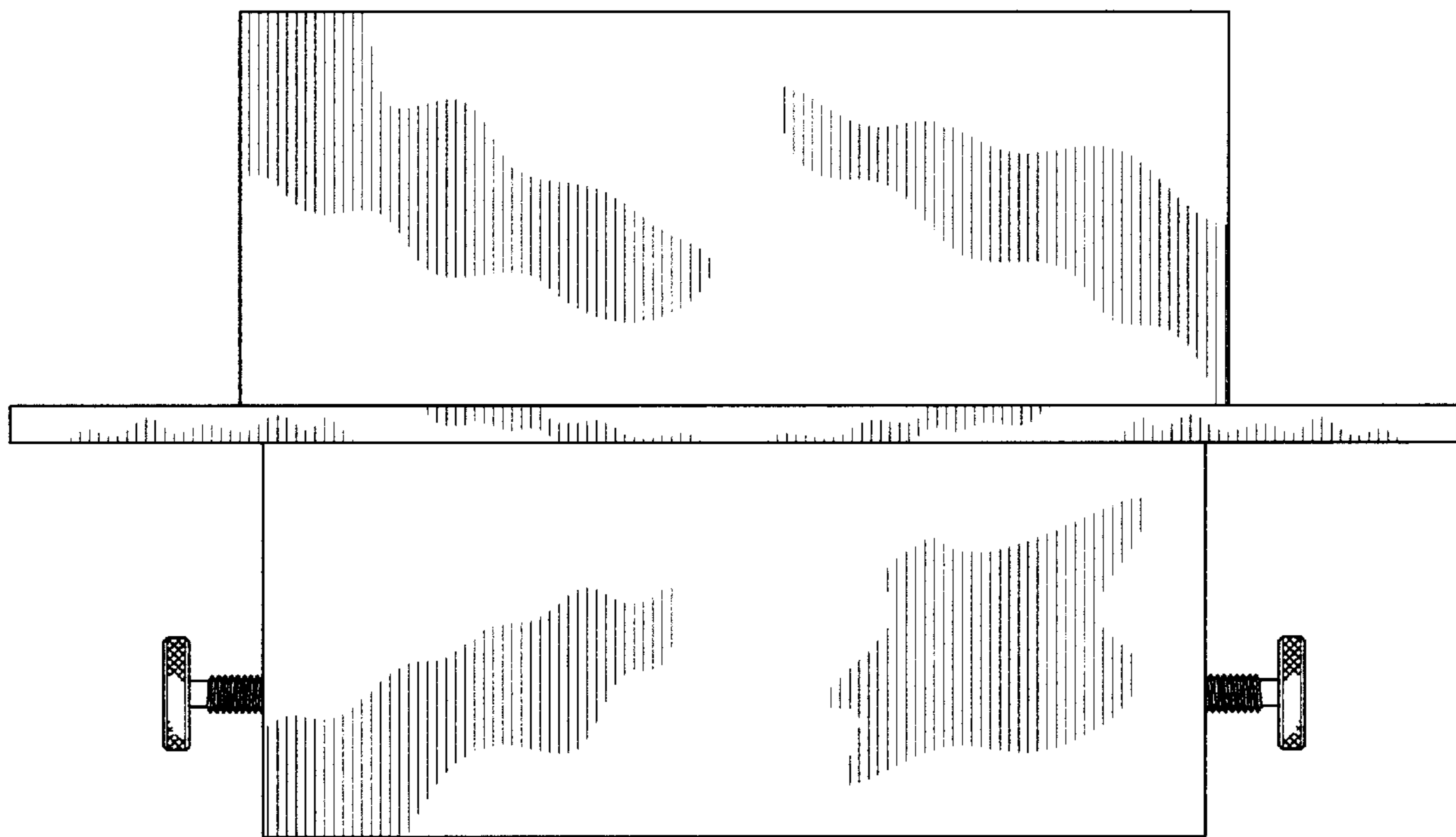

FIG.1

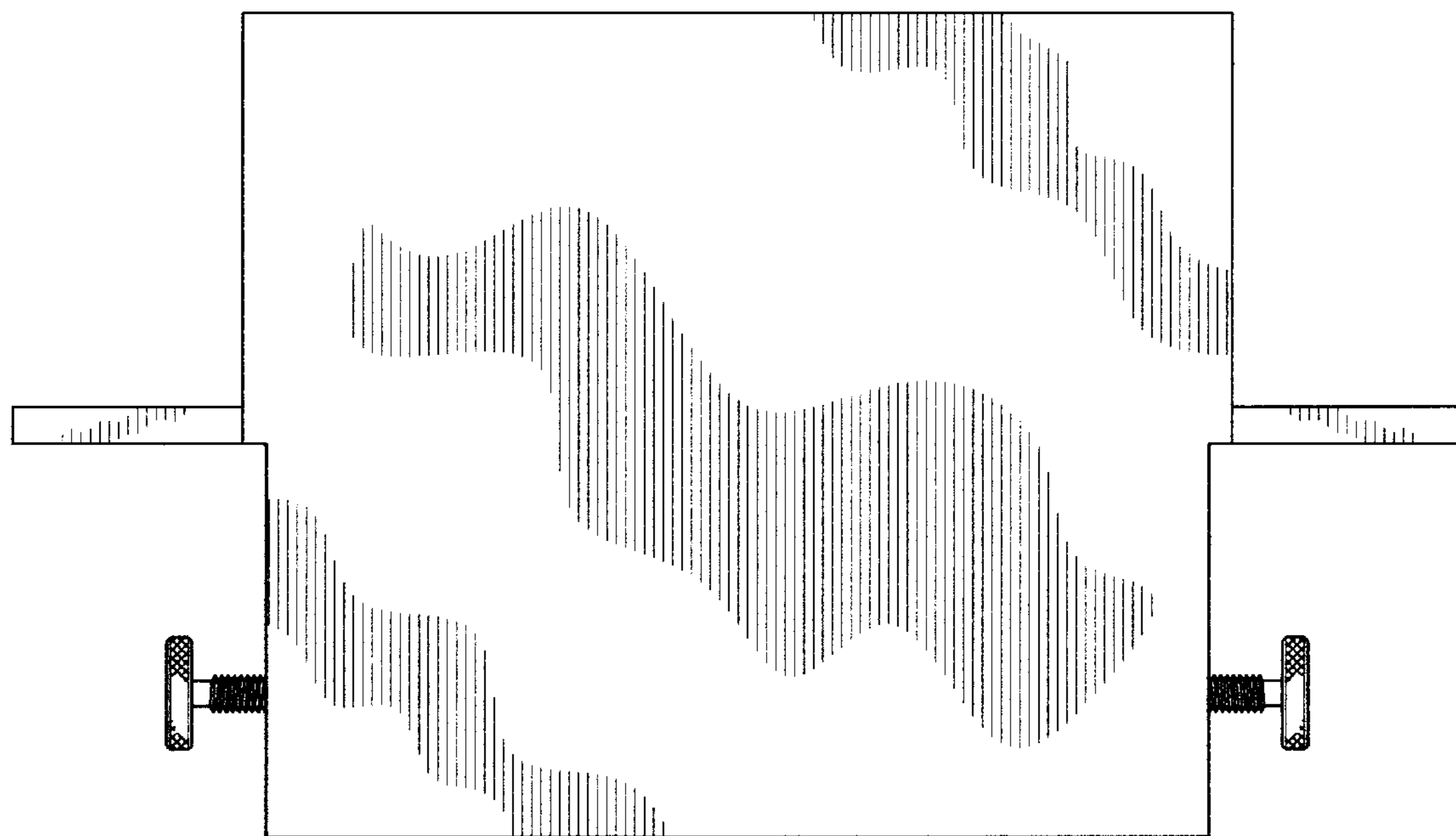

FIG.2

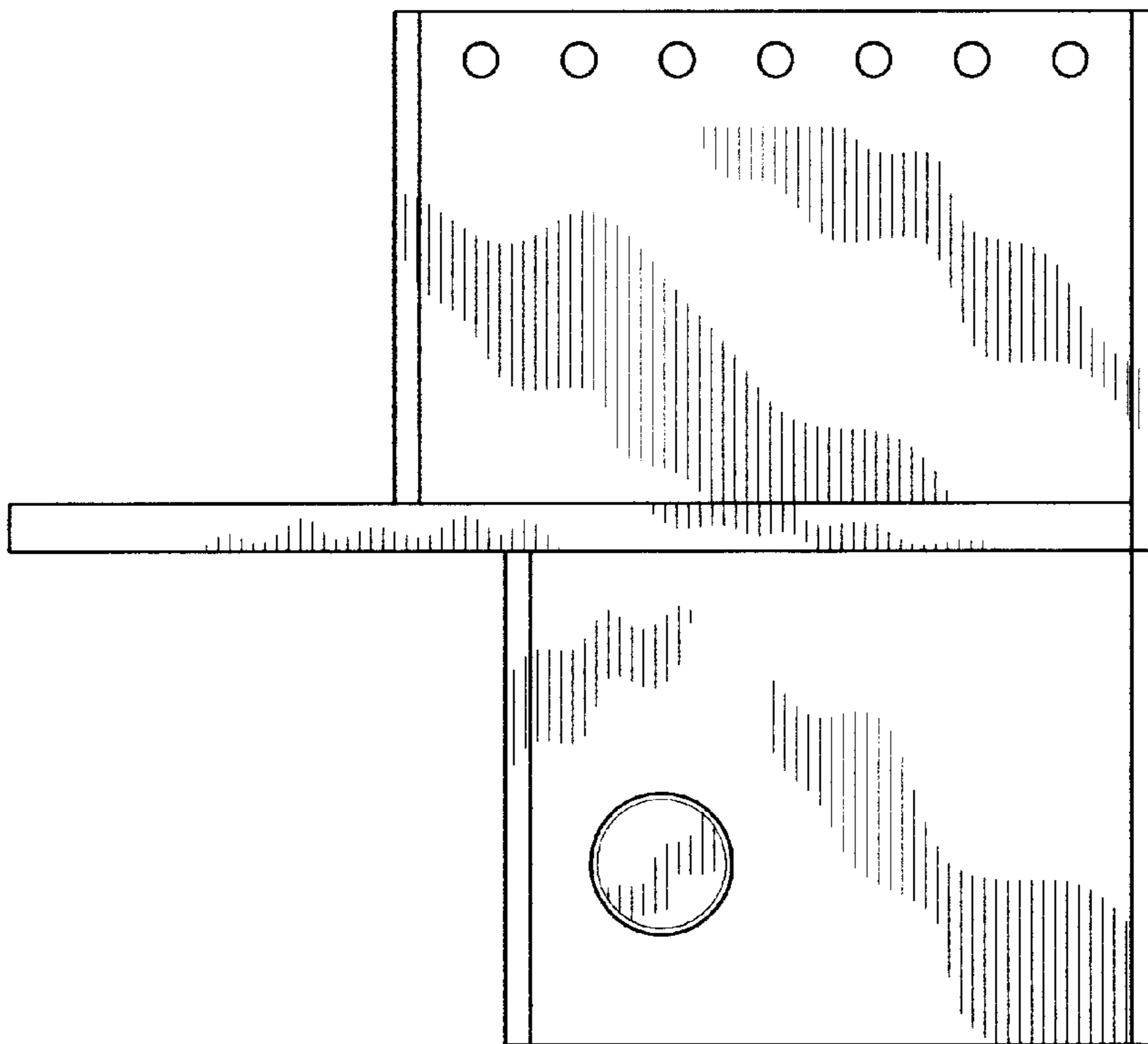

FIG.3

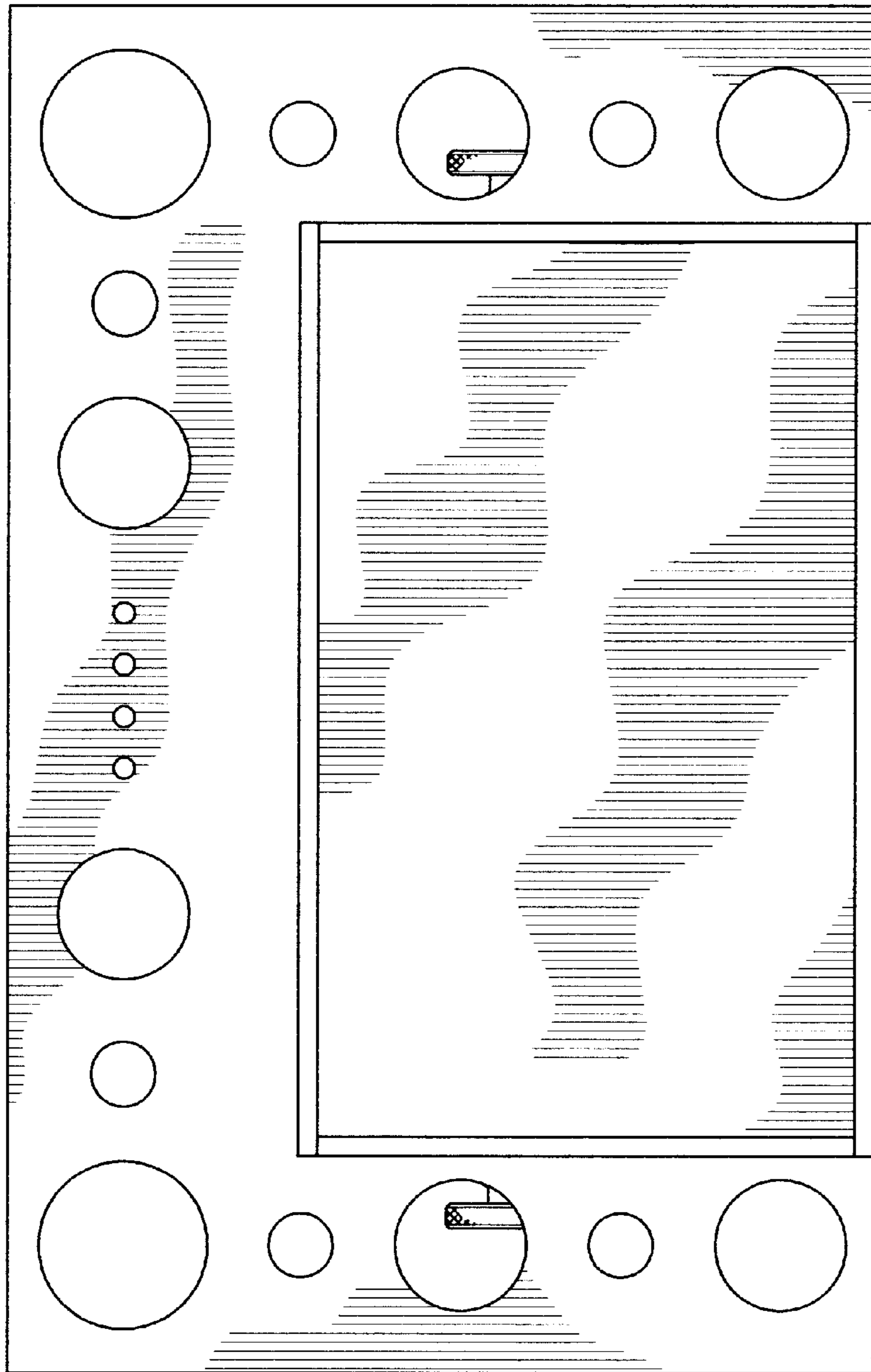

FIG.4

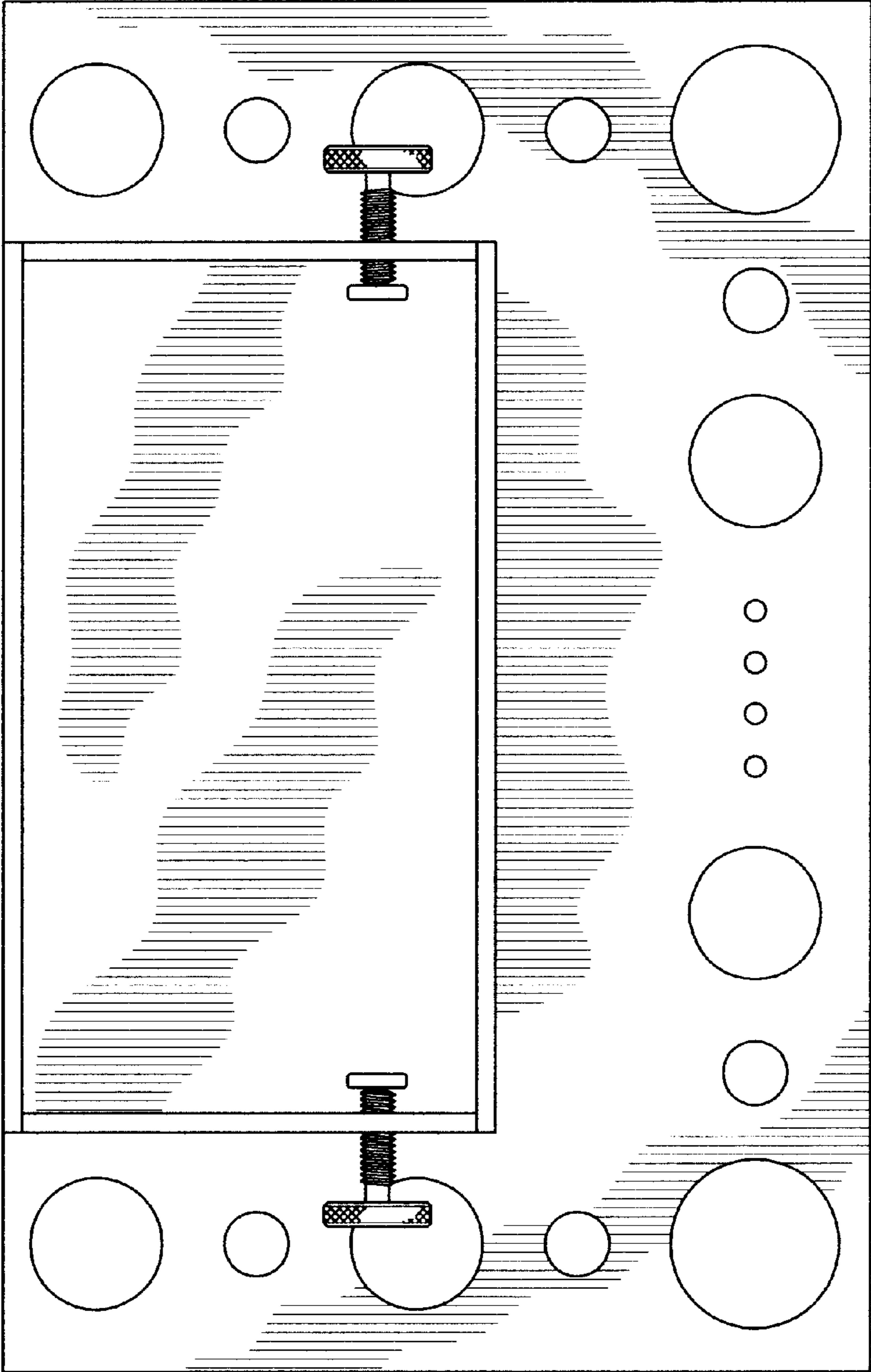

FIG.5

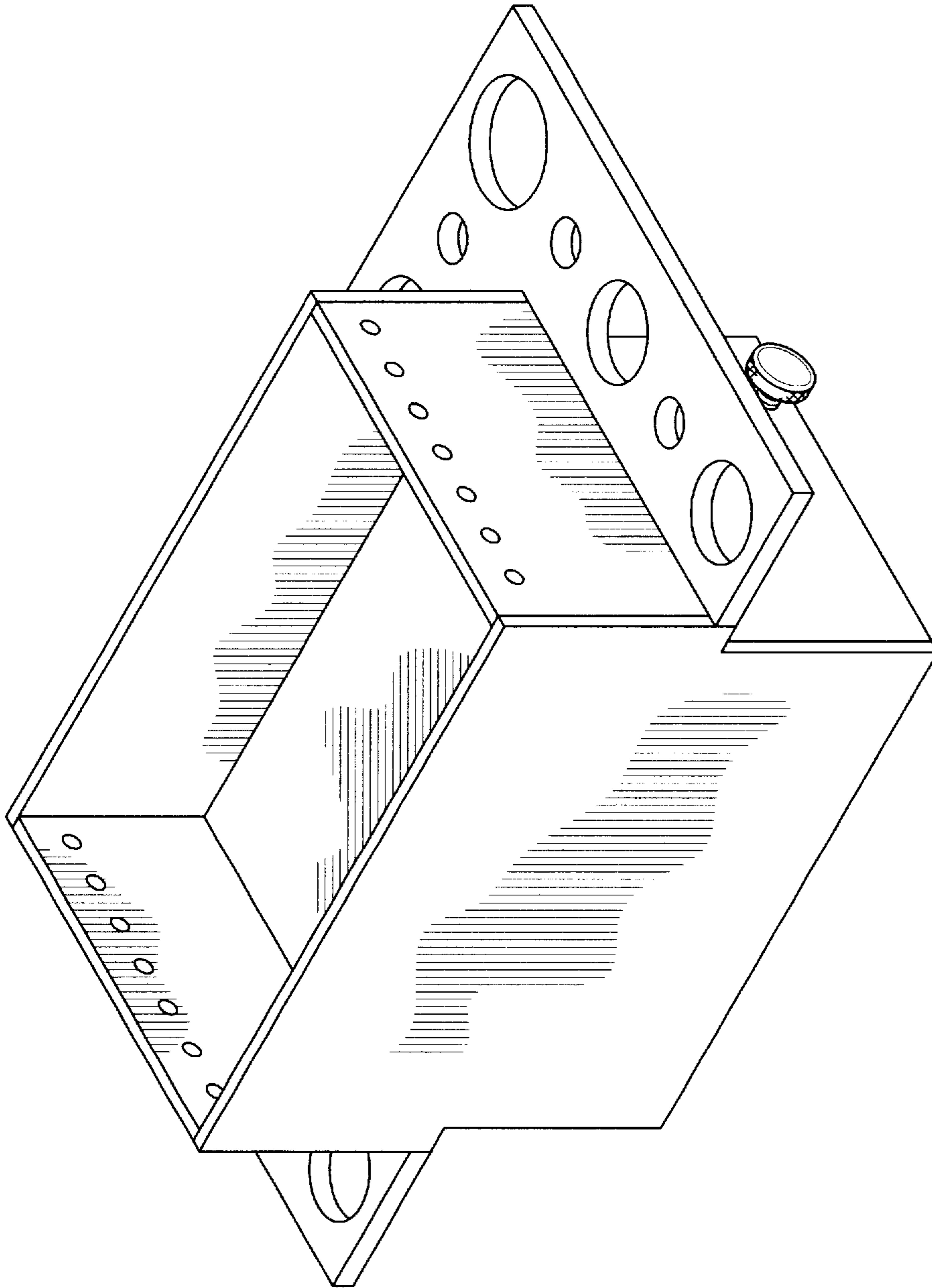

FIG.6

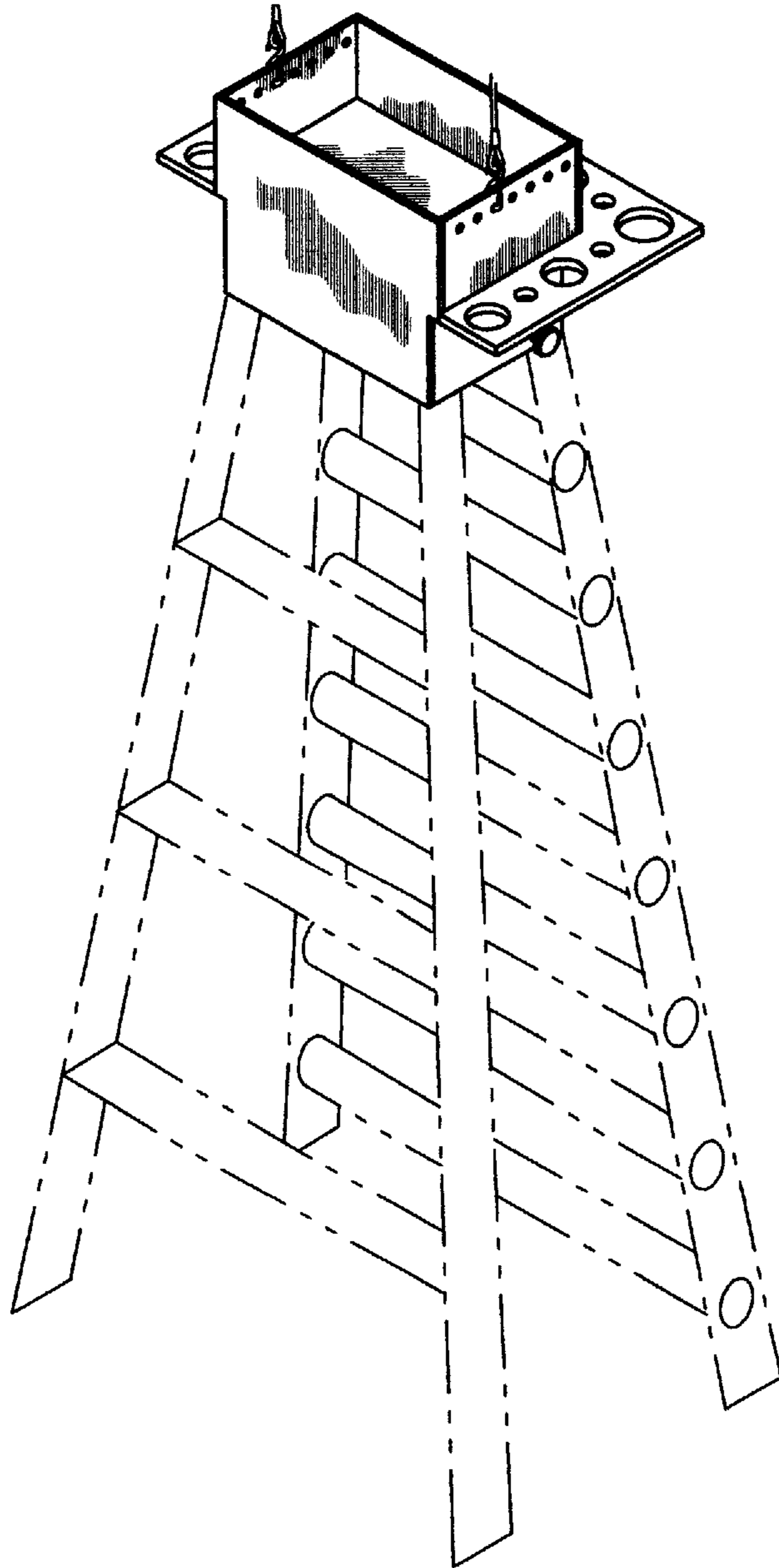

FIG.7