



US00D541429S

(12) **United States Design Patent**  
**Horden**

(10) **Patent No.:** **US D541,429 S**

(45) **Date of Patent:** **\*\* Apr. 24, 2007**

(54) **MICRO COMPACT HOME**

(76) Inventor: **Richard Horden**, 34, Bruton Place,  
London (GB), W1J 6NR

(\*\*) Term: **14 Years**

(21) Appl. No.: **29/240,568**

(22) Filed: **Oct. 14, 2005**

(51) **LOC (8) Cl.** ..... **25-03**

(52) **U.S. Cl.** ..... **D25/33**

(58) **Field of Classification Search** ..... D25/1,  
D25/33; 52/79.1

See application file for complete search history.

(56) **References Cited**

**U.S. PATENT DOCUMENTS**

D257,538 S	*	11/1980	Berman	.....	D25/33
5,036,634 A	*	8/1991	Lessard et al.	.....	52/79.1
5,481,837 A	*	1/1996	Minks, Jr.	.....	52/169.6
6,862,847 B2	*	3/2005	Bigelow	.....	52/79.1
6,981,347 B1	*	1/2006	Walburger	.....	52/79.1

\* cited by examiner

*Primary Examiner*—Doris Clark

(74) *Attorney, Agent, or Firm*—Brinks Hofer Gilson & Lione

(57) **CLAIM**

I claim the ornamental design for a micro compact home, as shown and described.

**DESCRIPTION**

FIG. 1 is a front elevation view of a micro compact home of the present invention.

FIG. 2 is an elevation view of the left side of the micro compact home shown in FIG. 1.

FIG. 3 is an elevation view of the right side of the micro compact home shown in FIG. 1.

FIG. 4 is a back elevation view of the micro compact home shown in FIG. 1.

FIG. 5 is a top plan view of the micro compact home shown in the prior Figures; and,

FIG. 6 is a perspective view from the upper right of FIG. 1 of the micro compact home shown in the prior Figures.

No claim of design is made with respect to the bottom of the micro compact home shown in the prior Figures.

The broken lines shown in the drawings are for illustrative purposes only and form no part of the claimed design.

**1 Claim, 6 Drawing Sheets**

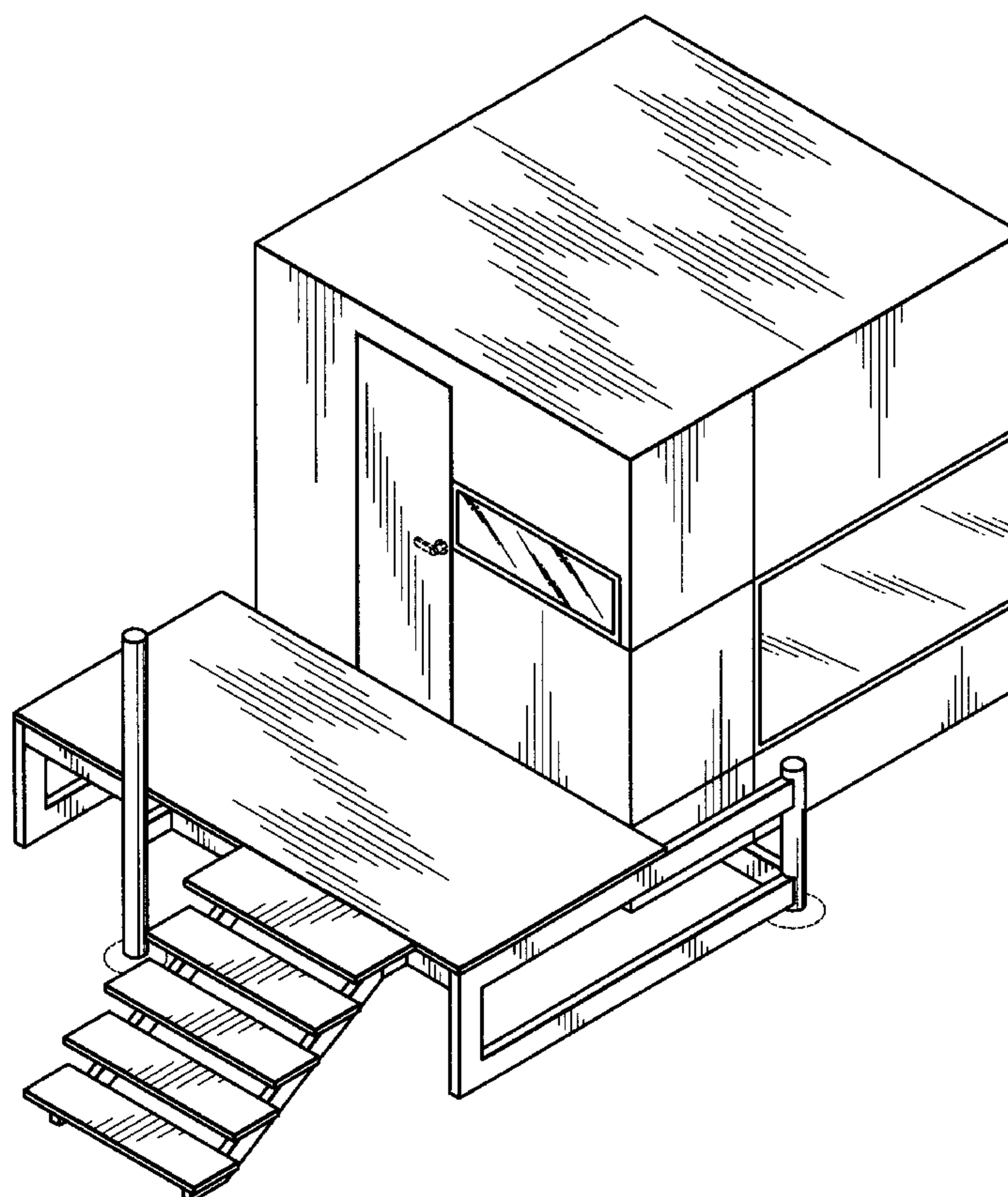

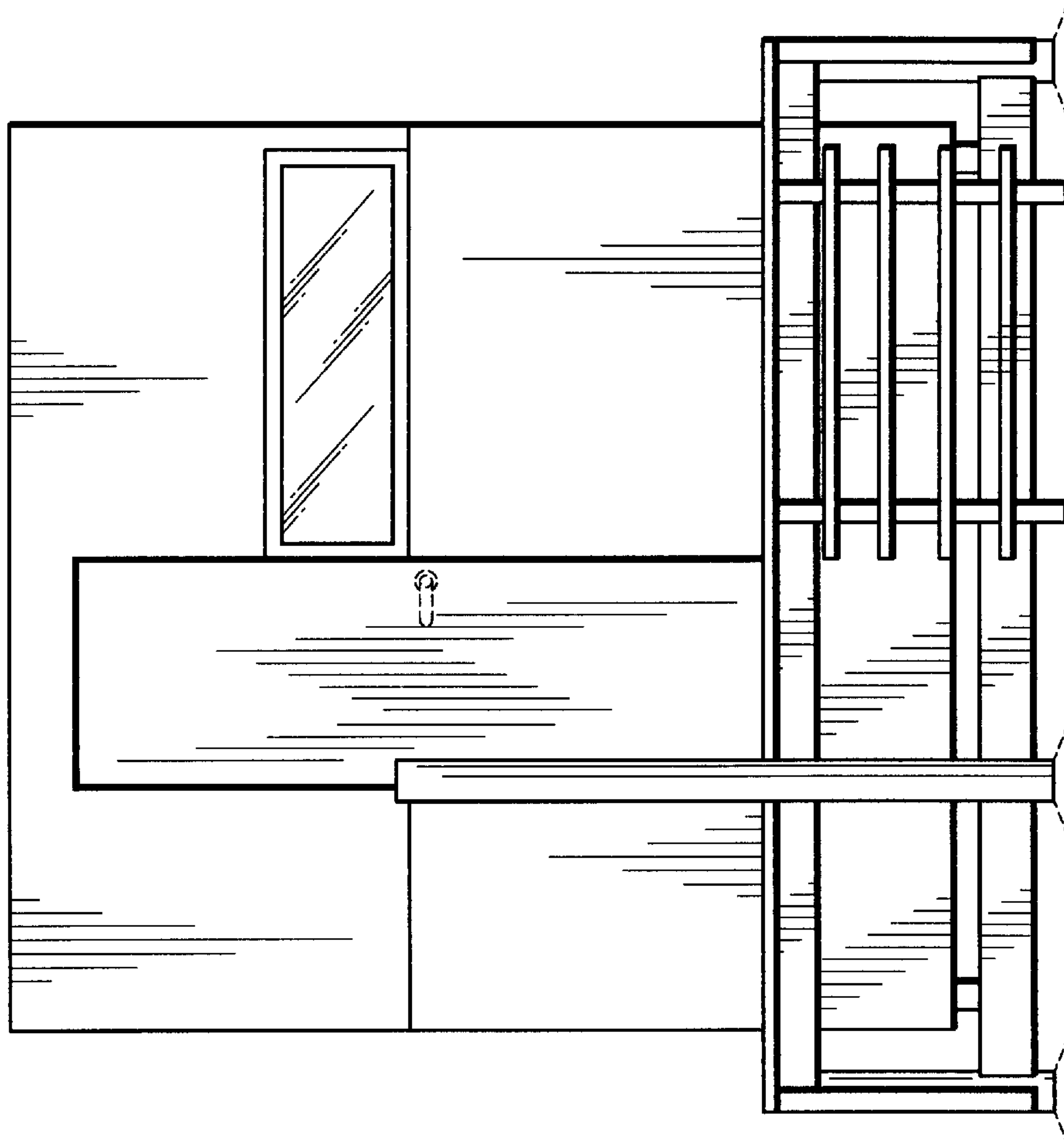

Fig. 1

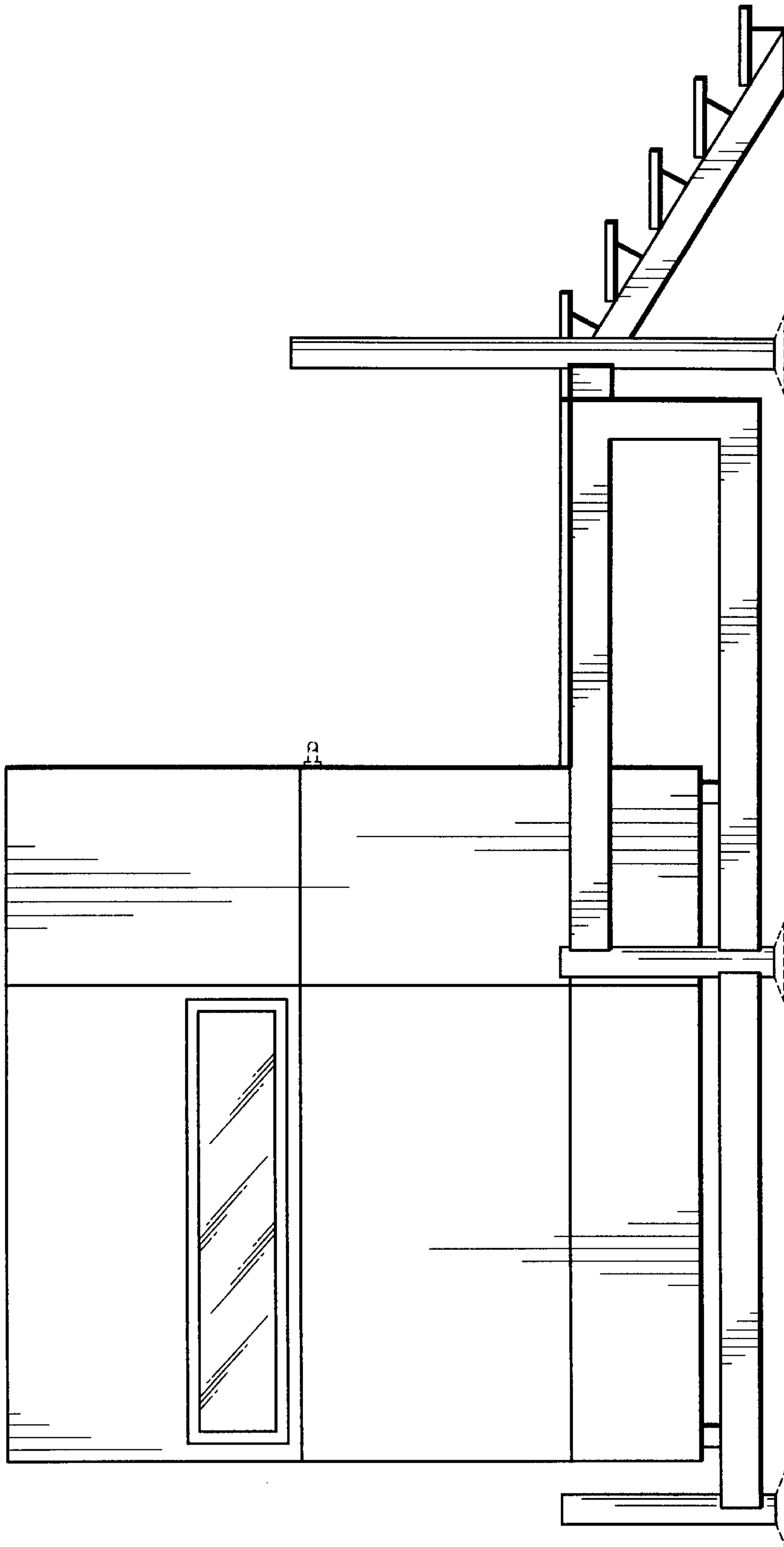

Fig. 2

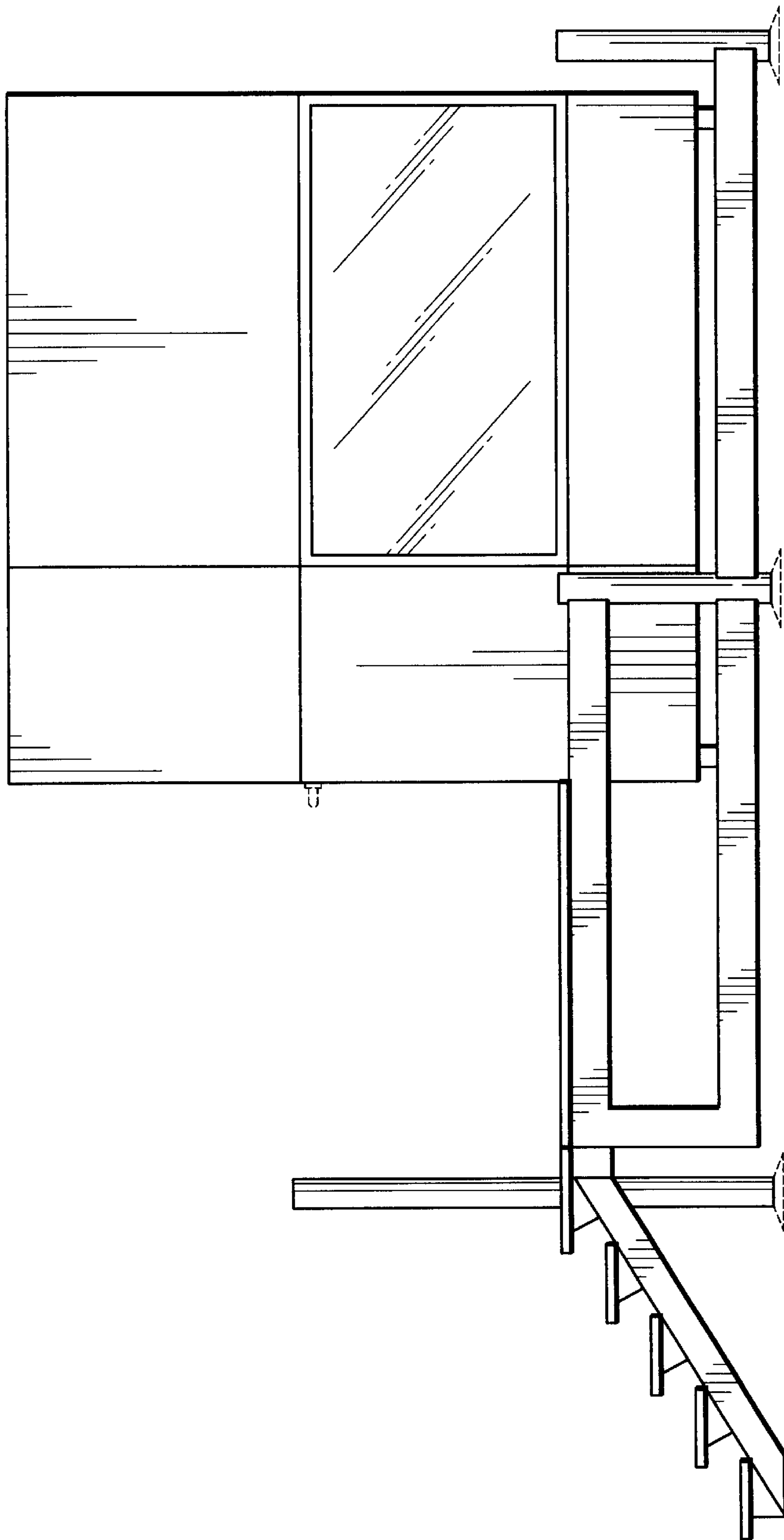

Fig. 3

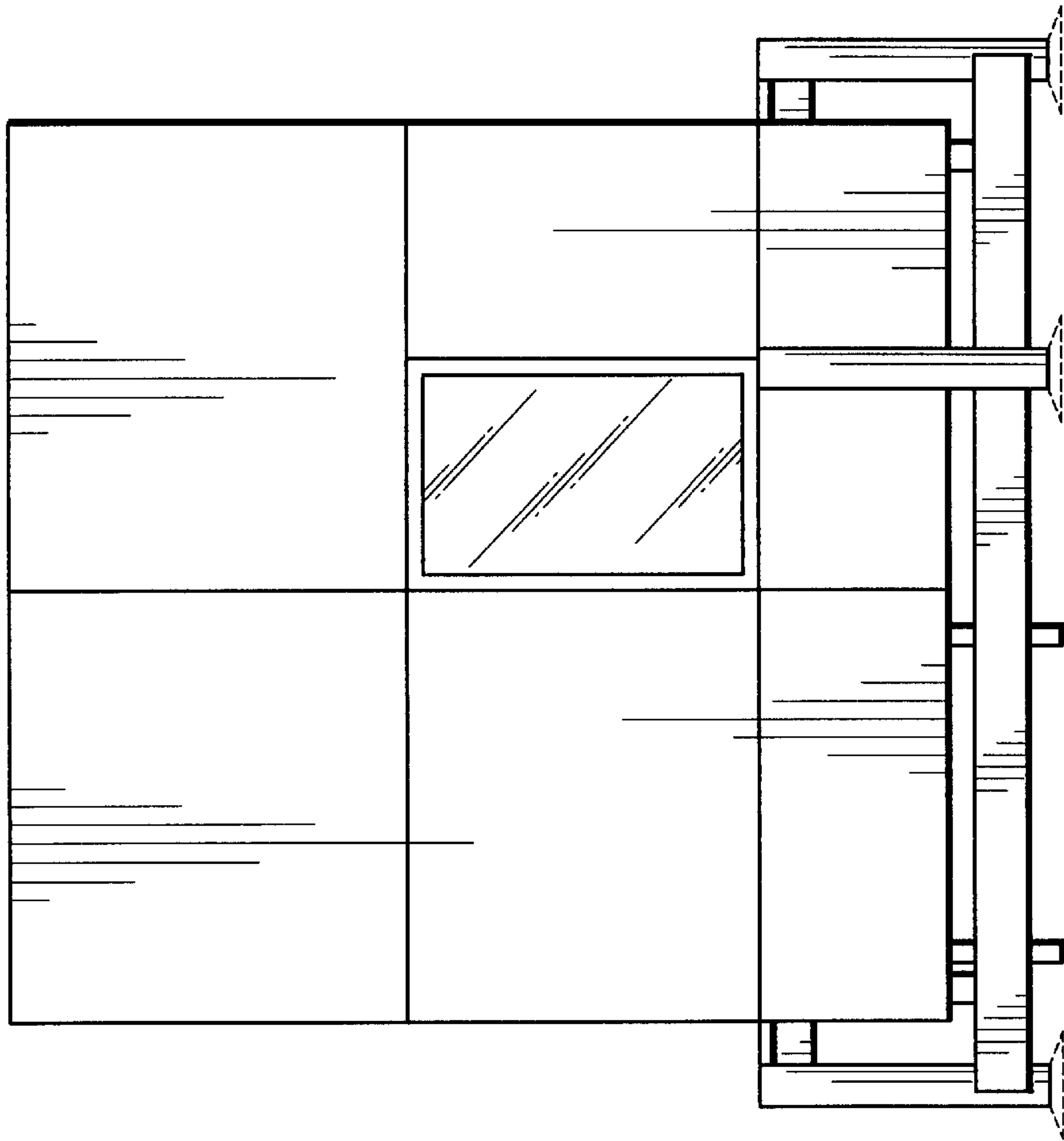

Fig. 4

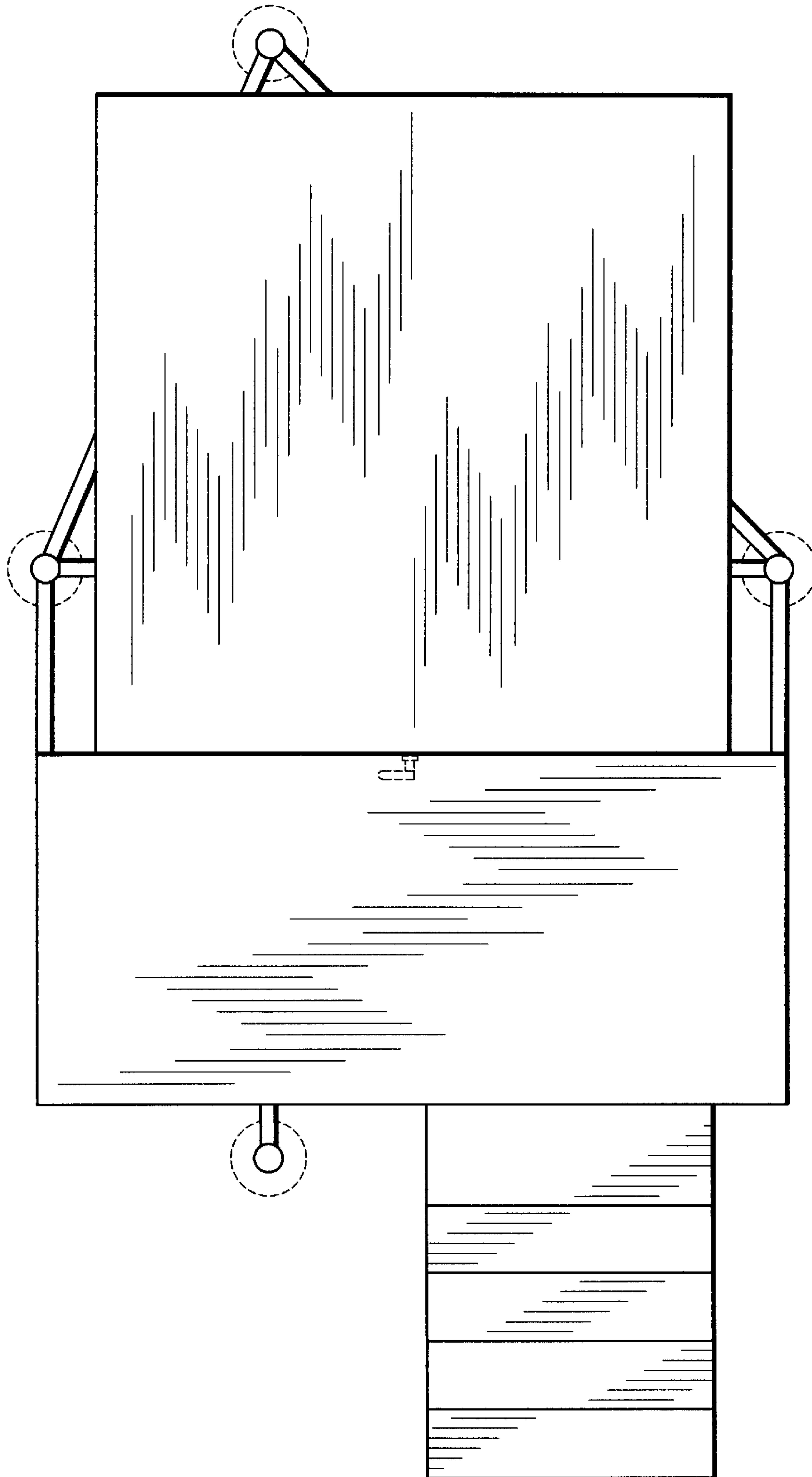

Fig. 5

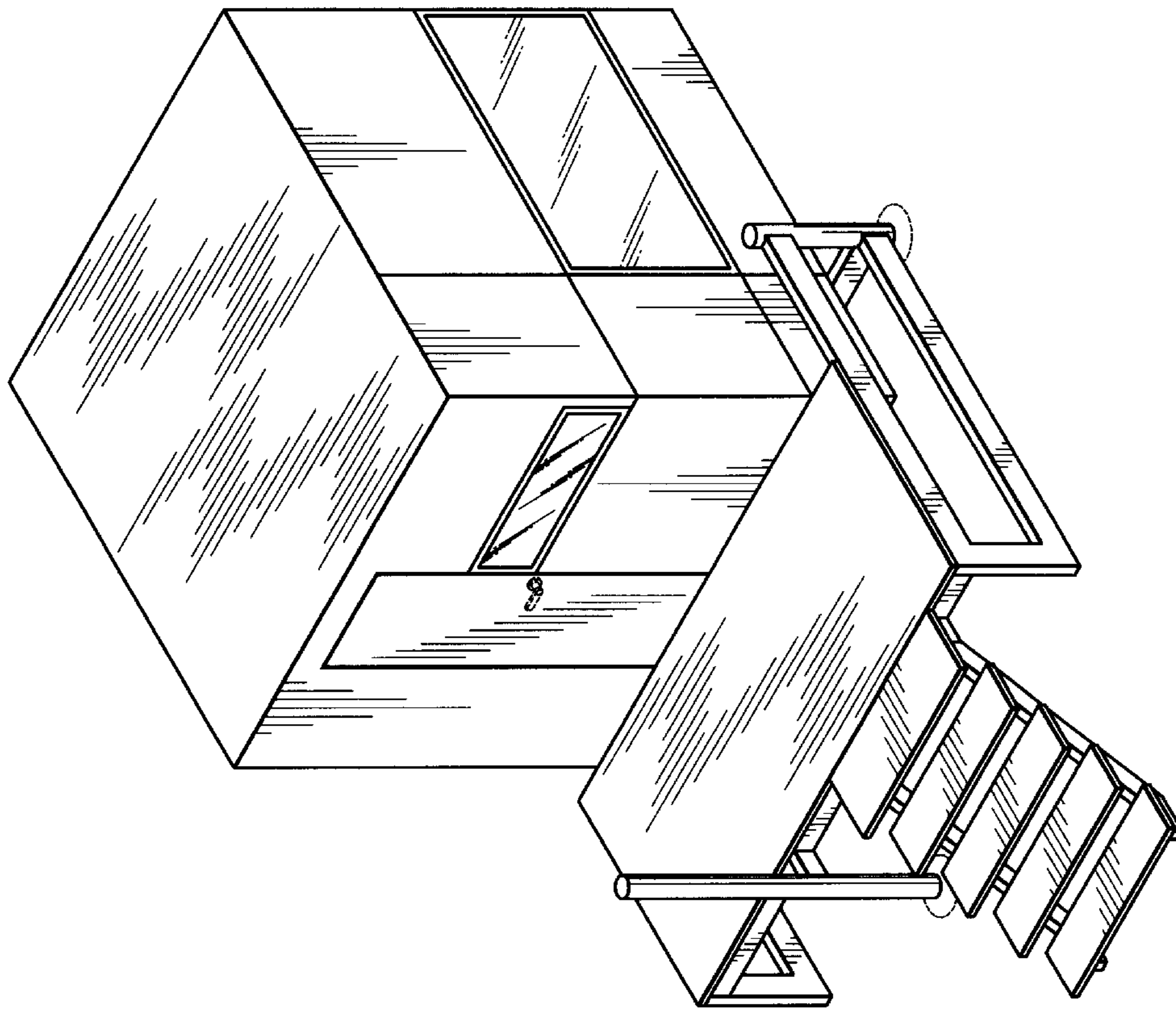

Fig. 6