

US00D541416S

(12) **United States Design Patent**
Baehr et al.

(10) **Patent No.:** **US D541,416 S**
(45) **Date of Patent:** **** Apr. 24, 2007**

(54) **HANDLE FOR A MEDICAL INSTRUMENT**

(75) Inventors: **Heiko Baehr**, Dauchingen (DE);
Helmut Wehrstein, Tuttlingen (DE)
(73) Assignee: **Karl Storz GmbH & Co. KG** (DE)
(**) Term: **14 Years**

(21) Appl. No.: **29/231,227**

(22) Filed: **Jun. 2, 2005**

(30) **Foreign Application Priority Data**

Dec. 7, 2004 (EM) 000264957-0001

(51) **LOC (8) Cl.** **24-02**

(52) **U.S. Cl.** **D24/133; D24/138; D24/146**

(58) **Field of Classification Search** D8/51,
D8/57, 107; D24/133, 137, 138, 143, 145,
D24/146, 147, 148, 149; 128/749, 751; 600/101,
600/104, 105, 108, 109; 606/45, 106, 170,
606/174, 205, 208

See application file for complete search history.

(56) **References Cited**

U.S. PATENT DOCUMENTS

D289,437 S * 4/1987 Honkanen D24/148
4,977,900 A * 12/1990 Fehling et al. 600/564
D338,065 S * 8/1993 Rose D24/143
D350,606 S * 9/1994 Koros et al. D24/143
5,356,408 A * 10/1994 Rydell 606/48
D362,908 S * 10/1995 Shutt et al. D24/143
D366,525 S * 1/1996 Toy et al. D24/143
D370,064 S * 5/1996 Livneh D24/146
6,371,956 B1 * 4/2002 Wilson et al. 606/49
D465,281 S * 11/2002 Lang D24/147
D505,725 S * 5/2005 Karl-Heinz D24/146

OTHER PUBLICATIONS

Insulated and Metal Handles, Karl Storz Endoscope, pp. 77-79.
Plugs and Handle Accessories, Karl Storz Endoscope, p. 80.
Dissecting and Grasping Forceps, Karl Storz Endoscope, p. 95.

* cited by examiner

Primary Examiner—Alan P. Douglas

Assistant Examiner—Deanna Fluegeman

(74) *Attorney, Agent, or Firm*—St. Onge Steward Johnston & Reens LLC

(57) **CLAIM**

The ornamental design for “handle for medical instrument,” as shown and described.

DESCRIPTION

FIG. 1 is a left side view of a handle for a medical instrument in accordance with the new design;

FIG. 2 is a right side view of the handle for a medical instrument of FIG. 1;

FIG. 3 is a front view of the handle for a medical instrument of FIG. 1;

FIG. 4 is a rear view of the handle for a medical instrument of FIG. 1;

FIG. 5 is a top view of the handle for a medical instrument of FIG. 1;

FIG. 6 is a rear view of the handle for a medical instrument of FIG. 1; and,

FIG. 7 is a perspective view of the handle for a medical instrument of FIG. 1.

The broken lines shown are for illustrative purposes only and form no part of the claimed design.

1 Claim, 5 Drawing Sheets

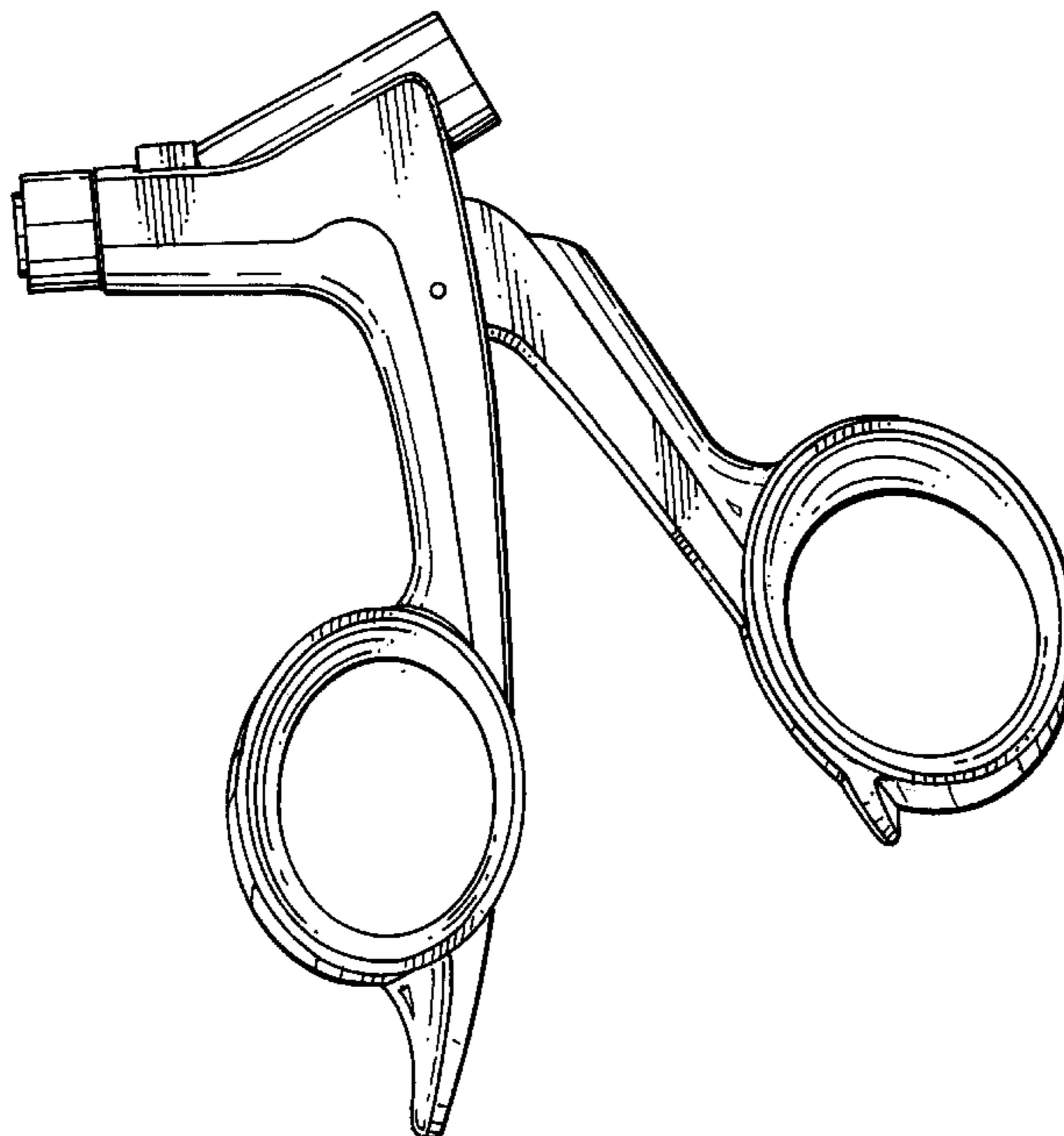

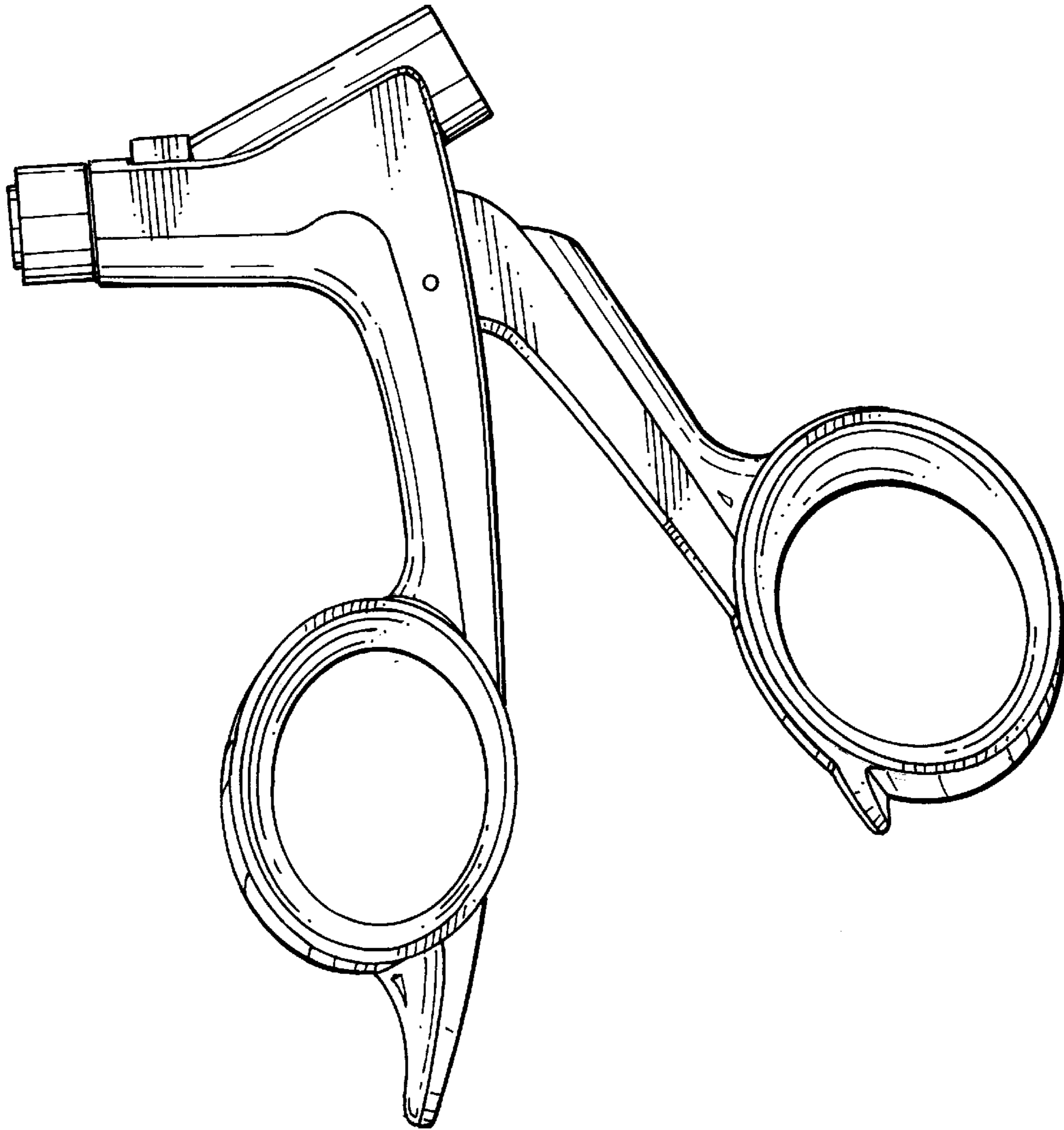

FIG. 1

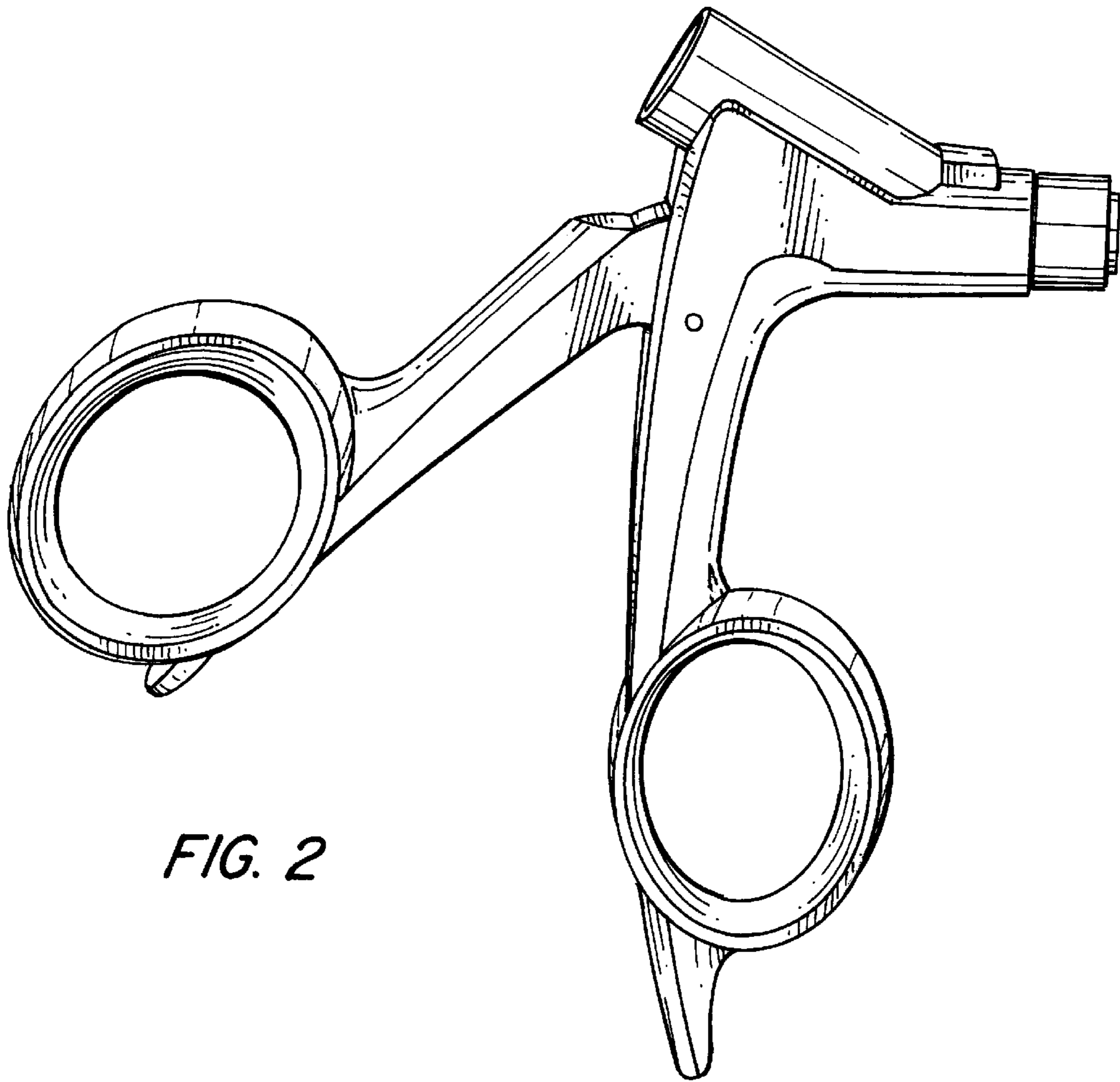

FIG. 2

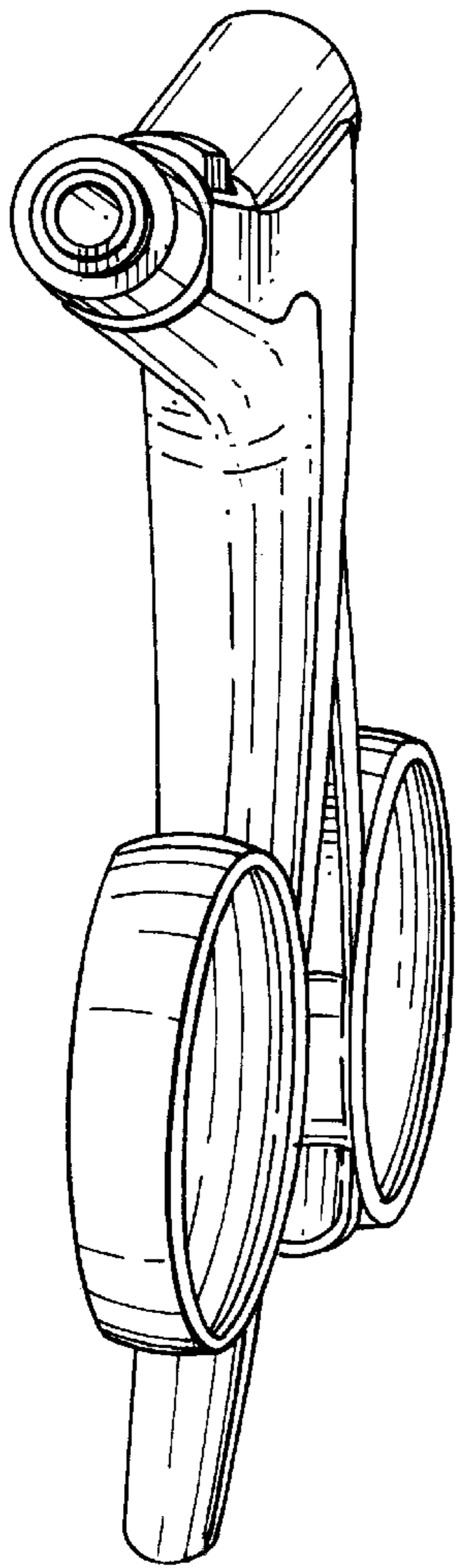

FIG. 3

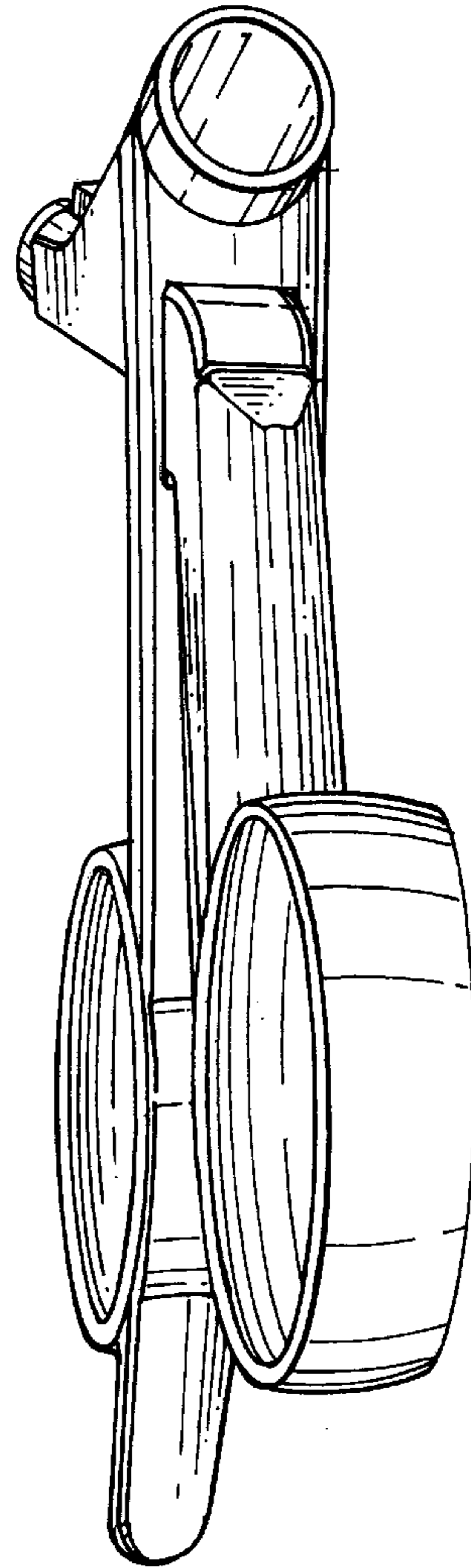

FIG. 4

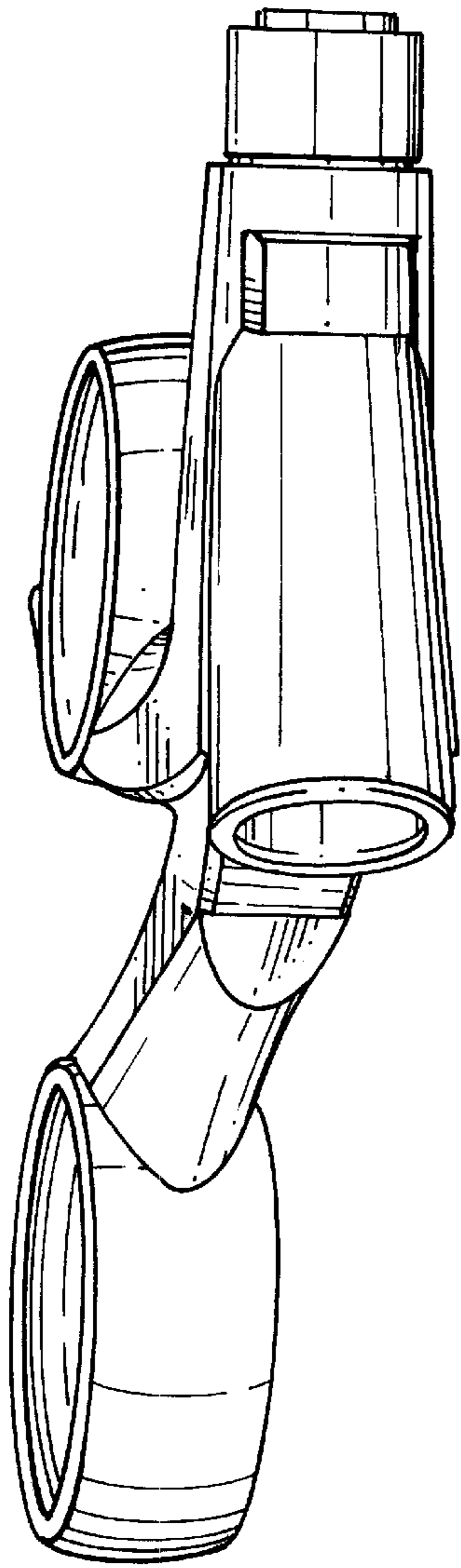

FIG. 5

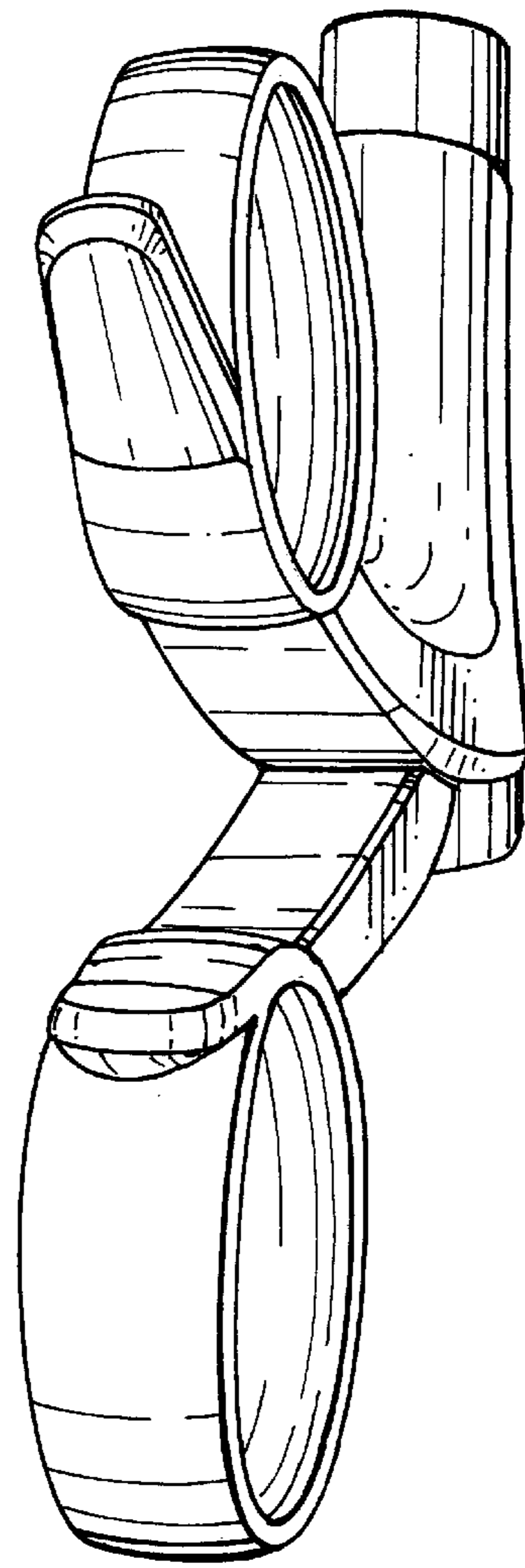

FIG. 6

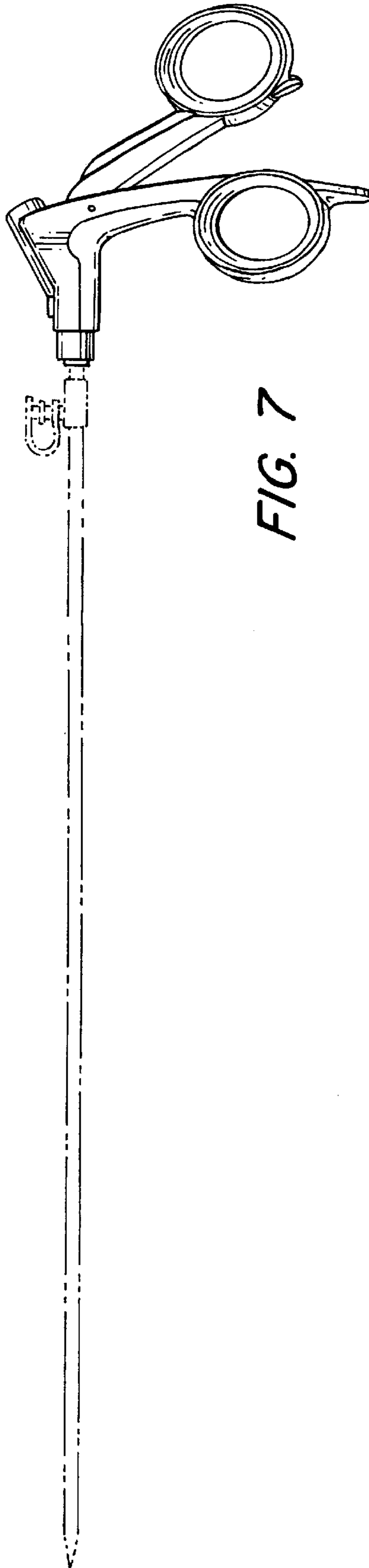

FIG. 7