



US00D541397S

(12) **United States Design Patent**
Chien

(10) **Patent No.:** **US D541,397 S**

(45) **Date of Patent:** **** Apr. 24, 2007**

(54) **ELECTRIC HEATER**

(76) Inventor: **Hung-Chi Chien**, Rm. 4C 26, No. 5,
Hainyi Rd., Sec. 5, Taipei (TW)

(**) Term: **14 Years**

(21) Appl. No.: **29/235,499**

(22) Filed: **Aug. 3, 2005**

(30) **Foreign Application Priority Data**

Feb. 3, 2005 (TW) 094300673
Feb. 4, 2005 (TW) 094202202

(51) **LOC (8) Cl.** **23-03**

(52) **U.S. Cl.** **D23/335**

(58) **Field of Classification Search** D23/314,
D23/332, 335-337, 339-341; 126/9 A, 92 A,
126/92 B, 92 AC, 110 B, 110 D; 392/365-369,
392/373-376; 312/236
See application file for complete search history.

(56) **References Cited**

U.S. PATENT DOCUMENTS

D455,824 S * 4/2002 Walker D23/335

D504,941 S * 5/2005 Blateri D23/335
D509,889 S * 9/2005 Blateri D23/335
D515,677 S * 2/2006 Blateri D23/335
D516,688 S * 3/2006 Blateri D23/335
D526,058 S * 8/2006 Blateri D23/332

* cited by examiner

Primary Examiner—Brian N Vinson

(74) *Attorney, Agent, or Firm*—Troxell Law Office PLLC

(57) **CLAIM**

The ornamental design for an electric heater, as shown and described.

DESCRIPTION

FIG. 1 is a perspective view of an electric heater showing my new design;
FIG. 2 is front elevational view thereof;
FIG. 3 is a right side elevational view thereof;
FIG. 4 is a top plan view thereof;
FIG. 5 is a bottom plan view thereof;
FIG. 6 is a rear elevational view thereof; and,
FIG. 7 is a left side elevational view thereof.

1 Claim, 4 Drawing Sheets

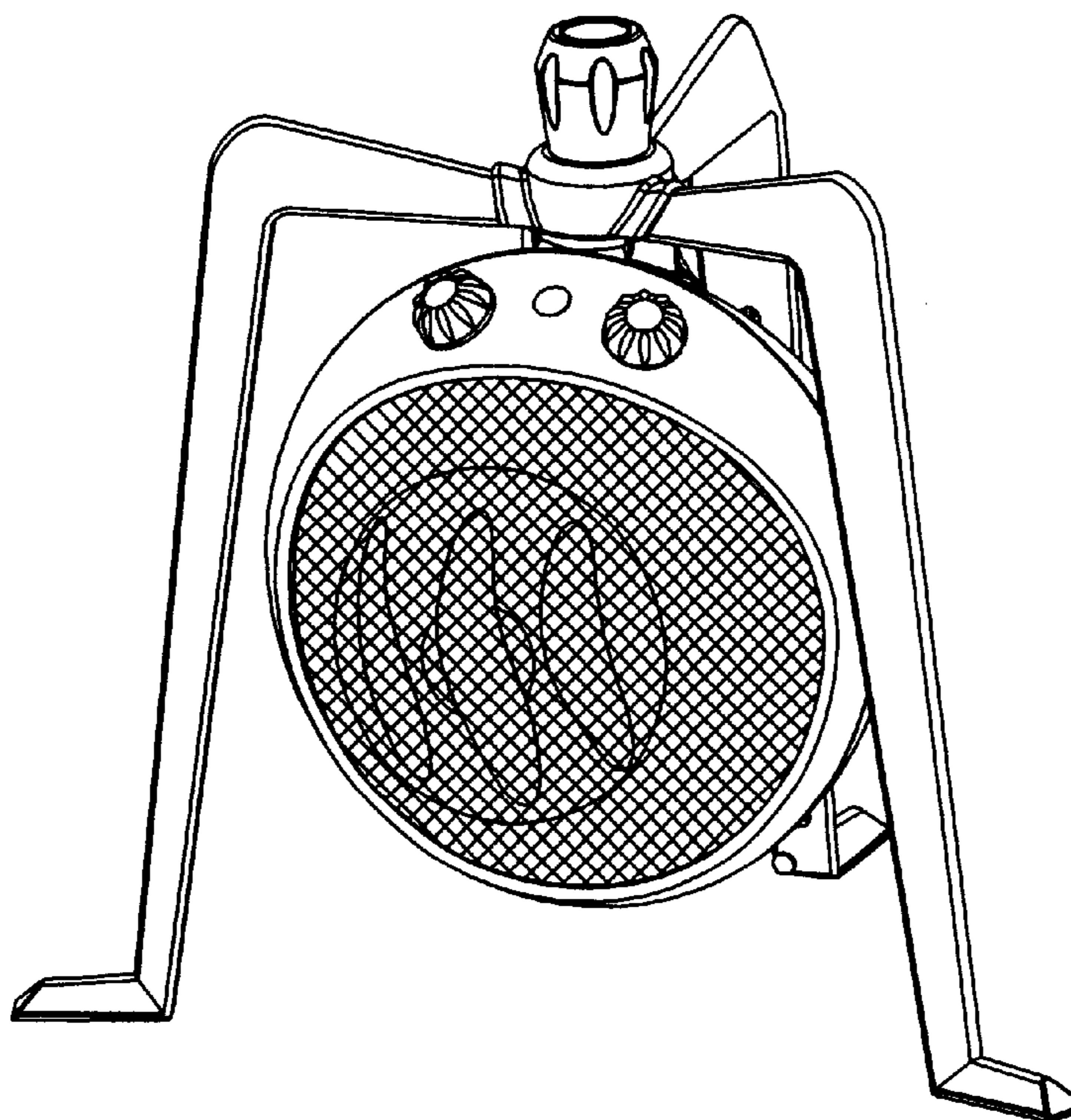

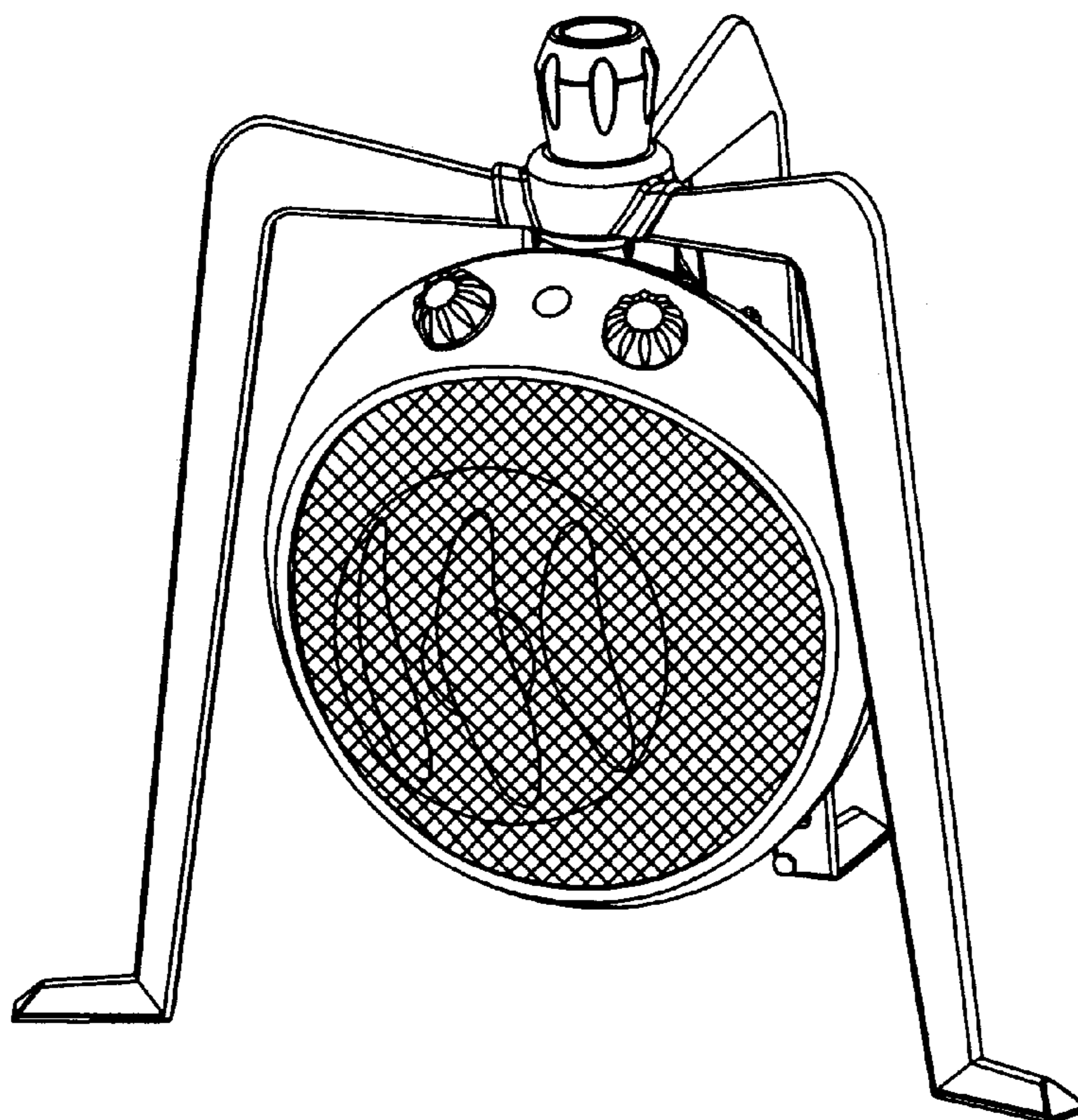

FIG. 1

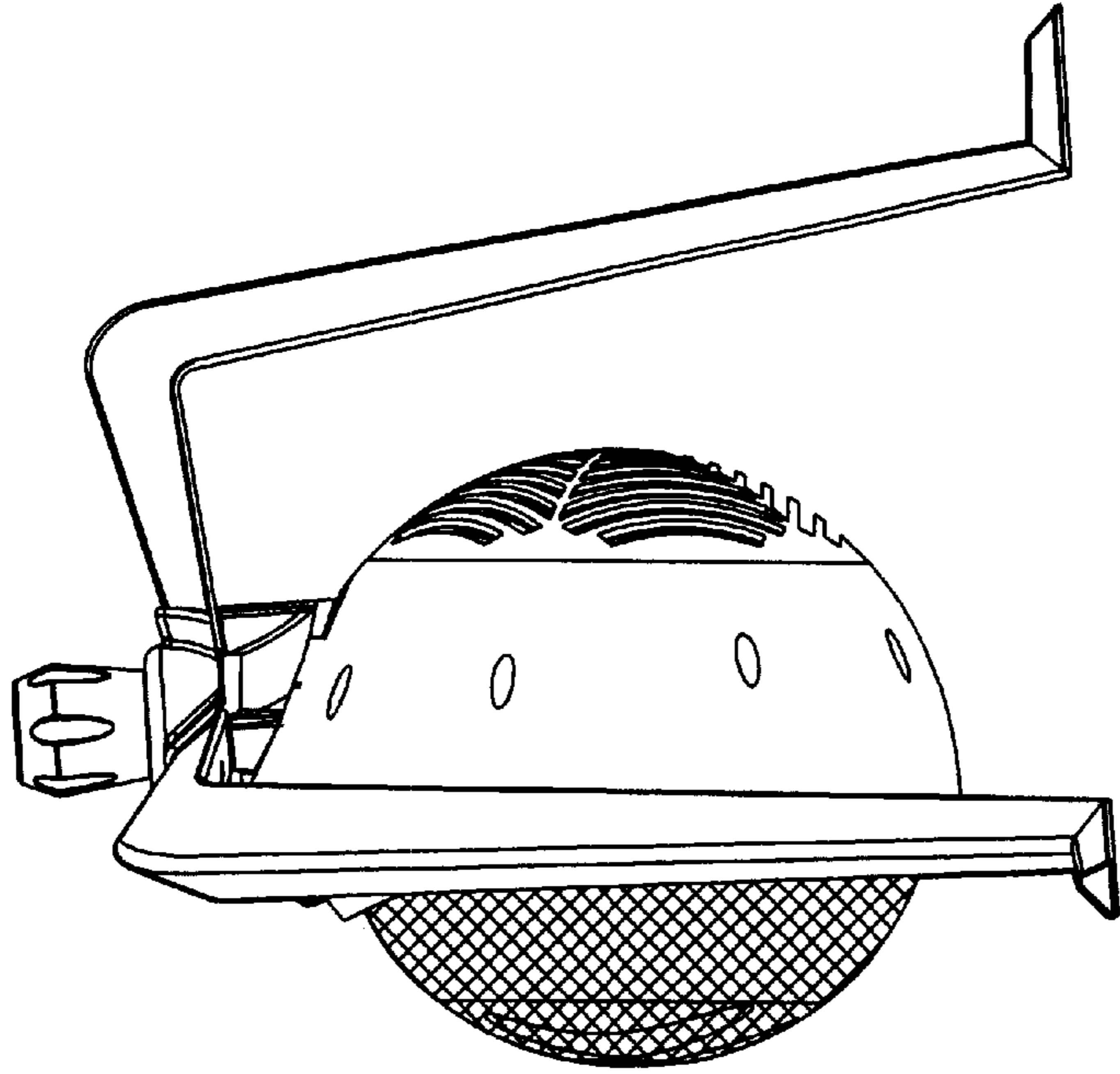

FIG. 3

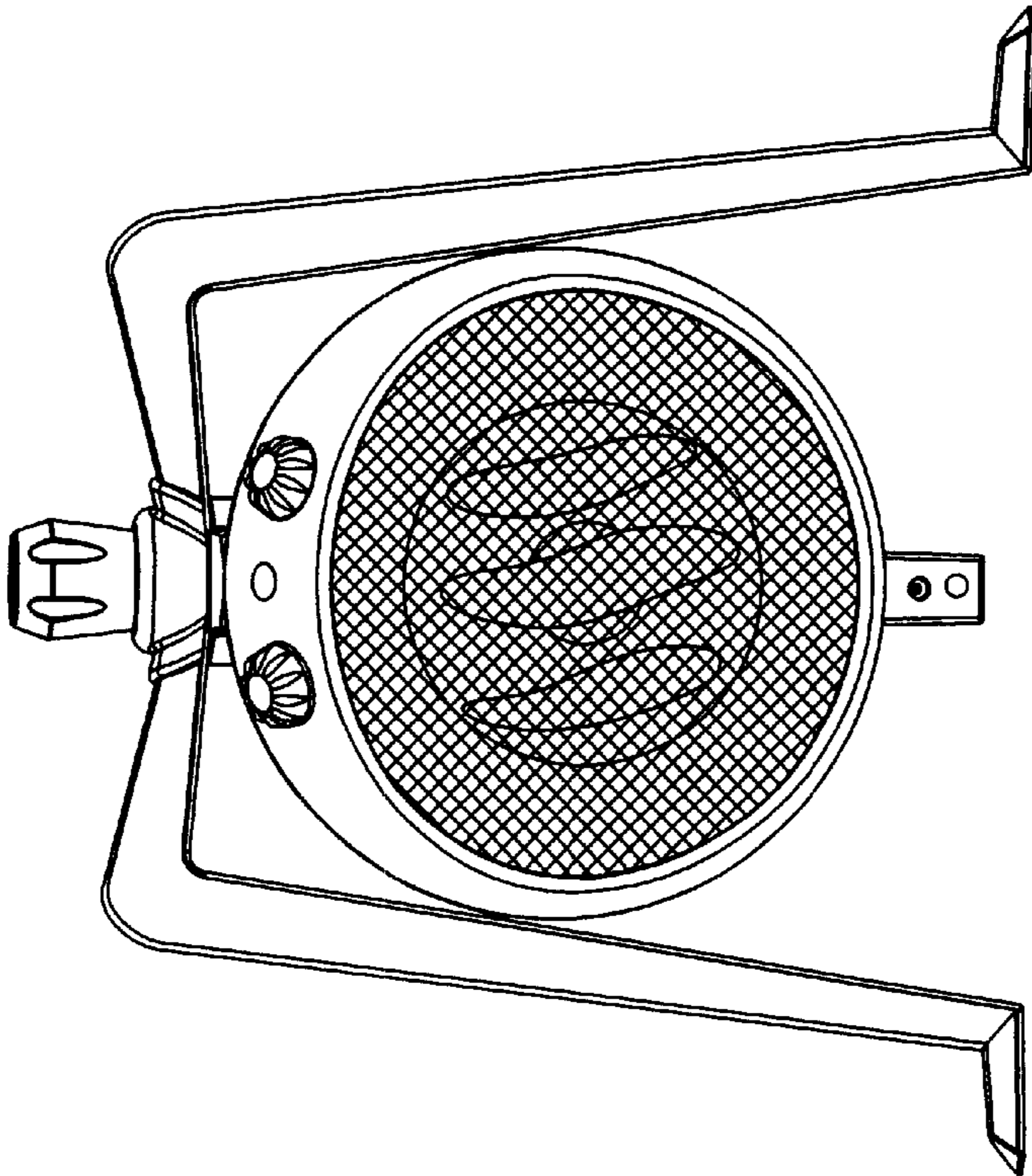

FIG. 2

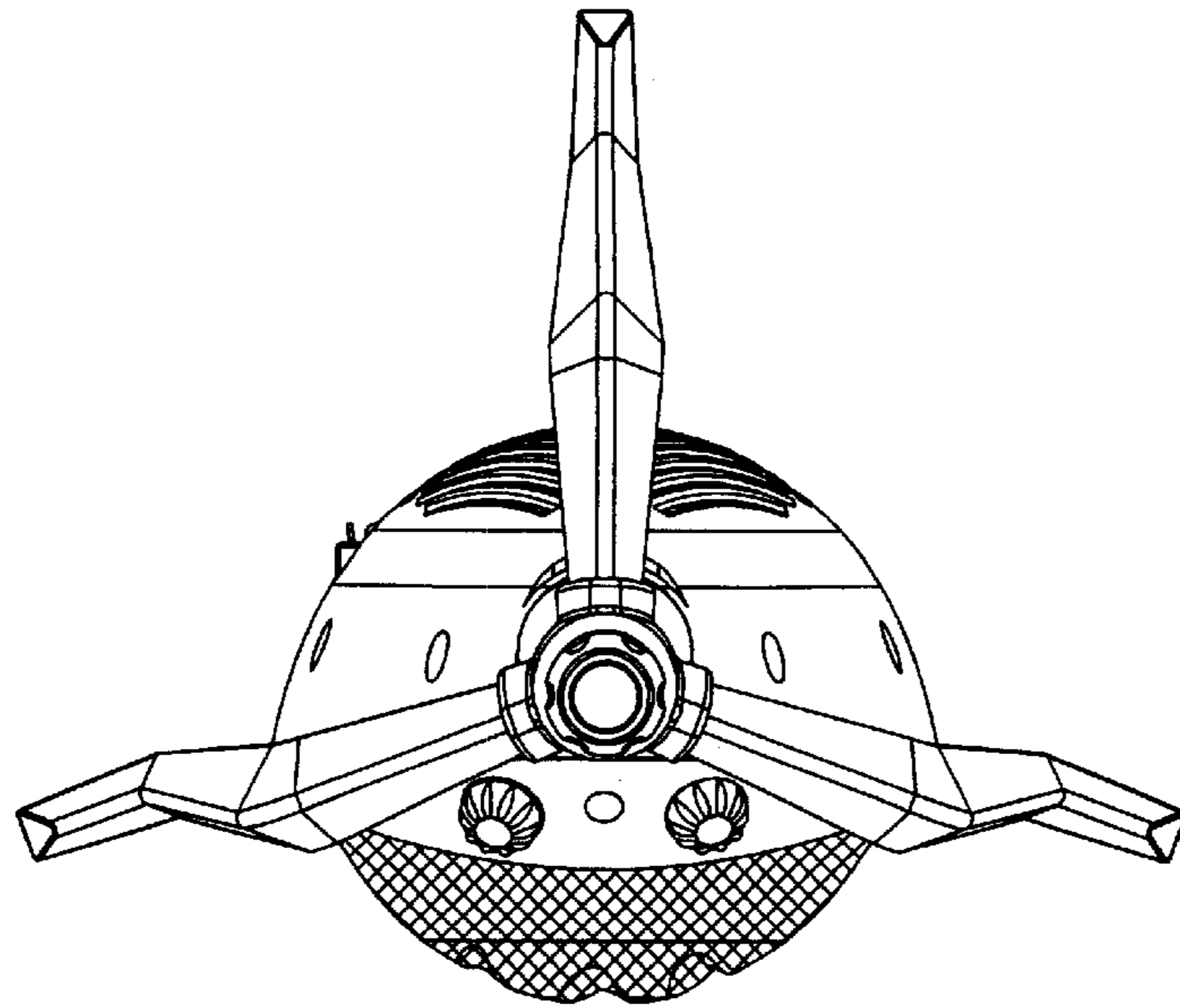

FIG. 4

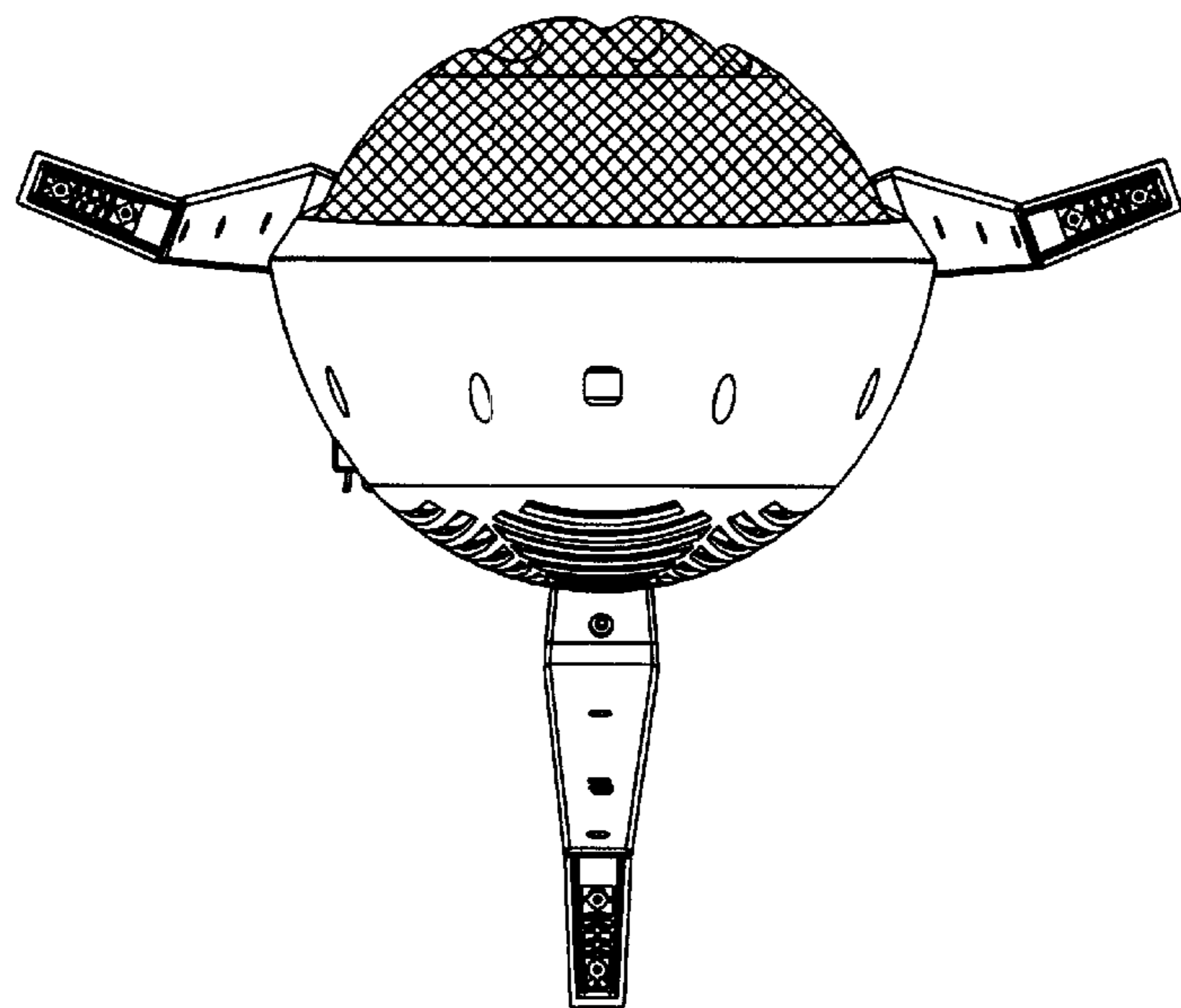

FIG. 5

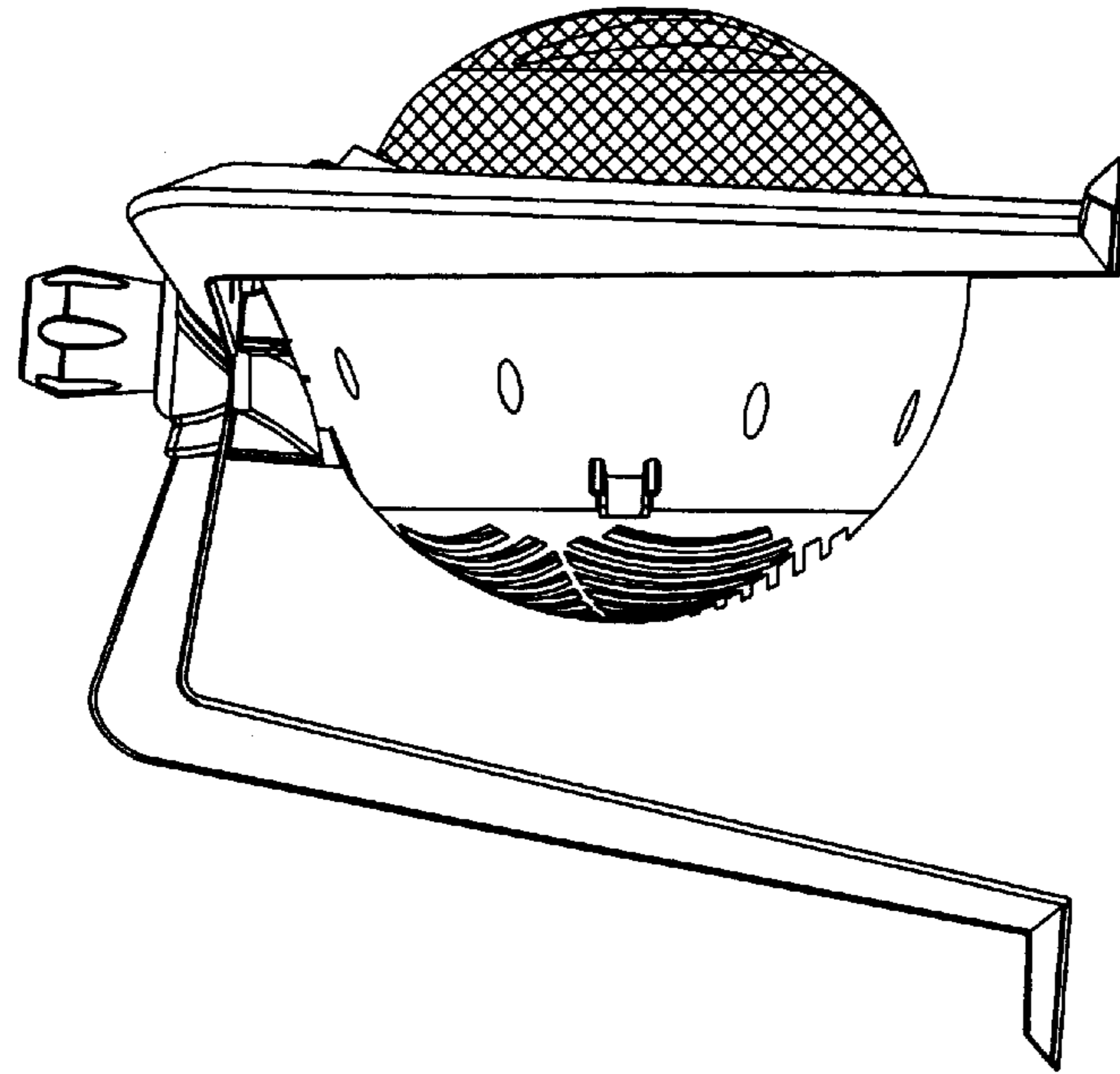

FIG. 7

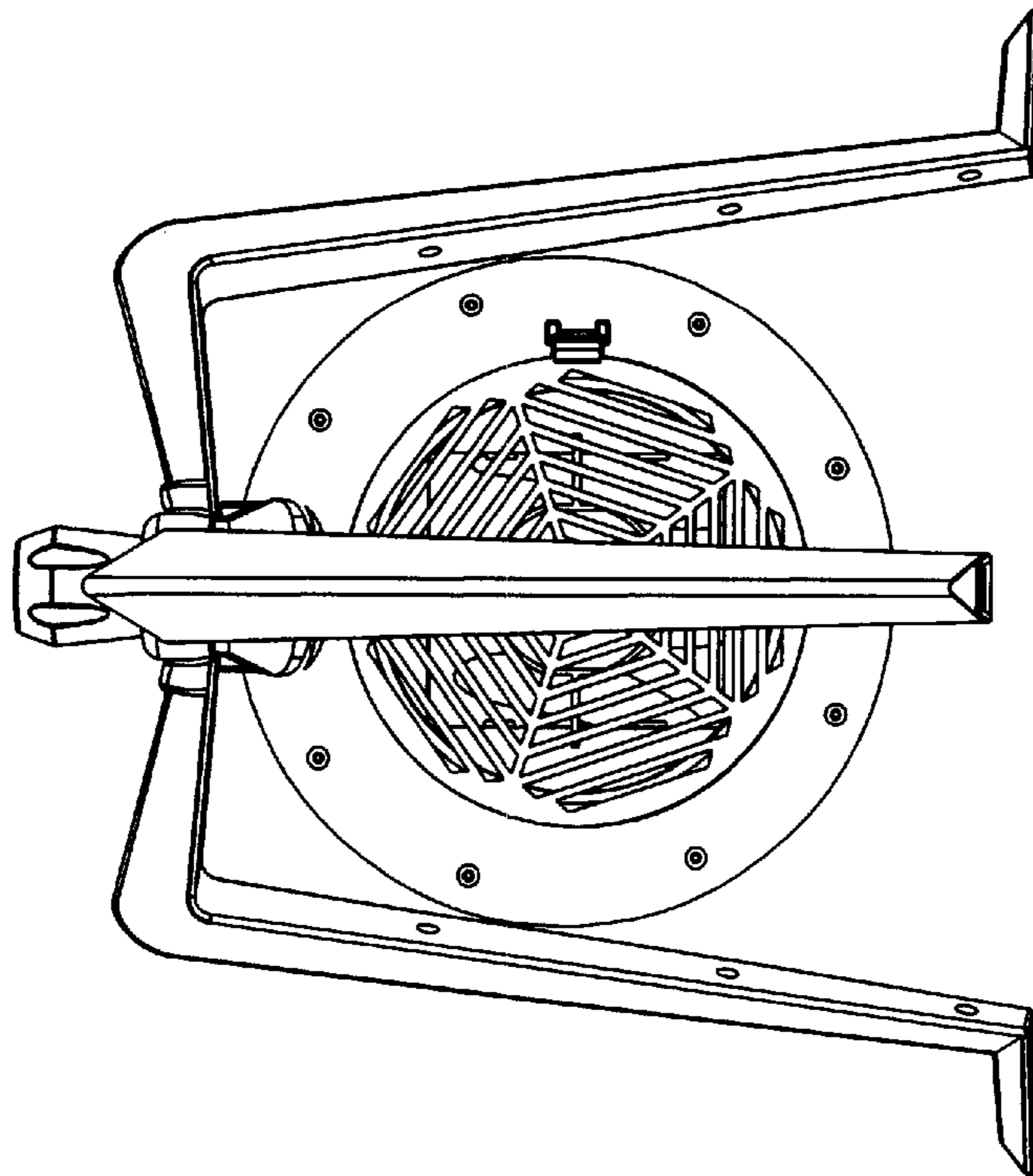

FIG. 6