

US00D541360S

(12) **United States Design Patent**
Schweigert et al.

(10) **Patent No.: US D541,360 S**

(45) **Date of Patent: ** *Apr. 24, 2007**

(54) **GOLF IRON HEAD**

(75) Inventors: **Bradley D. Schweigert**, Anthem, AZ (US); **Michael R. Nicolette**, Scottsdale, AZ (US); **Marty R. Jertson**, Phoenix, AZ (US); **John A. Solheim**, Phoenix, AZ (US); **Eric V. Cole**, Phoenix, AZ (US)

(73) Assignee: **Karsten Manufacturing Corporation**, Phoenix, AZ (US)

(*) Notice: This patent is subject to a terminal disclaimer.

(**) Term: **14 Years**

(21) Appl. No.: **29/261,460**

(22) Filed: **Jun. 13, 2006**

Related U.S. Application Data

(62) Division of application No. 29/230,838, filed on May 25, 2003.

(51) **LOC (8) Cl.** **21-02**

(52) **U.S. Cl.** **D21/747**

(58) **Field of Classification Search** D21/747-751;
473/324-331, 350

See application file for complete search history.

(56) **References Cited**

U.S. PATENT DOCUMENTS

D228,355 S * 9/1973 Penna D21/749
D256,264 S 8/1980 Solheim
D379,393 S 5/1997 Kubica
D422,043 S 3/2000 Kubica

D429,299 S 8/2000 Kubica
D442,659 S * 5/2001 Kubica et al. D21/747
D443,008 S 5/2001 Kubica
D468,787 S * 1/2003 Oosthuizen D21/747
D469,136 S * 1/2003 Roberts D21/747
D470,554 S 2/2003 Truesdale
D494,648 S 8/2004 Schweigert
D500,350 S 12/2004 Schweigert
D500,351 S * 12/2004 Schweigert et al. D21/747
D502,237 S 2/2005 Schweigert
D502,975 S 3/2005 Schweigert
D504,925 S * 5/2005 Schweigert et al. D21/748
D505,171 S * 5/2005 Schweigert et al. D21/749
D508,099 S 8/2005 Schweigert
D514,183 S * 1/2006 Schweigert et al. D21/748

* cited by examiner

Primary Examiner—Mitchell Siegel

(74) *Attorney, Agent, or Firm*—Darrell F. Marquette

(57) **CLAIM**

The ornamental design for a golf iron head, as shown and described.

DESCRIPTION

FIG. 1 is a perspective view of a golf iron head with a high loft angle such as a wedge showing our new design; FIG. 2 is a toe end view of the golf iron head of FIG. 1; FIG. 3 is a heel end view of the golf iron head of FIG. 1; FIG. 4 is a top view of the golf iron head of FIG. 1; FIG. 5 is a bottom view of the golf iron head of FIG. 1; FIG. 6 is a front elevational view of the golf iron head of FIG. 1; and, FIG. 7 is a rear elevational view of the golf iron head of FIG. 1.

1 Claim, 2 Drawing Sheets

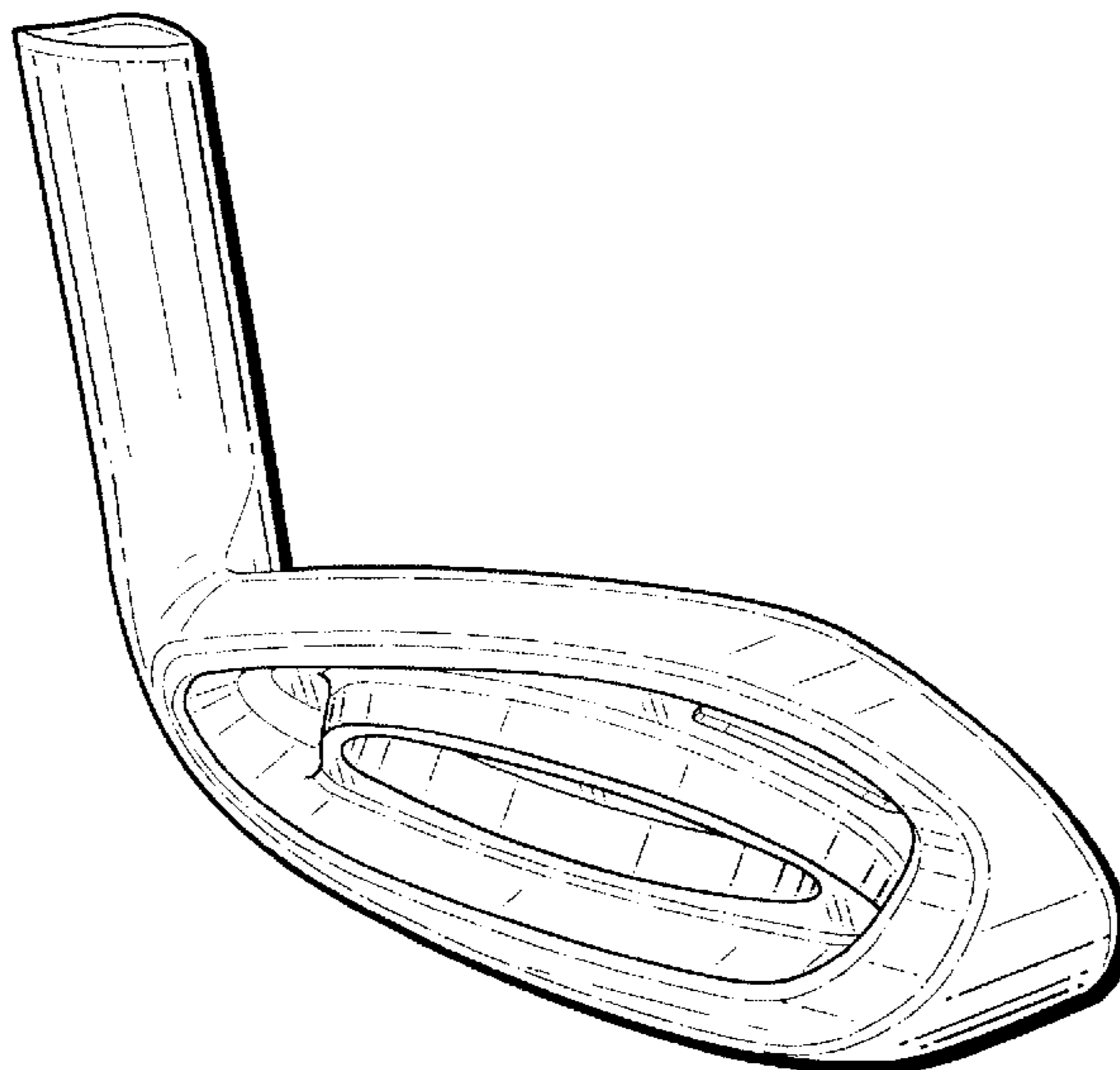

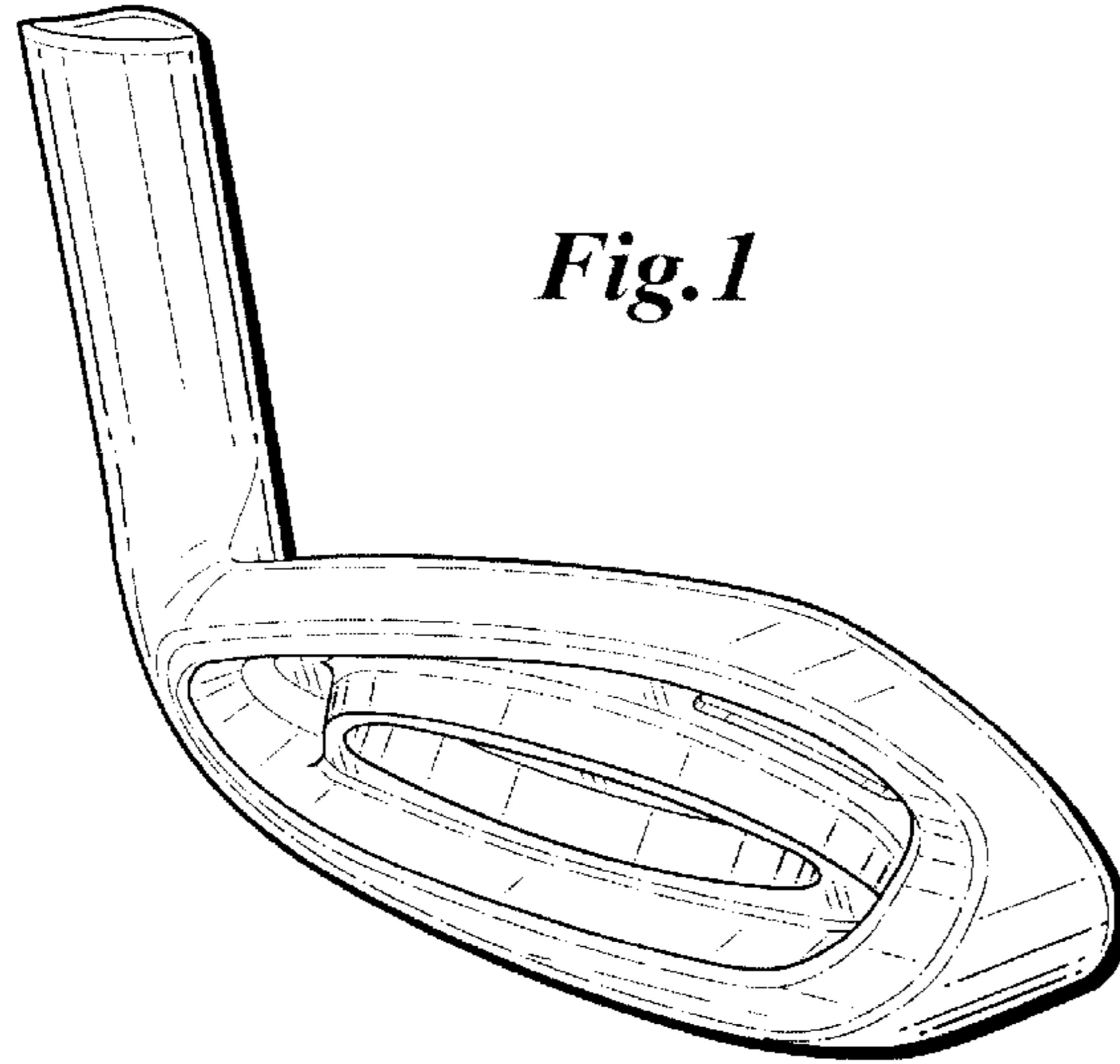

Fig.1

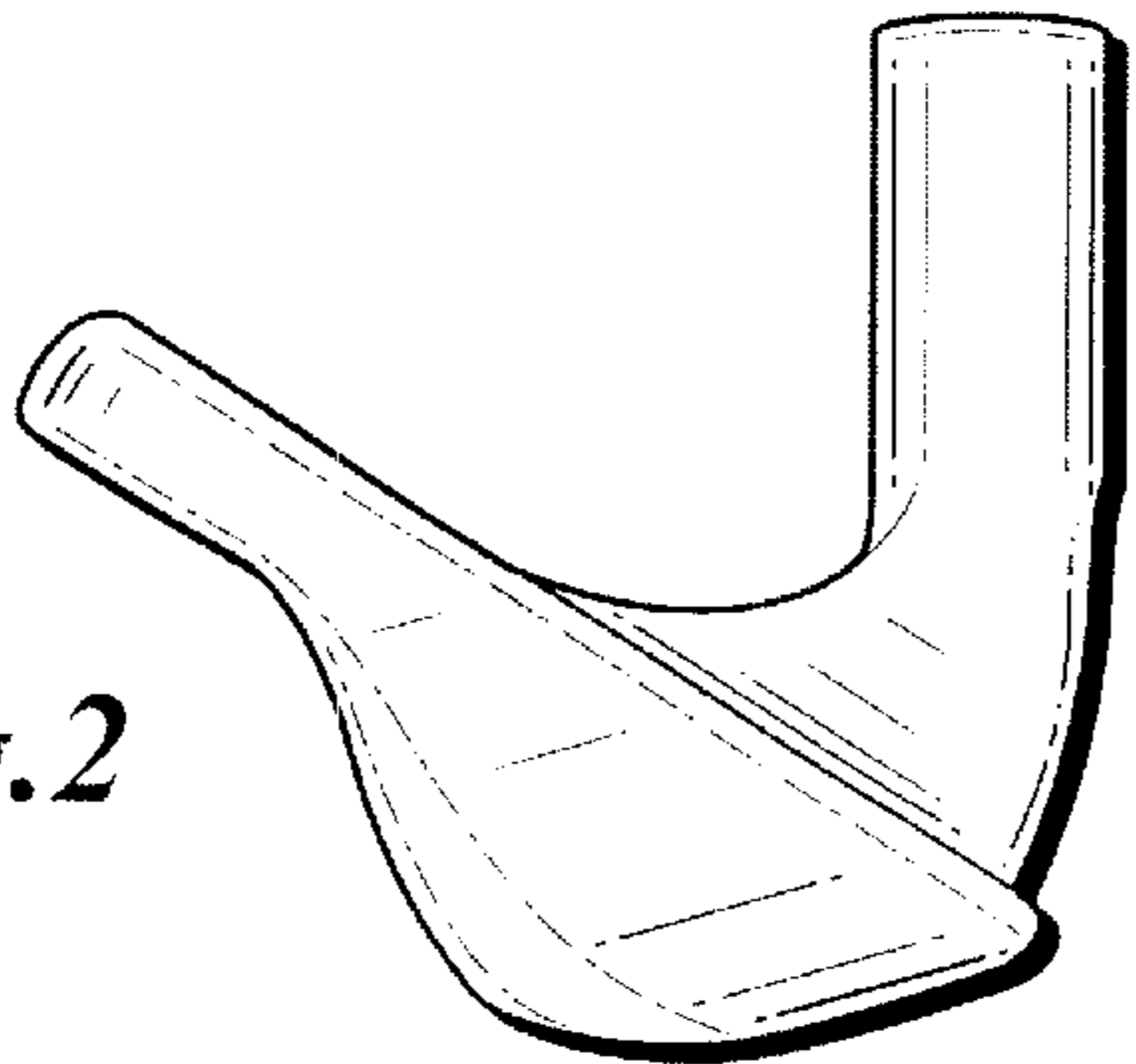

Fig.2

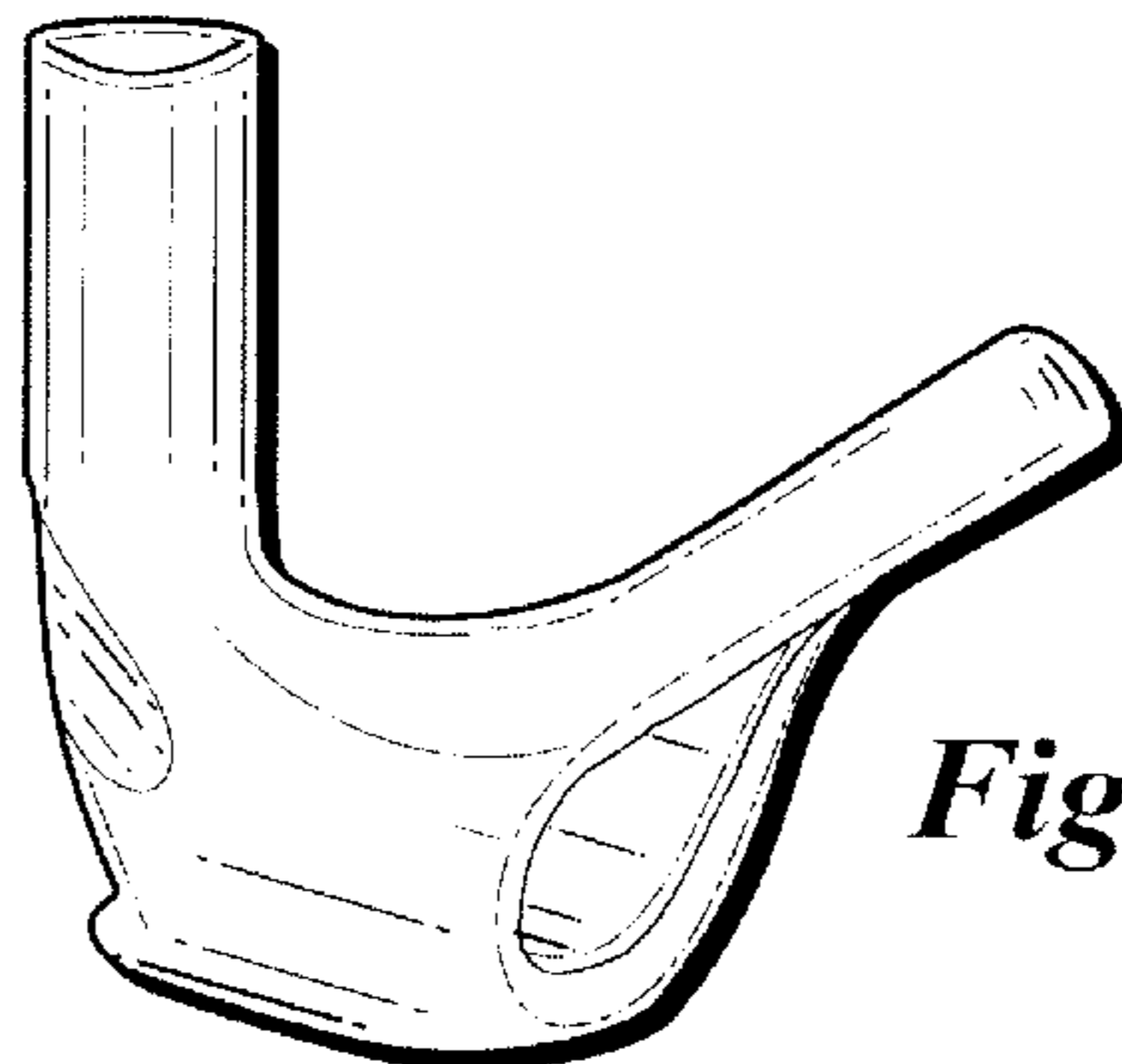

Fig.3

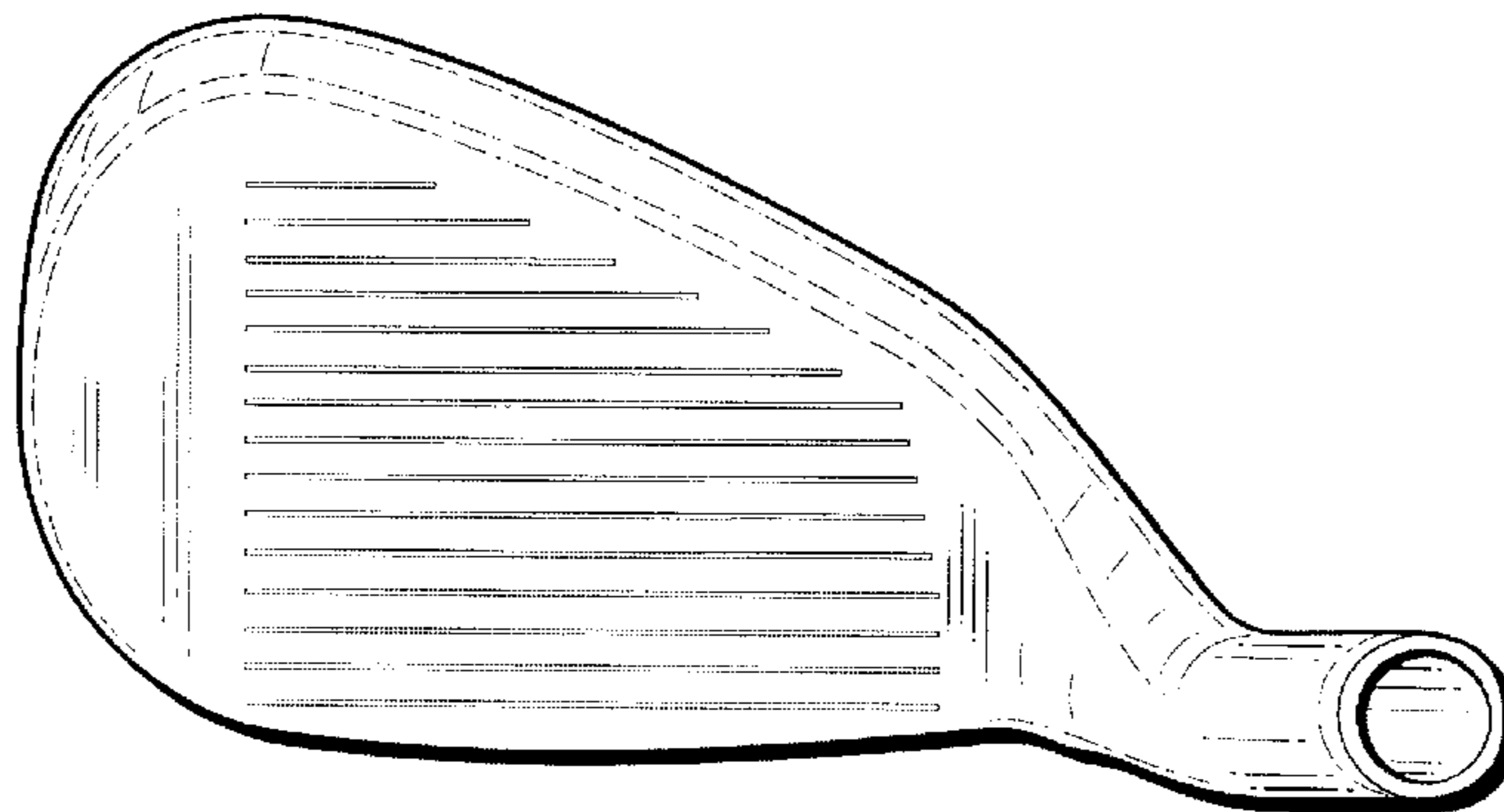

Fig.4

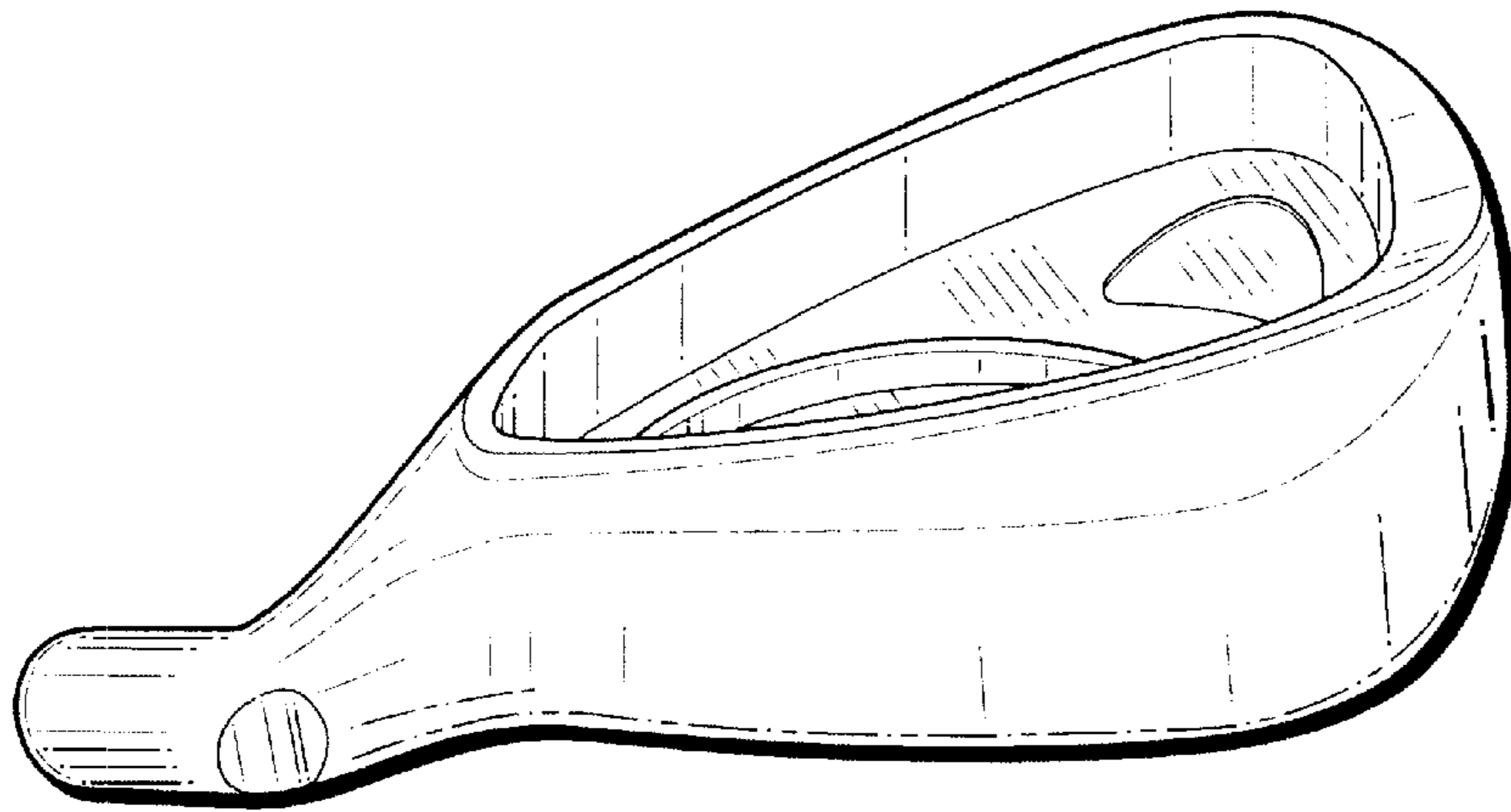

Fig. 5

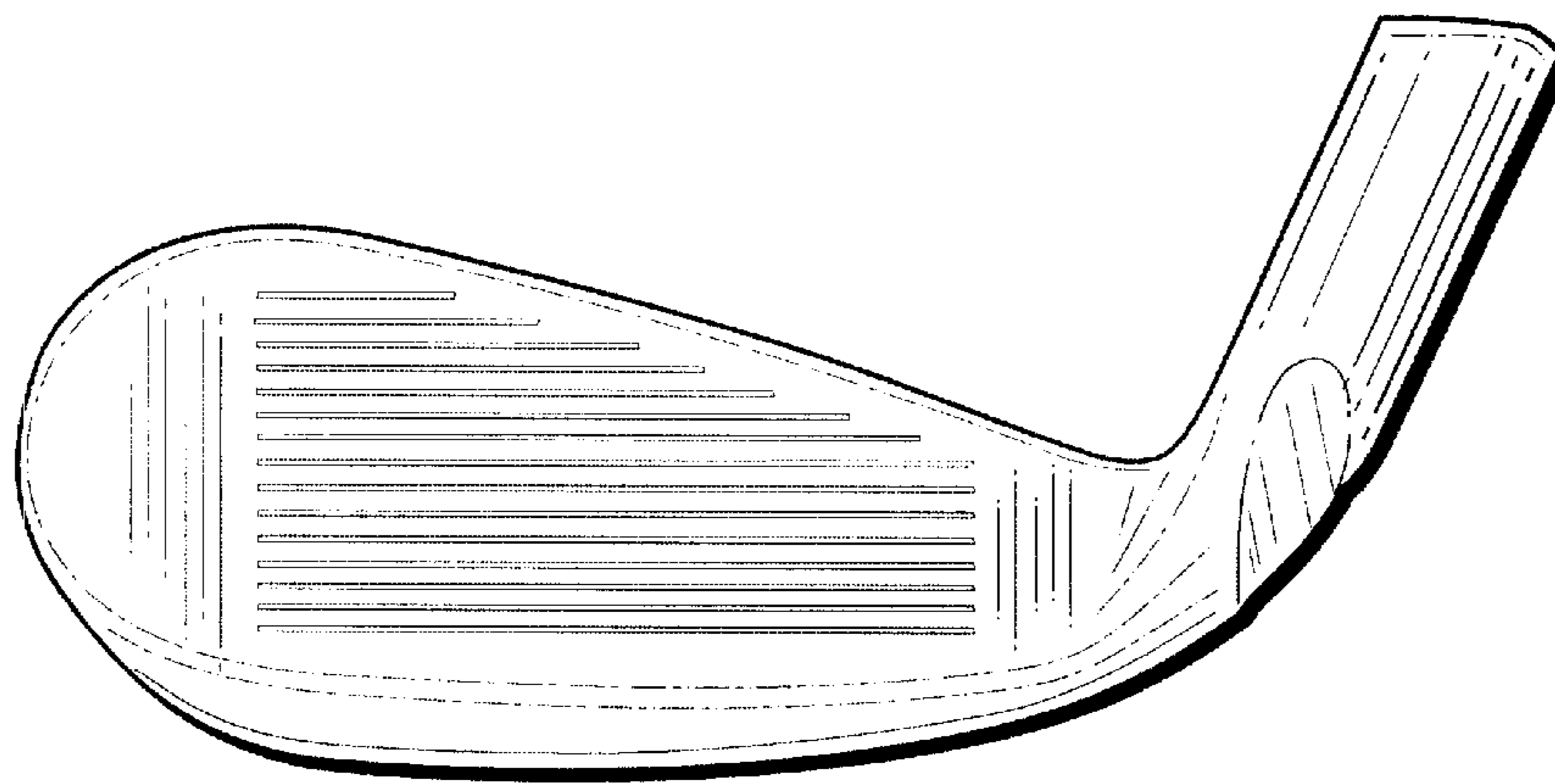

Fig. 6

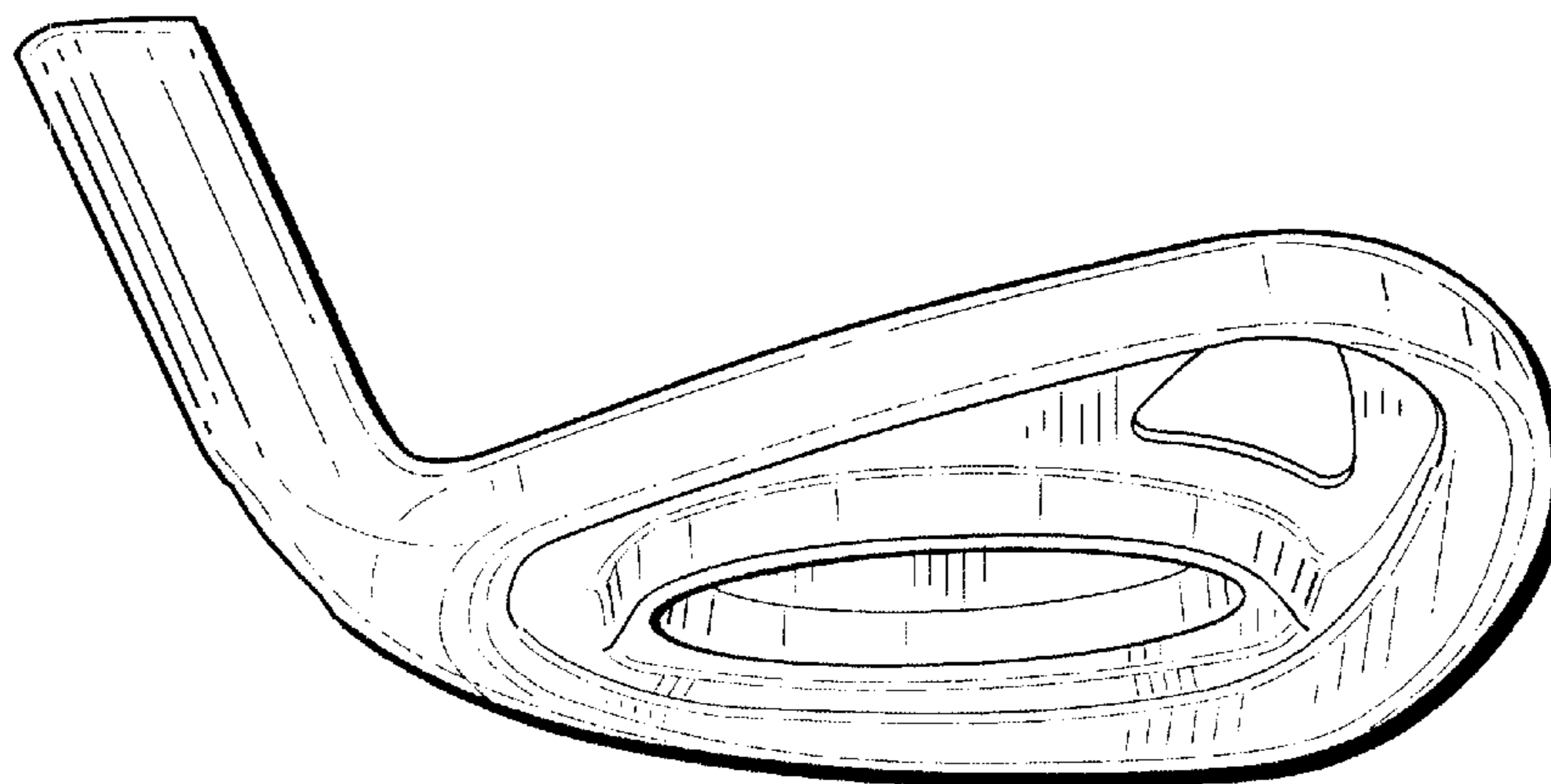

Fig. 7