

US00D541352S

(12) **United States Design Patent**
Andersen

(10) **Patent No.:** **US D541,352 S**
(45) **Date of Patent:** **** Apr. 24, 2007**

(54) **SET OF COLLECTIBLE GAME PIECES**

(76) Inventor: **Jacob Ranis Stockholm Andersen**,
28D, Conduit Tower, 20 Conduit Road,
Hong Kong (CN)

(**) Term: **14 Years**

(21) Appl. No.: **29/226,197**

(22) Filed: **Mar. 25, 2005**

(51) **LOC (8) Cl.** **21-01**

(52) **U.S. Cl.** **D21/386**

(58) **Field of Classification Search** D21/334–368,
D21/385–390; 273/236–288, 336, 339; 473/569,
473/588, 589

See application file for complete search history.

(56) **References Cited**

U.S. PATENT DOCUMENTS

1,097,035	A	*	5/1914	Lee	273/336
1,683,643	A	*	9/1928	Wittmaak	473/589
D86,590	S	*	3/1932	Adams	D21/387
D152,984	S	*	3/1949	Koches	D21/387
3,507,496	A	*	4/1970	Miller	273/339
3,602,509	A	*	8/1971	Curtiss et al.	273/339
D275,580	S	*	9/1984	Bowen	D21/387
4,880,242	A	*	11/1989	White	273/336

* cited by examiner

Primary Examiner—Sandra L. Morris

(74) *Attorney, Agent, or Firm*—DLA Piper US LLP

(57) **CLAIM**

The ornamental design for a set of collectible game pieces,
as shown and described.

DESCRIPTION

FIG. 1 is a front plan view of a first game piece, of which
the rear plan view is a mirror image;

FIG. 2 is a top view thereof, which is identical to the bottom
view thereof;

FIG. 3 is a right side view thereof;

FIG. 4 is a left side view thereof;

FIG. 5 is a front plan view of a second game piece, of which
the rear plan view is a mirror image;

FIG. 6 is a right side view thereof;

FIG. 7 is a left side view thereof;

FIG. 8 is a front plan view of a third game piece, of which
the rear plan view is a mirror image;

FIG. 9 is a top view thereof, which is identical to the bottom
view thereof;

FIG. 10 is a right side view thereof;

FIG. 11 is a left side view thereof;

FIG. 12 is a front plan view of a fourth game piece which
is identical to the rear plan view;

FIG. 13 is a top view thereof, which is identical to the
bottom view thereof;

FIG. 14 is a front plan view of a fifth game piece, of which
the rear plan view is a mirror image;

FIG. 15 is a top view thereof; which is identical to the
bottom view thereof;

FIG. 16 is a right side view thereof;

FIG. 17 is a left side view thereof;

FIG. 18 is a front plan view of a sixth game piece, of which
the rear plan view is a mirror image;

FIG. 19 is a right side view thereof;

FIG. 20 is a left side view thereof;

FIG. 21 is a front plan view of a seventh game piece, of
which the rear plan view is a mirror image;

FIG. 22 is a right side view thereof;

FIG. 23 is a left side view thereof;

FIG. 24 is a front plan view of an eighth game piece, of
which the rear plan view is a mirror image;

FIG. 25 is a top view thereof;

FIG. 26 is a bottom view thereof;

FIG. 27 is a right side view thereof;

FIG. 28 is a left side view thereof;

FIG. 29 is a front plan view of a ninth game piece, of which
the rear plan view is a mirror image;

FIG. 30 is a right side view thereof;

FIG. 31 is a left side view thereof;

FIG. 32 is a front plan view of a tenth game piece, of which
the rear plan view is a mirror image;

FIG. 33 is a top view thereof, which is identical to the
bottom view thereof;

FIG. 34 is a right side view thereof;

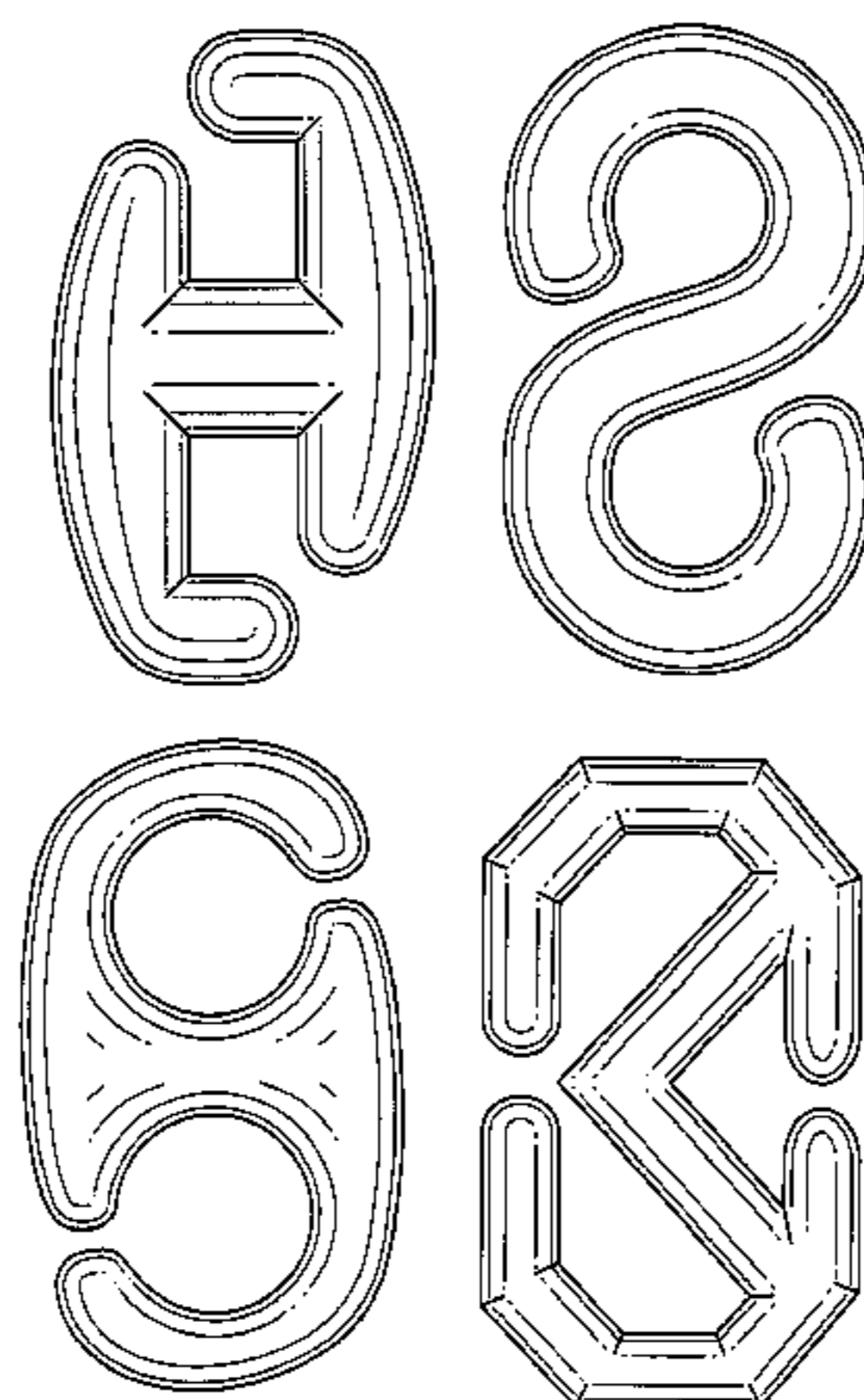

FIG. 35 is a left side view thereof;
 FIG. 36 is a front plan view of an eleventh game piece, of which the rear plan view is a mirror image;
 FIG. 37 is a right side view thereof;
 FIG. 38 is a left side view thereof;
 FIG. 39 is a front plan view of a twelfth game piece, of which the rear plan view is a mirror image;
 FIG. 40 is a top view thereof, which is identical to the bottom view thereof;
 FIG. 41 is a right side view thereof;
 FIG. 42 is a left side view thereof;
 FIG. 43 is a front plan view of a thirteenth game piece;
 FIG. 44 is a top view thereof, which is identical to the bottom view thereof;
 FIG. 45 is a right side view thereof;
 FIG. 46 is a left side view thereof;
 FIG. 47 is a rear plan view thereof;
 FIG. 48 is a front plan view of a fourteenth game piece;
 FIG. 49 is a right side view thereof;
 FIG. 50 is a rear plan view thereof;
 FIG. 51 is a front plan view of a fifteenth game piece;
 FIG. 52 is a top view thereof, which is identical to the bottom view thereof;
 FIG. 53 is a right side view thereof;
 FIG. 54 is a rear plan view thereof;
 FIG. 55 is a front plan view of a sixteenth game piece, of which the rear plan view is a mirror image;
 FIG. 56 is a top view thereof, which is identical to the bottom view thereof;
 FIG. 57 is a front plan view of a seventeenth game piece, of which the rear plan view is a mirror image;
 FIG. 58 is a right side view thereof;
 FIG. 59 is a left side view thereof;
 FIG. 60 is a front plan view of an eighteenth game piece;
 FIG. 61 is a left side view thereof;
 FIG. 62 is a rear plan view thereof;
 FIG. 63 is a front plan view of a nineteenth game piece;
 FIG. 64 is a right side view thereof;
 FIG. 65 is a left side view thereof;
 FIG. 66 is a rear plan view thereof;
 FIG. 67 is a front plan view of a twentieth game piece;
 FIG. 68 is a right side view thereof;
 FIG. 69 is a rear plan view thereof;
 FIG. 70 is a front plan view of a twenty-first game piece, of which the rear plan view is a mirror image;
 FIG. 71 is a right side view thereof;
 FIG. 72 is a left side view thereof;

FIG. 73 is a front plan view of a twenty-second game piece, of which the rear plan view is a mirror image;
 FIG. 74 is a right side view thereof;
 FIG. 75 is a left side view thereof;
 FIG. 76 is a front plan view of a twenty-third game piece;
 FIG. 77 is a left side view thereof;
 FIG. 78 is a rear plan view thereof;
 FIG. 79 is a front plan view of a twenty-fourth game piece, of which the rear plan view is a mirror image;
 FIG. 80 is a top view thereof
 FIG. 81 is a bottom view thereof;
 FIG. 82 is a right side view thereof;
 FIG. 83 is a left side view thereof;
 FIG. 84 is a front plan view of a twenty-fifth game piece, of which the rear plan view is a mirror image;
 FIG. 85 is a right side view thereof;
 FIG. 86 is a left side view thereof;
 FIG. 87 is a front plan view of a twenty-sixth game piece, of which the rear plan view is a mirror image;
 FIG. 88 is a right side view thereof;
 FIG. 89 is a left side view thereof;
 FIG. 90 is a front plan view of a twenty-seventh game piece;
 FIG. 91 is a right side view thereof;
 FIG. 92 is a rear plan view thereof;
 FIG. 93 is a front plan view of a twenty-eighth game piece;
 FIG. 94 is a right side view thereof;
 FIG. 95 is a left side view thereof;
 FIG. 96 is a rear plan view thereof;
 FIG. 97 is a front plan view of a twenty-ninth game piece, of which the rear plan view is a mirror image;
 FIG. 98 is a right side view thereof;
 FIG. 99 is a left side view thereof;
 FIG. 100 is a front plan view of a thirtieth game piece, of which the rear plan view is a mirror image;
 FIG. 101 is a right side view thereof;
 FIG. 102 is a left side view thereof;
 FIG. 103 is a front plan view of a thirty-first game piece, of which the rear plan view is a mirror image;
 FIG. 104 is a right side view thereof; and,
 FIG. 105 is a left side view thereof.

For each figure, the lighter gray areas toward the interior represent an elevated portion, and the darker gray areas surrounding the lighter gray areas represent a portion having a curvature away from the elevated portion, the combination of which shows the rounded character of the game piece.

1 Claim, 31 Drawing Sheets

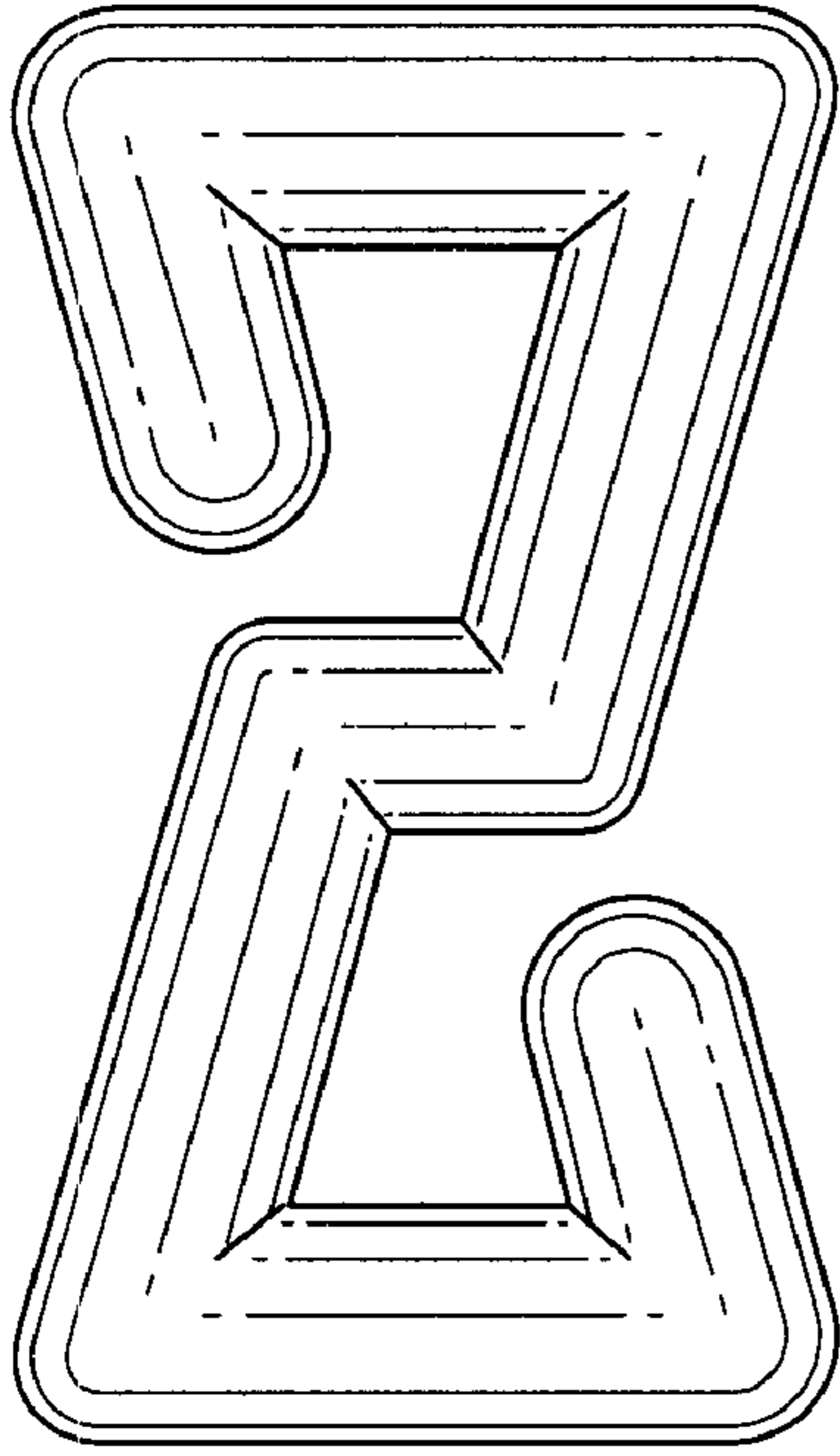

FIG. 1

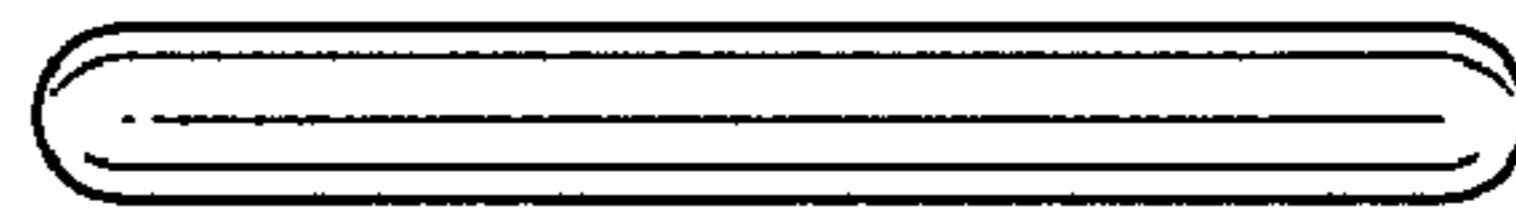

FIG. 2



FIG. 3



FIG. 4

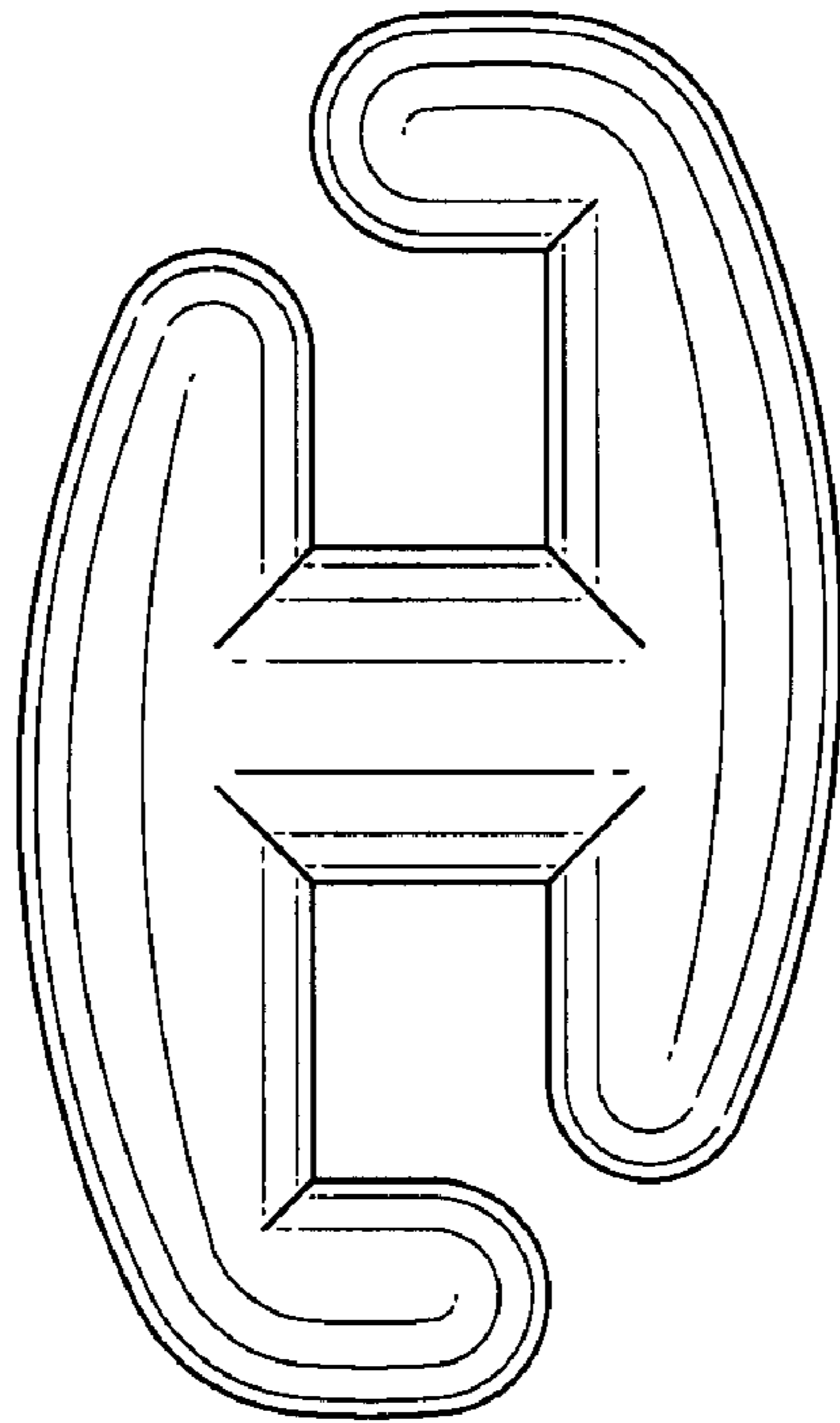

FIG. 5



FIG. 6

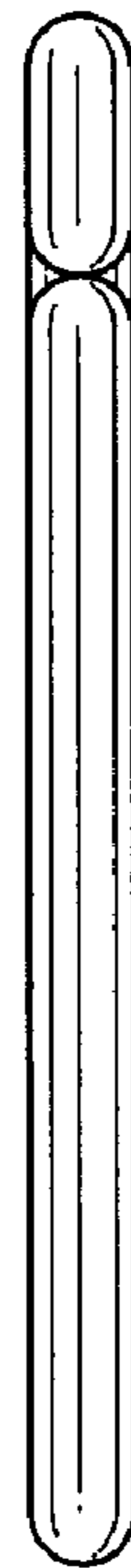

FIG. 7

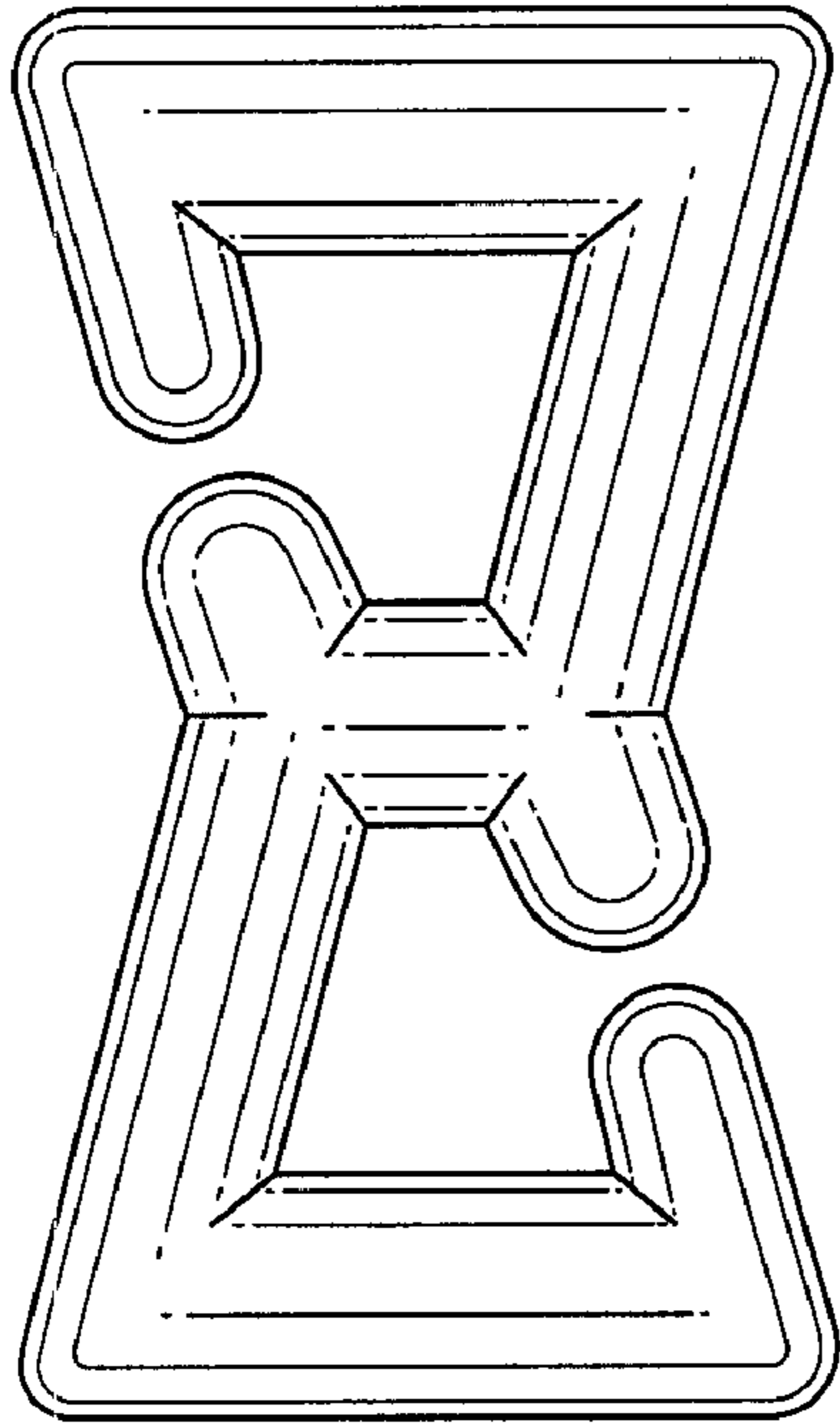

FIG. 8

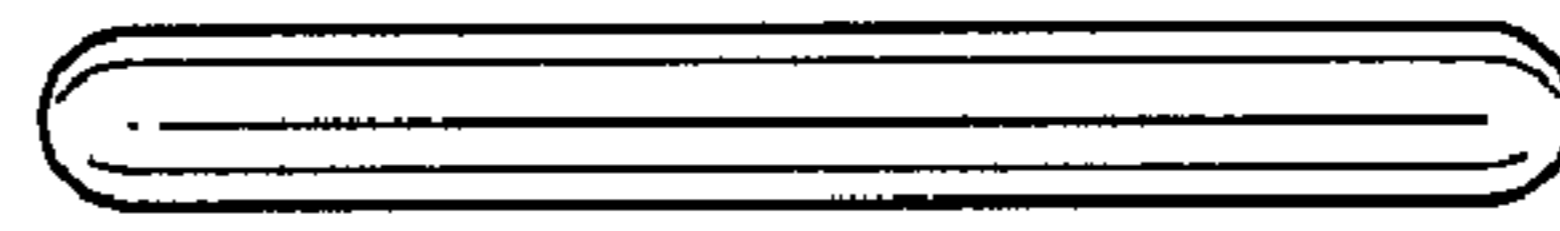

FIG. 9

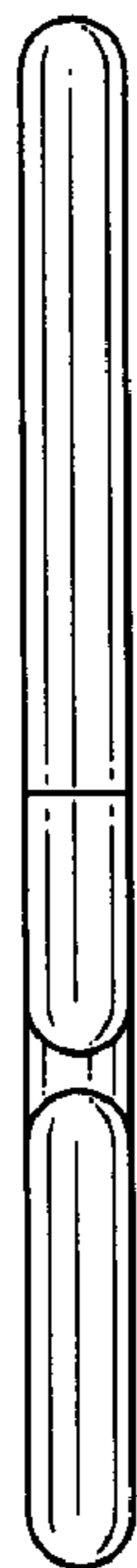

FIG. 10



FIG. 11

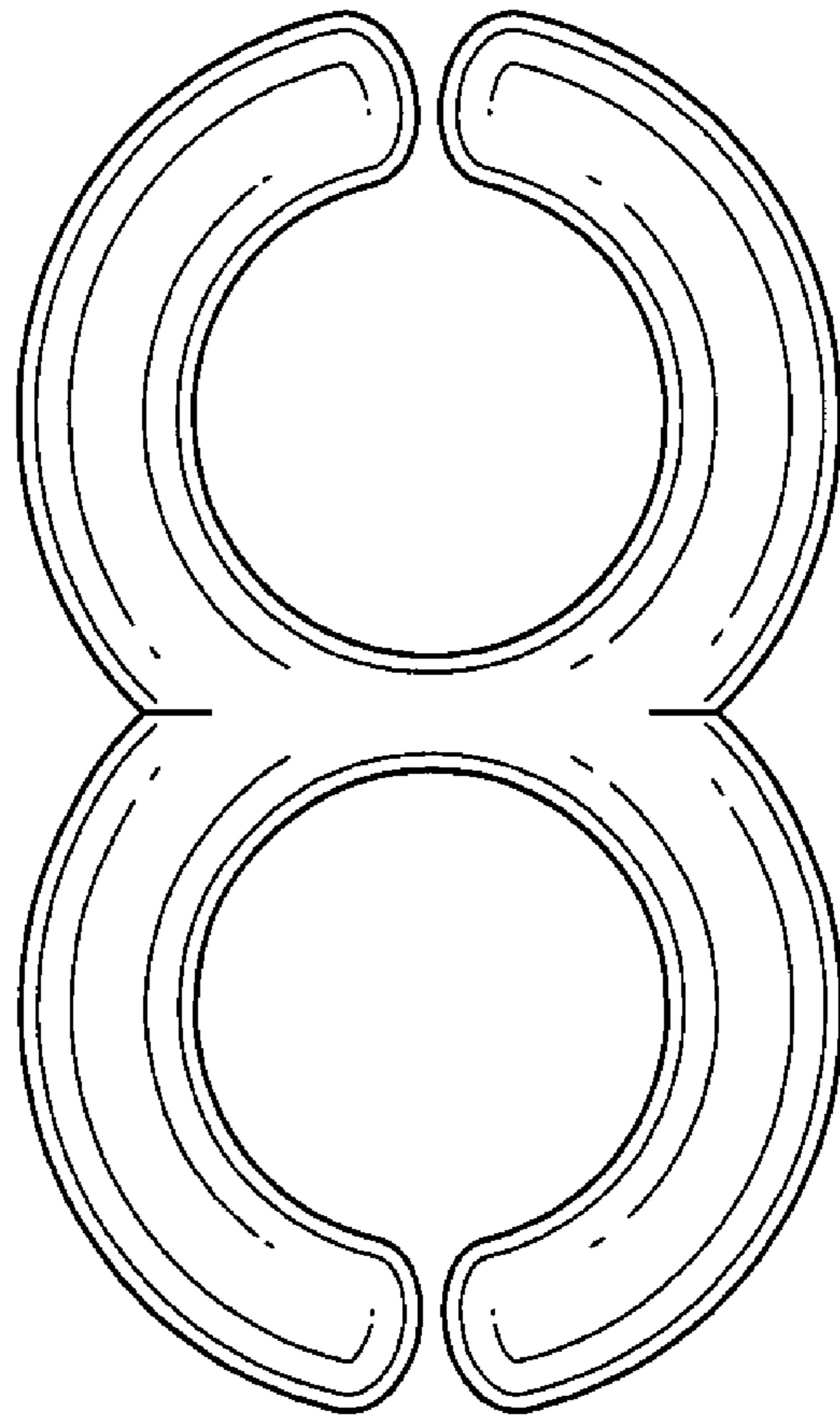

FIG. 12



FIG. 13

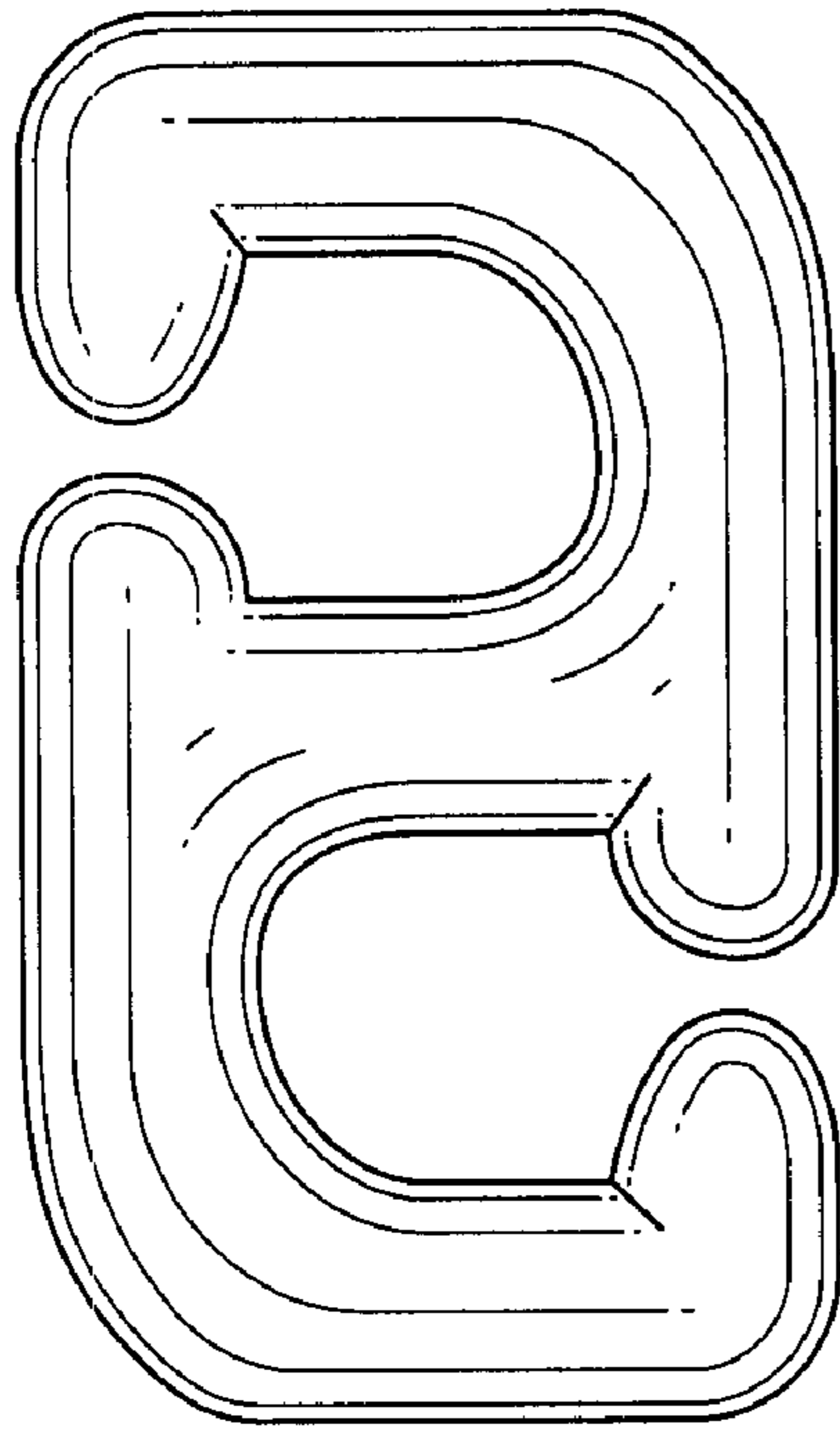

FIG. 14

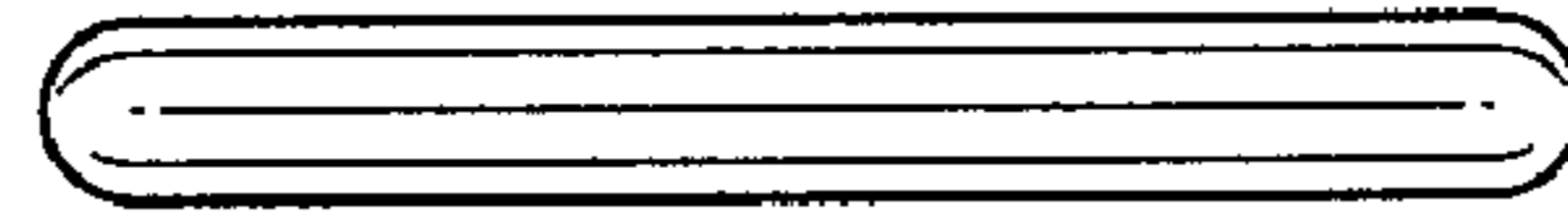

FIG. 15

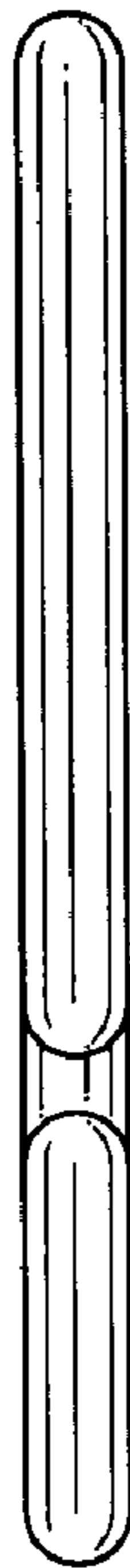

FIG. 16

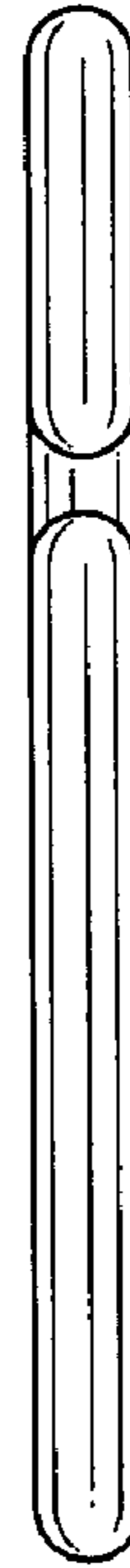

FIG. 17

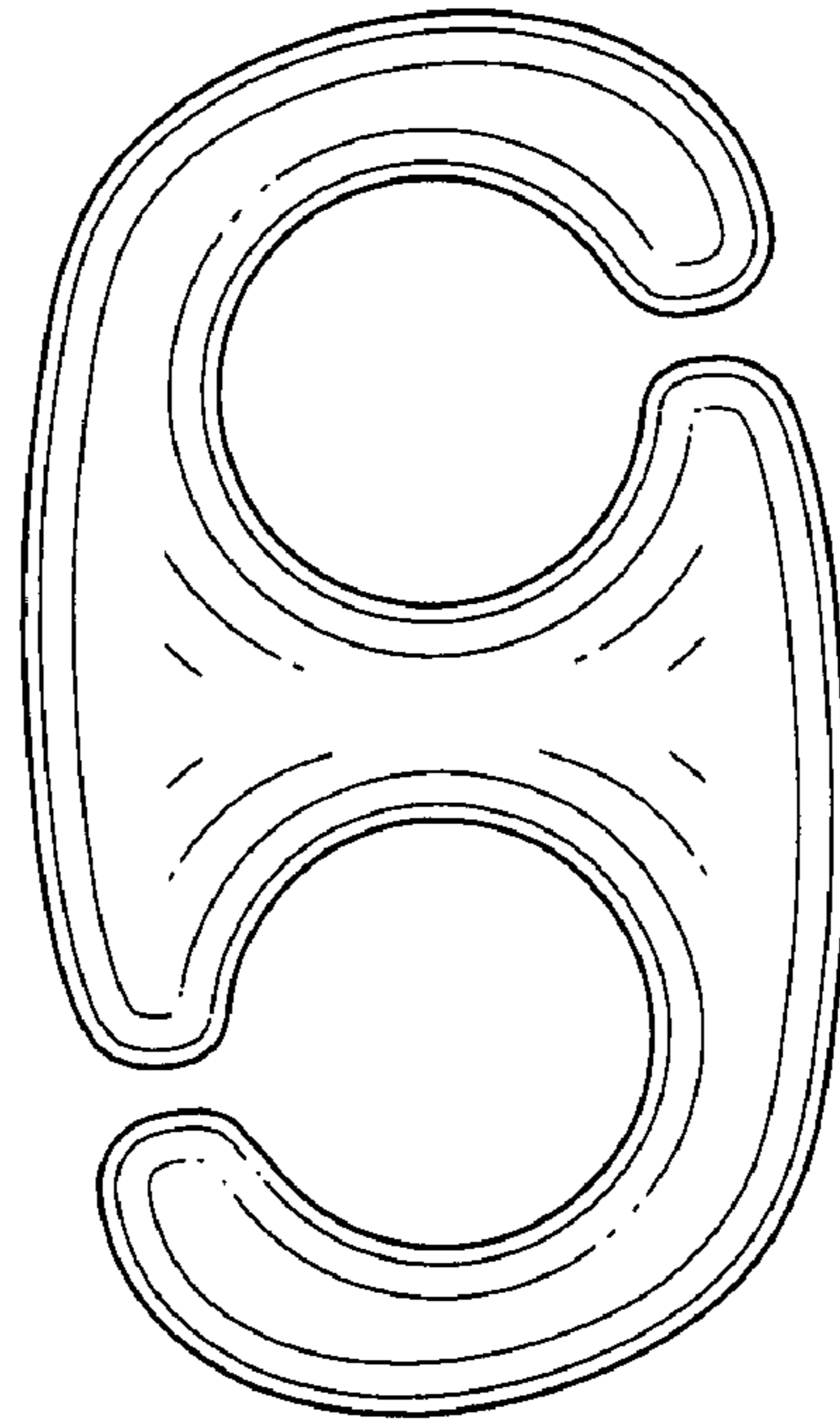

FIG. 18

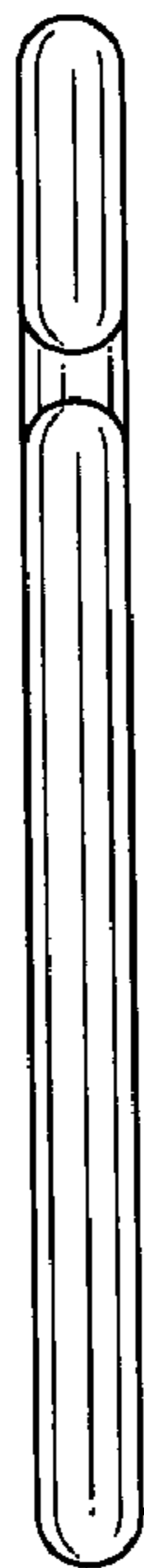

FIG. 19

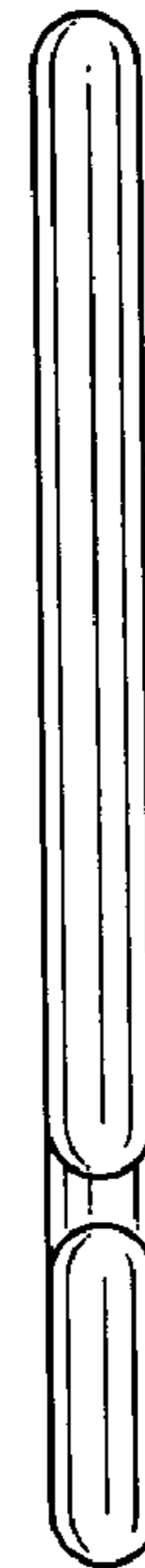

FIG. 20

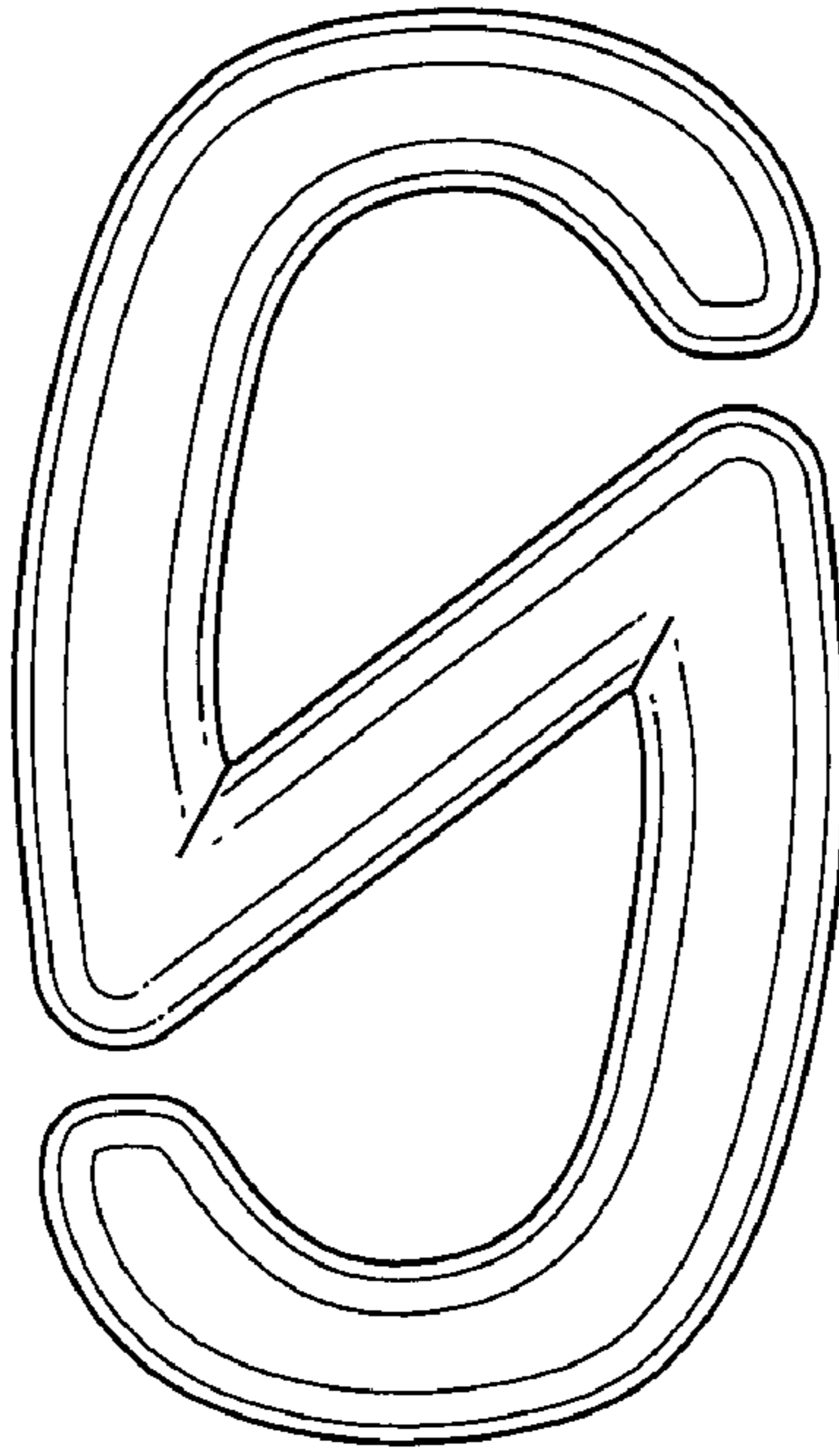

FIG. 21



FIG. 22

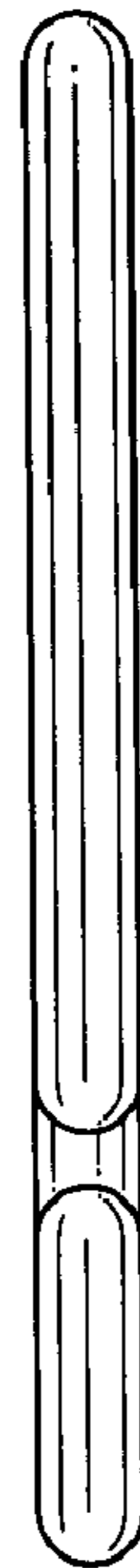

FIG. 23

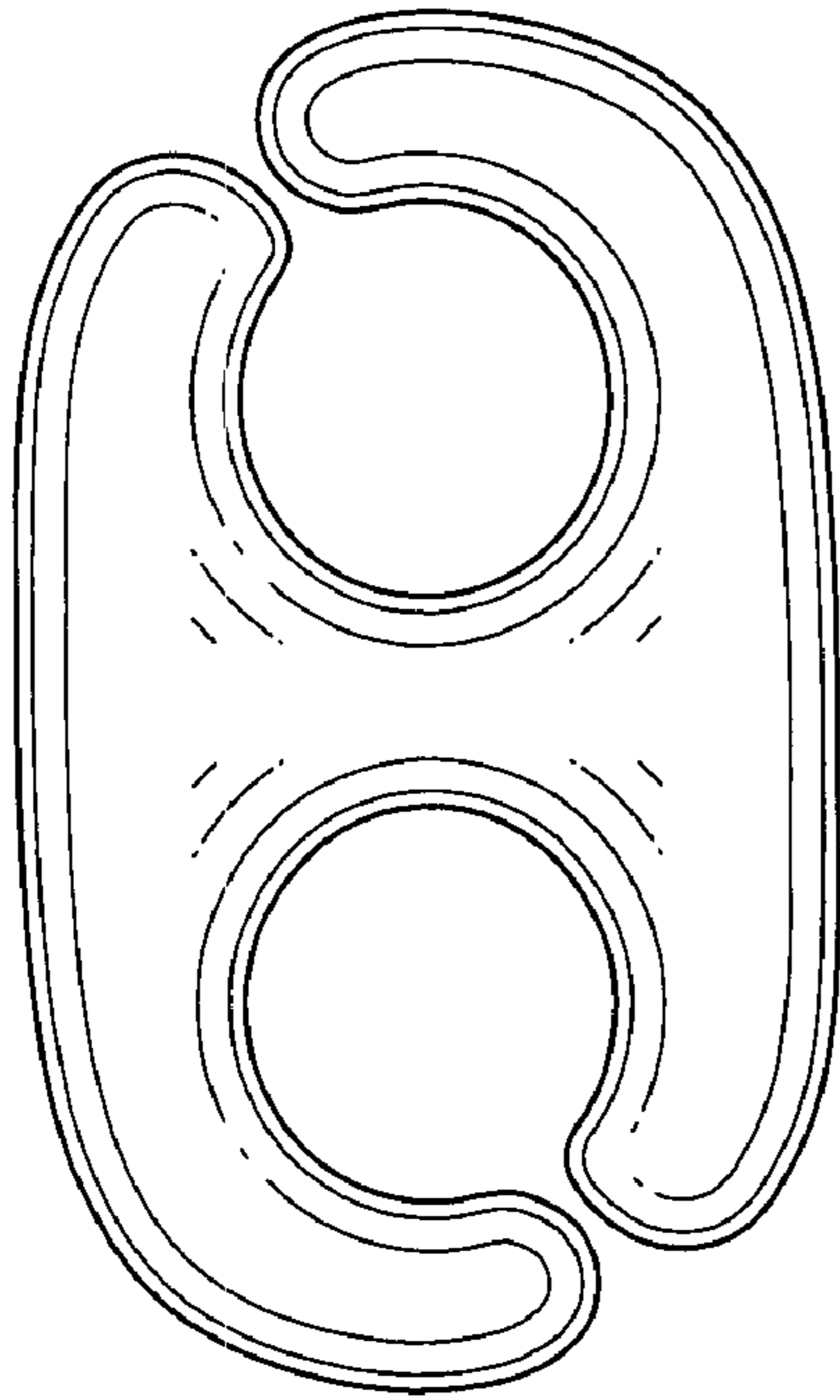

FIG. 24

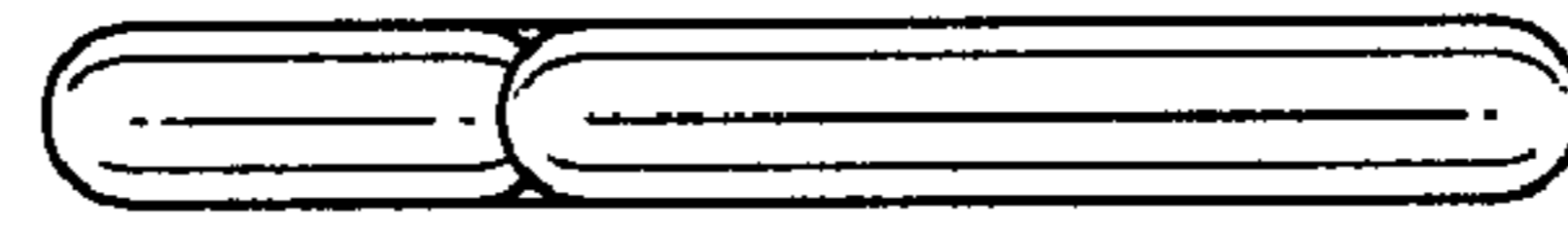

FIG. 25

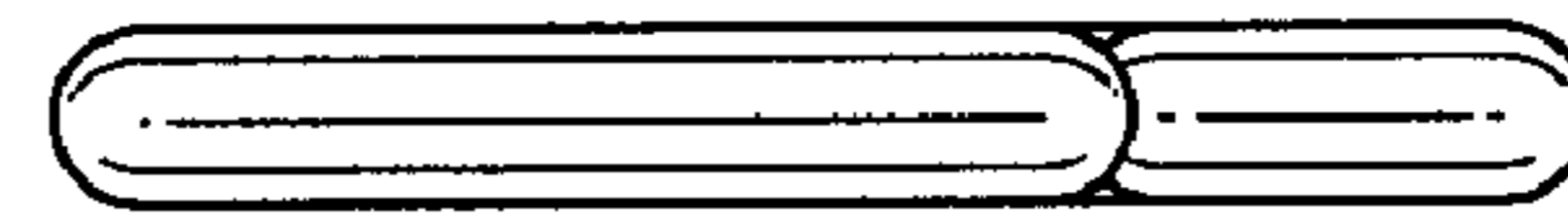

FIG. 26



FIG. 27



FIG. 28

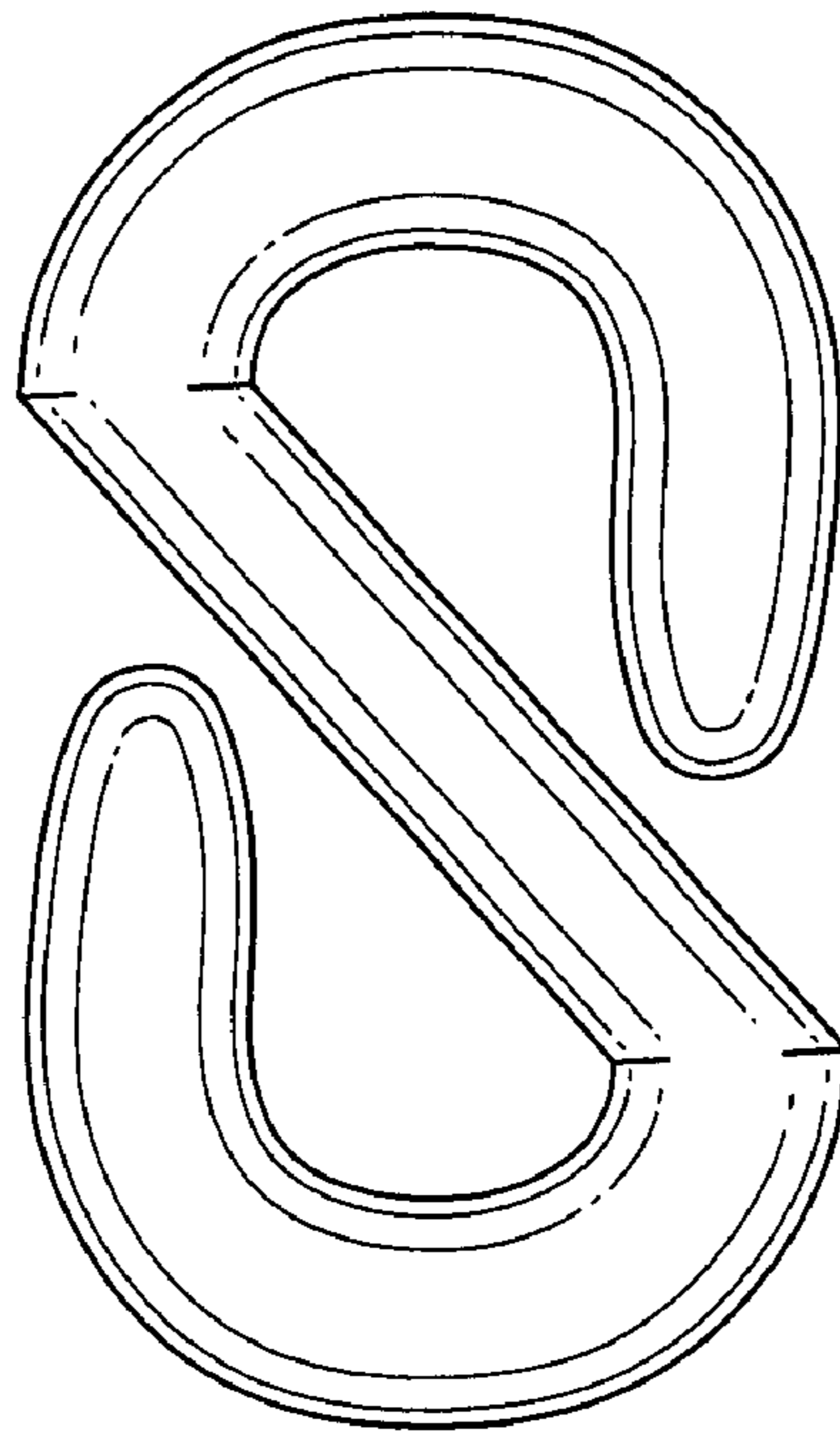

FIG. 29



FIG. 30



FIG. 31

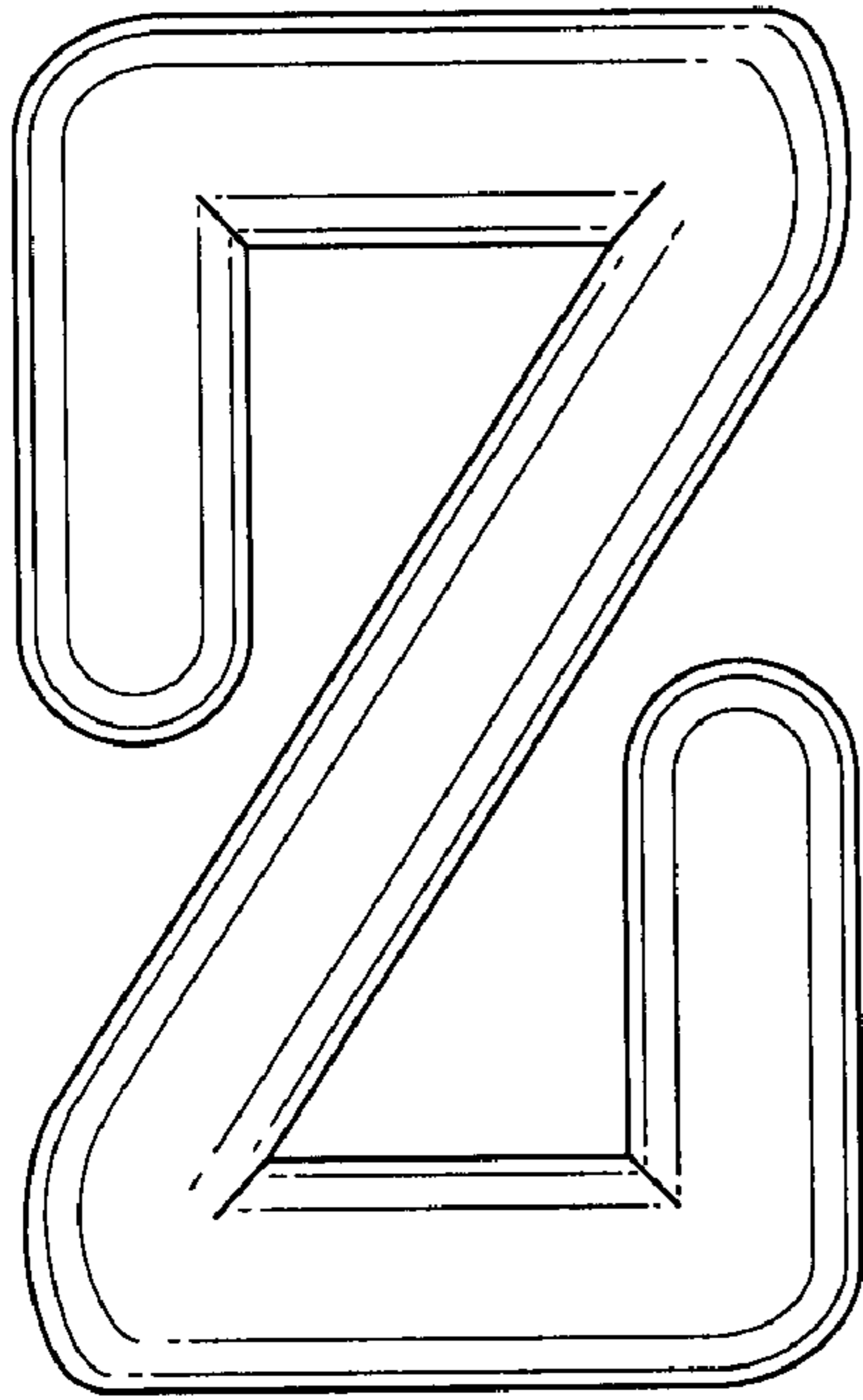

FIG. 32

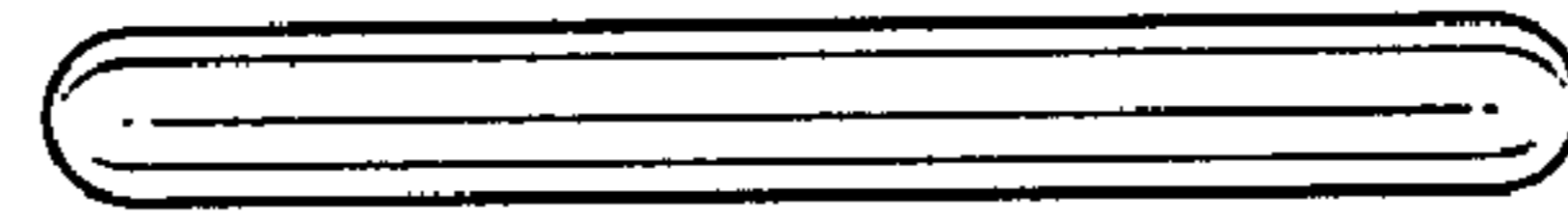

FIG. 33



FIG. 34



FIG. 35

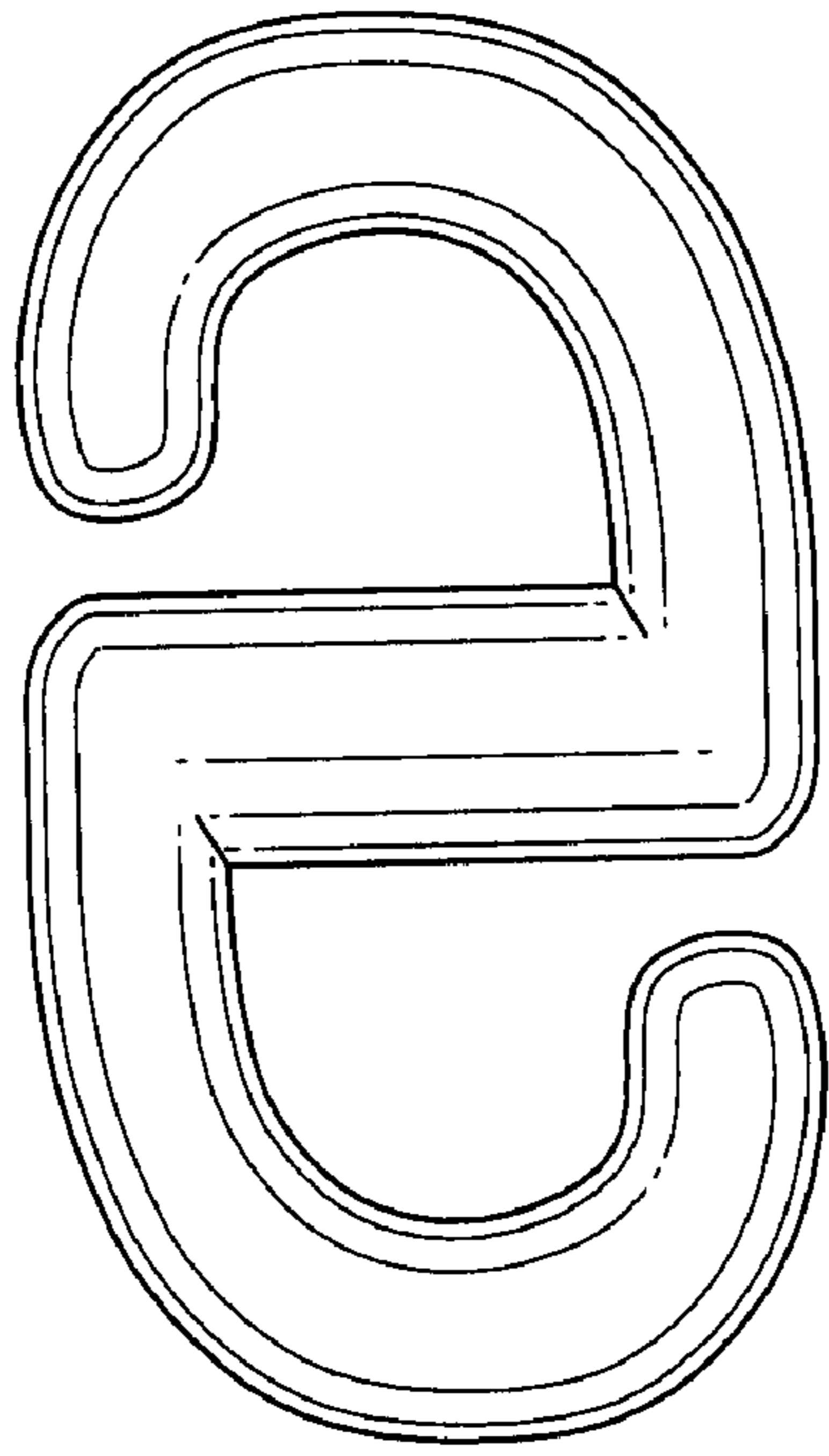

FIG. 36

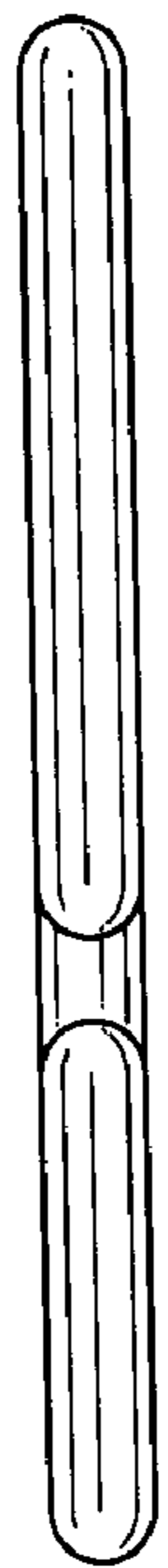

FIG. 37

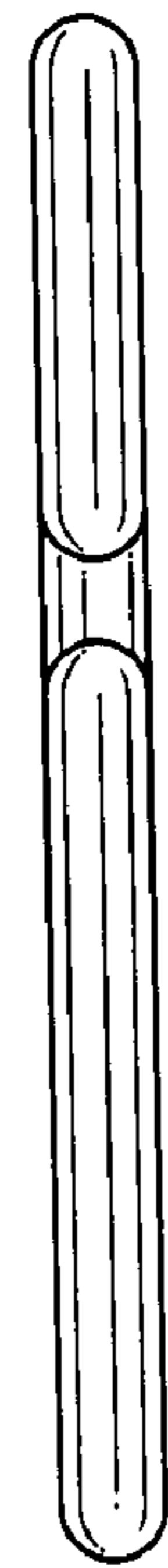

FIG. 38

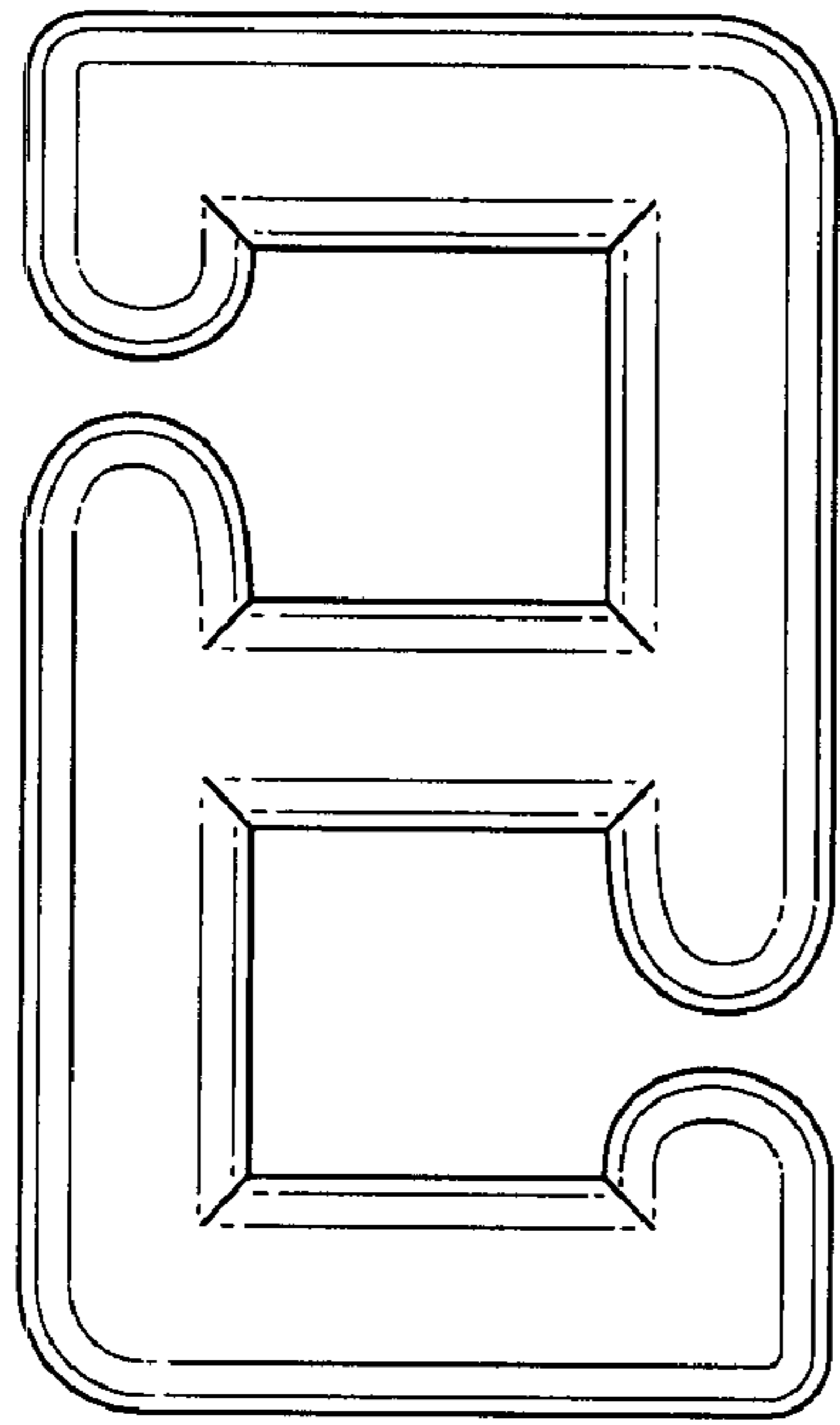

FIG. 39

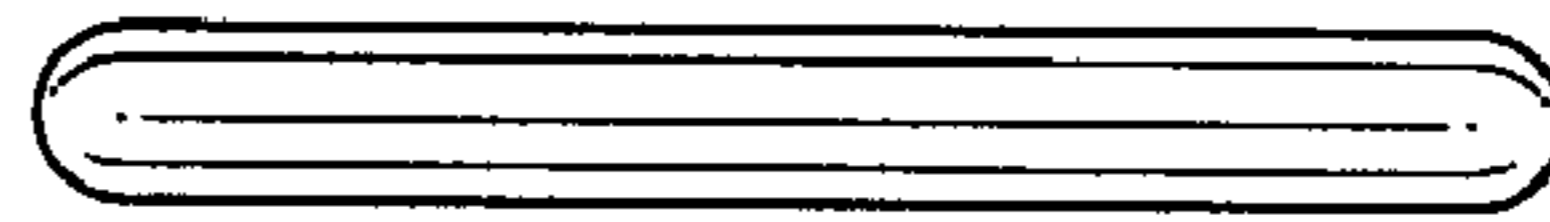

FIG. 40



FIG. 41



FIG. 42

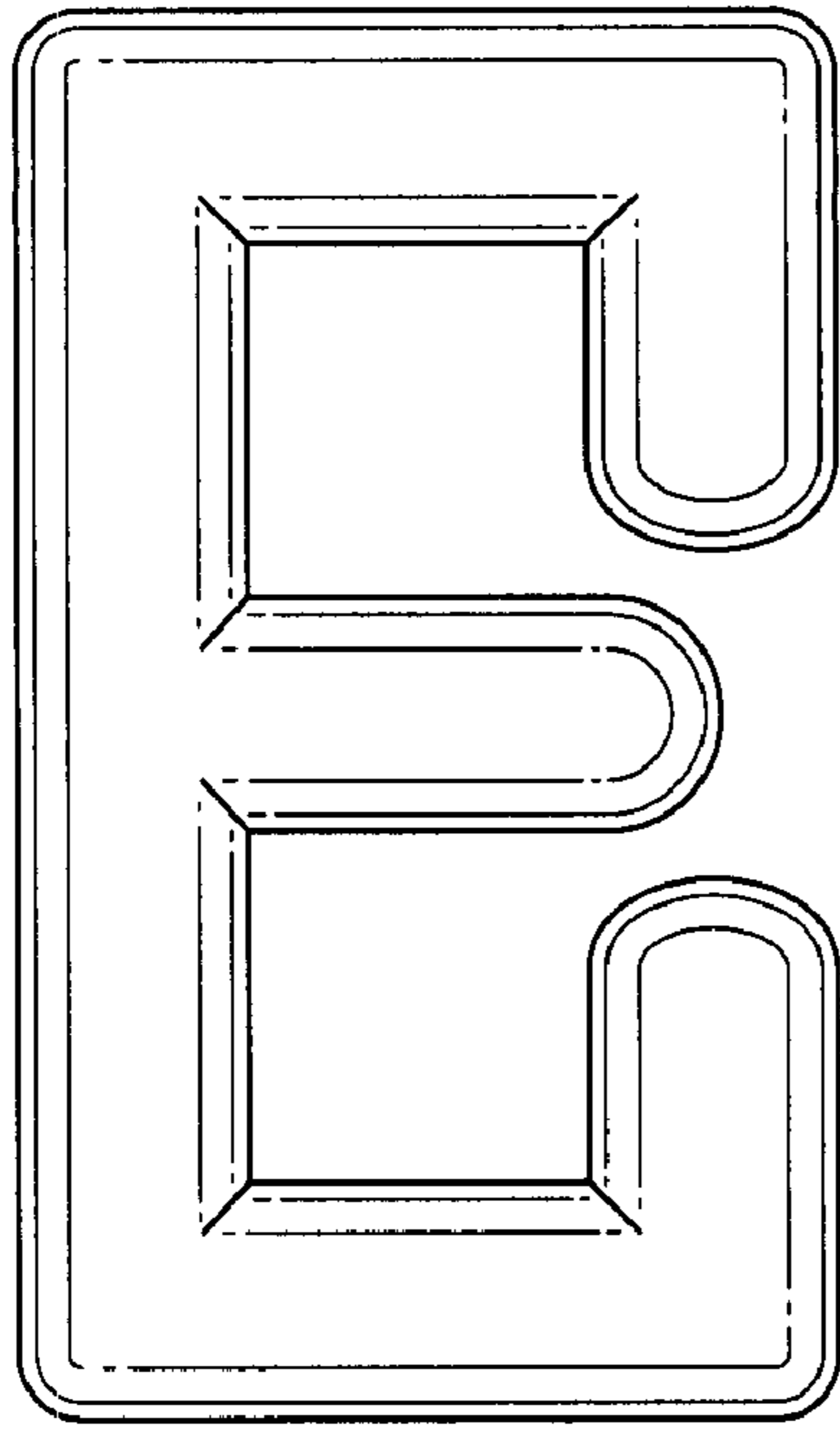

FIG. 43

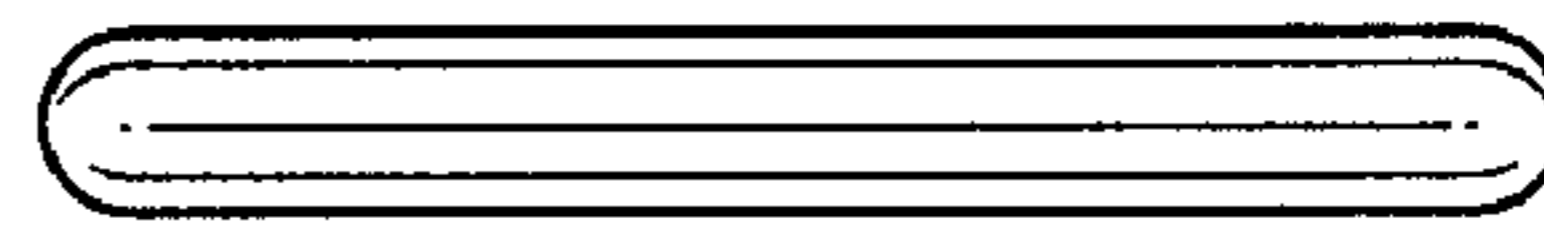

FIG. 44

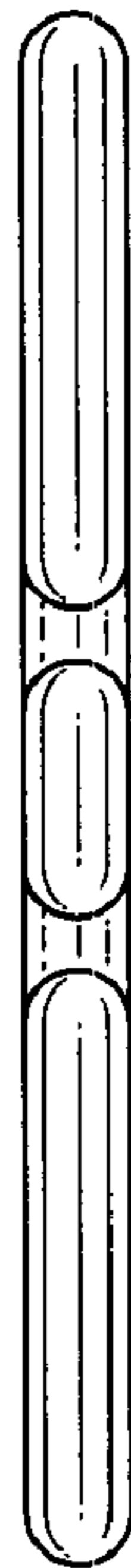

FIG. 45

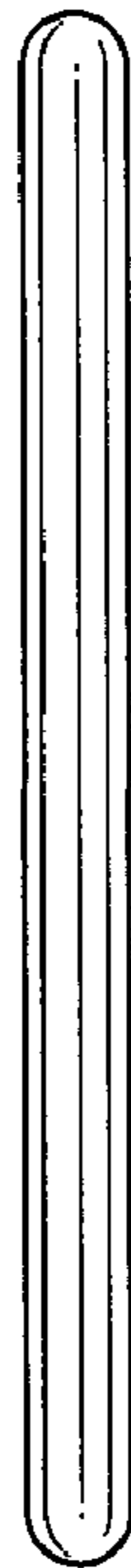

FIG. 46

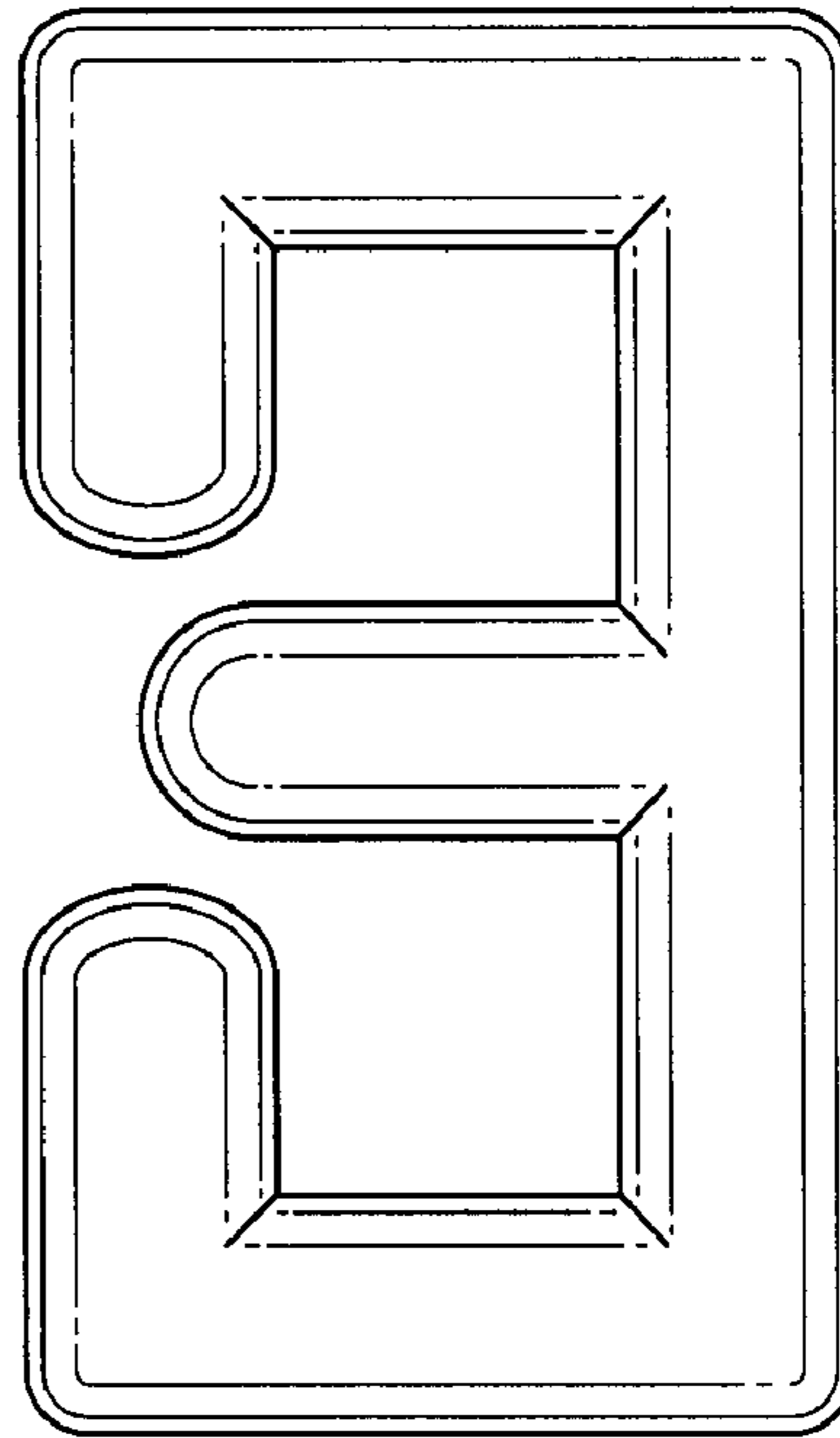

FIG. 47

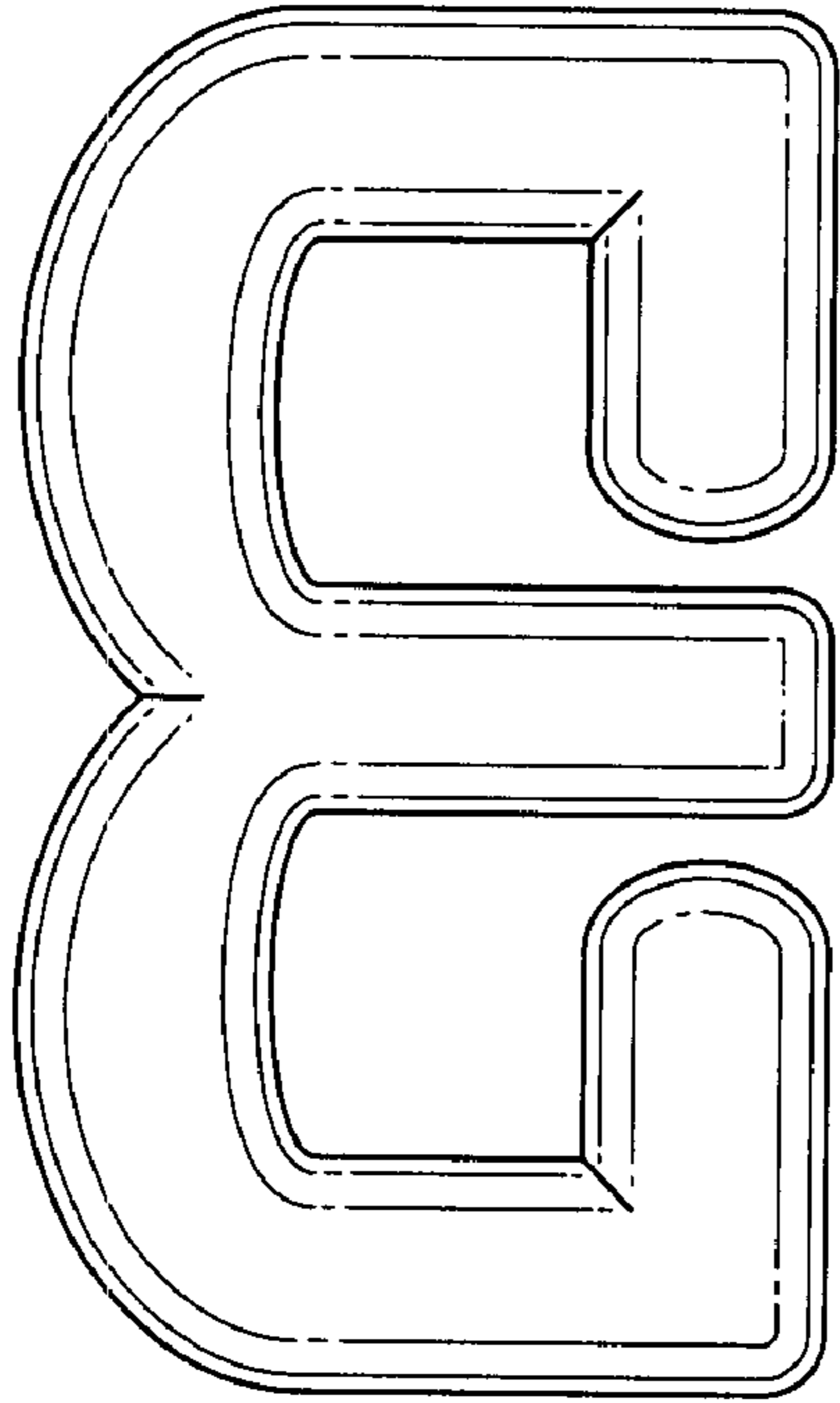

FIG. 48



FIG. 49

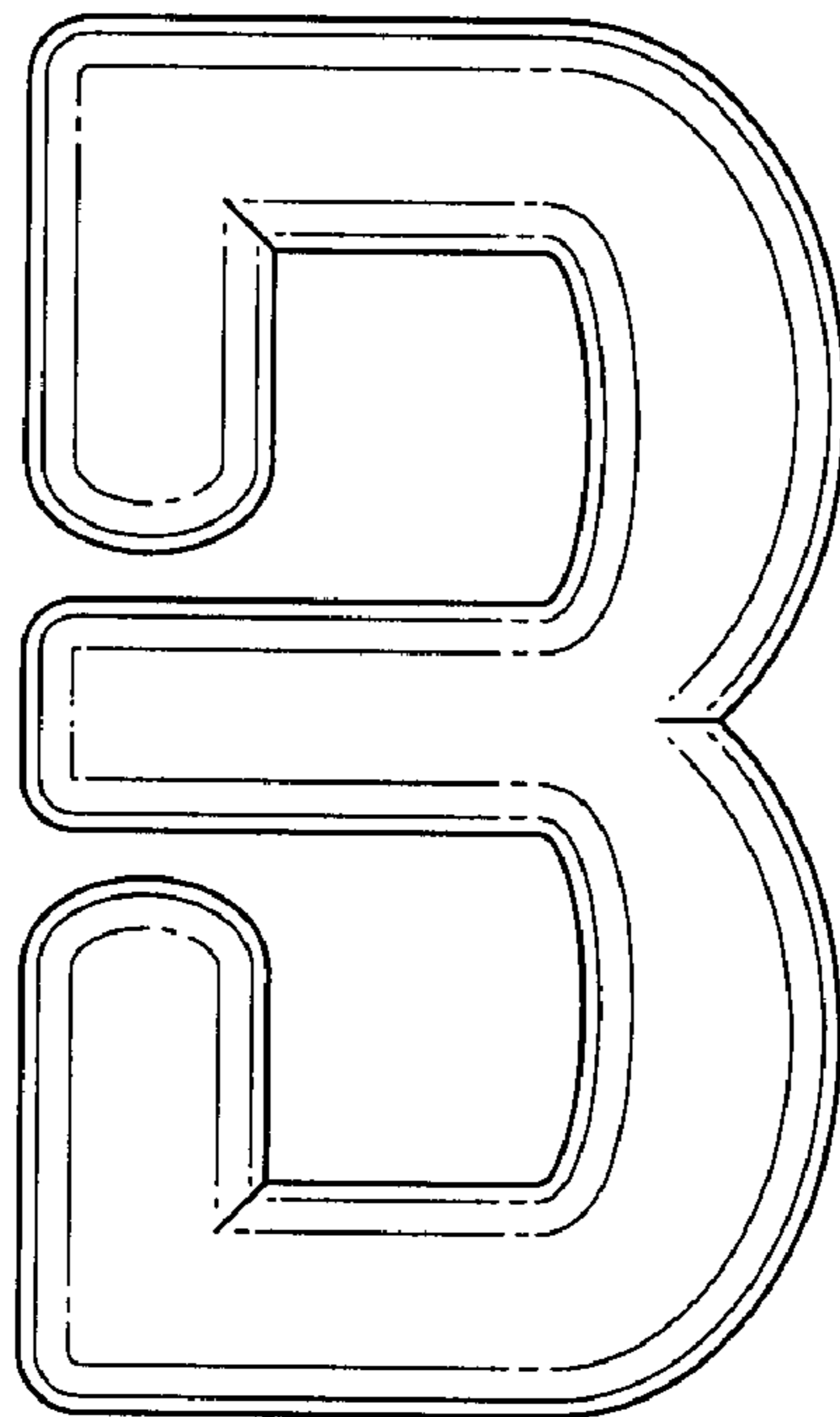

FIG. 50

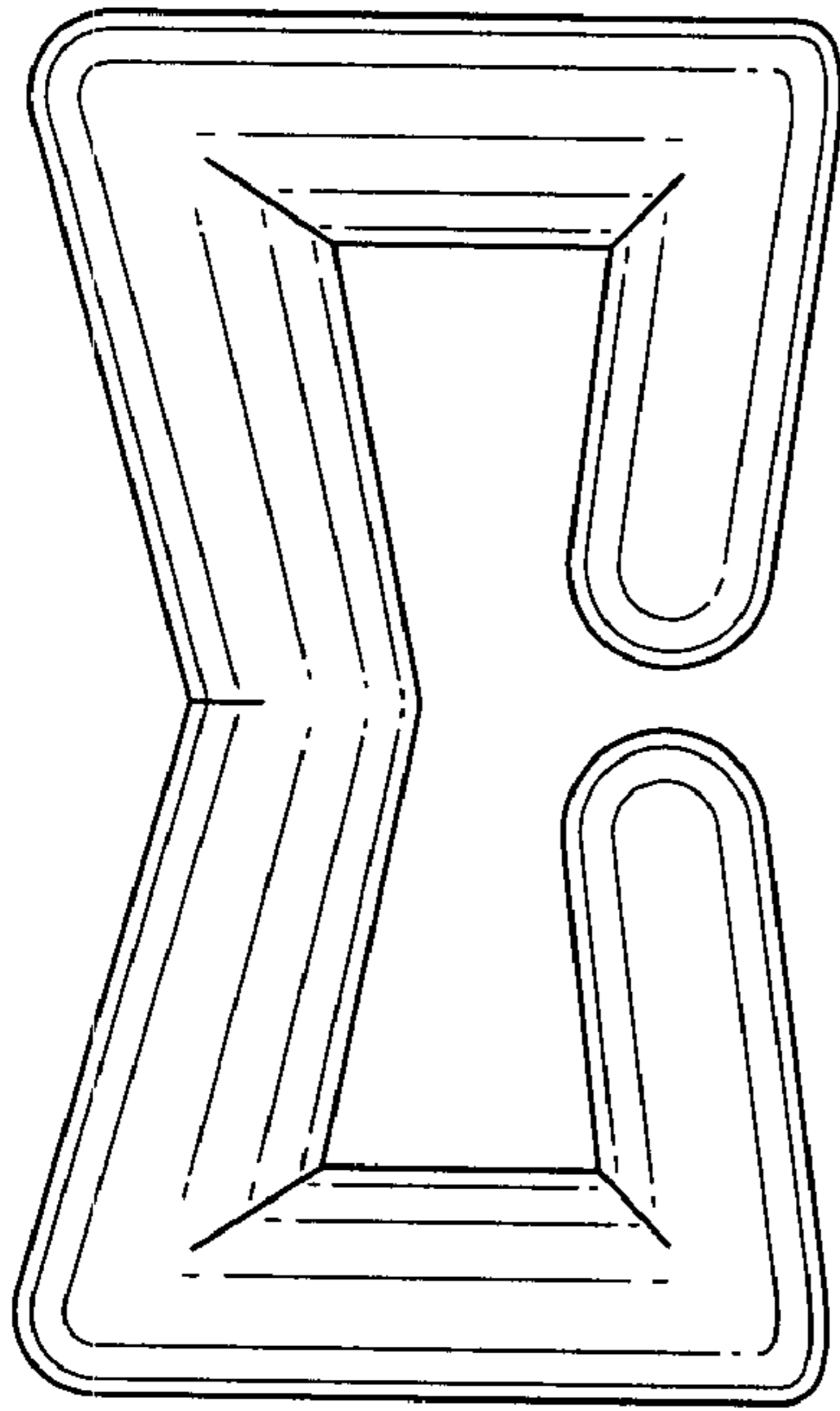

FIG. 51

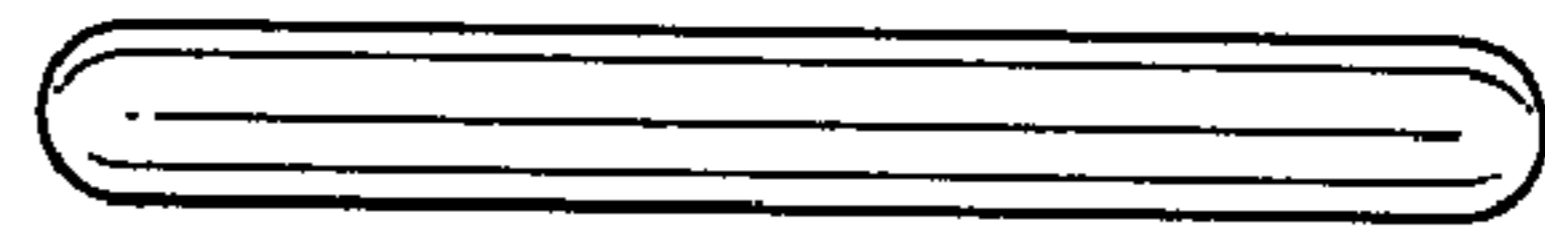

FIG. 52



FIG. 53

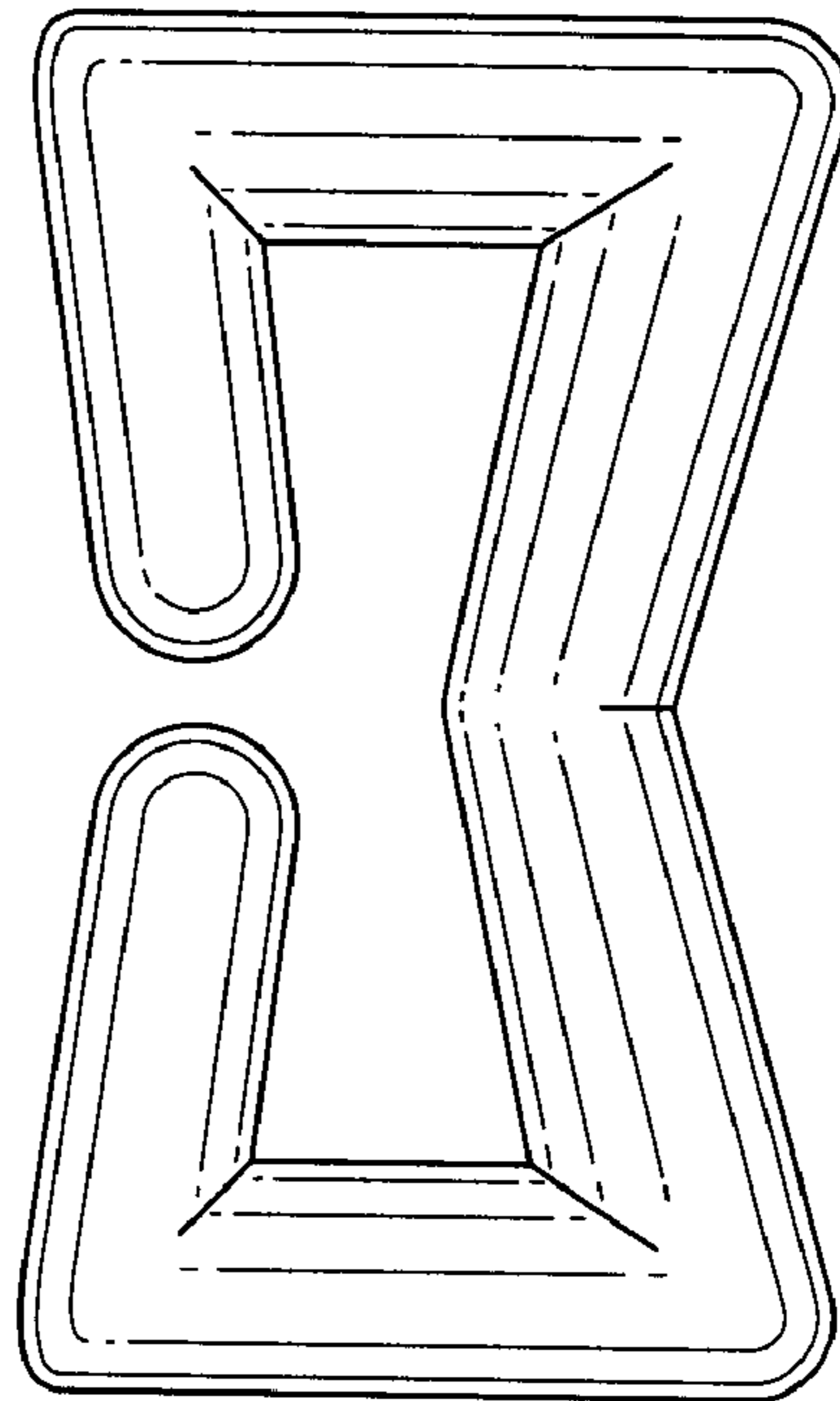

FIG. 54

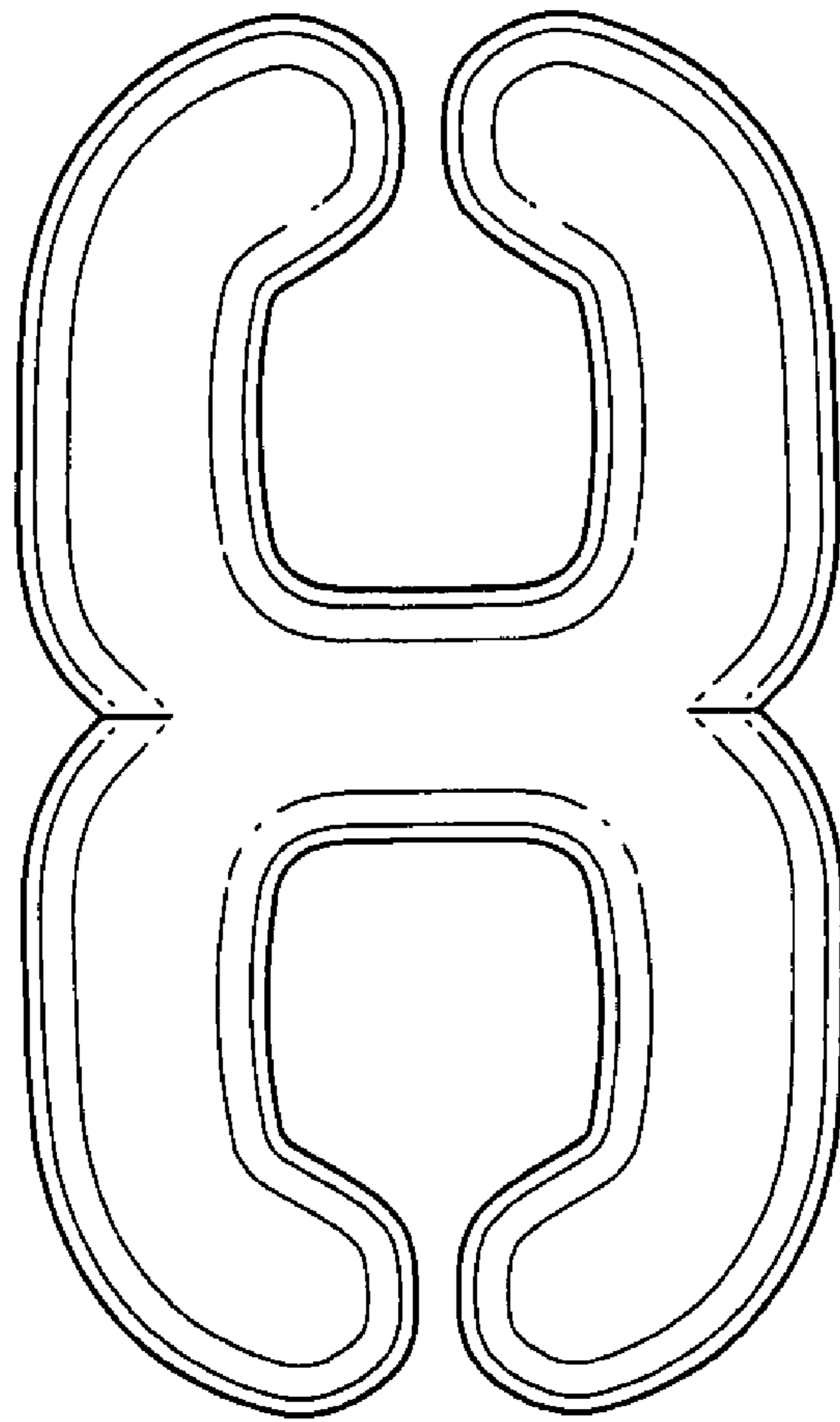

FIG. 55



FIG. 56

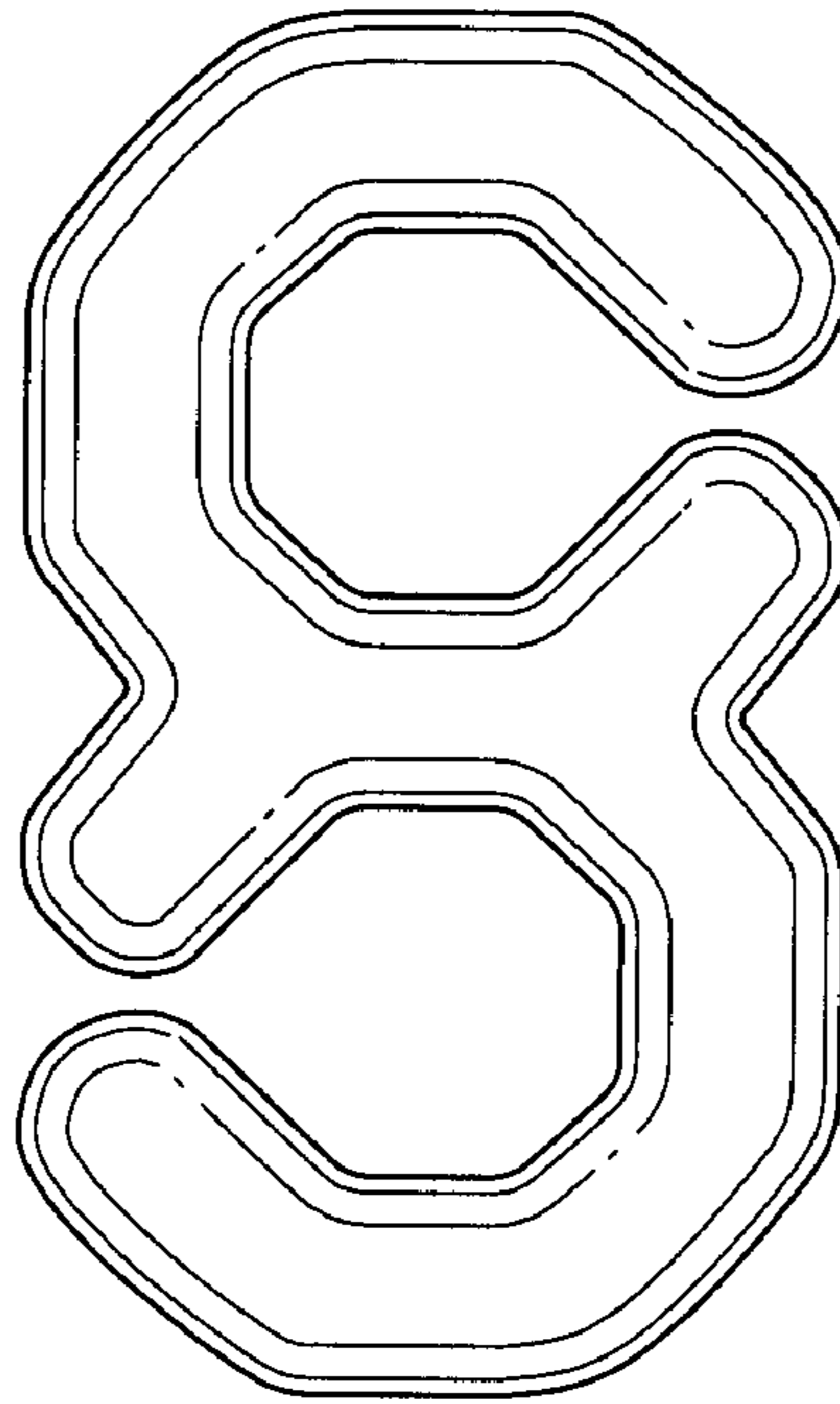

FIG. 57



FIG. 58



FIG. 59

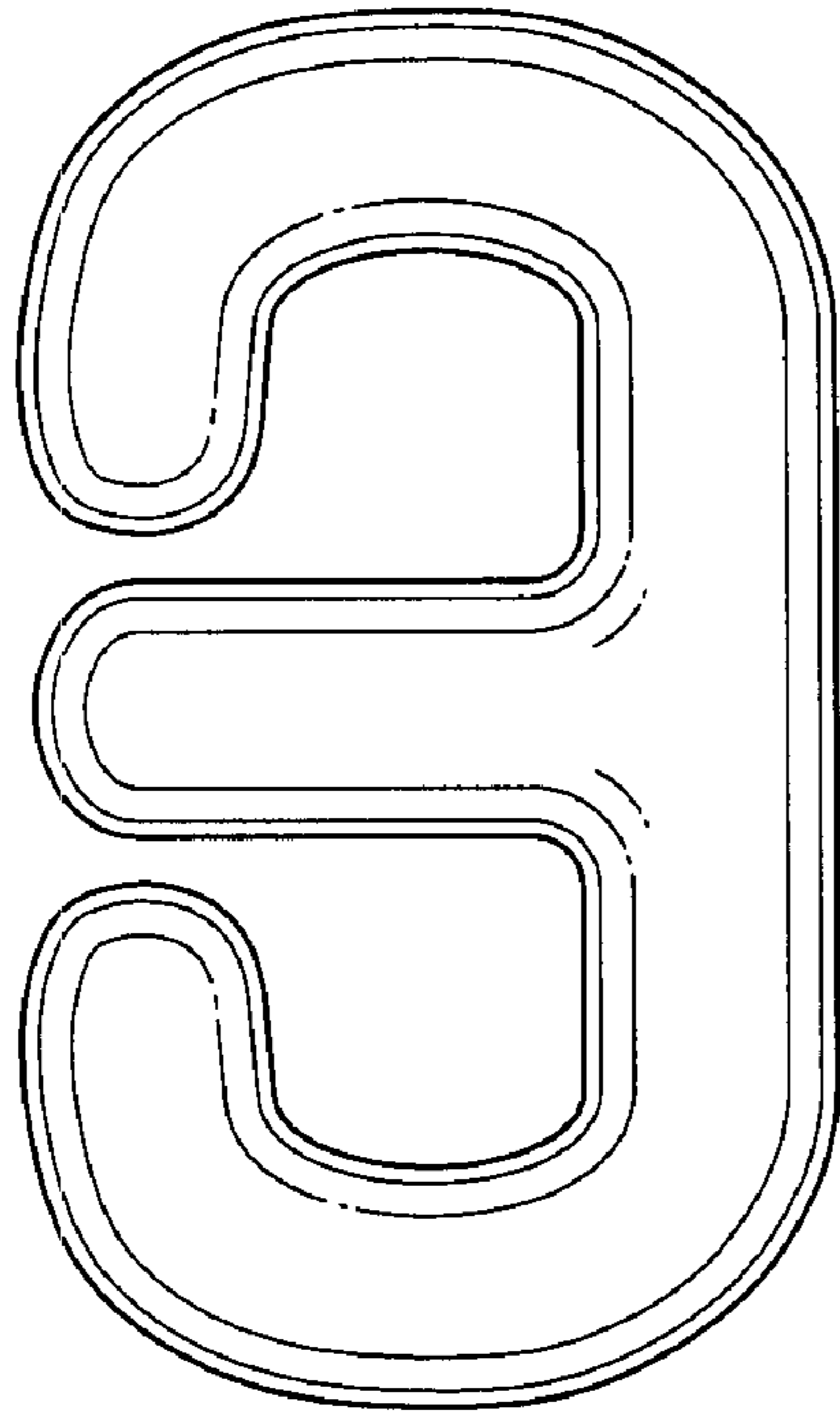

FIG. 60



FIG. 61

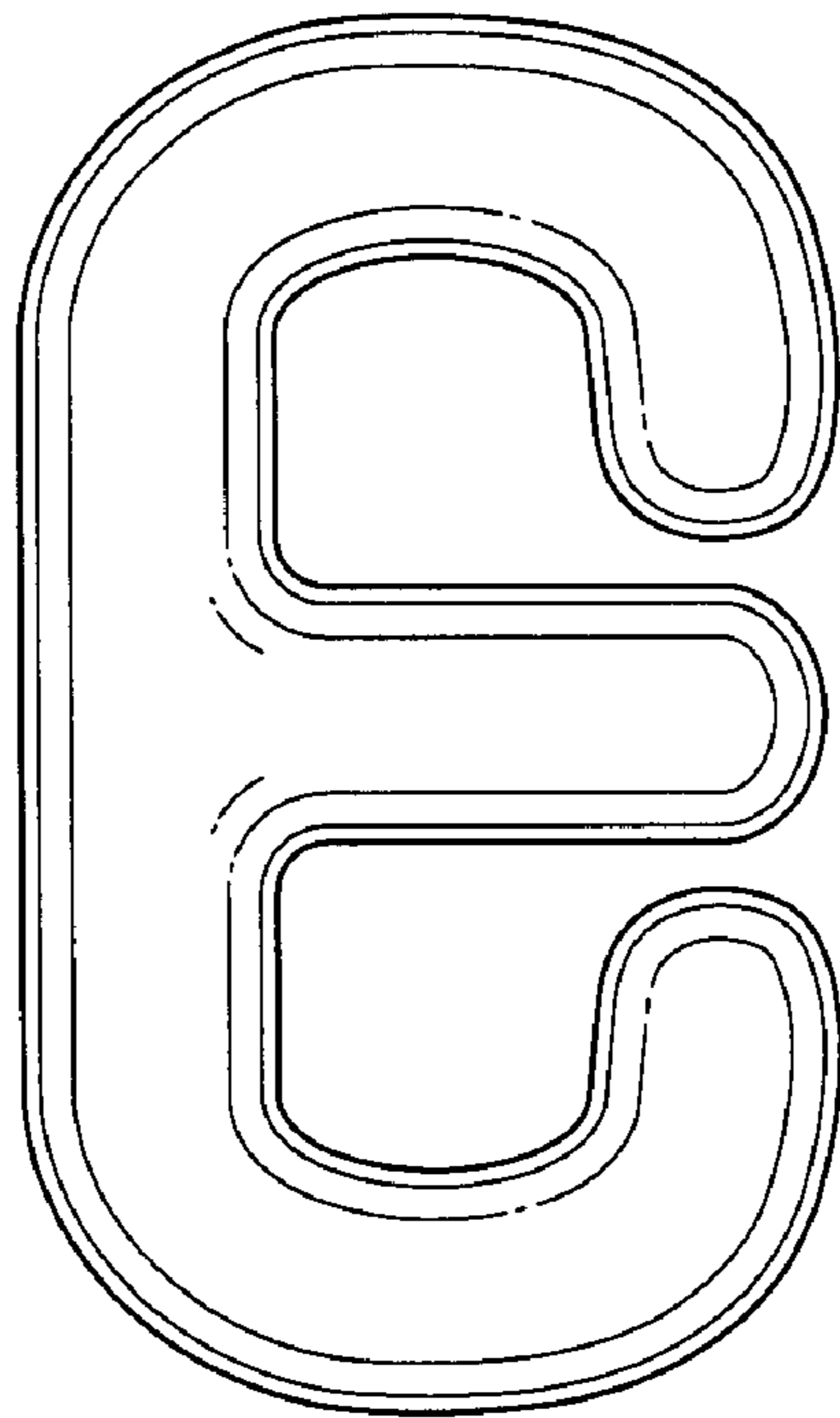

FIG. 62

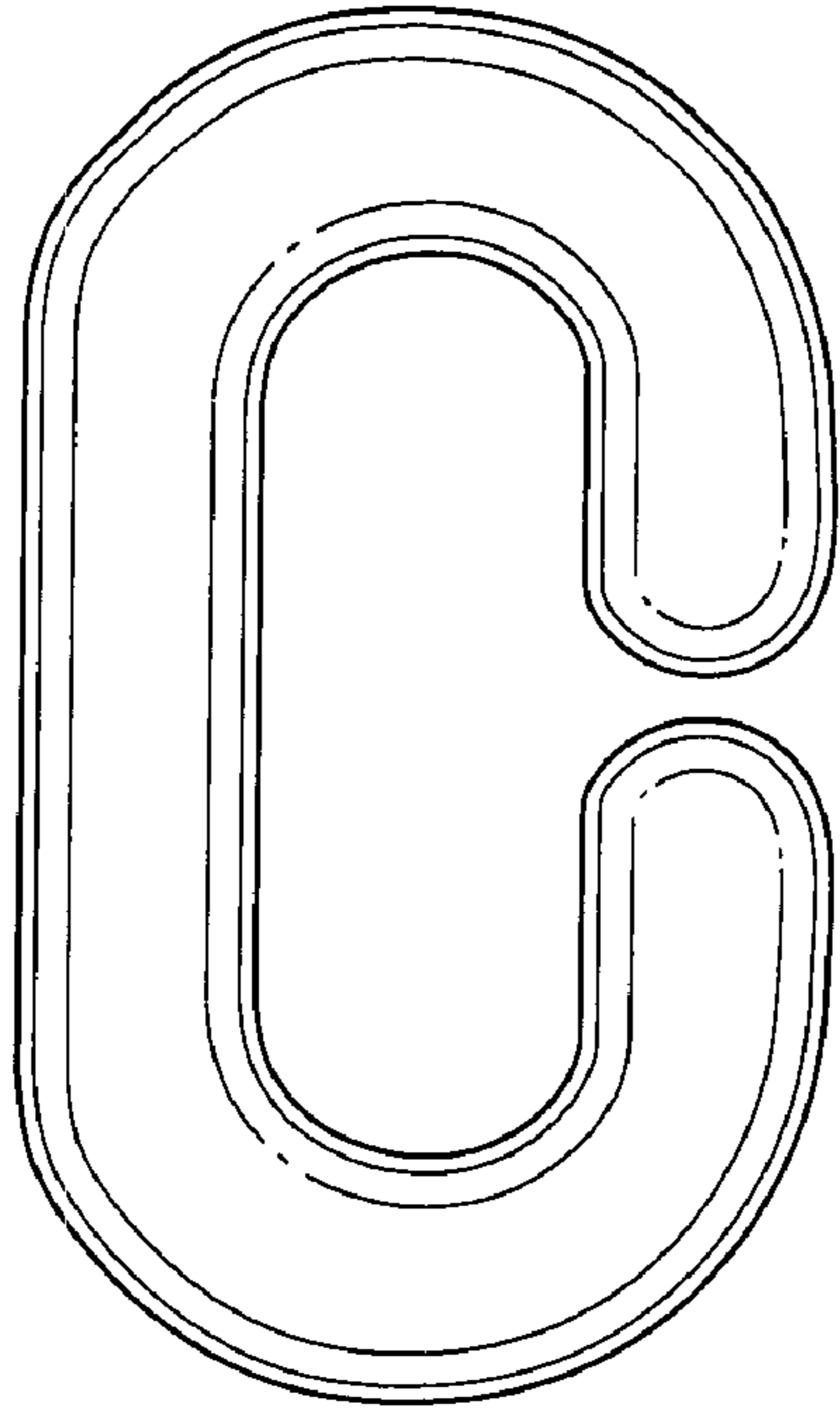

FIG. 63



FIG. 64



FIG. 65

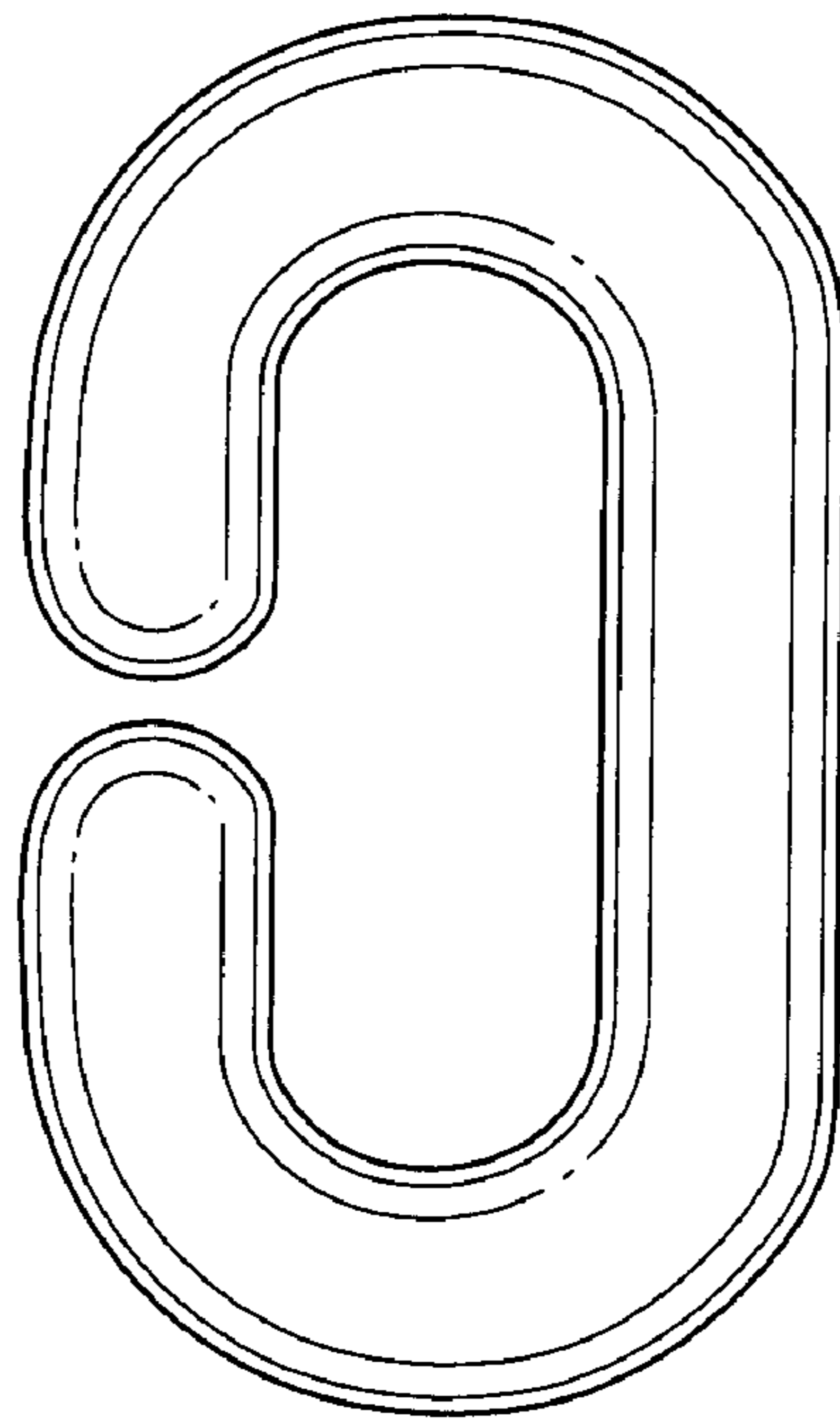

FIG. 66

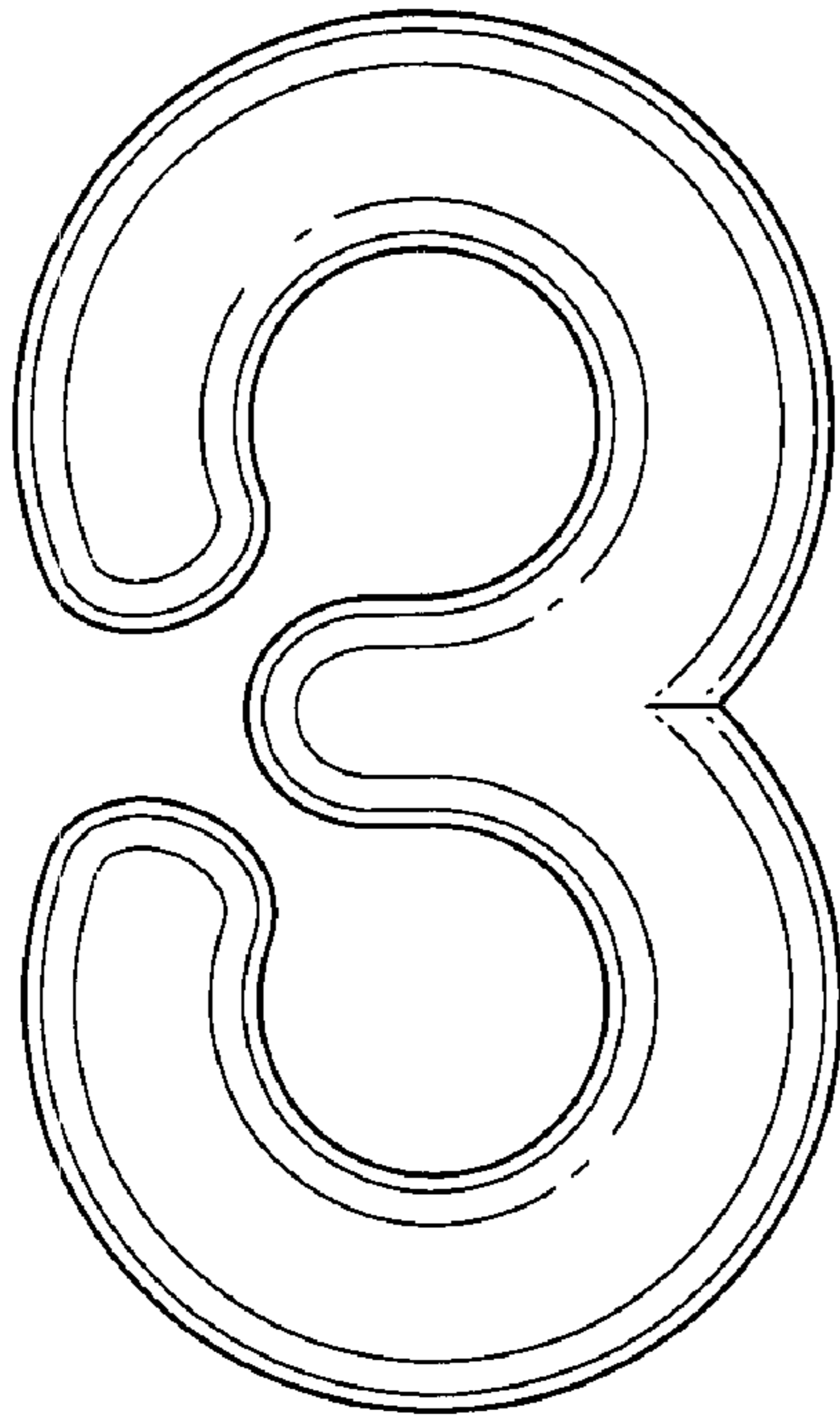

FIG. 67

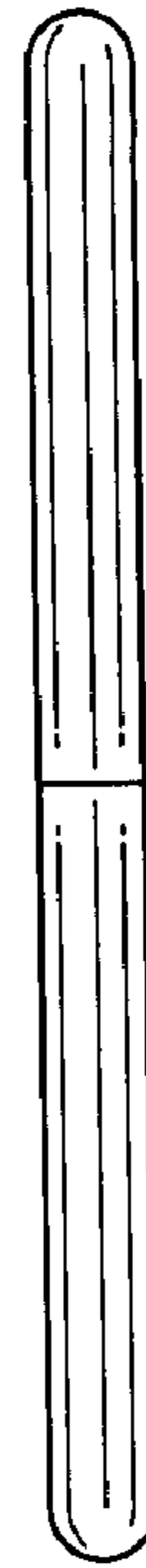

FIG. 68

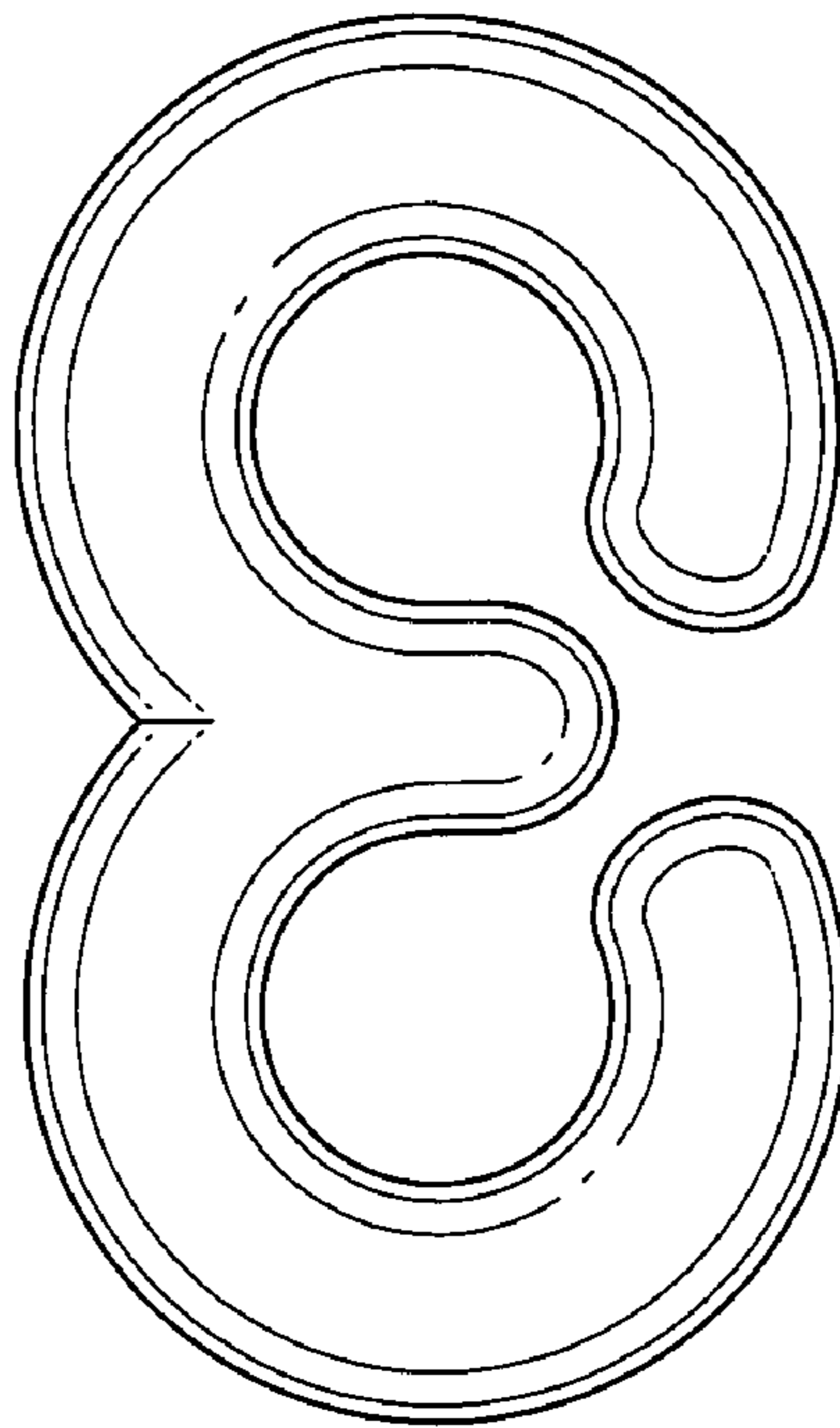

FIG. 69

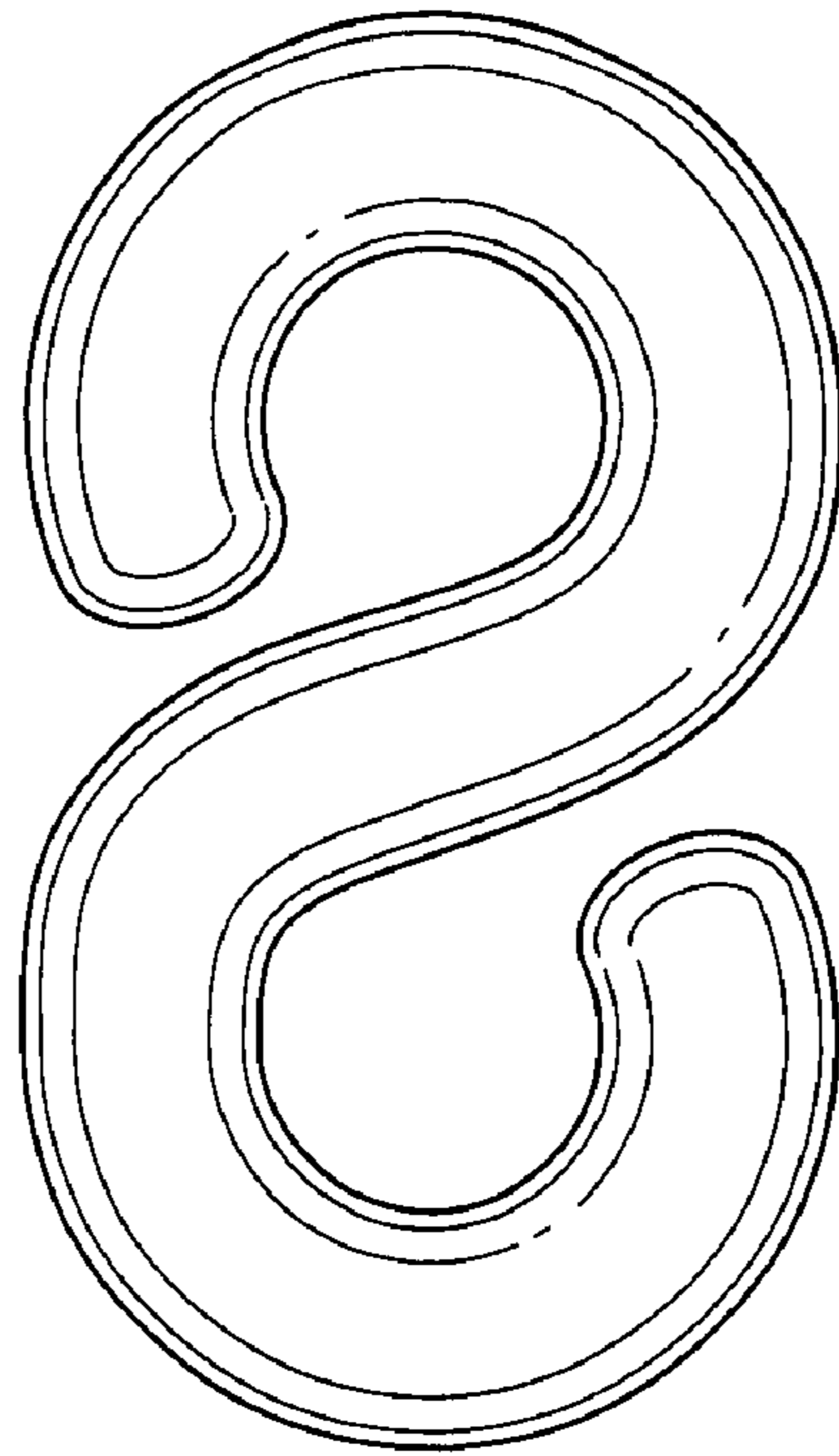

FIG. 70



FIG. 71



FIG. 72

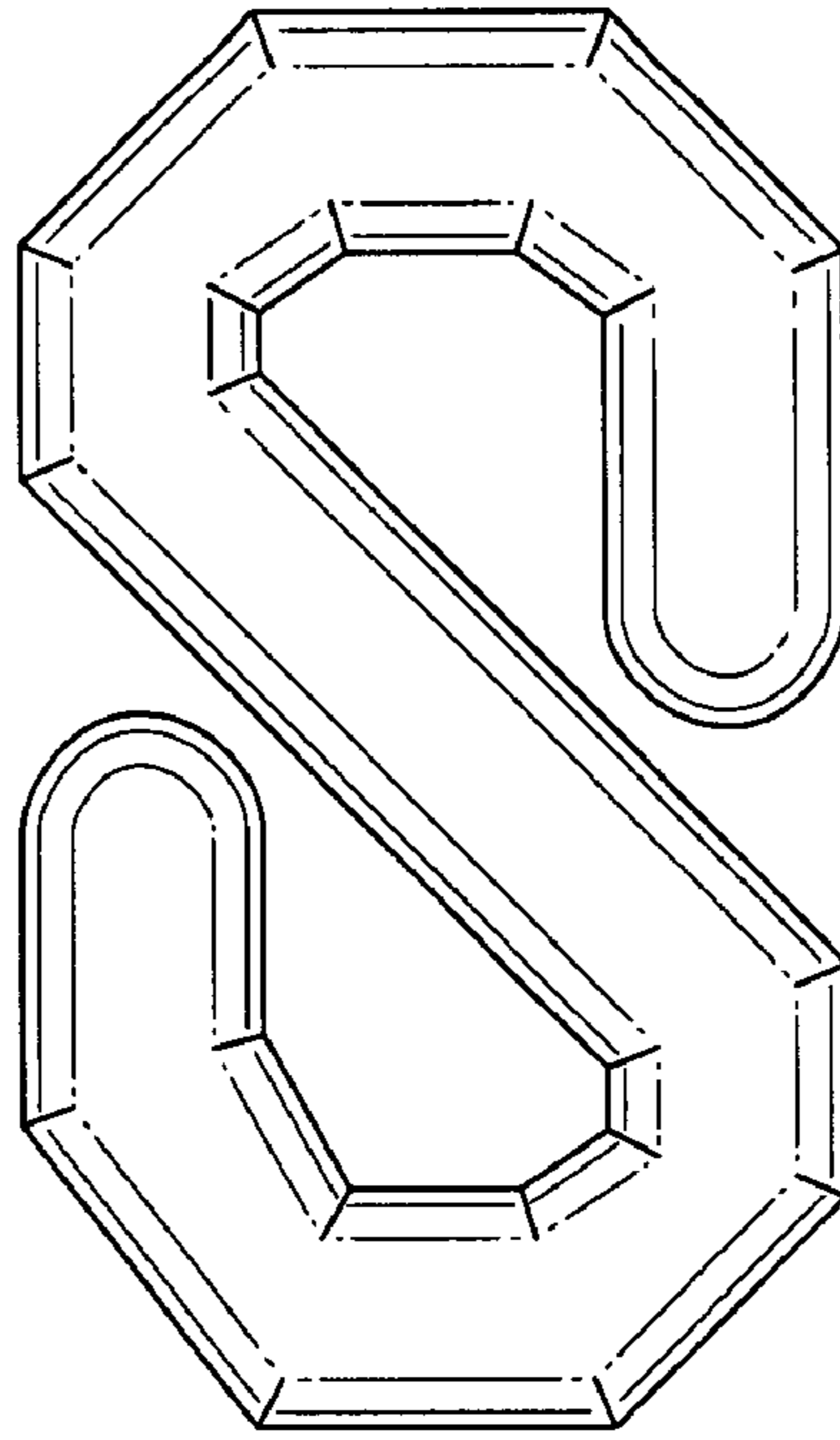

FIG. 73



FIG. 74



FIG. 75

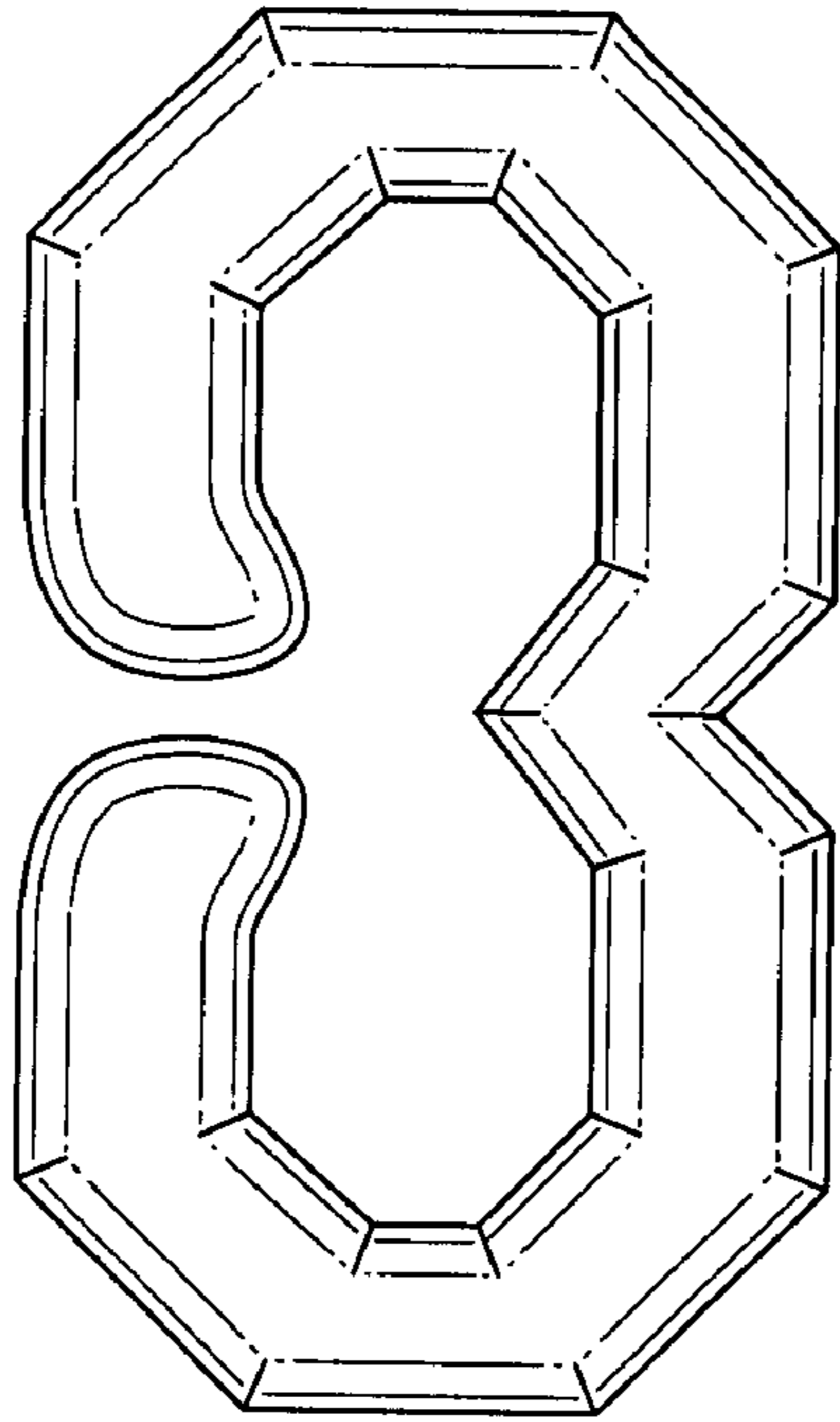

FIG. 76



FIG. 77

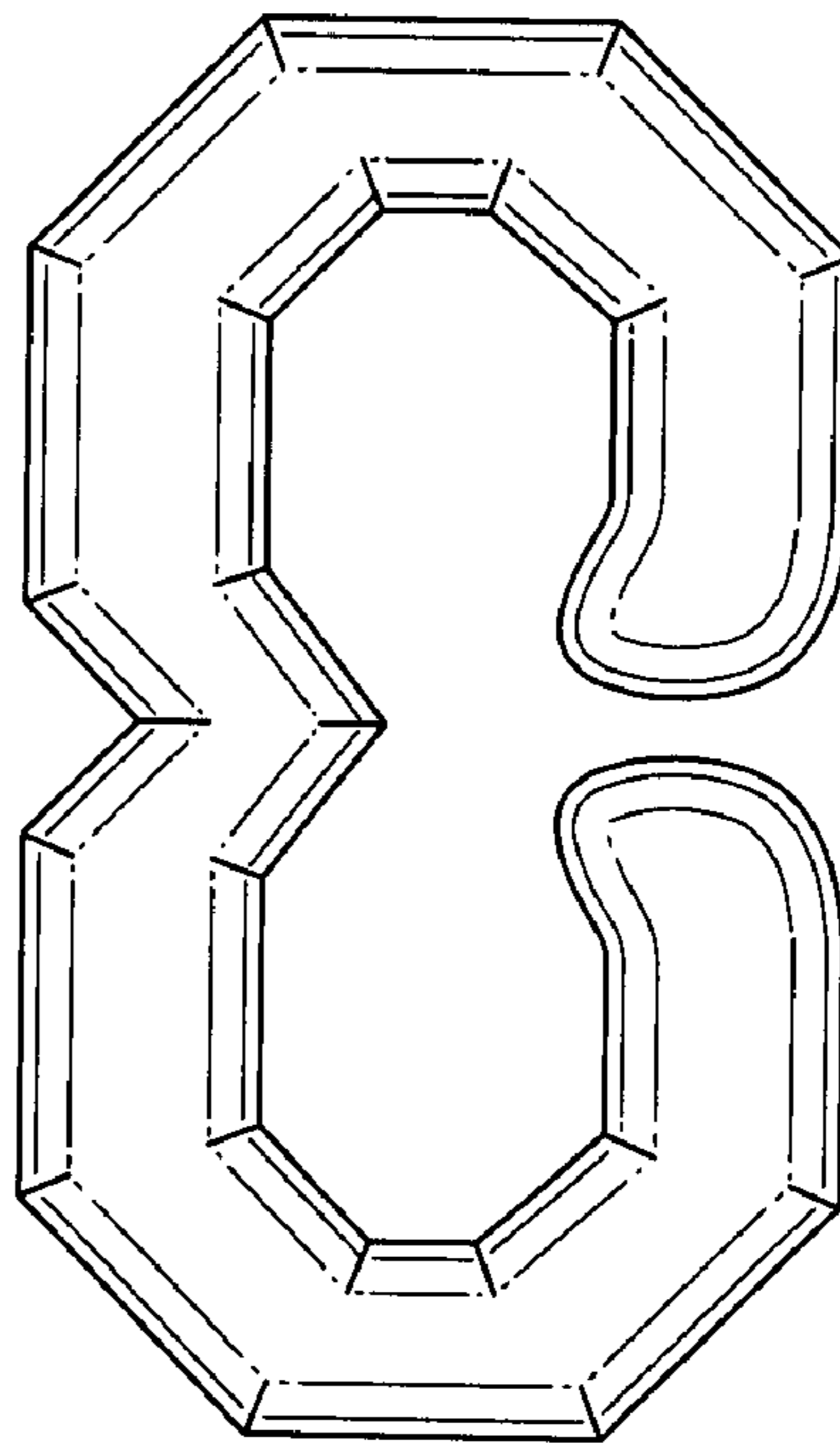

FIG. 78

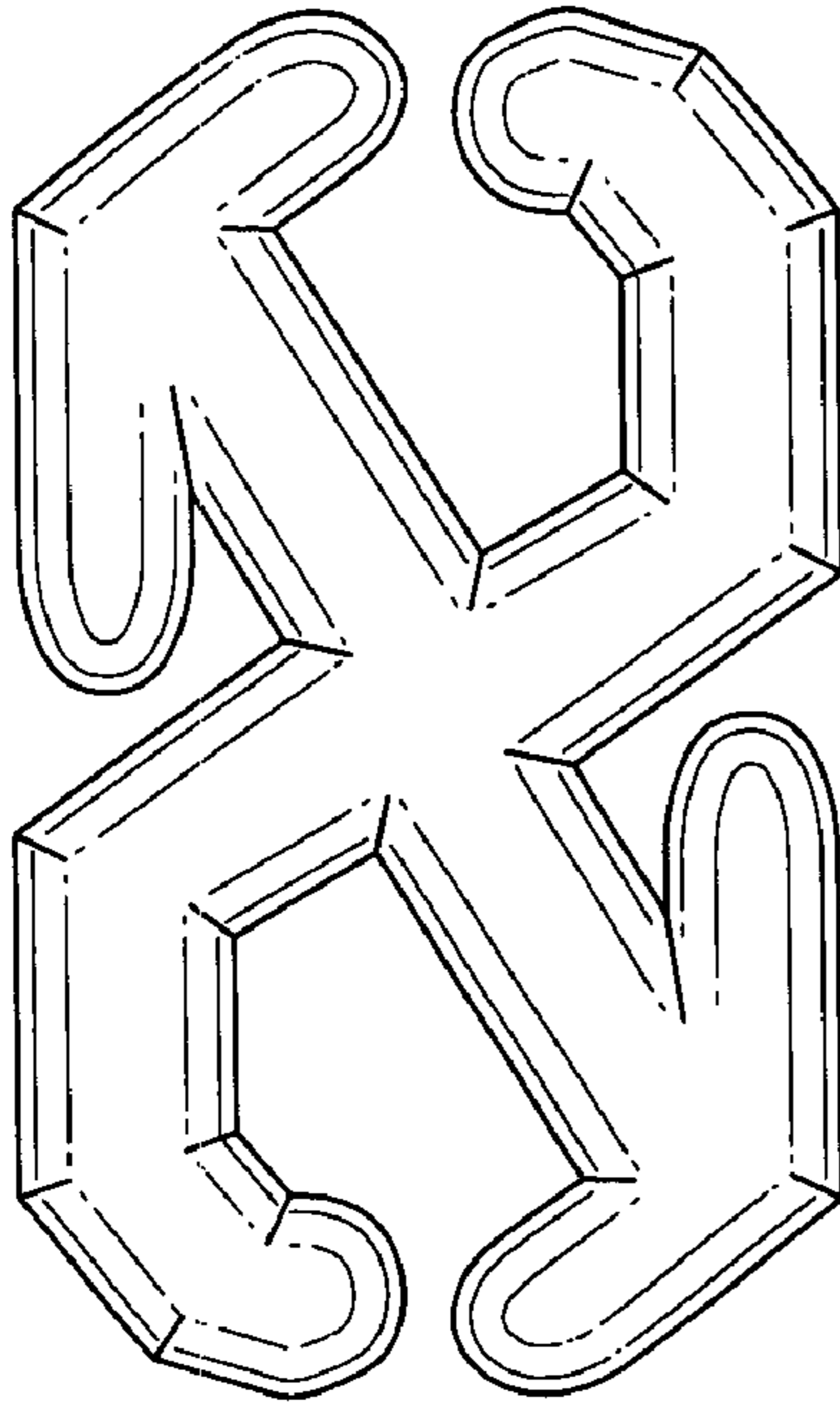

FIG. 79



FIG. 80



FIG. 81



FIG. 82



FIG. 83

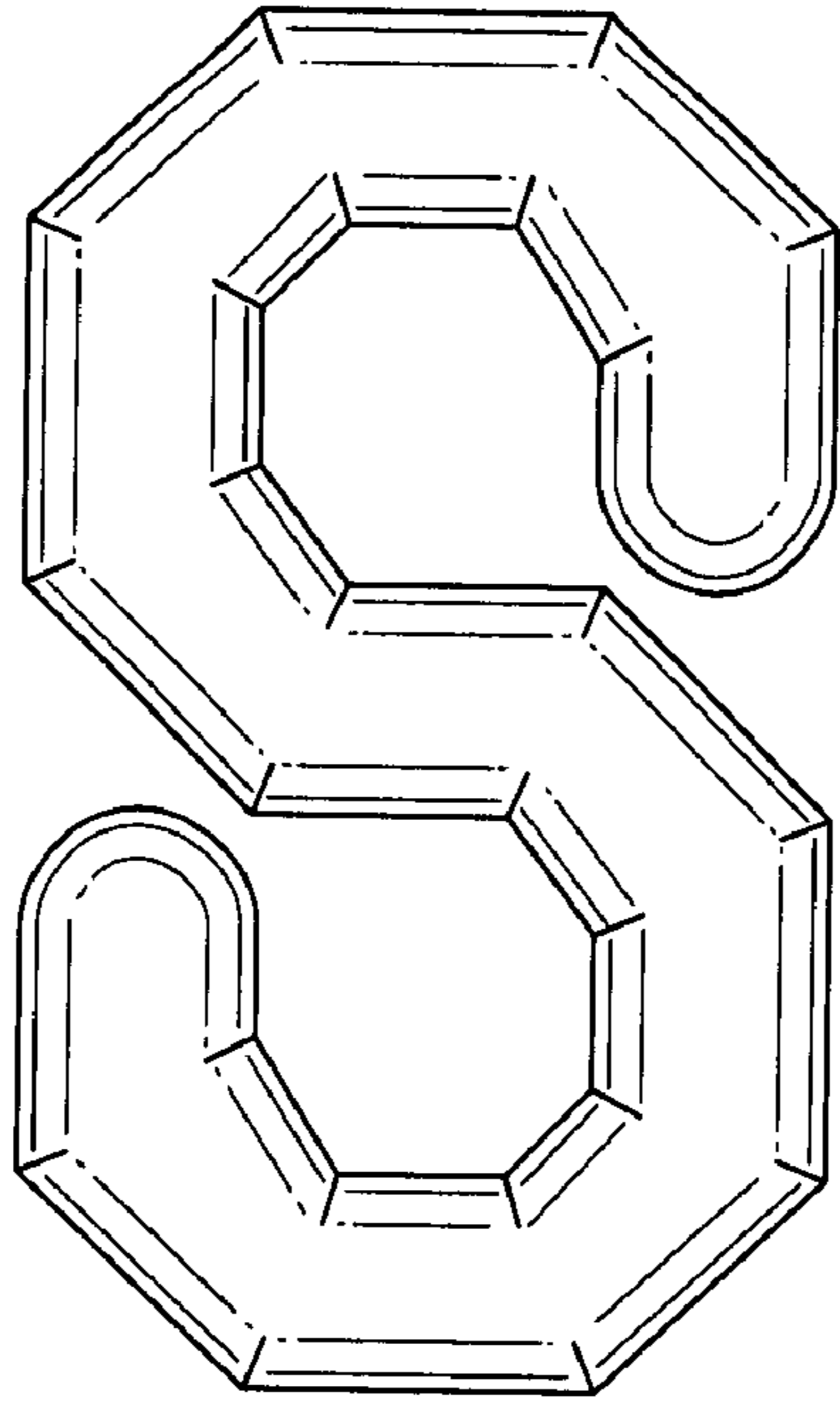

FIG. 84

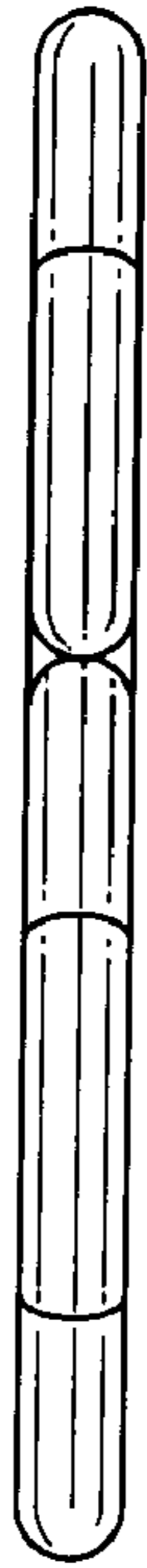

FIG. 85

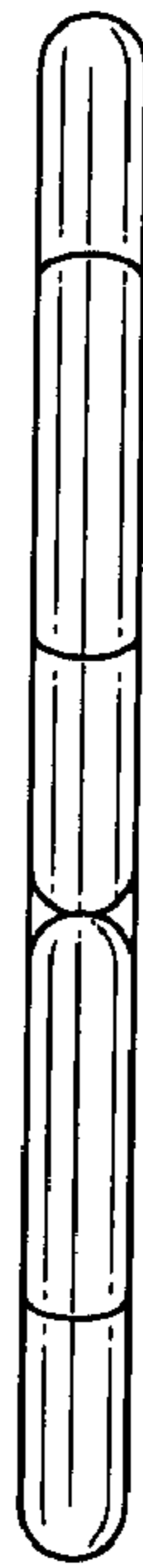

FIG. 86

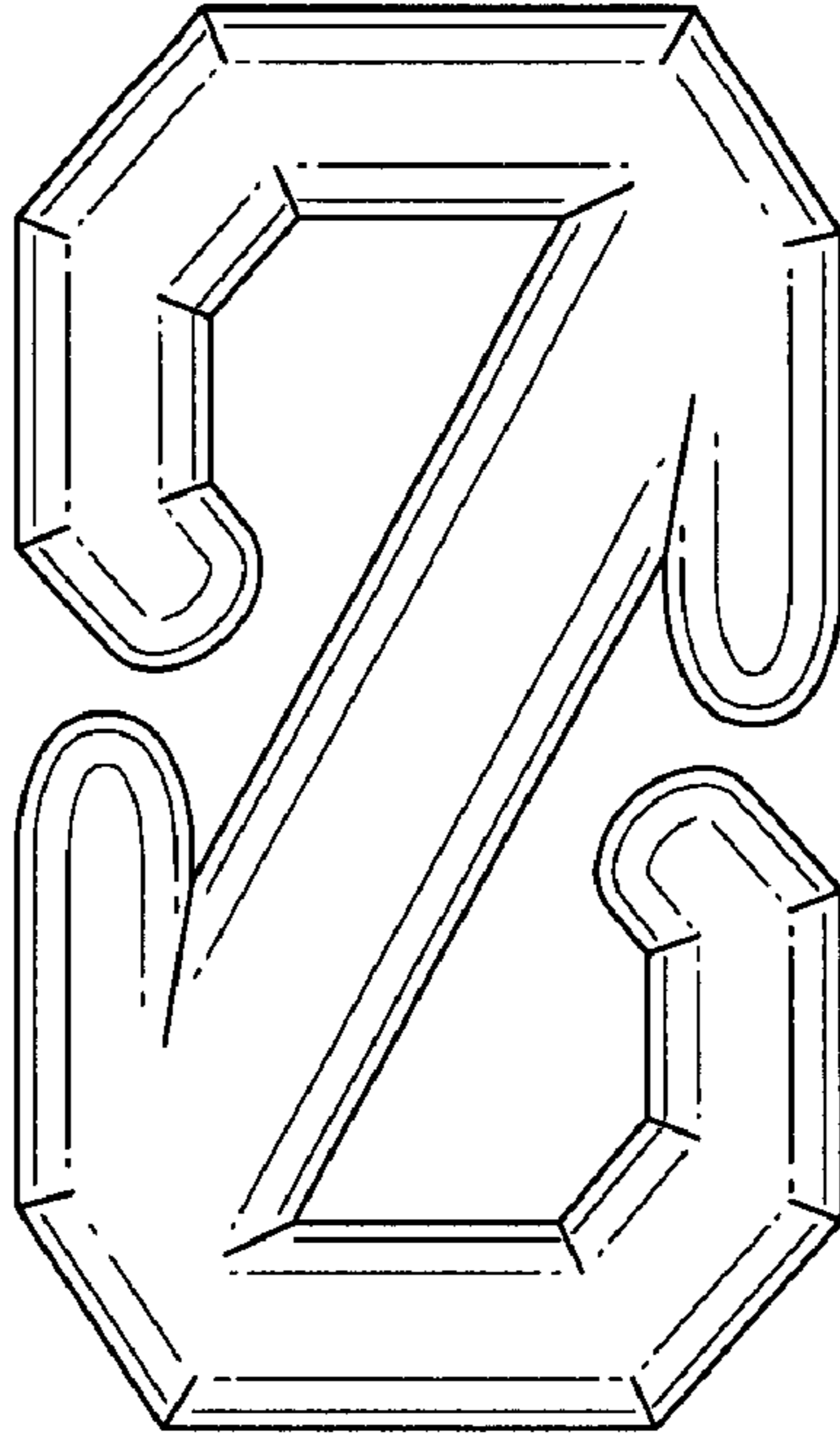

FIG. 87



FIG. 88



FIG. 89

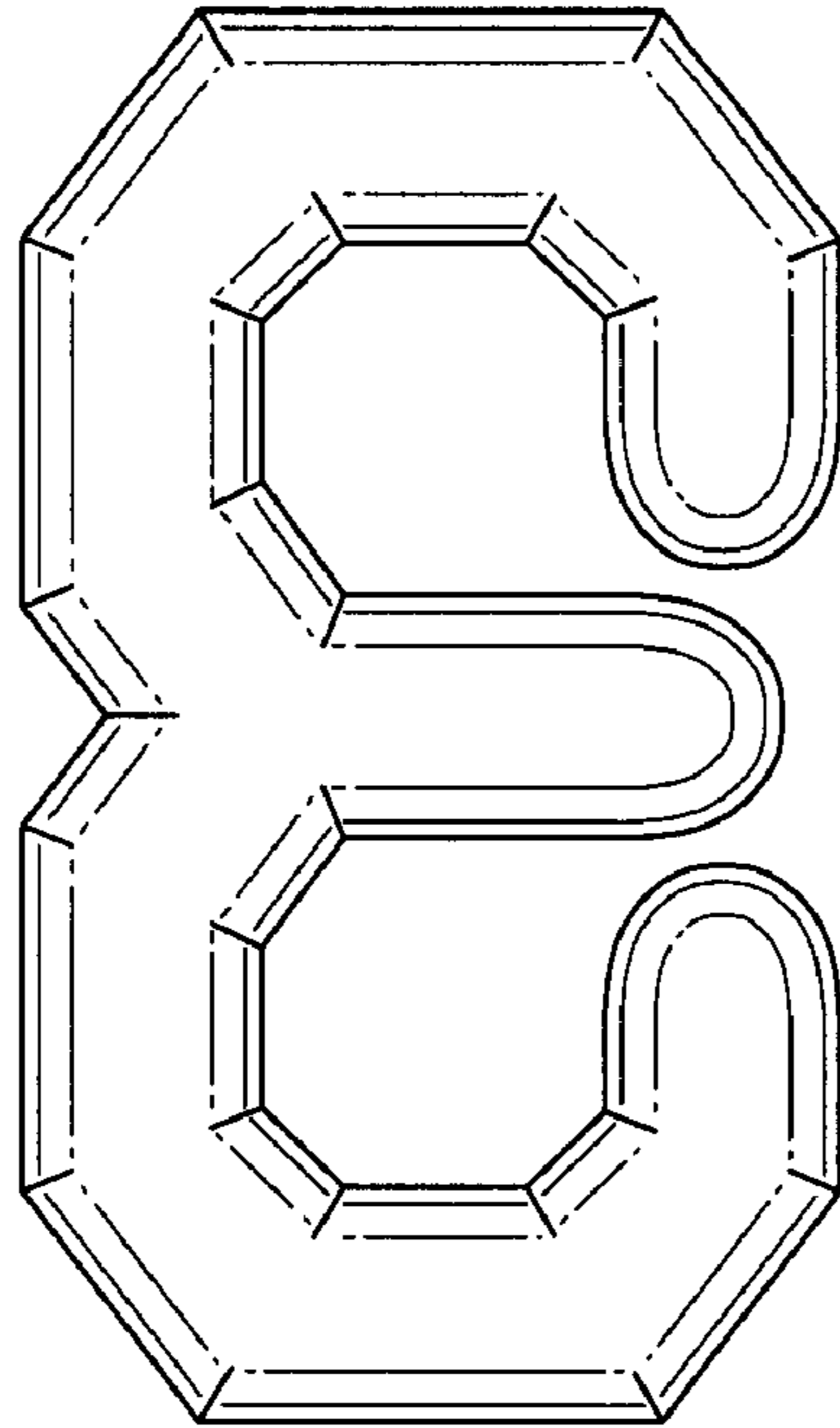

FIG. 90



FIG. 91

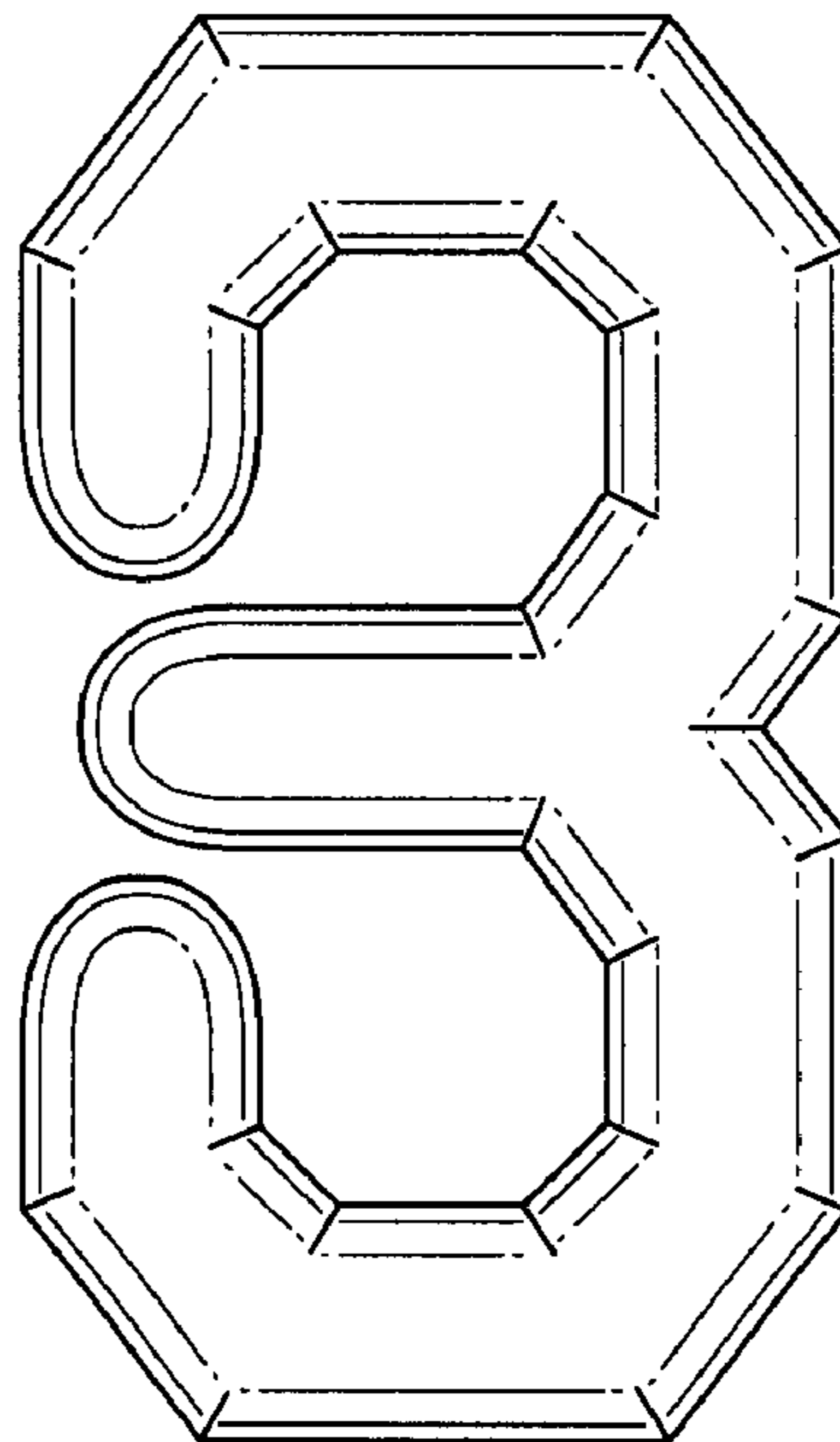

FIG. 92

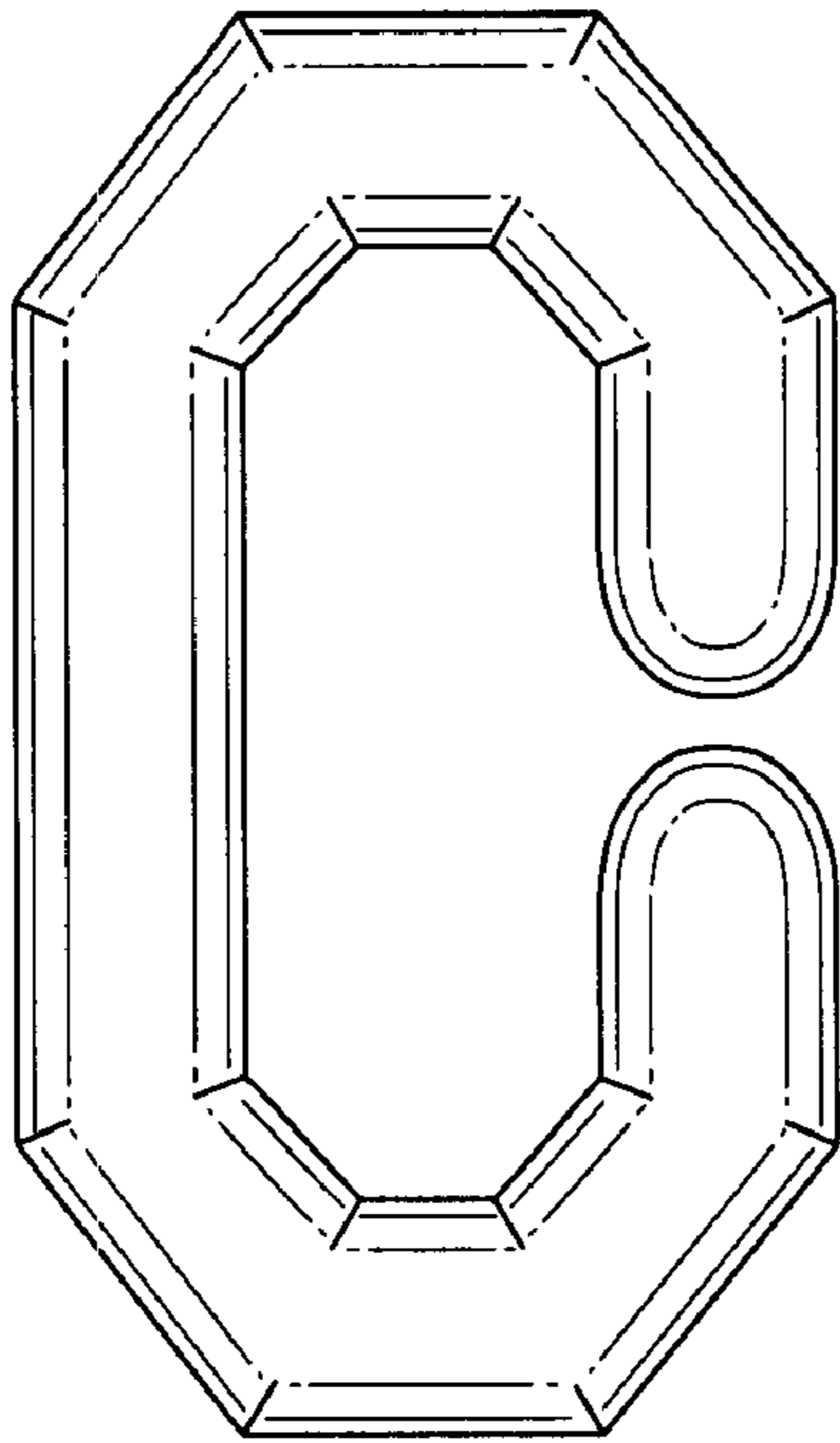

FIG. 93



FIG. 94



FIG. 95

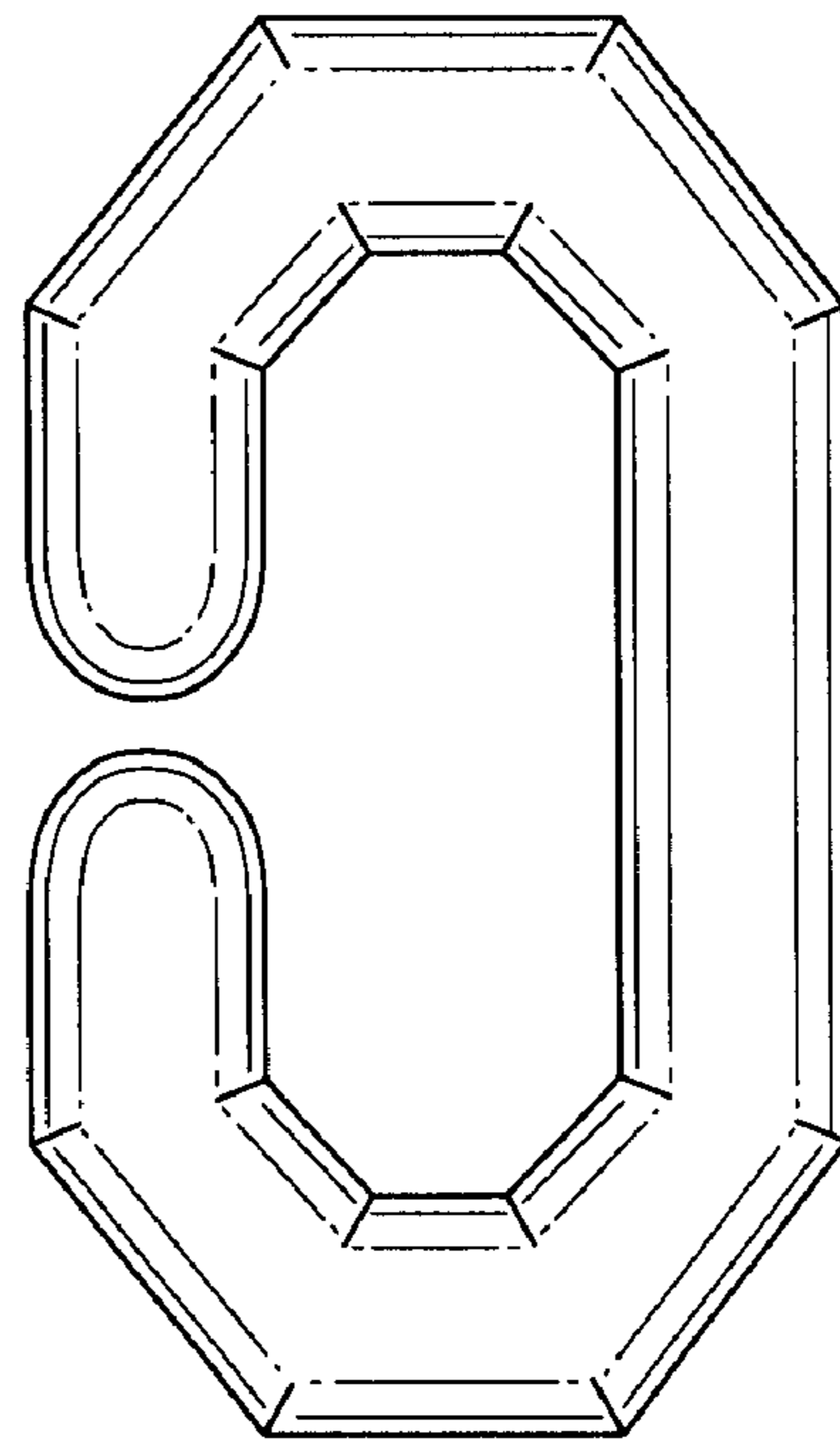

FIG. 96

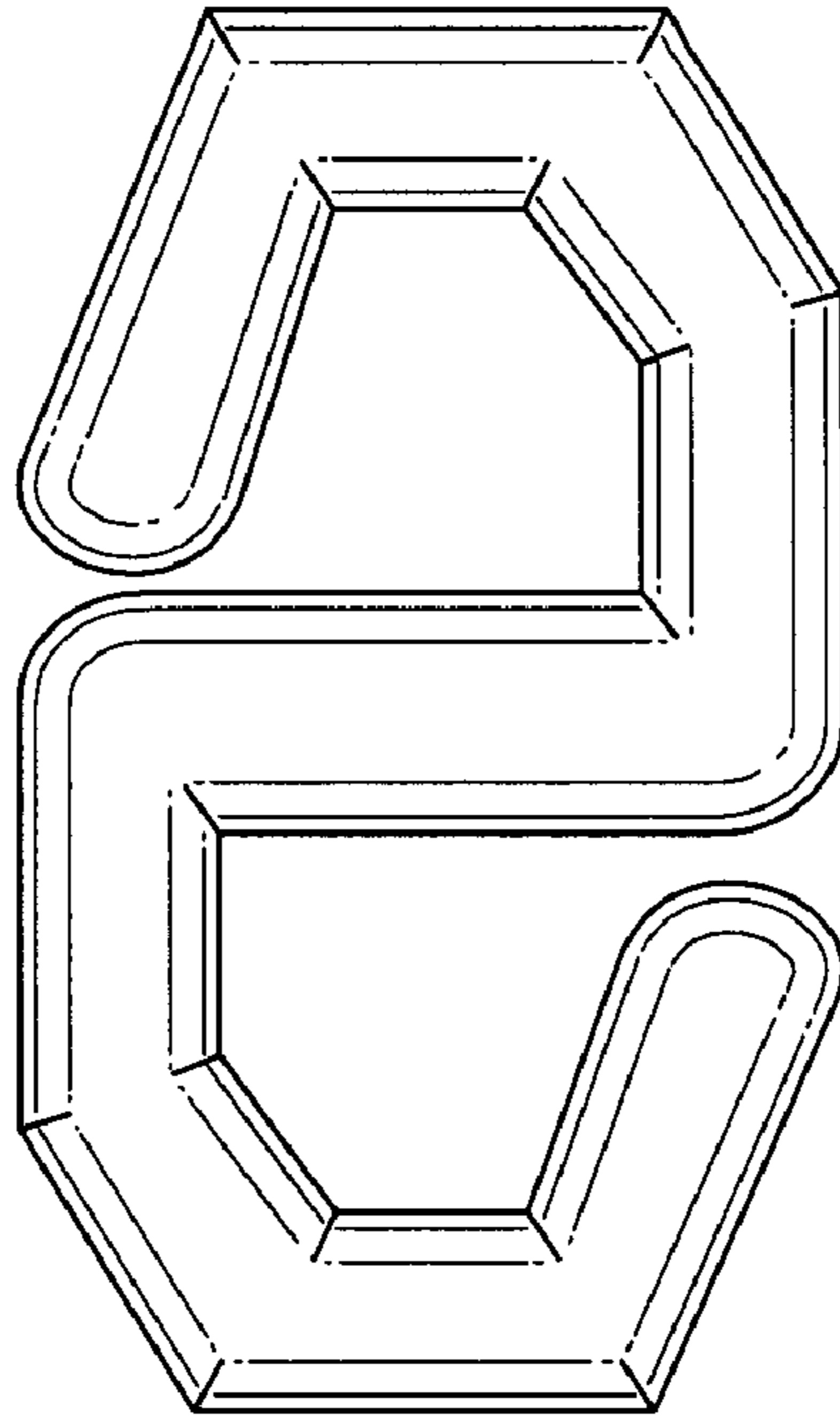

FIG. 97



FIG. 98

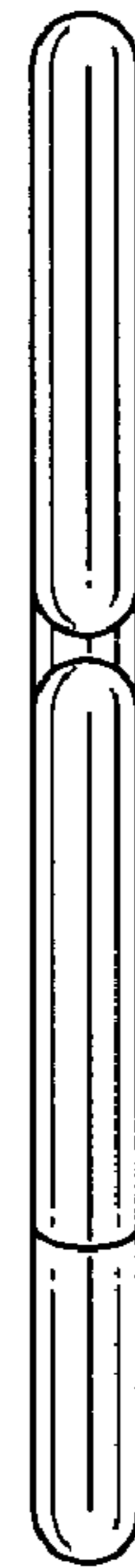

FIG. 99

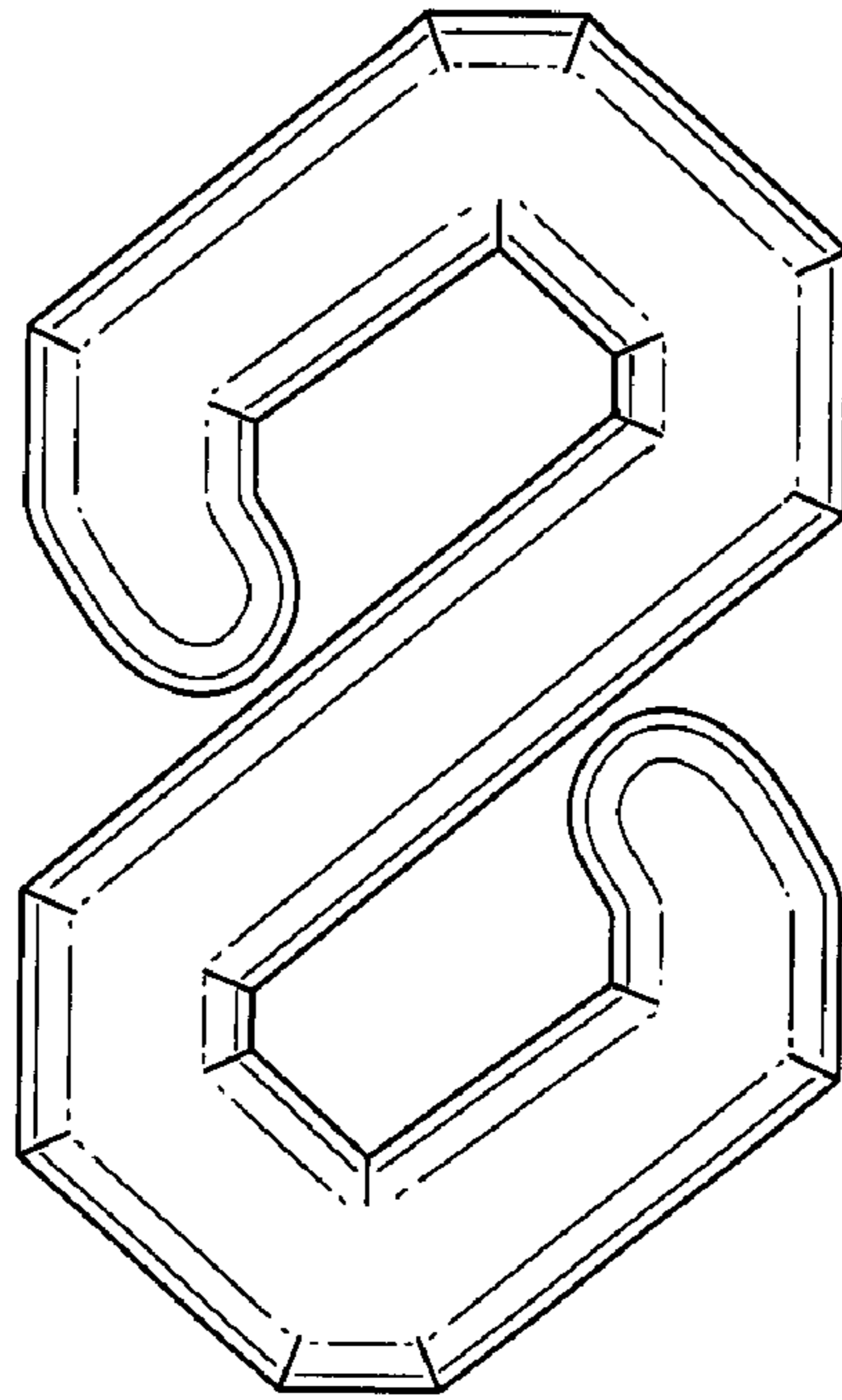

FIG. 100



FIG. 101



FIG. 102

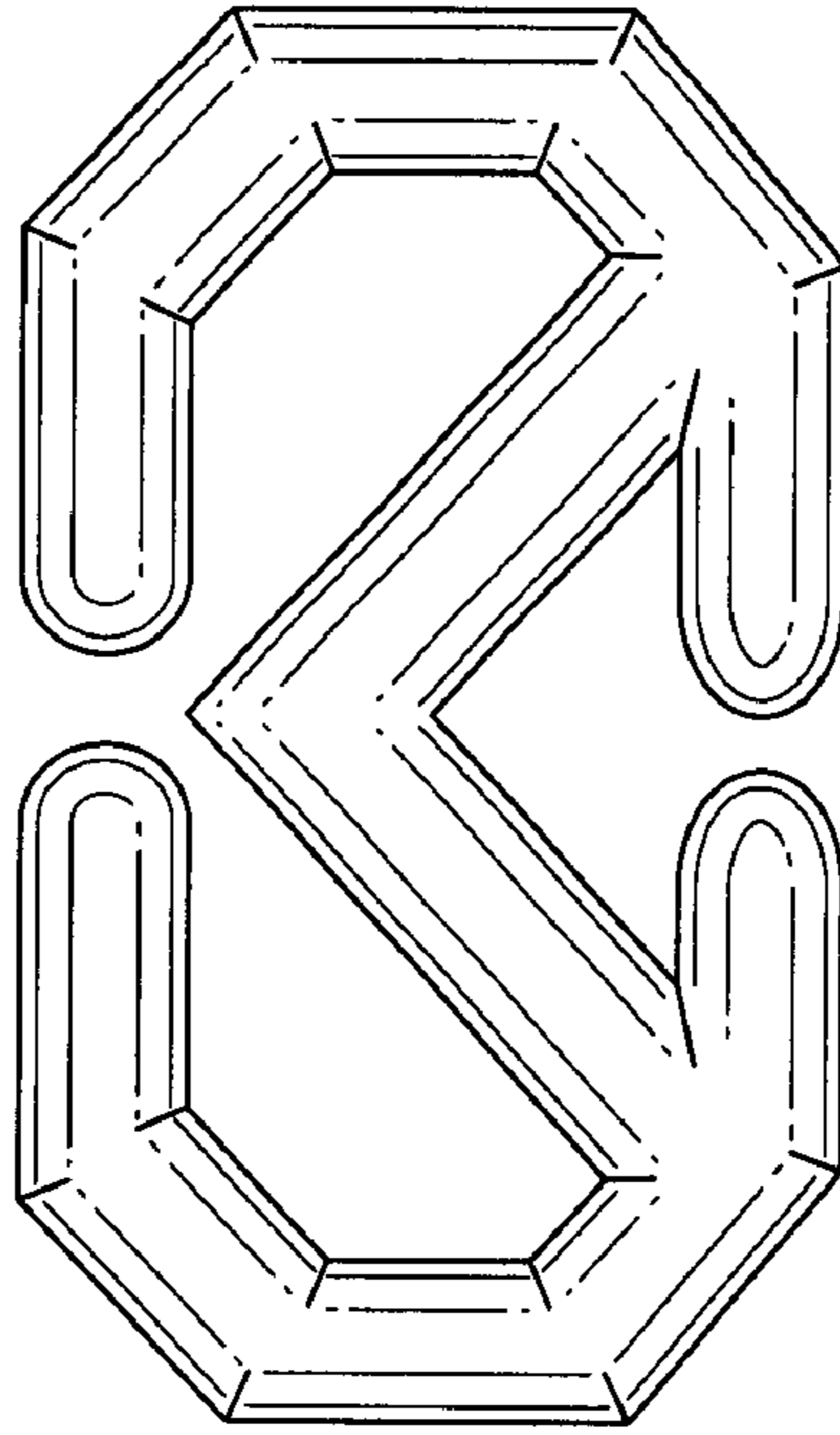

FIG. 103



FIG. 104



FIG. 105