

US00D541345S

(12) **United States Design Patent** (10) **Patent No.:** **US D541,345 S**  
**Chang et al.** (45) **Date of Patent:** **\*\* Apr. 24, 2007**

(54) **SET OF FRACTION CARDS**

(57) **CLAIM**

(75) Inventors: **Hai-Chau Chang**, Taipei (TW);  
**Ho-Chia Chueh**, No. 1, Sec. 4,  
Roosevelt Rd., Taipei (TW)

The ornamental design for a set of fraction cards, as shown and described.

(73) Assignee: **Ho-Chia Chueh**, Taipei (TW)

**DESCRIPTION**

(\*\*) Term: **14 Years**

FIG. 1 is a top view of a card of a set of fraction cards, showing our new design;

(21) Appl. No.: **29/265,682**

FIG. 2 is another card thereof;

(22) Filed: **Sep. 7, 2006**

FIG. 3 is another card thereof;

(51) **LOC (8) Cl.** ..... **19-07**

FIG. 4 is another card thereof;

(52) **U.S. Cl.** ..... **D19/62**

FIG. 5 is another card thereof;

(58) **Field of Classification Search** ..... D19/59-64;  
D10/71; 273/292, 297, 299, 301-302, 304-305;  
434/188-189, 191, 195-196, 205, 208-209,  
434/214

FIG. 6 is another card thereof;

See application file for complete search history.

FIG. 7 is another card thereof;

(56) **References Cited**

**U.S. PATENT DOCUMENTS**

1,275,869	A	*	8/1918	Deal	.....	273/301
D163,085	S	*	5/1951	Bishop	.....	434/205
D168,834	S	*	2/1953	Farinacci	.....	D19/62
D173,363	S	*	11/1954	Louis	.....	434/209
4,812,123	A	*	3/1989	House	.....	434/195
D302,566	S	*	8/1989	Wolf	.....	D19/59
5,192,077	A	*	3/1993	Caicedo	.....	434/196
5,470,234	A	*	11/1995	Sher	.....	434/214
D376,326	S	*	12/1996	Wilson	.....	D10/71
5,823,783	A	*	10/1998	Adams	.....	434/208
7,052,279	B1	*	5/2006	Losq	.....	434/191
2006/0157932	A1	*	7/2006	Latell	.....	273/292

FIG. 8 is another card thereof;

FIG. 9 is another card thereof;

FIG. 10 is another card thereof;

FIG. 11 is another card thereof;

FIG. 12 is another card thereof;

FIG. 13 is another card thereof;

FIG. 14 is another card thereof;

FIG. 15 is another card thereof;

FIG. 16 is another card thereof;

FIG. 17 is another card thereof;

FIG. 18 is another card thereof;

FIG. 19 is another card thereof;

FIG. 20 is another card thereof;

FIG. 21 is another card thereof;

FIG. 22 is another card thereof;

FIG. 23 is another card thereof;

FIG. 24 is another card thereof;

FIG. 25 is another card thereof;

FIG. 26 is another card thereof;

FIG. 27 is another card thereof;

FIG. 28 is another card thereof;

FIG. 29 is another card thereof;

FIG. 30 is another card thereof;

FIG. 31 is another card thereof;

FIG. 32 is another card thereof;

FIG. 33 is another card thereof;

FIG. 34 is another card thereof;

FIG. 35 is another card thereof;

FIG. 36 is another card thereof;

FIG. 37 is another card thereof;

\* cited by examiner

*Primary Examiner*—Louis Zarfes

*Assistant Examiner*—Mark Cavanna

(74) *Attorney, Agent, or Firm*—Bacon & Thomas PLLC

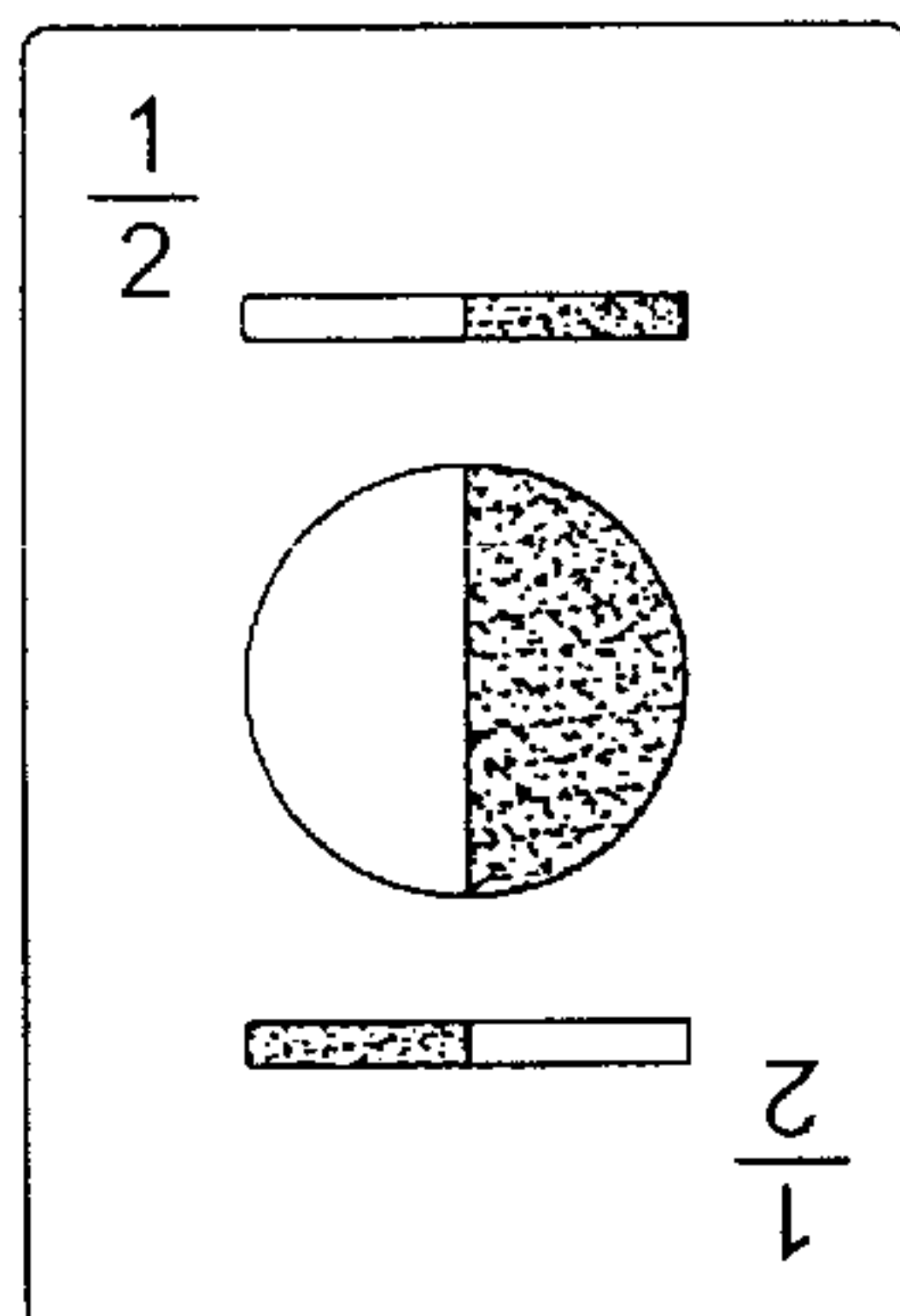

FIG. 38 is another card thereof;  
FIG. 39 is another card thereof;  
FIG. 40 is another card thereof;  
FIG. 41 is another card thereof;  
FIG. 42 is another card thereof;  
FIG. 43 is another card thereof;  
FIG. 44 is another card thereof;  
FIG. 45 is another card thereof;  
FIG. 46 is another card thereof;  
FIG. 47 is another card thereof;  
FIG. 48 is another card thereof;  
FIG. 49 is another card thereof;  
FIG. 50 is another card thereof;  
FIG. 51 is another card thereof;  
FIG. 52 is another card thereof;  
FIG. 53 is another card thereof;  
FIG. 54 is another card thereof;

FIG. 55 is another card thereof;  
FIG. 56 is another card thereof;  
FIG. 57 is another card thereof;  
FIG. 58 is another card thereof;  
FIG. 59 is another card thereof;  
FIG. 60 is another card thereof;  
FIG. 61 is another card thereof;  
FIG. 62 is another card thereof;  
FIG. 63 is another card thereof;  
FIG. 64 is another card thereof;  
FIG. 65 is another card thereof; and,  
FIG. 66 is another card thereof.

It being understood that the rear is flat and unornamented and the side is of no substantial thickness.

**1 Claim, 9 Drawing Sheets**

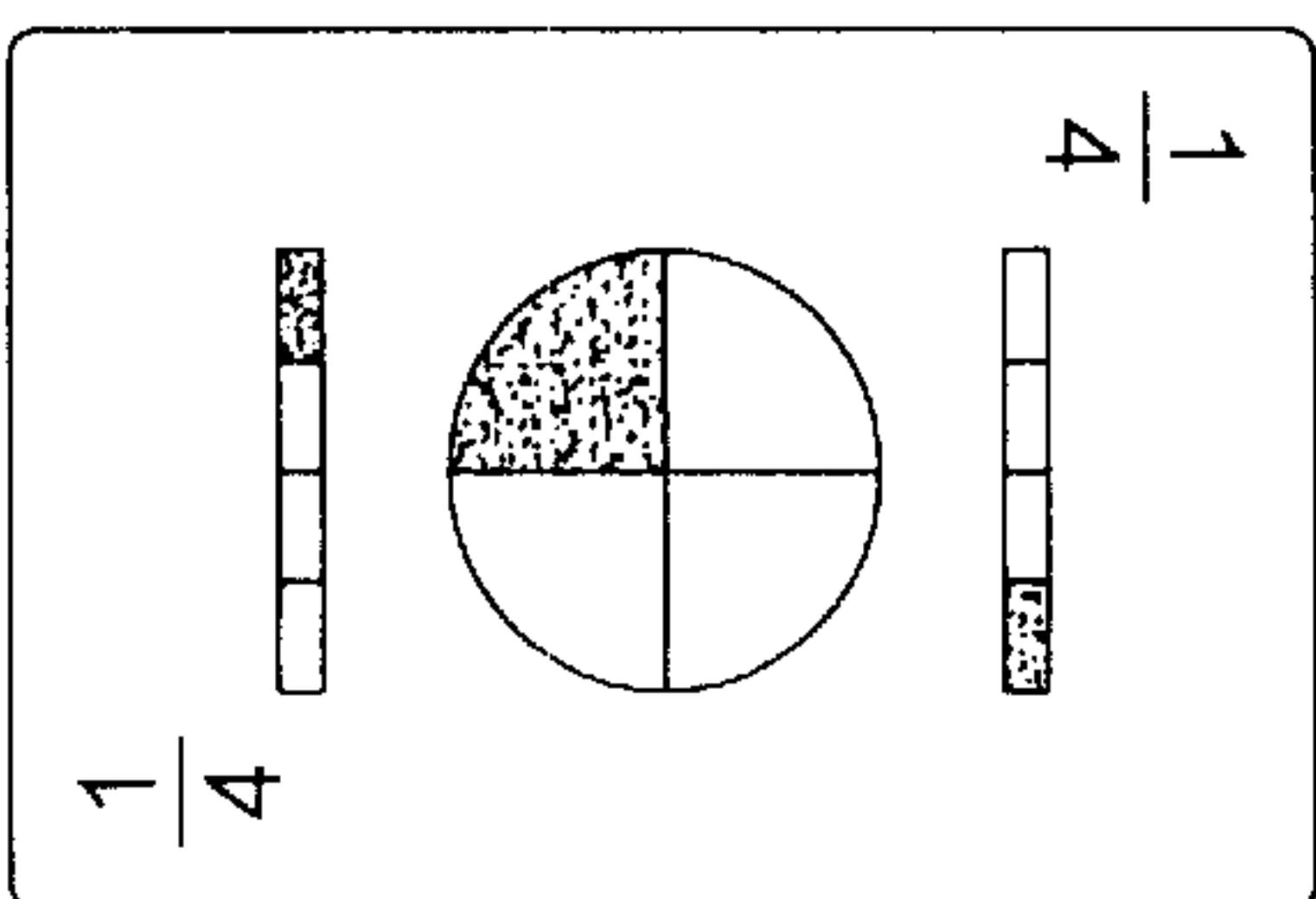

FIG. 1

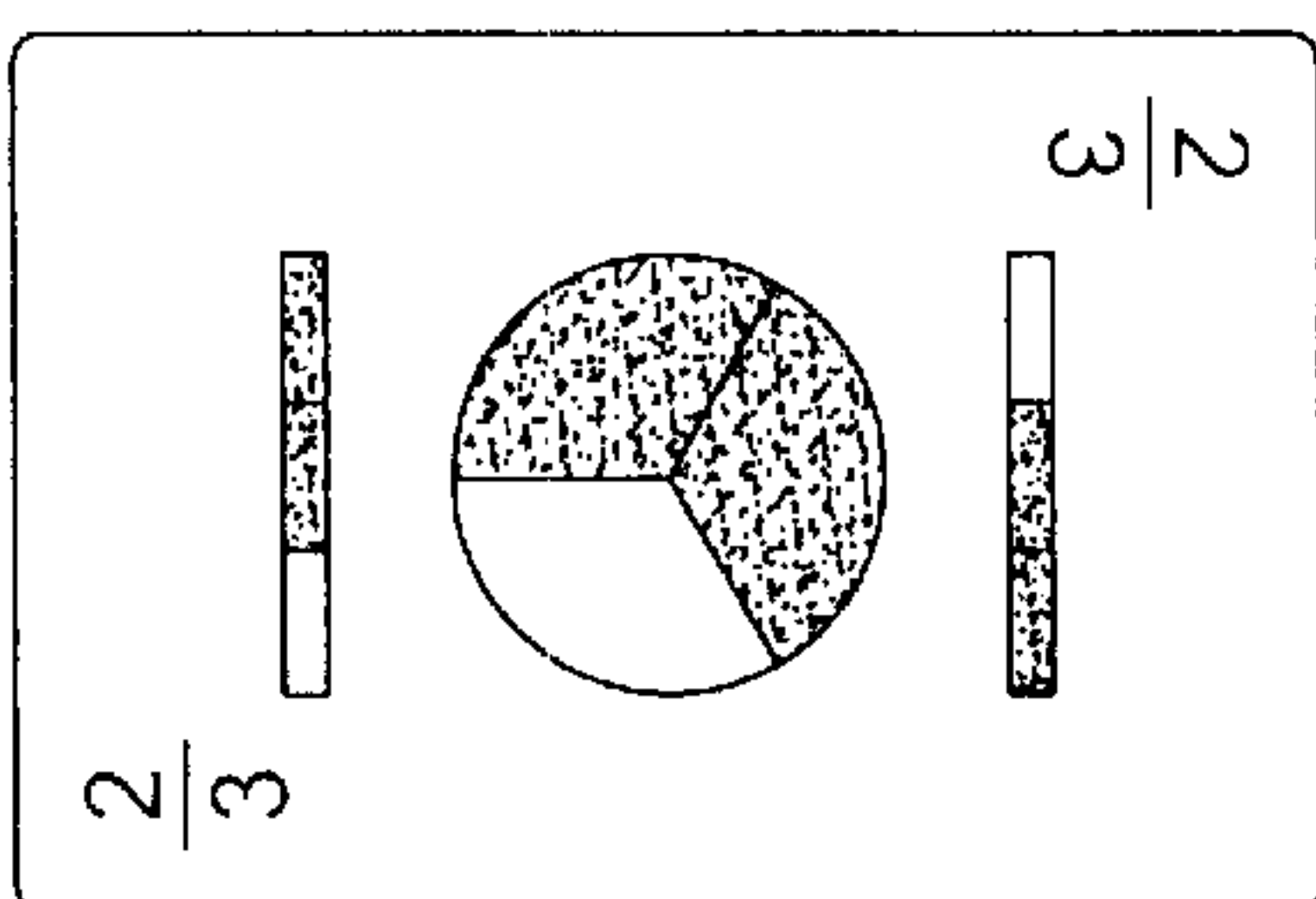

FIG. 2

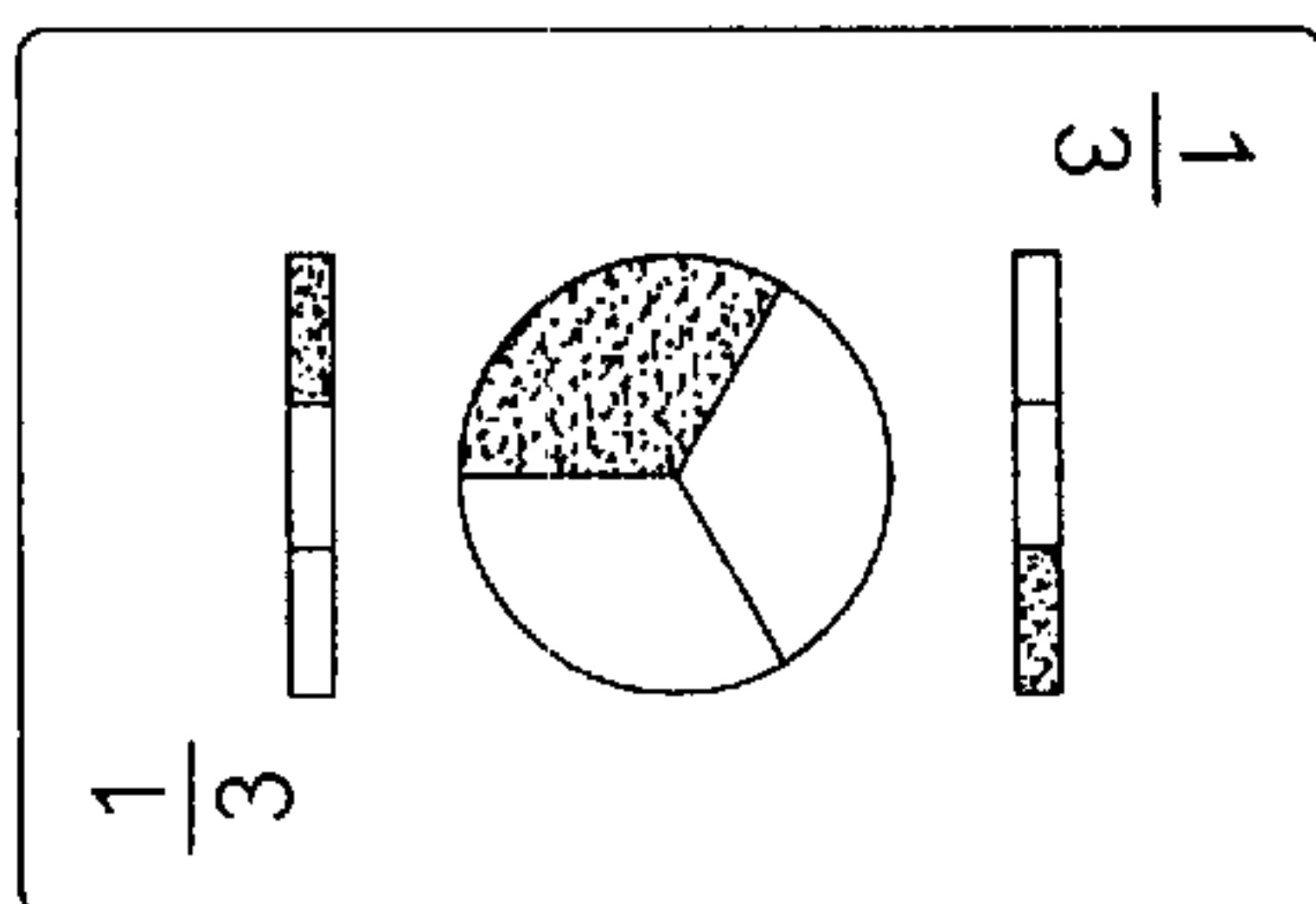

FIG. 3

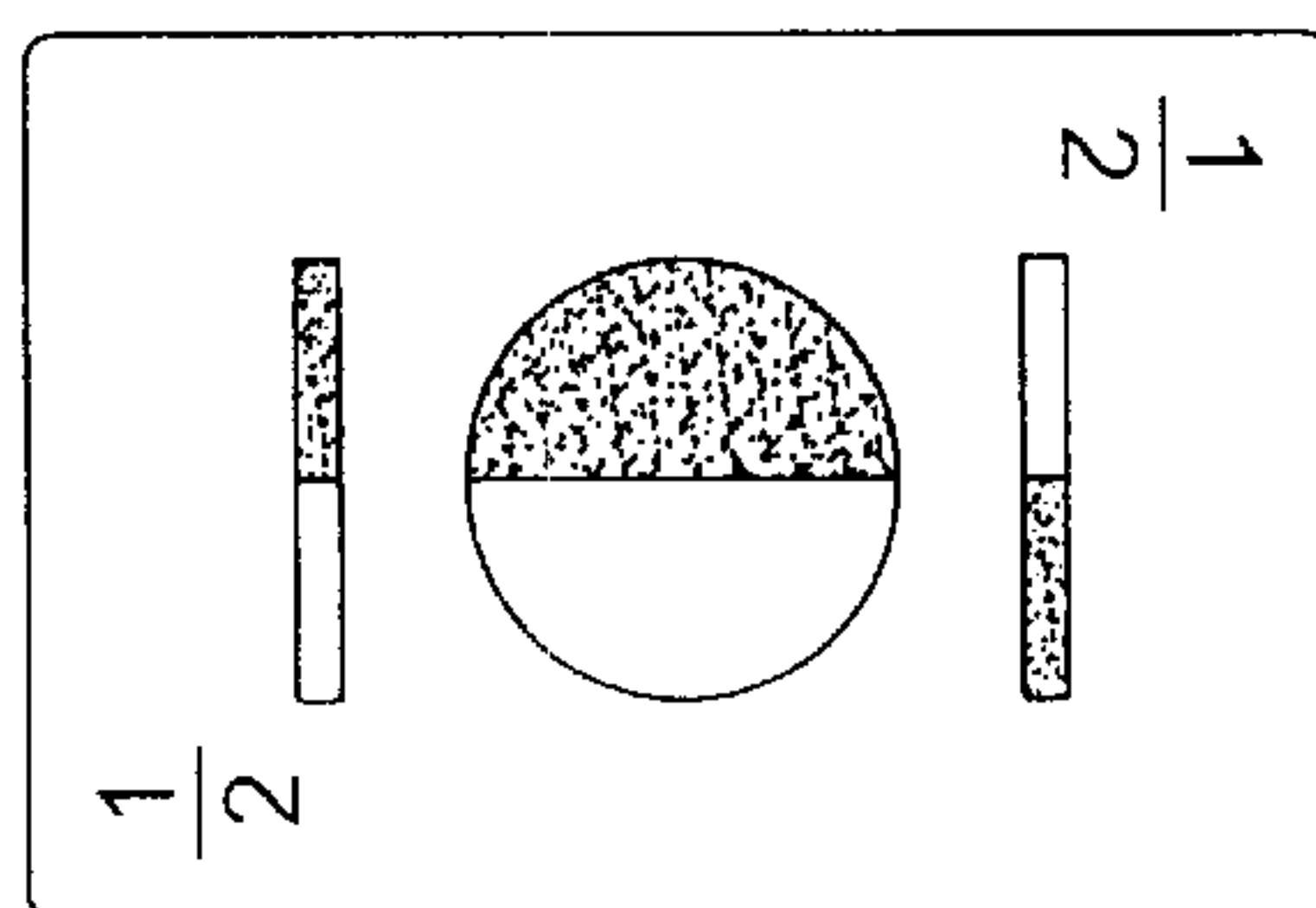

FIG. 4

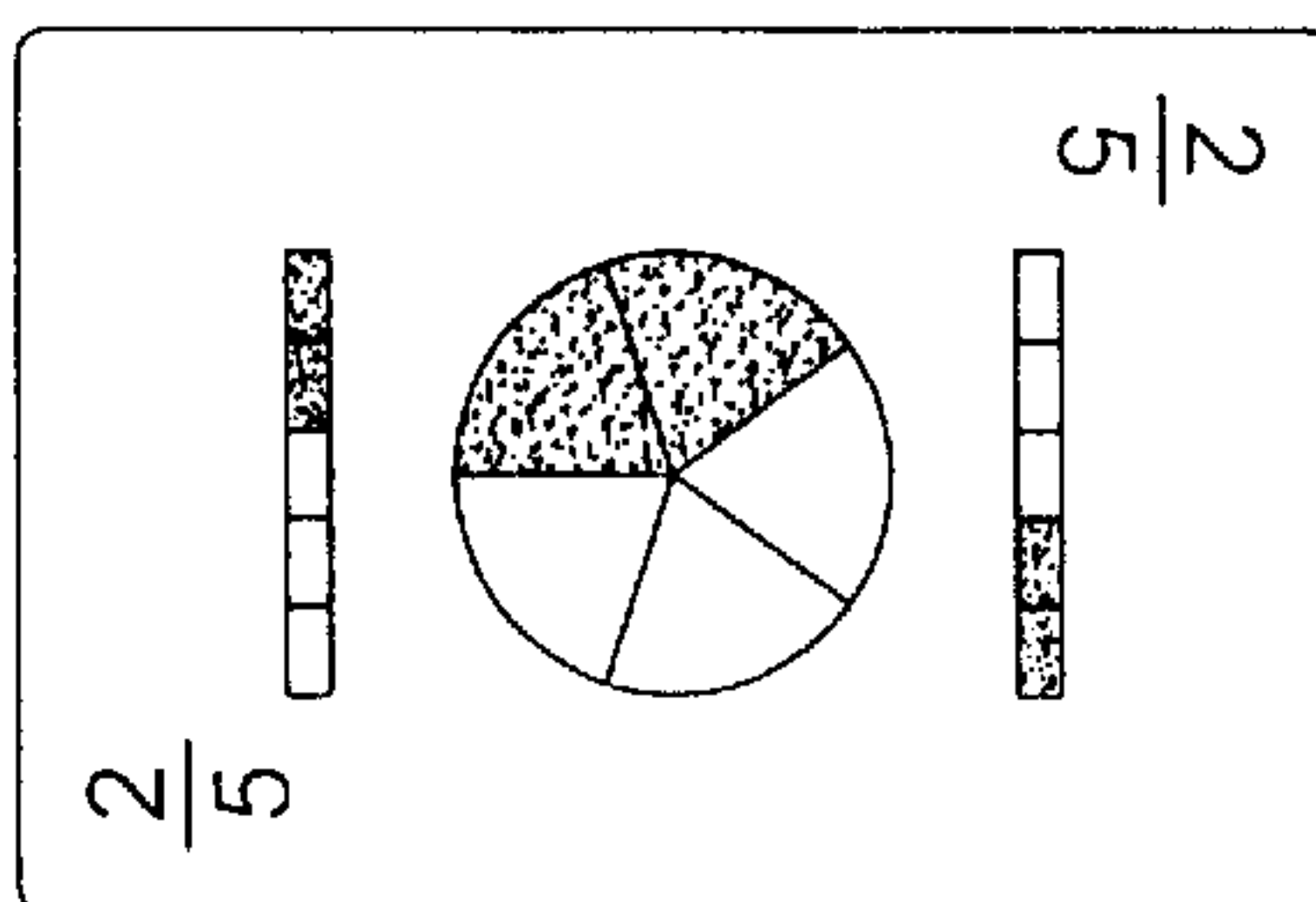

FIG. 5

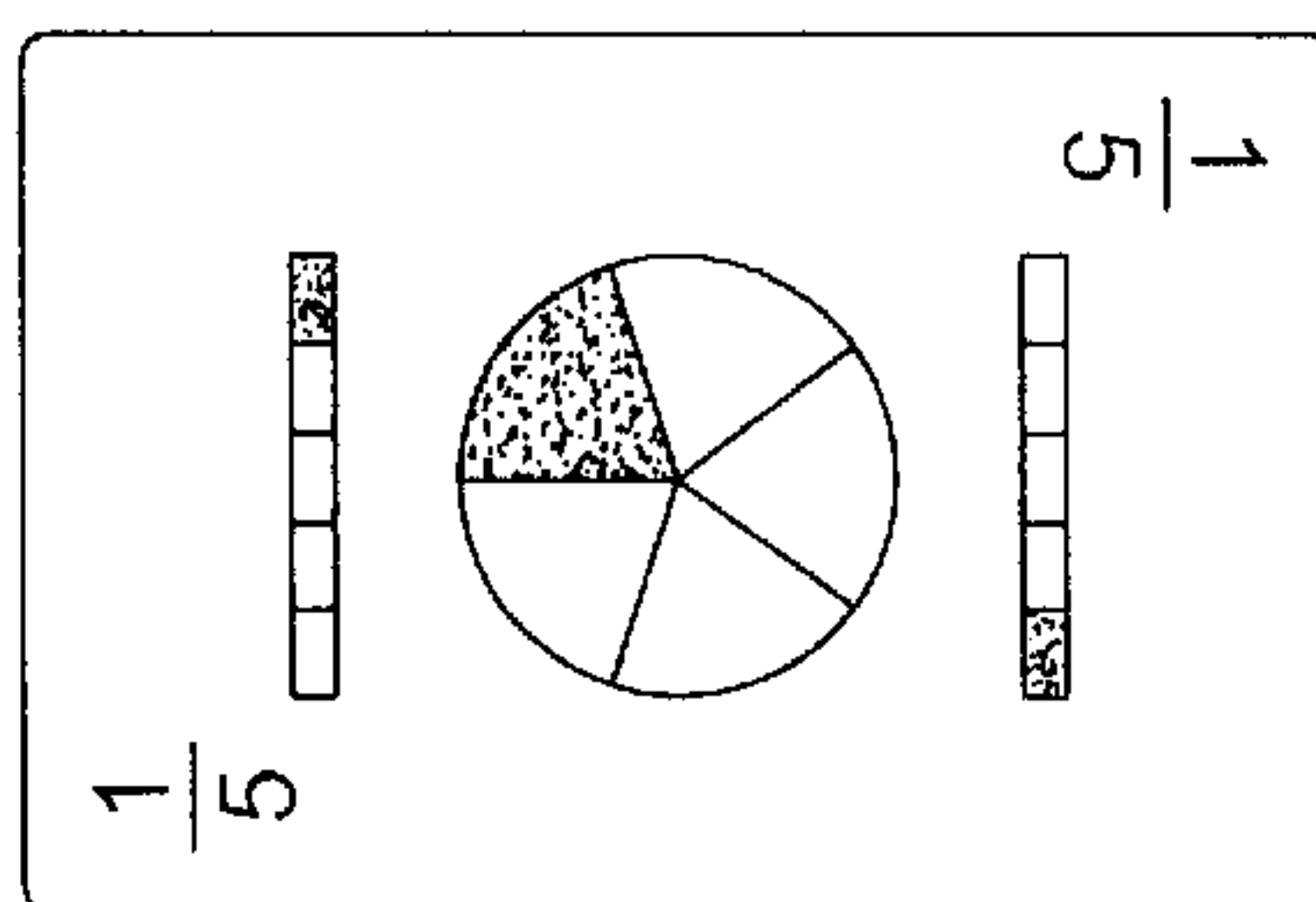

FIG. 6

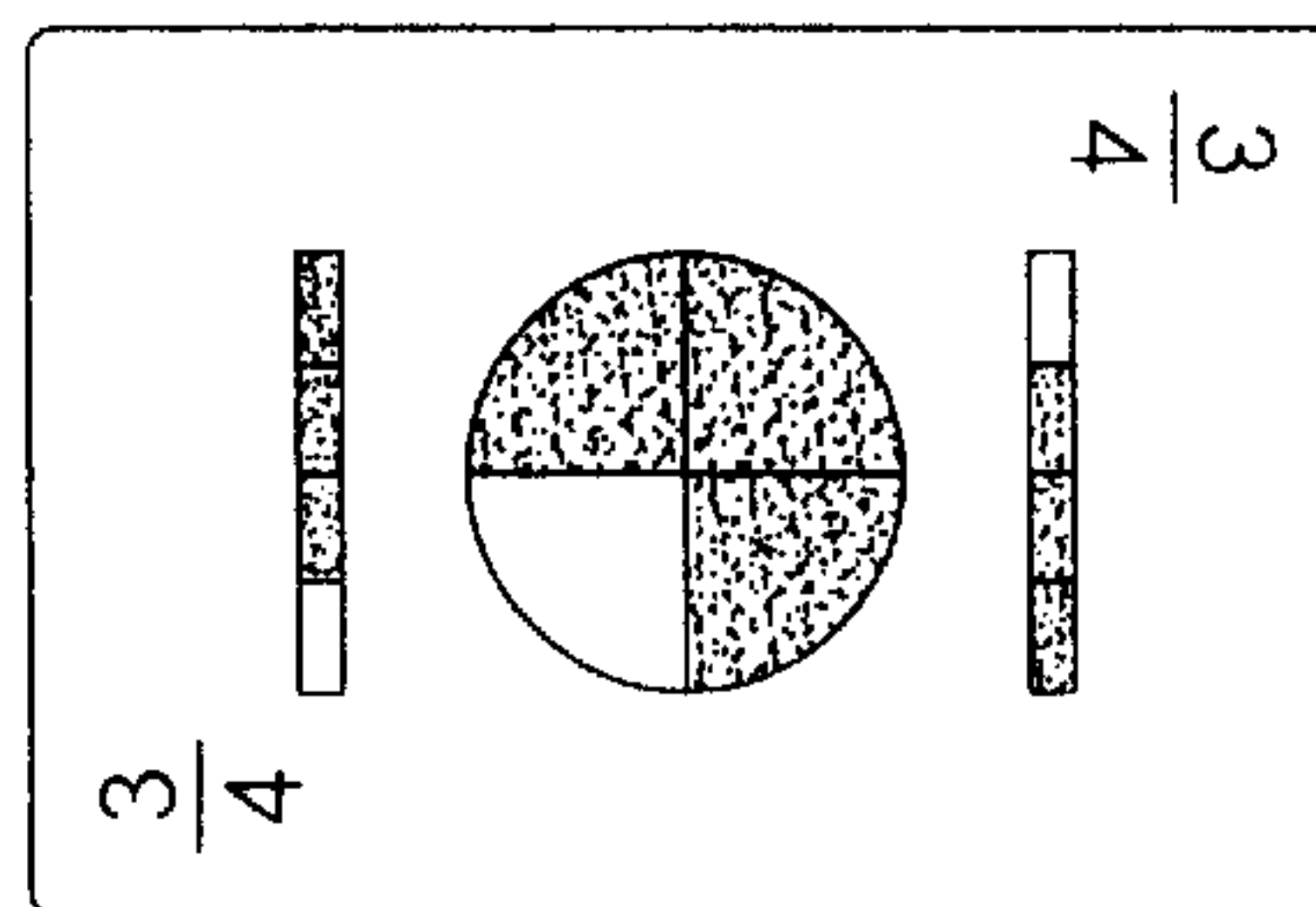

FIG. 7

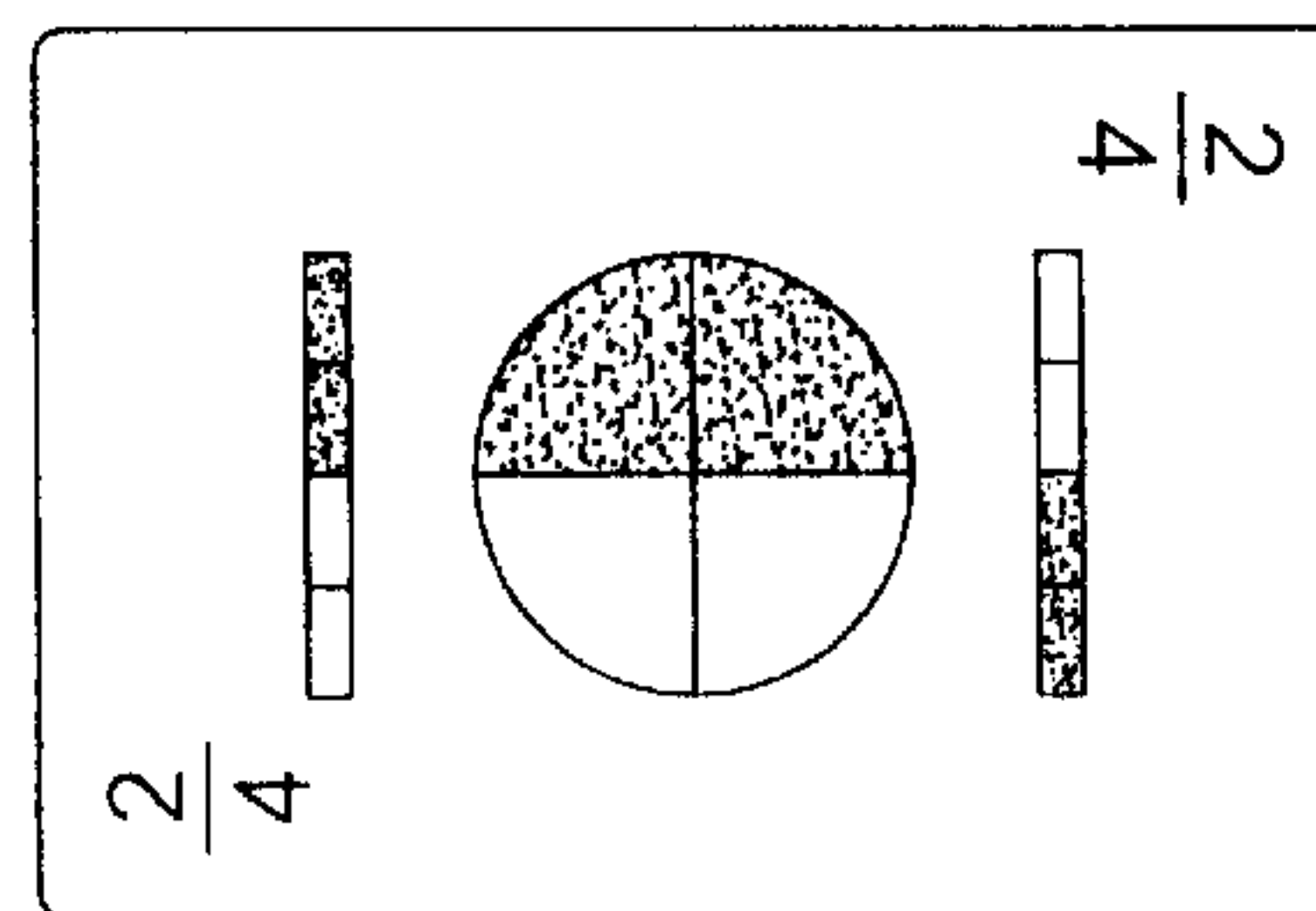

FIG. 8

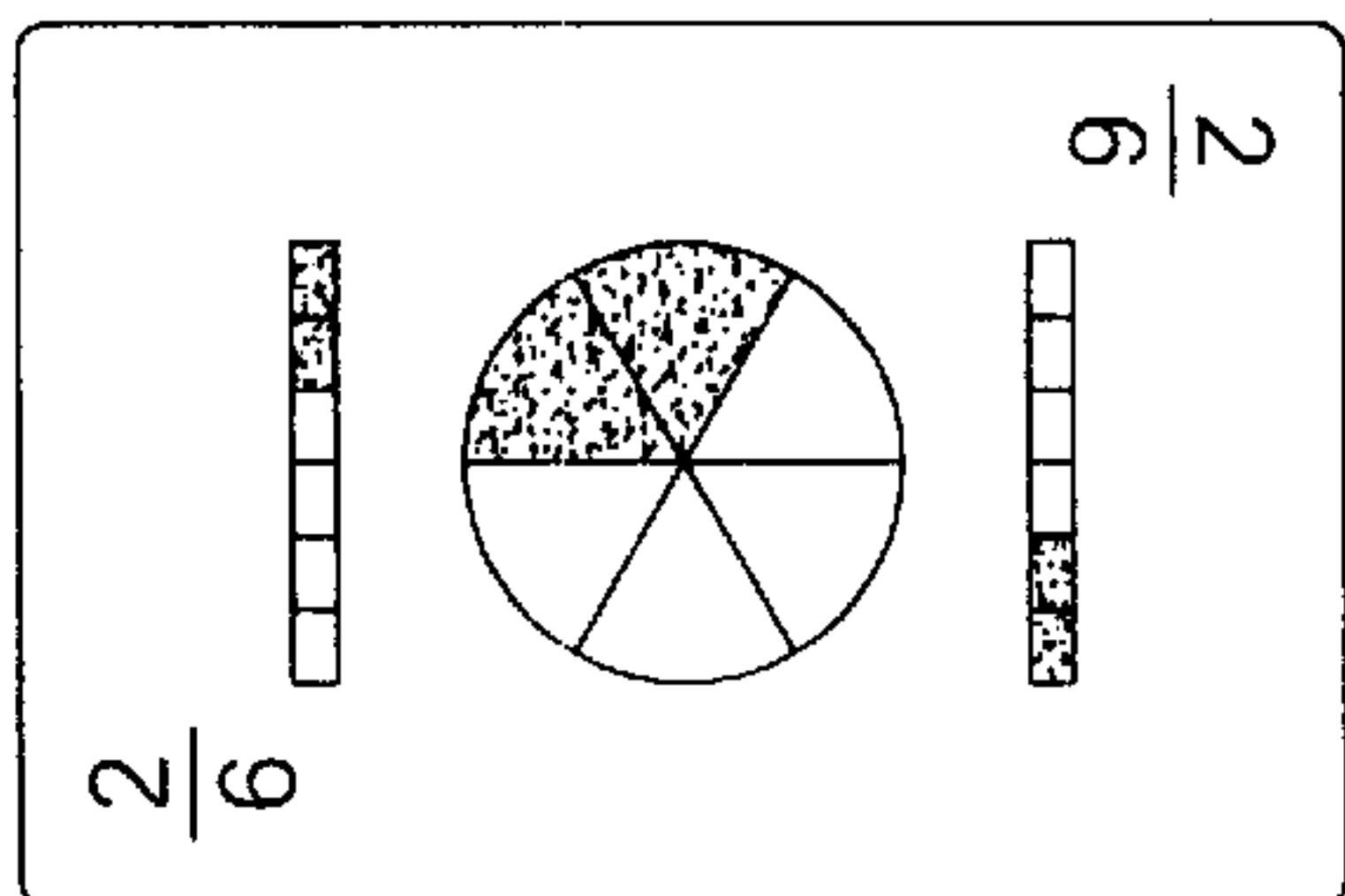

FIG. 9

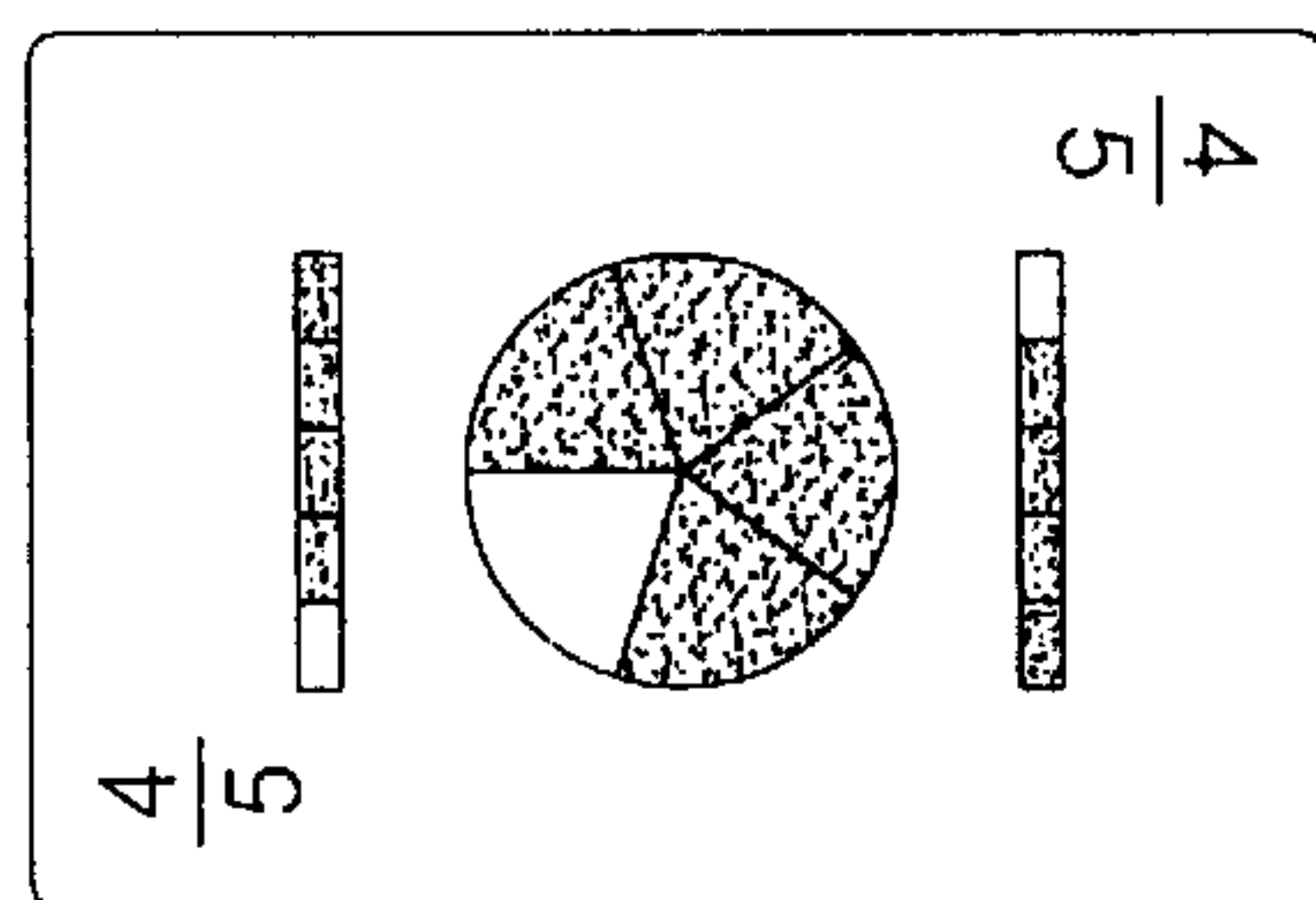

FIG. 10

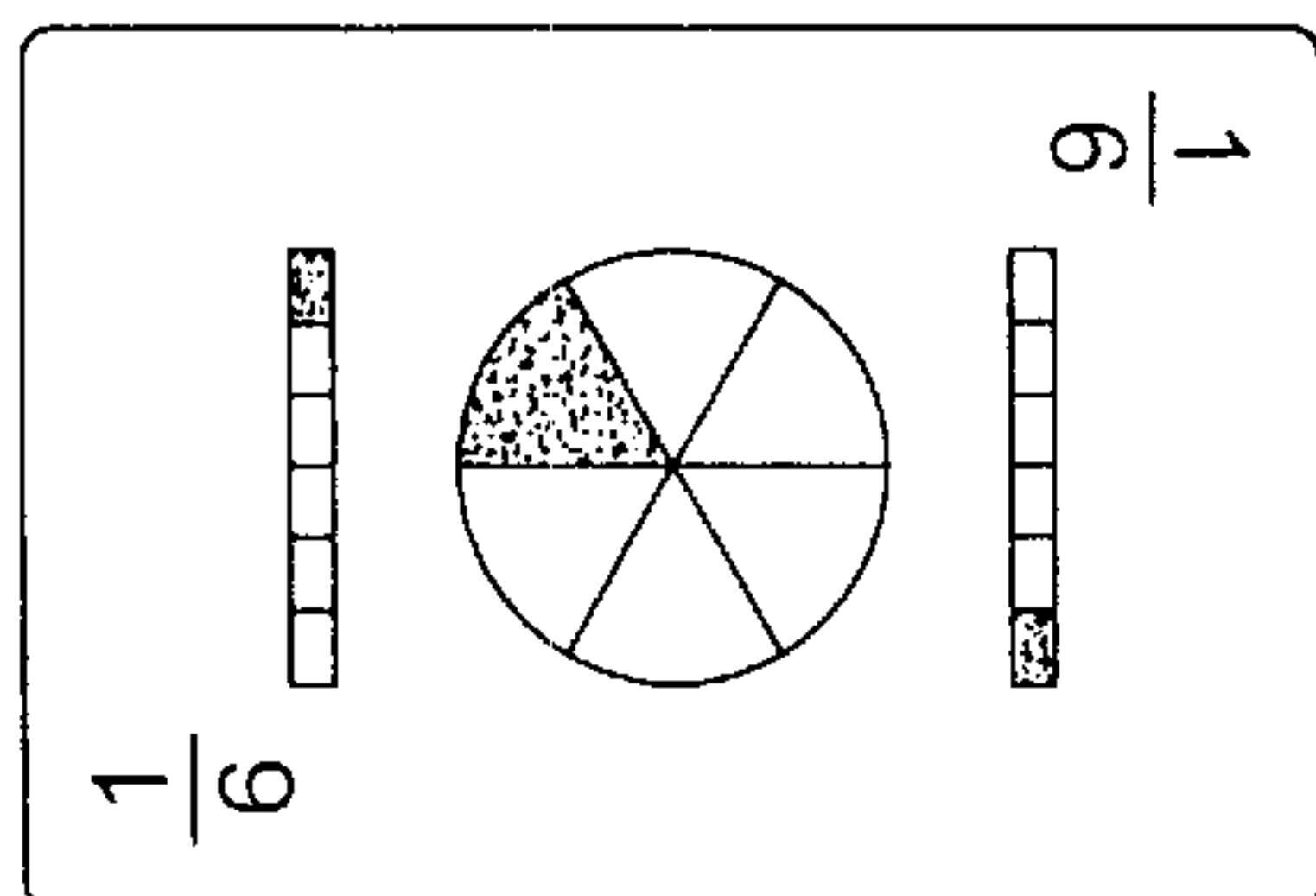

FIG. 11

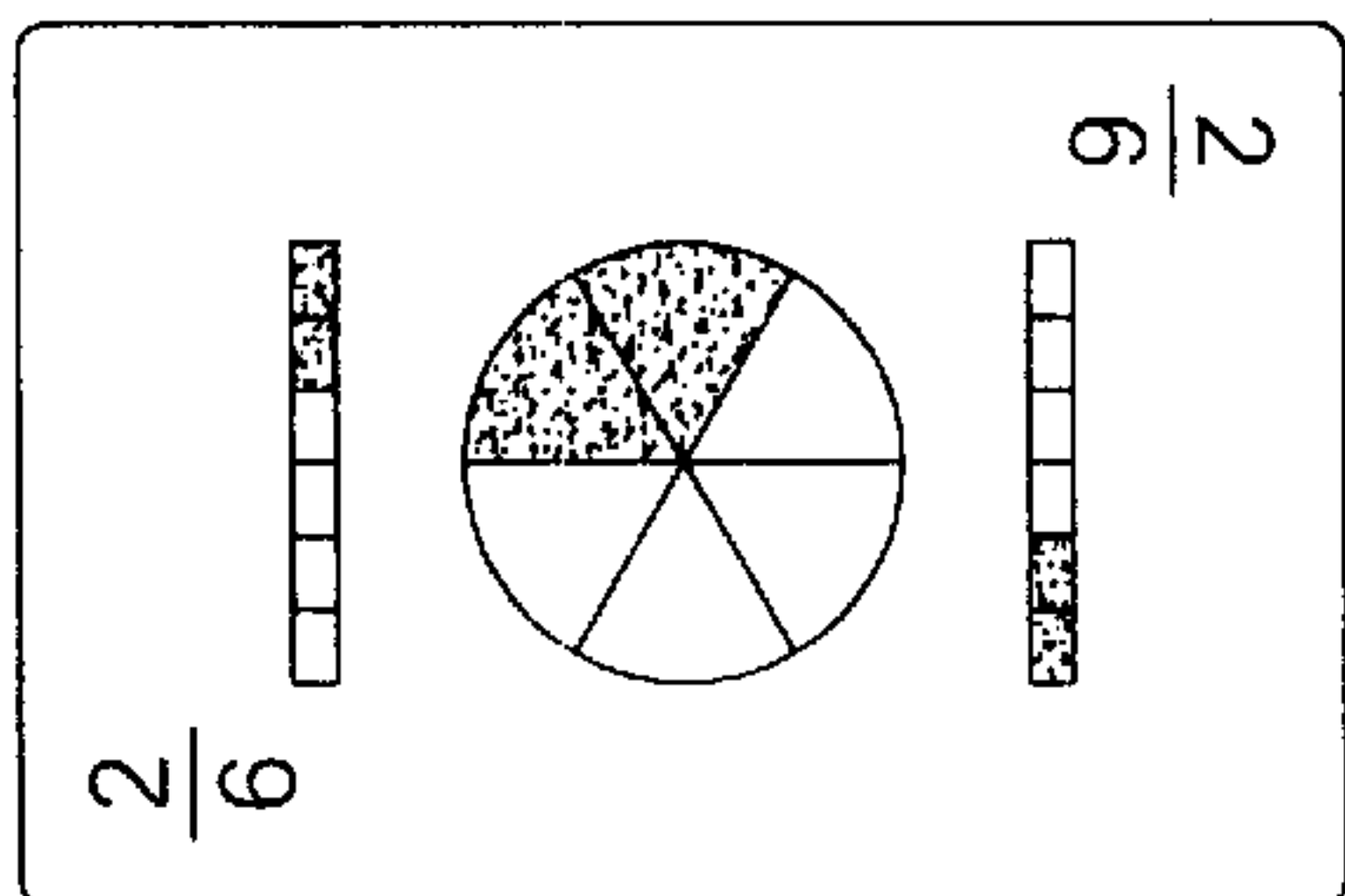

FIG. 12

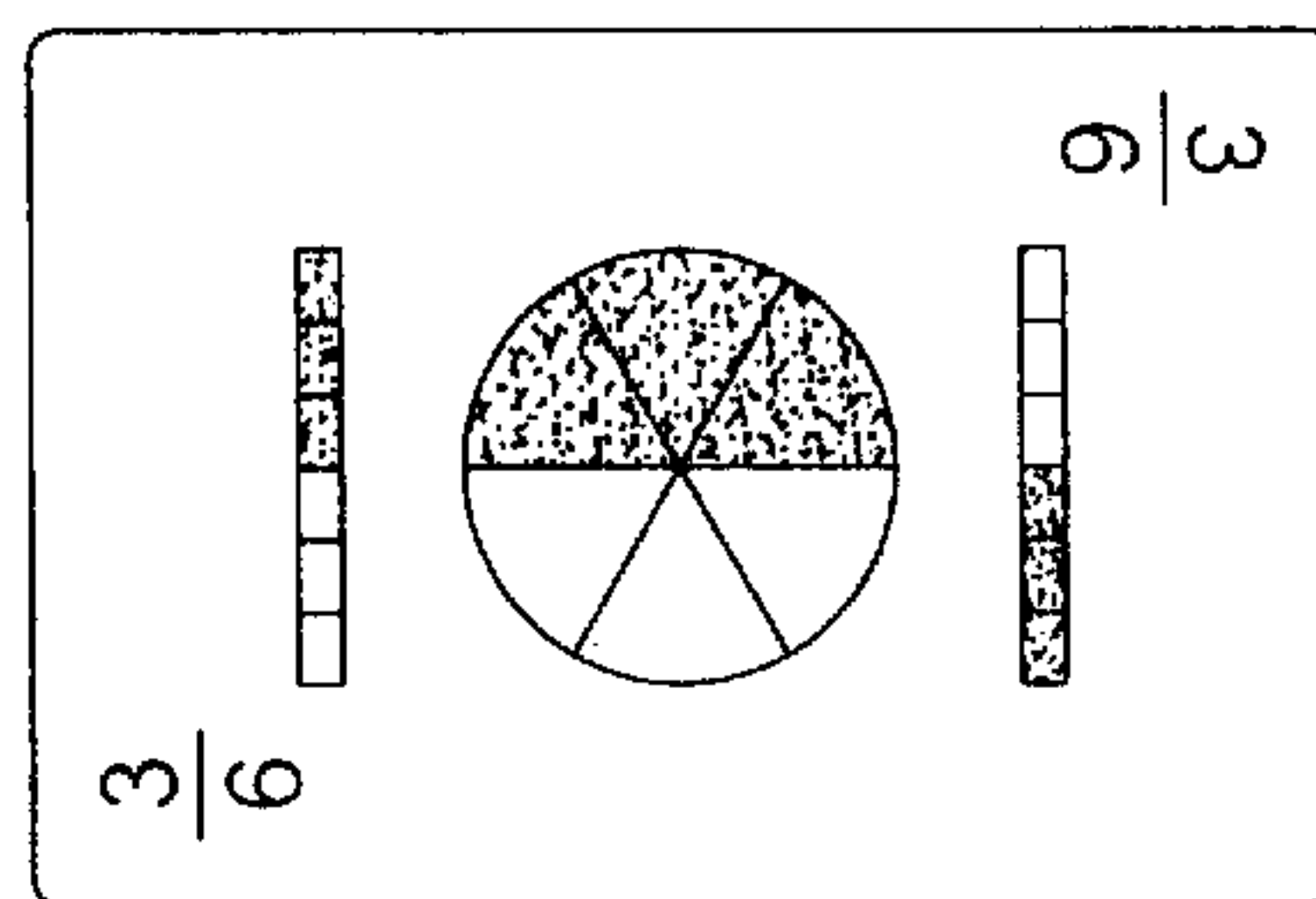

FIG. 13

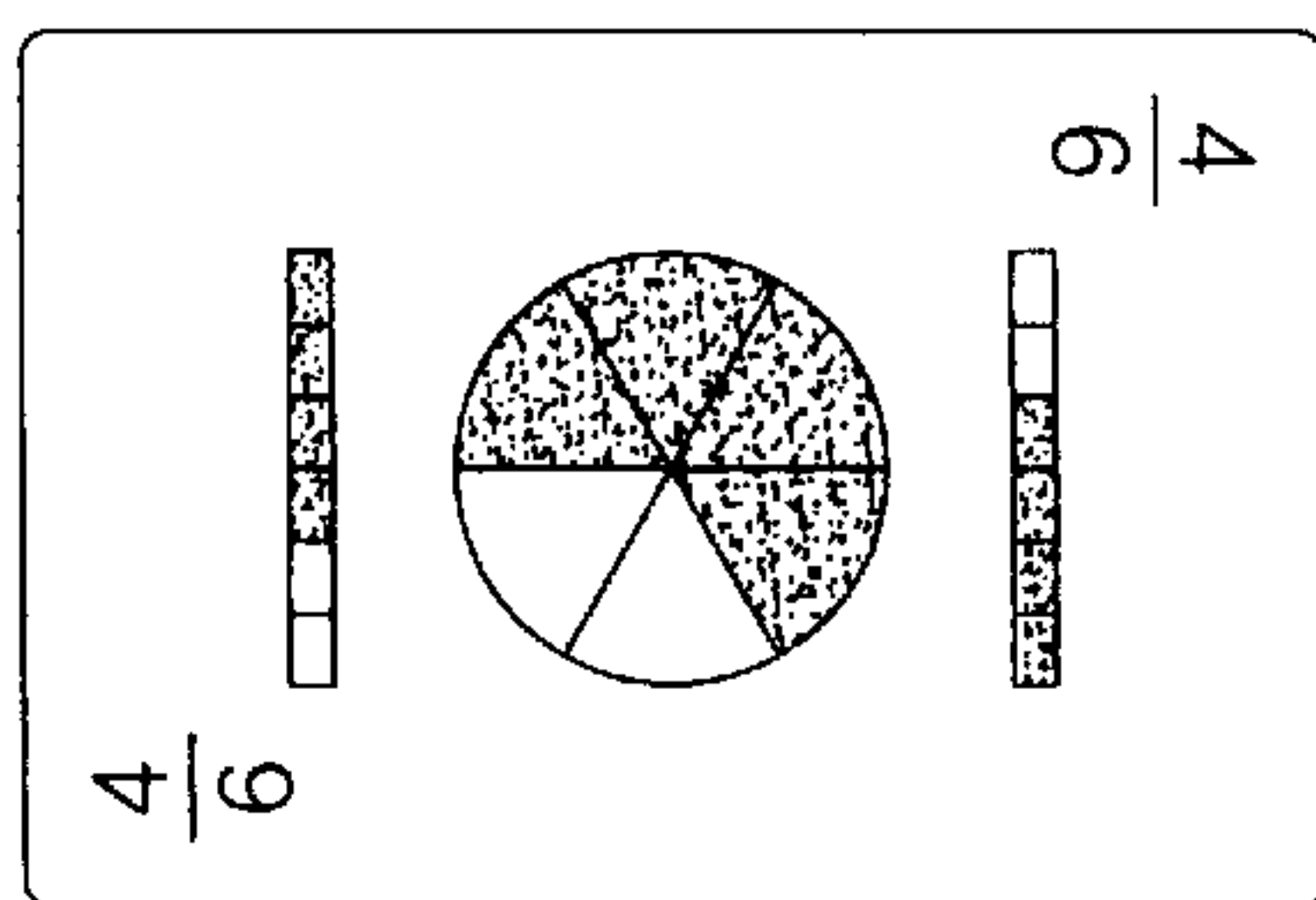

FIG. 14

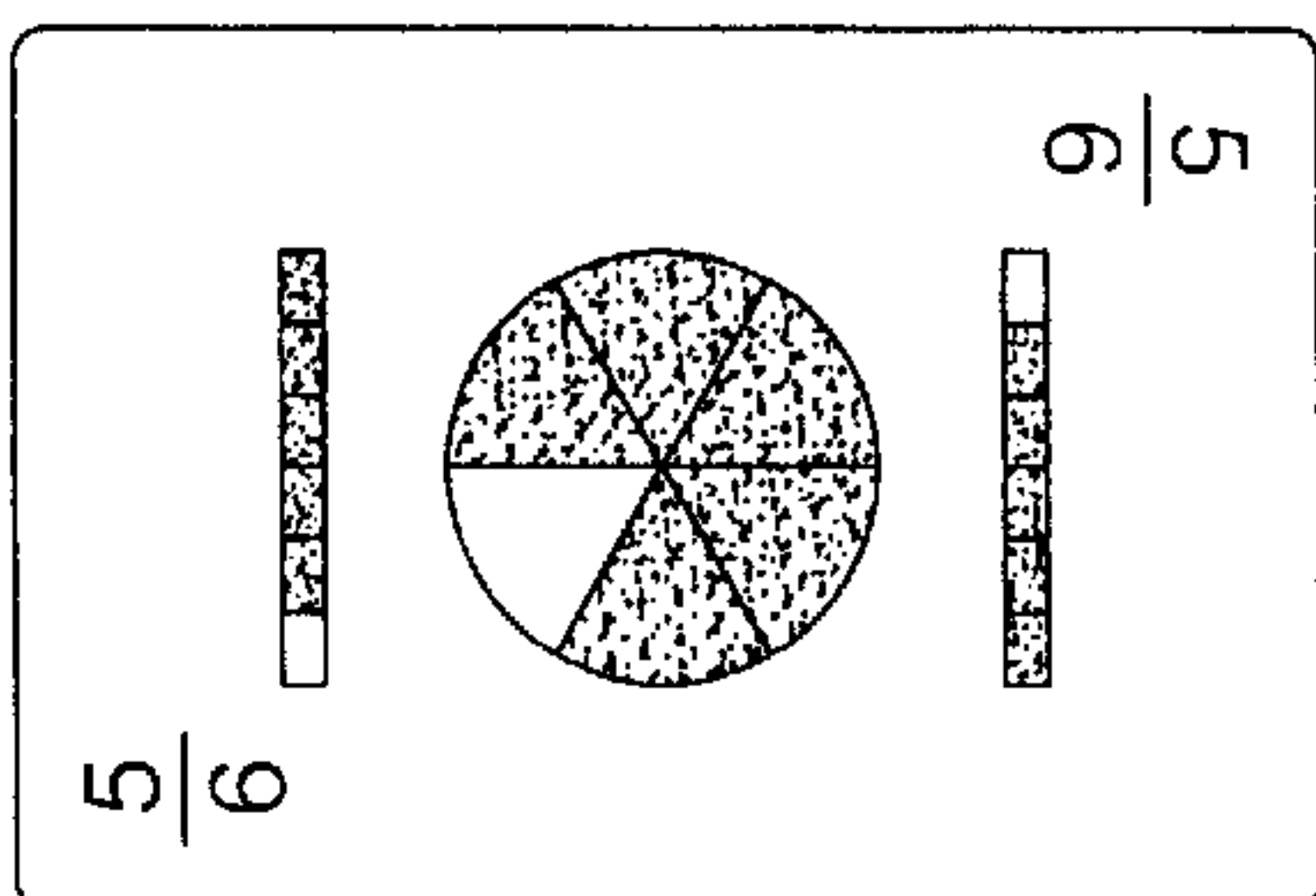

FIG. 15

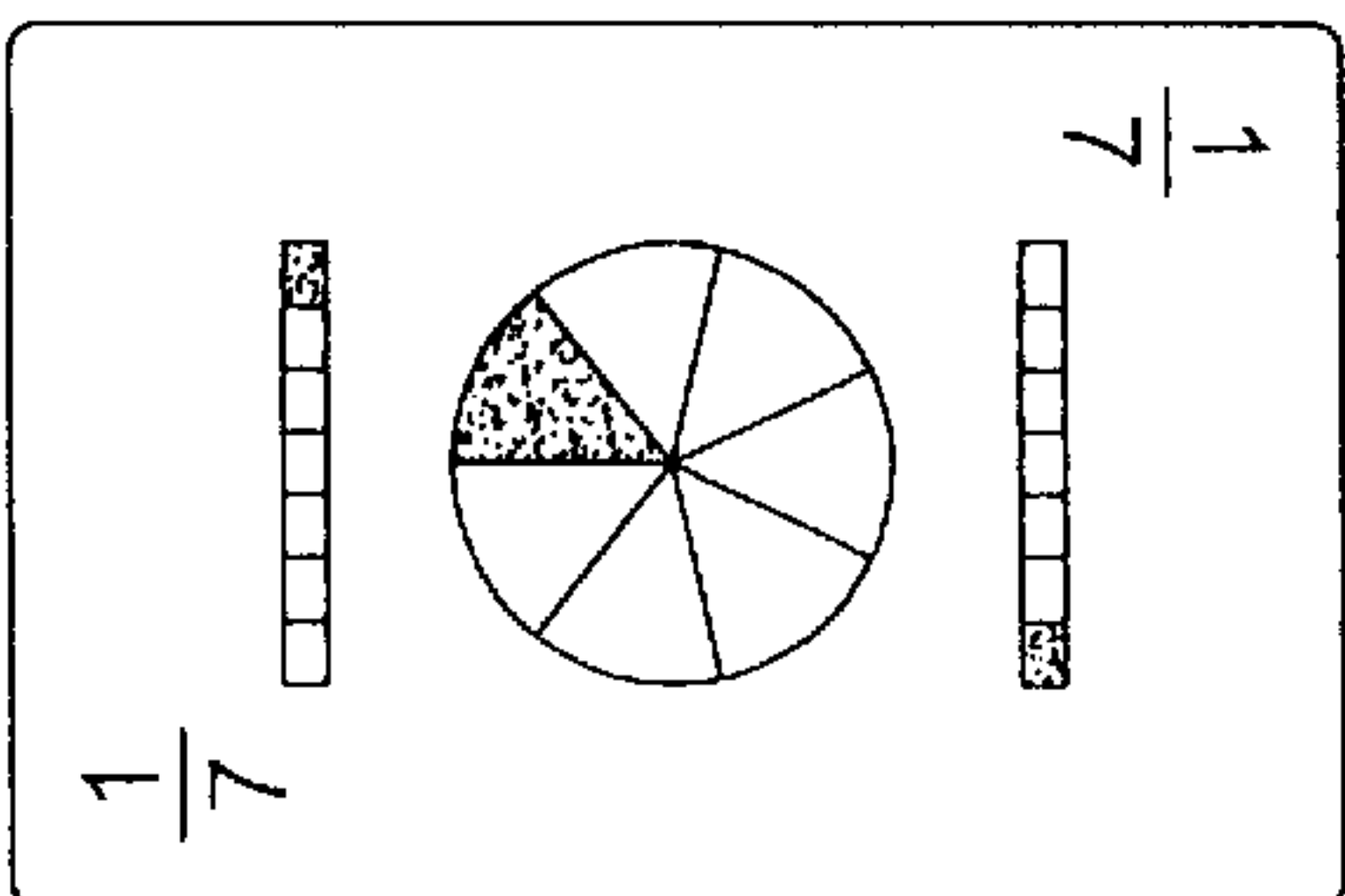

FIG. 16

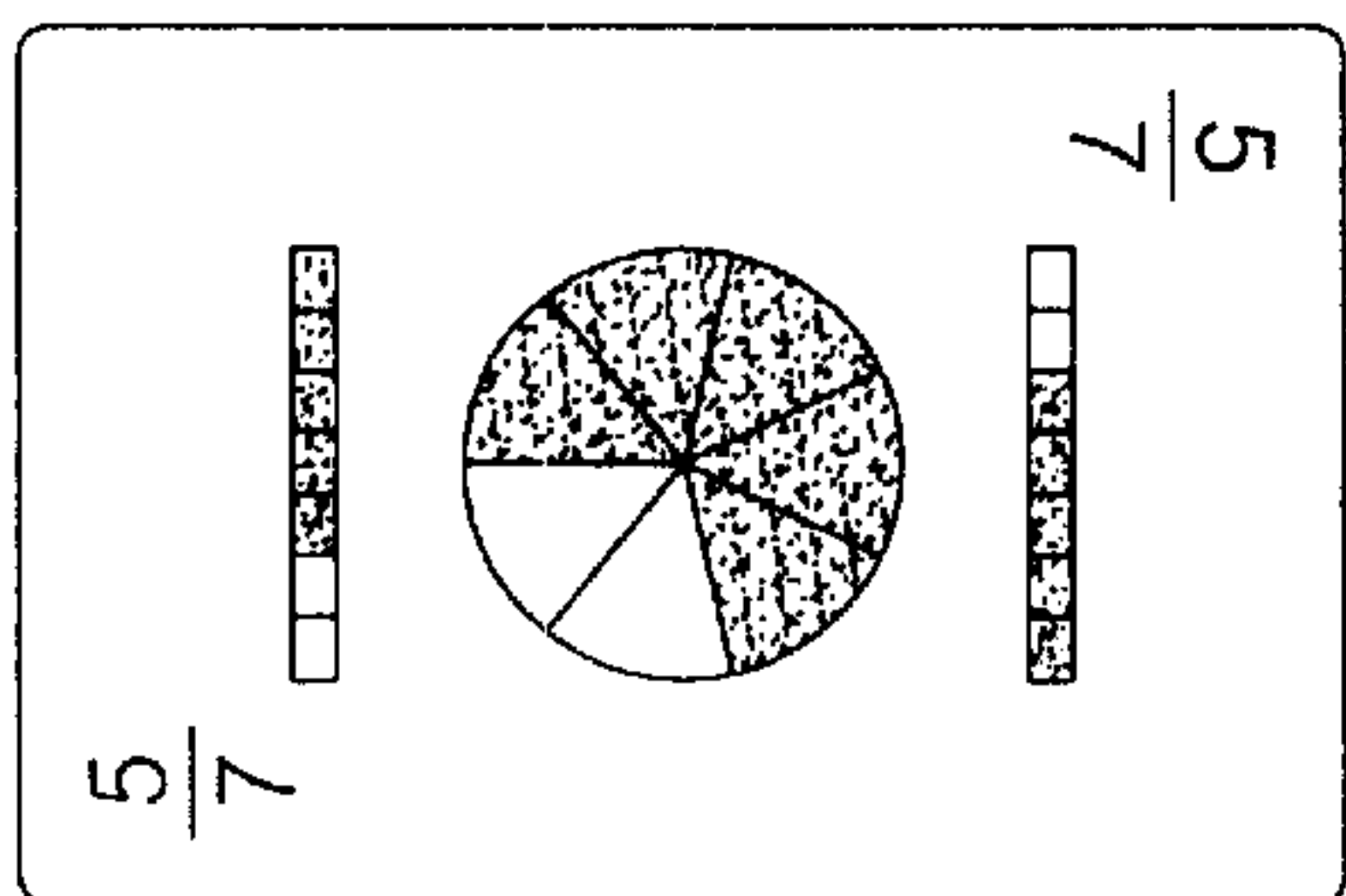

FIG. 17

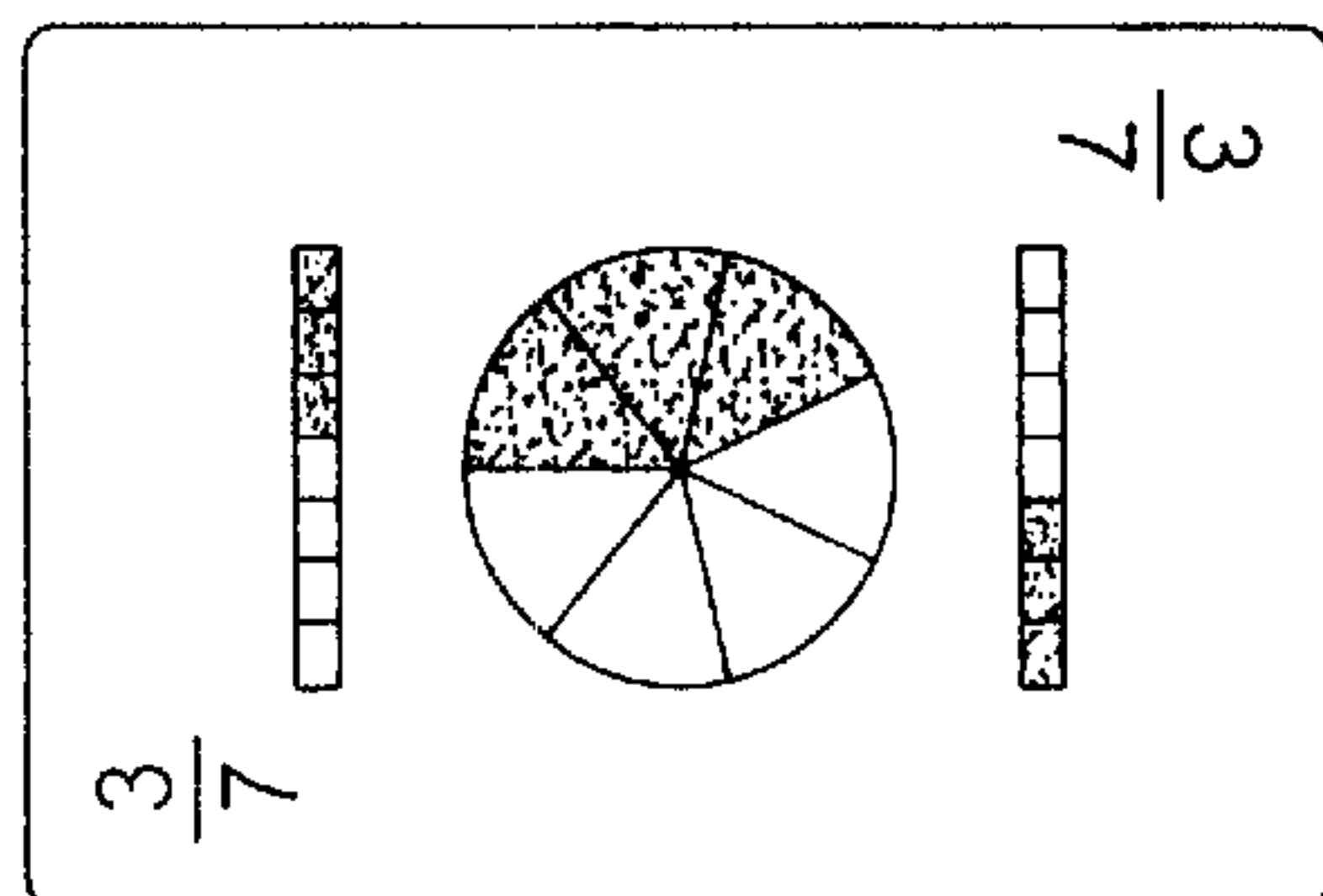

FIG. 18

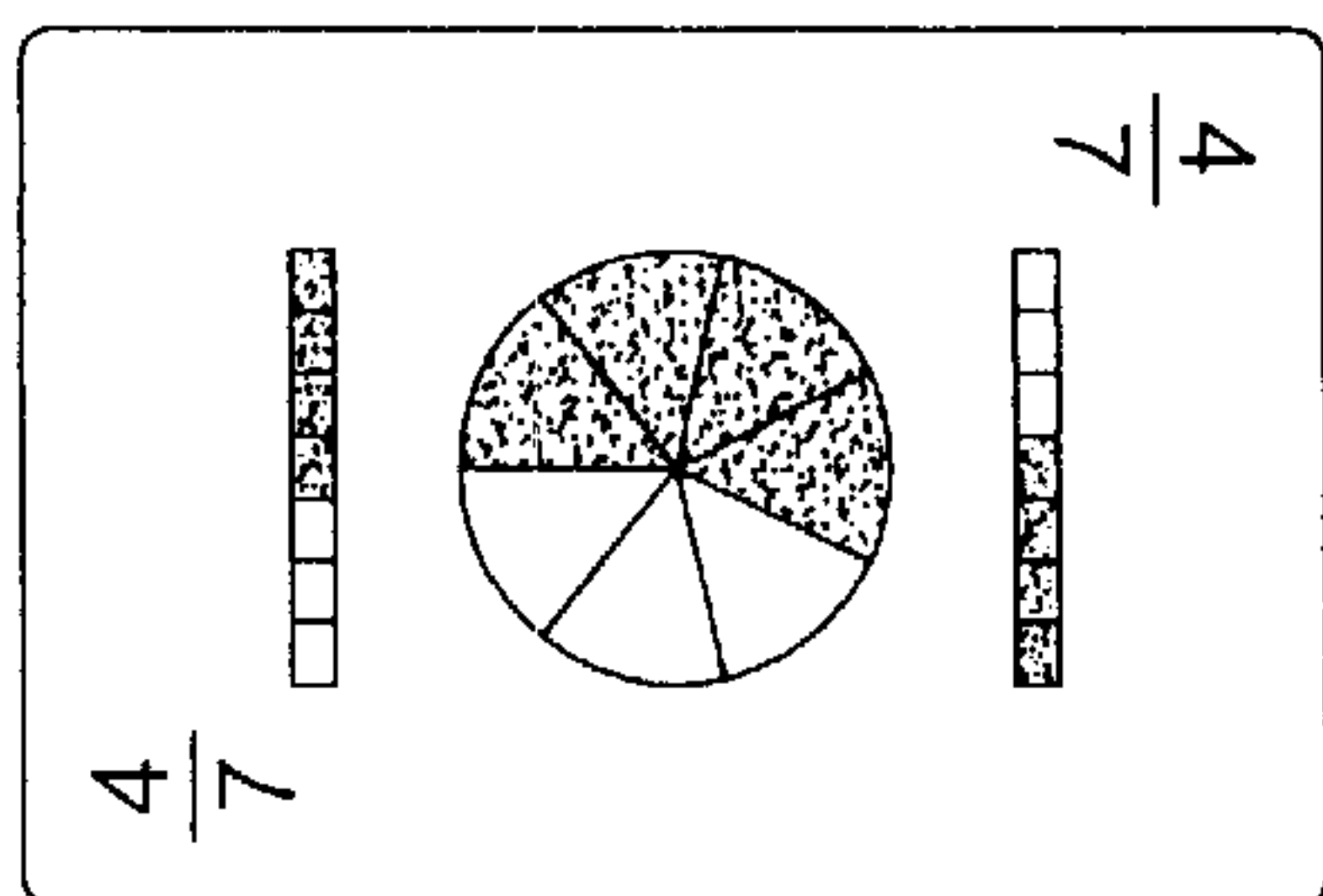

FIG. 19

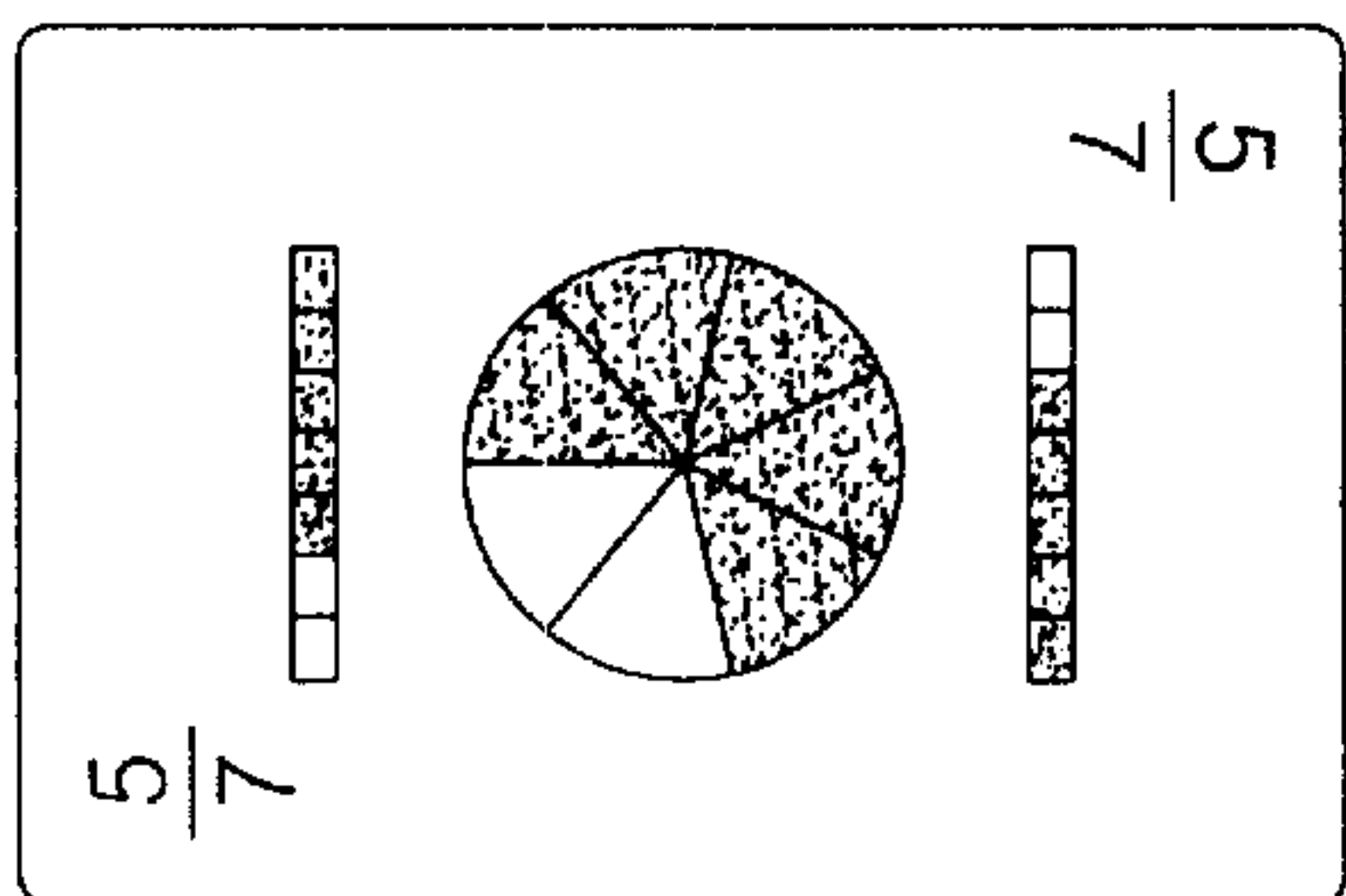

FIG. 20

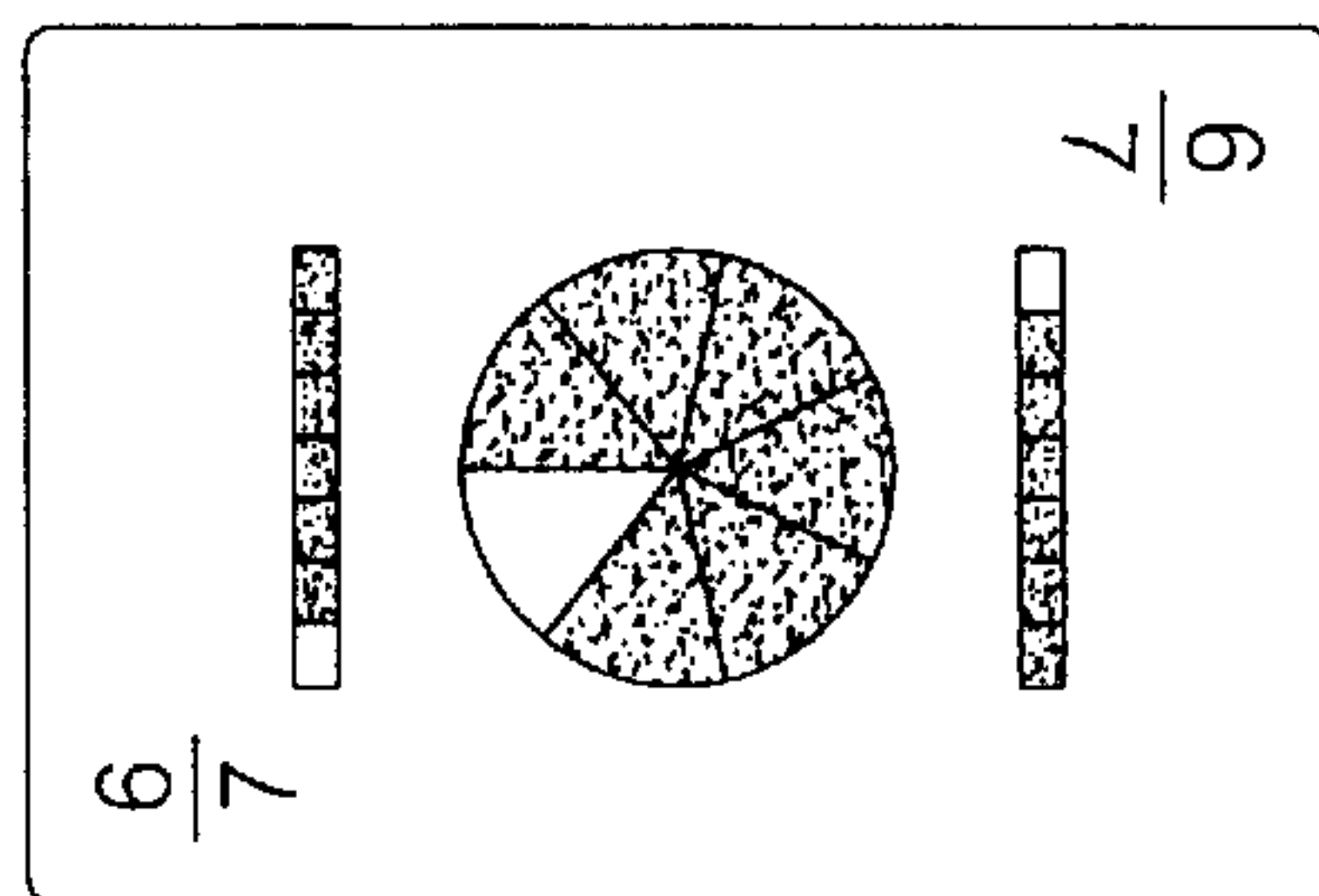

FIG. 21

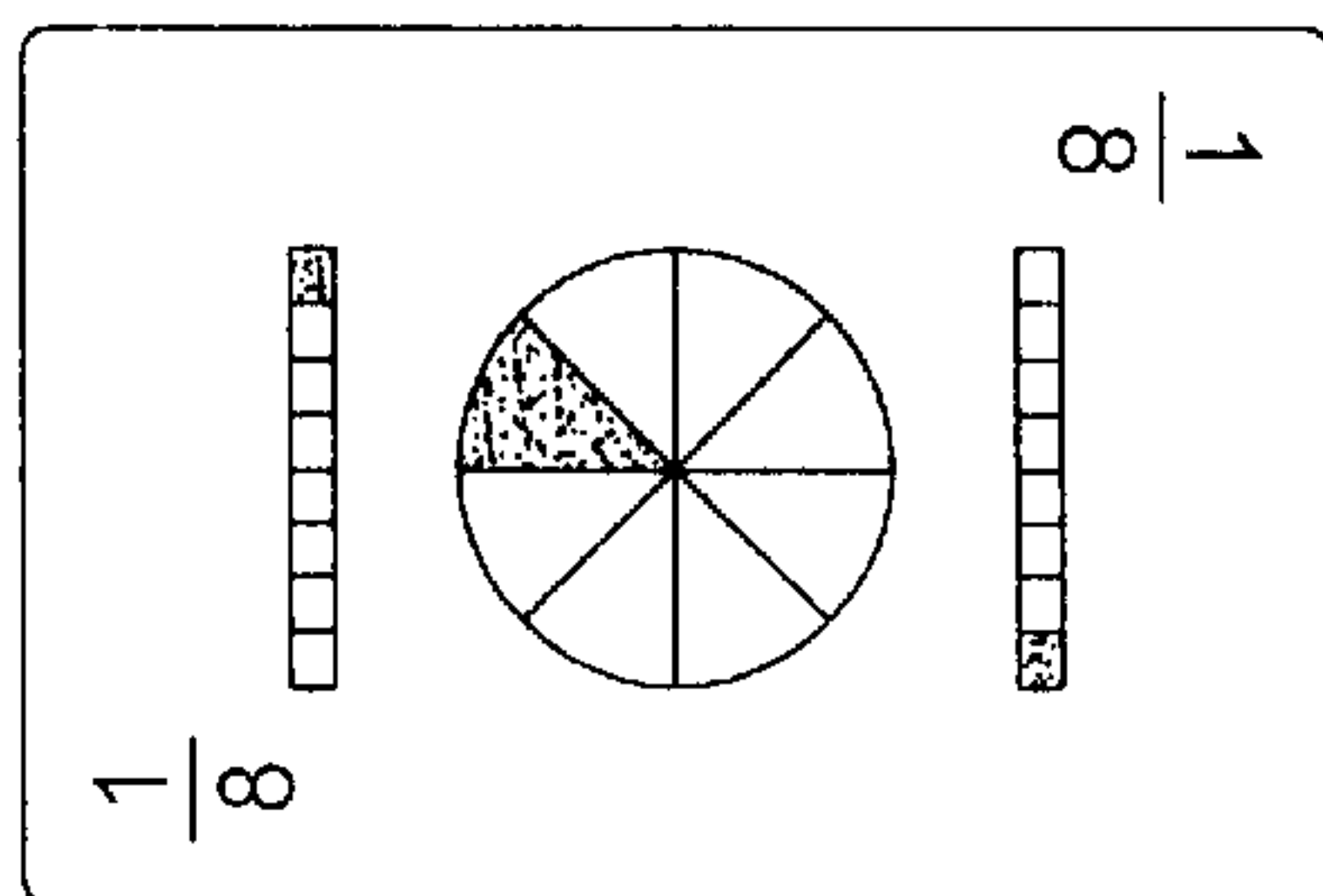

FIG. 22

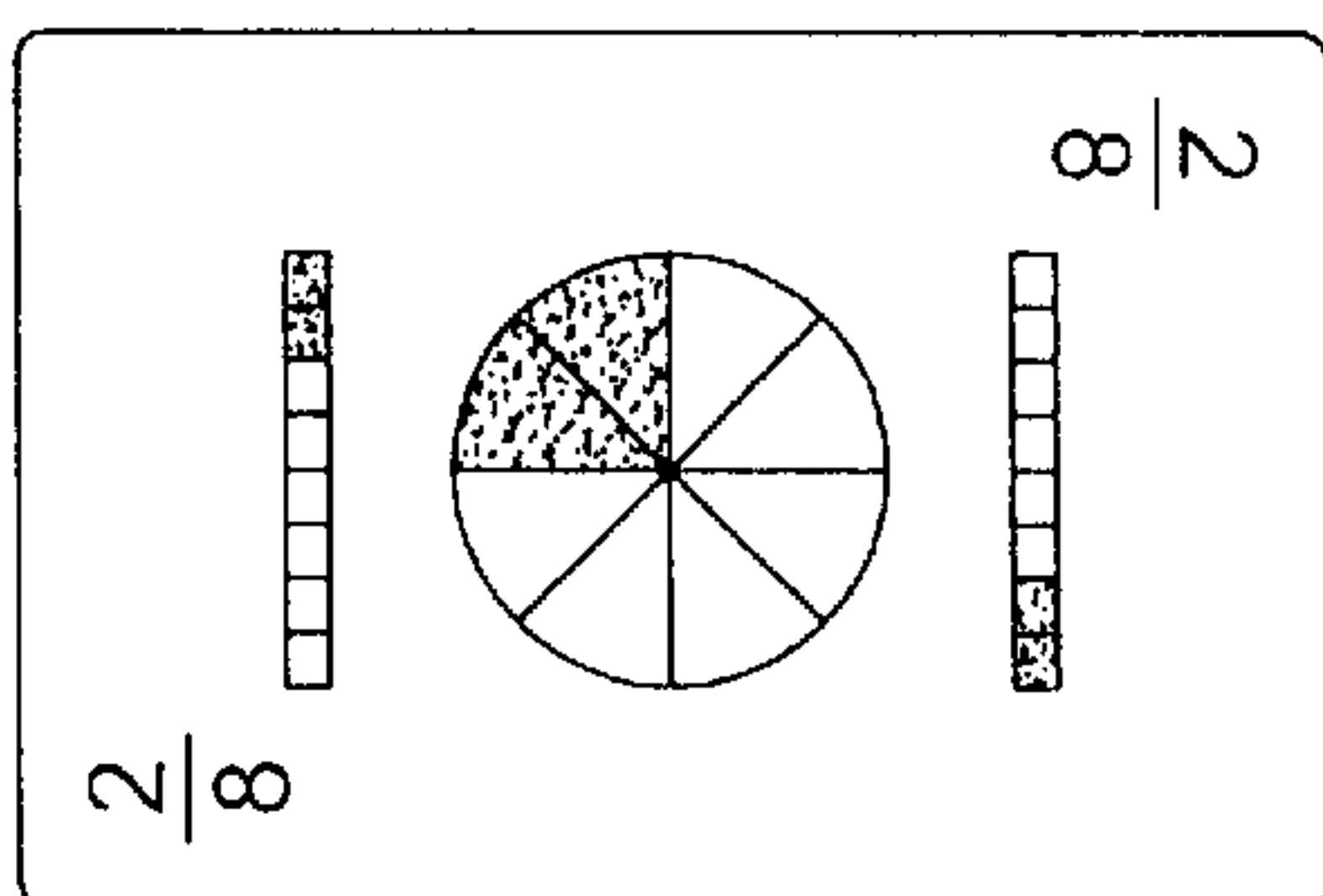

FIG. 23

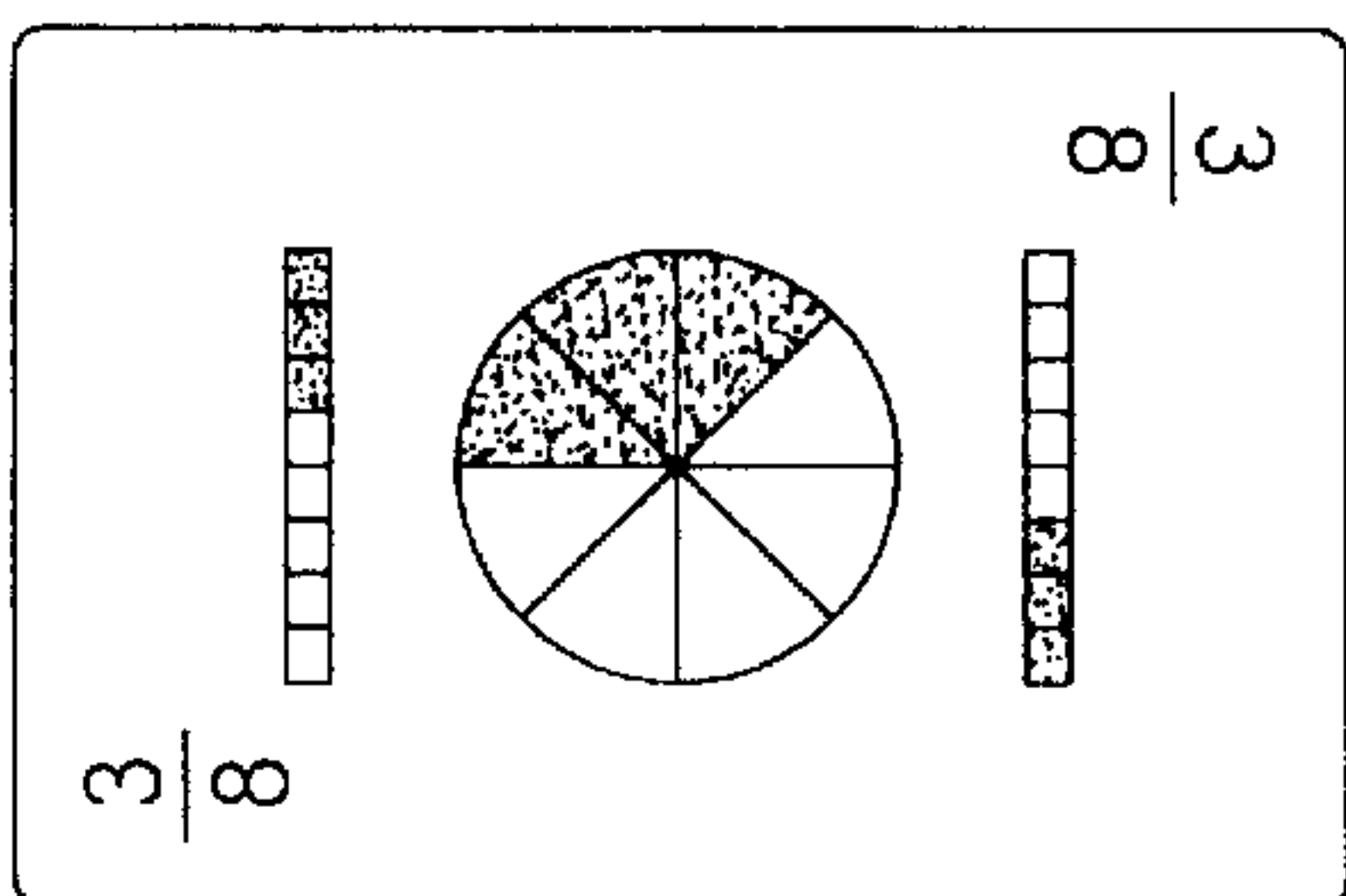

FIG. 24



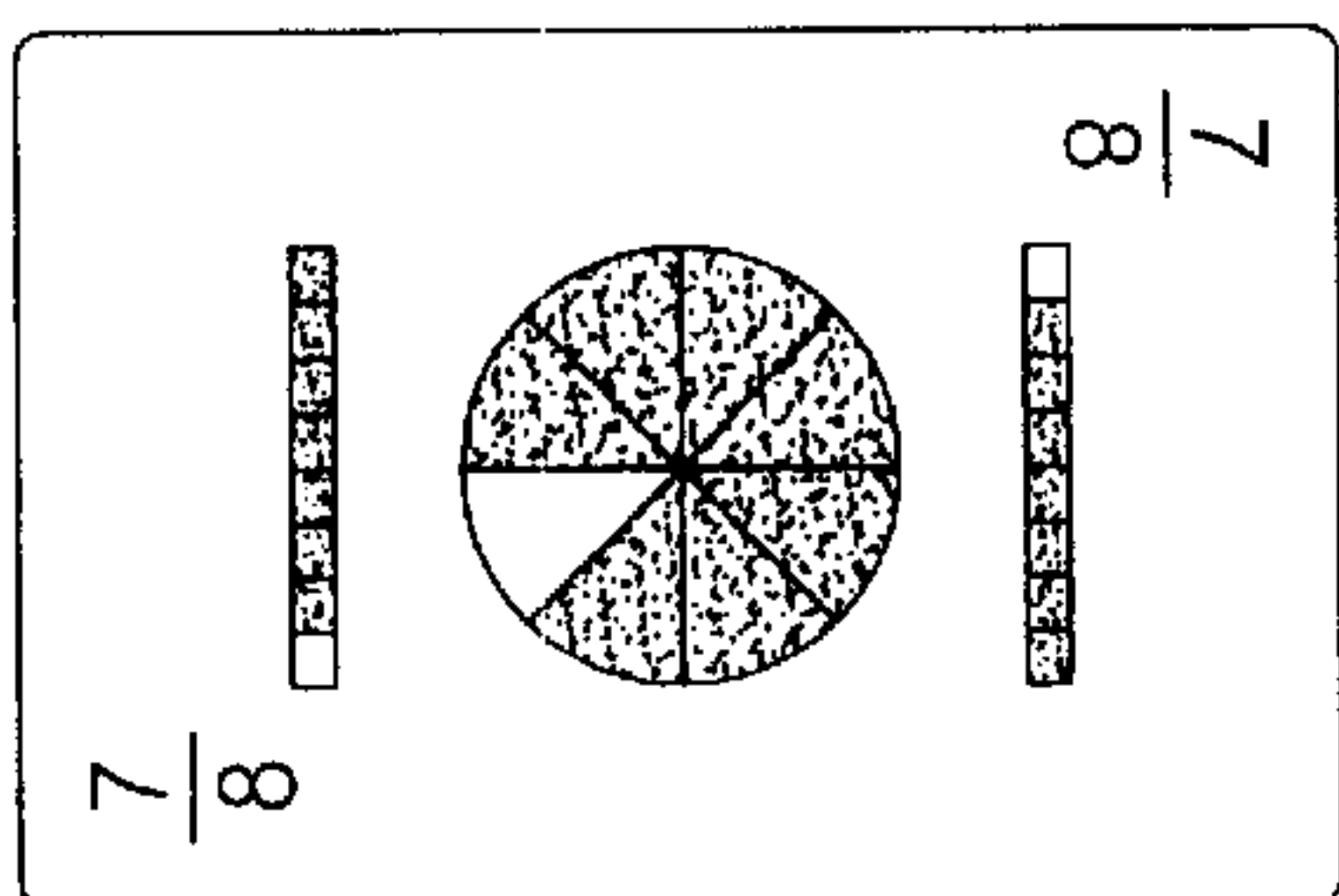

FIG. 25

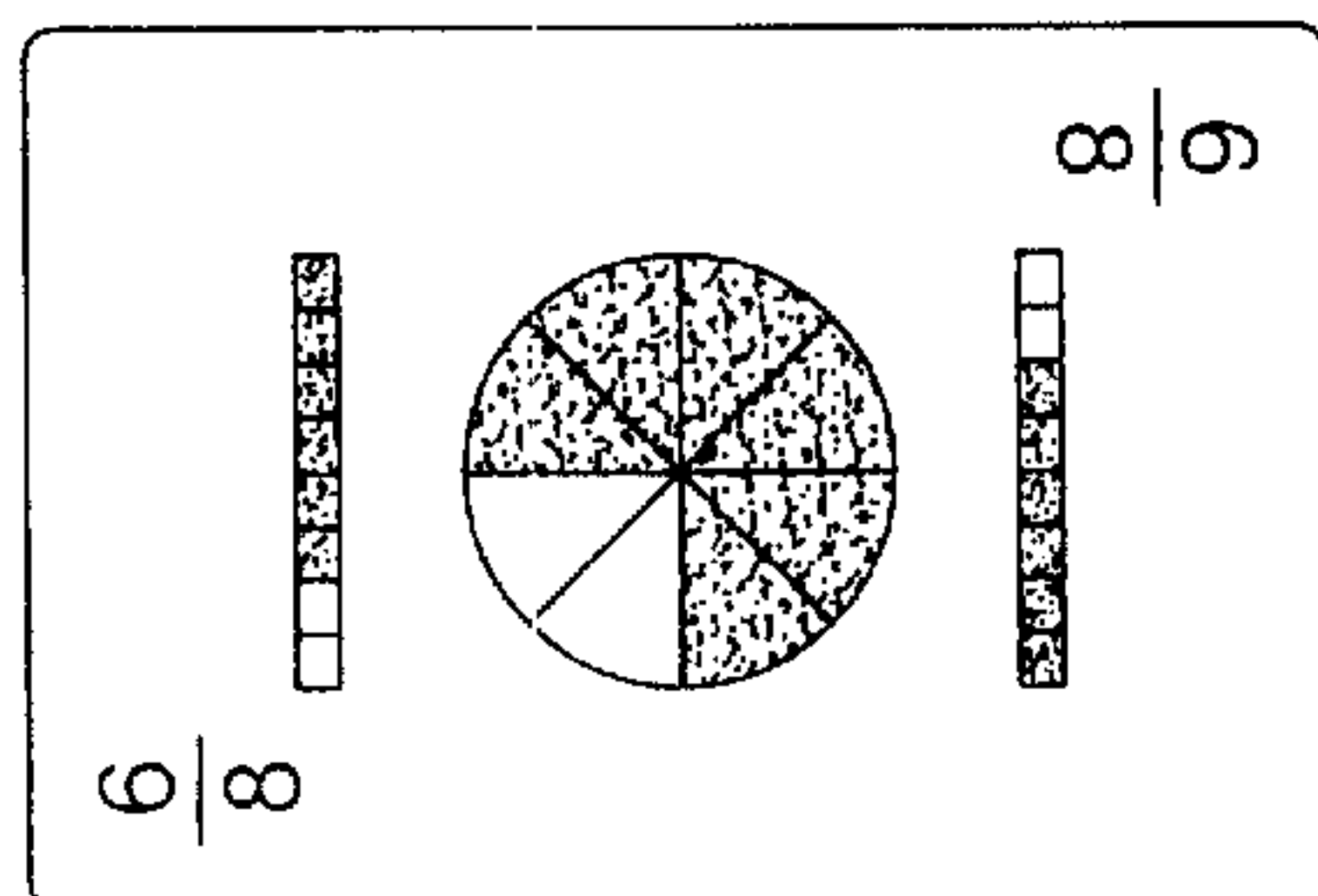

FIG. 26

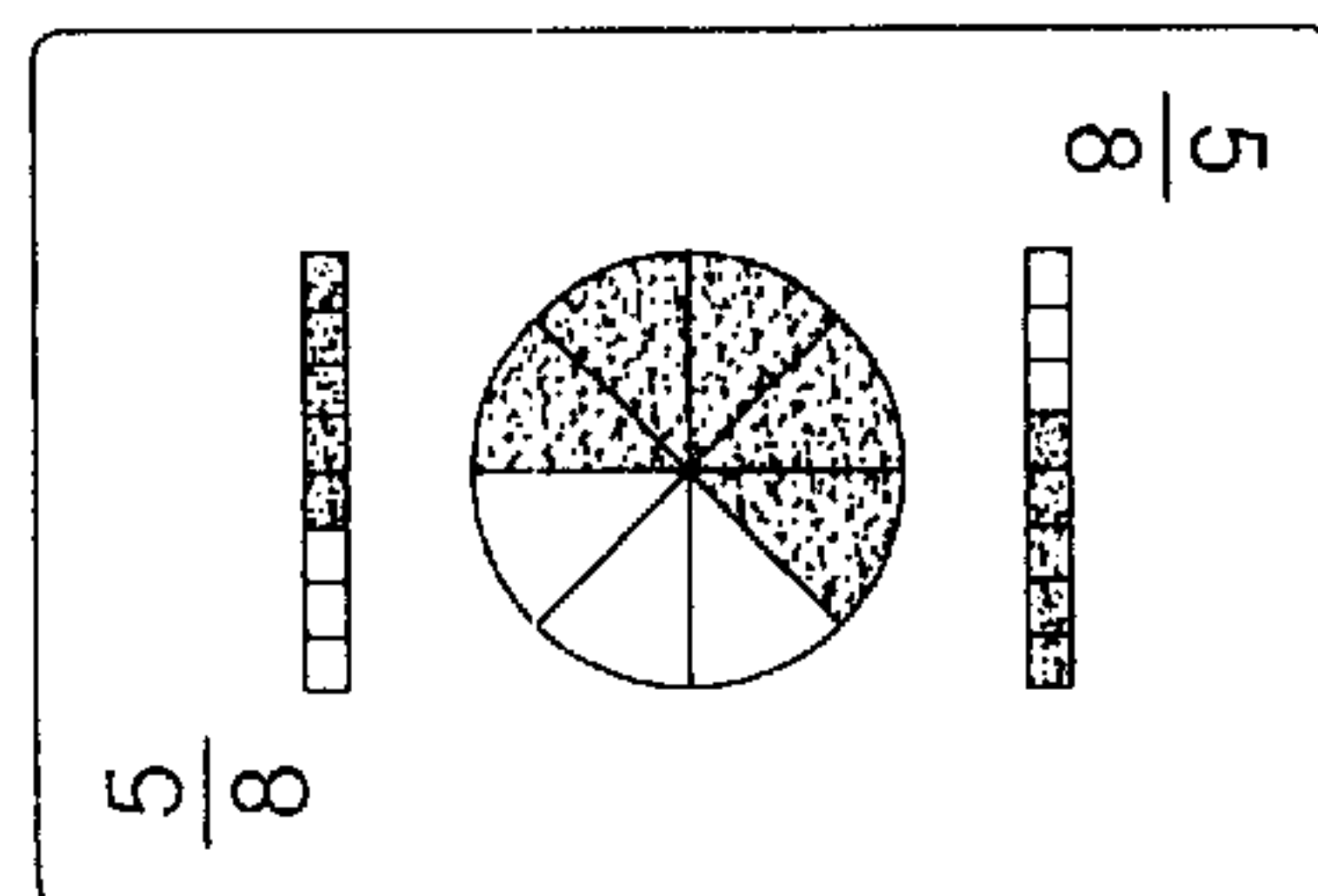

FIG. 27

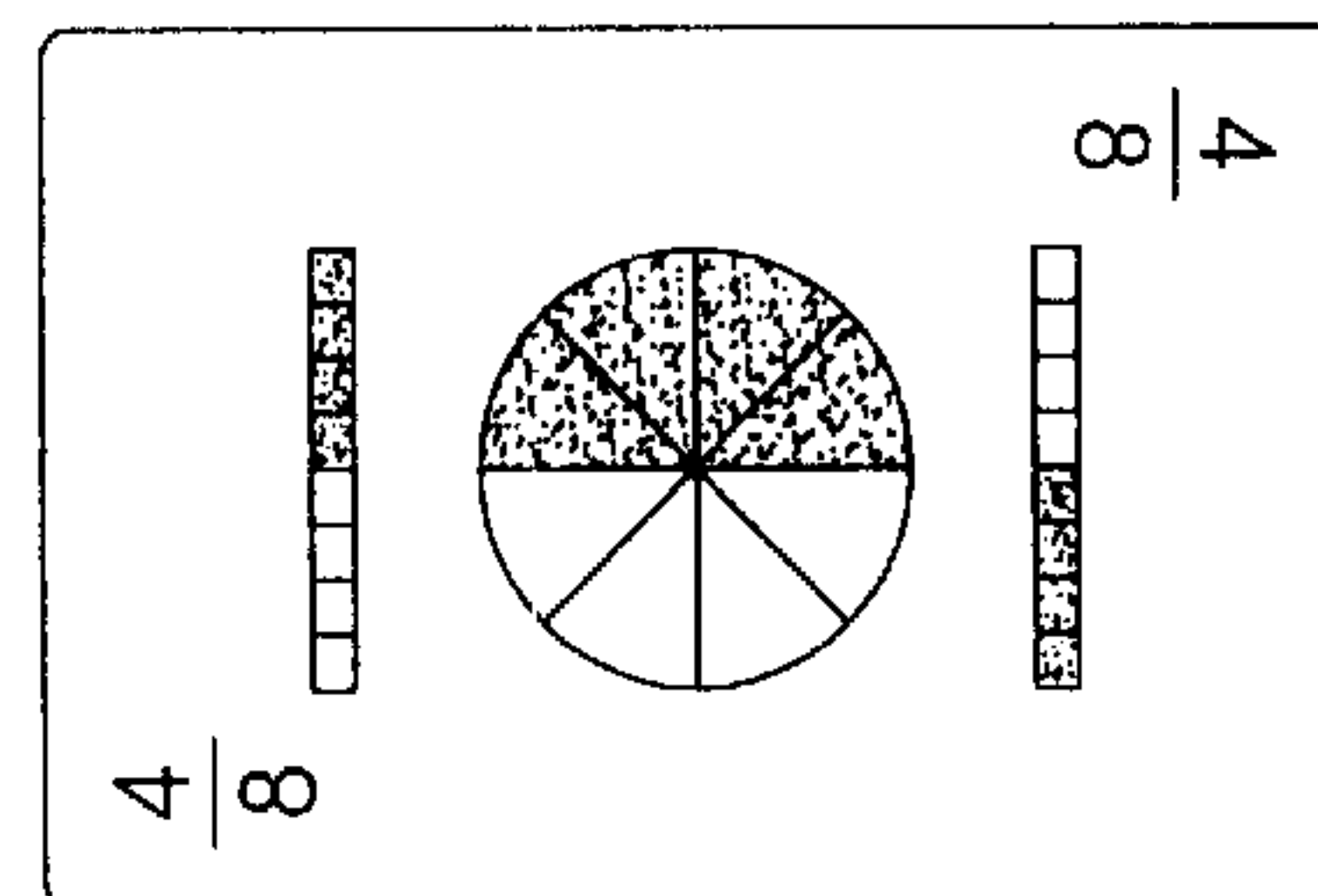

FIG. 28

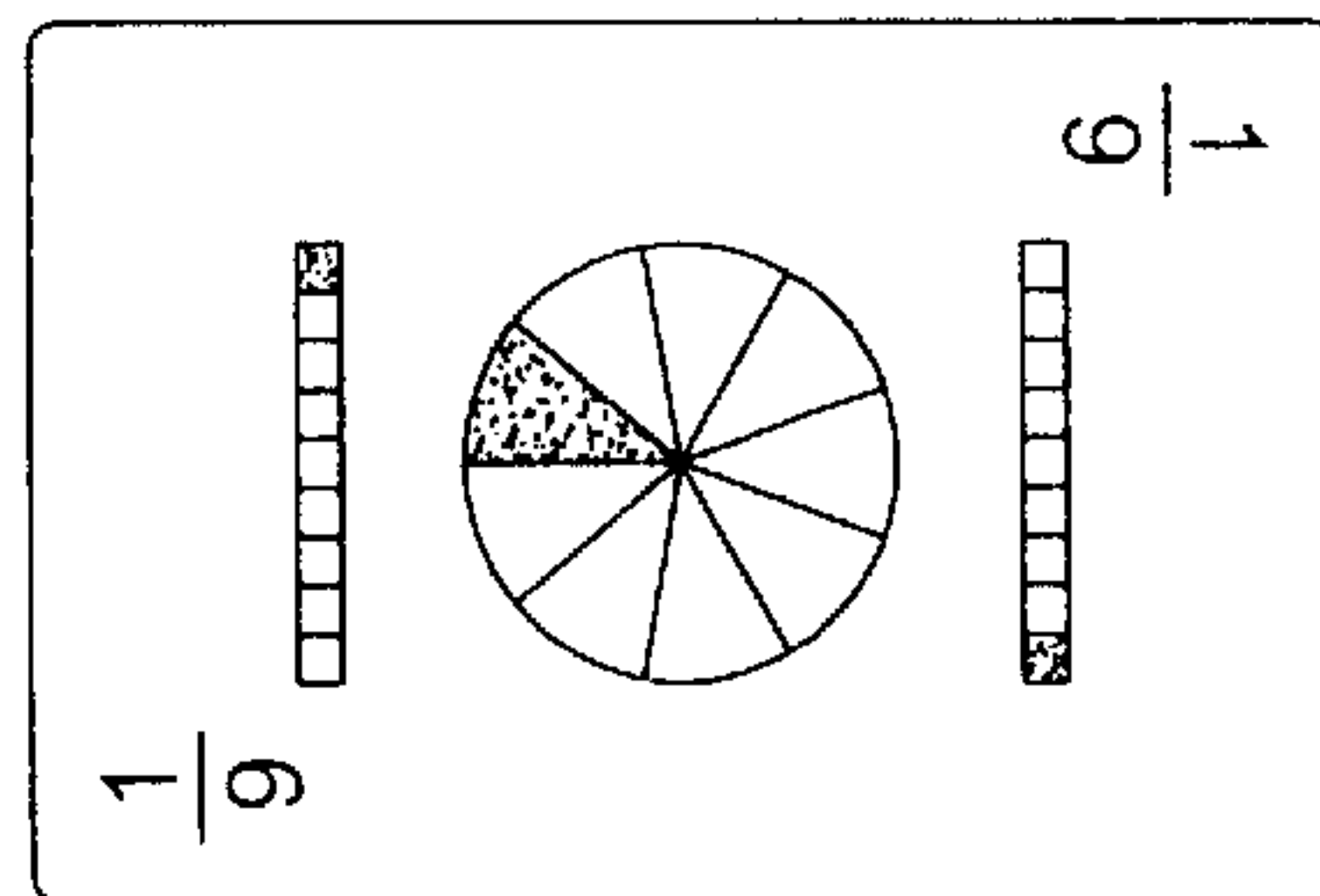

FIG. 29

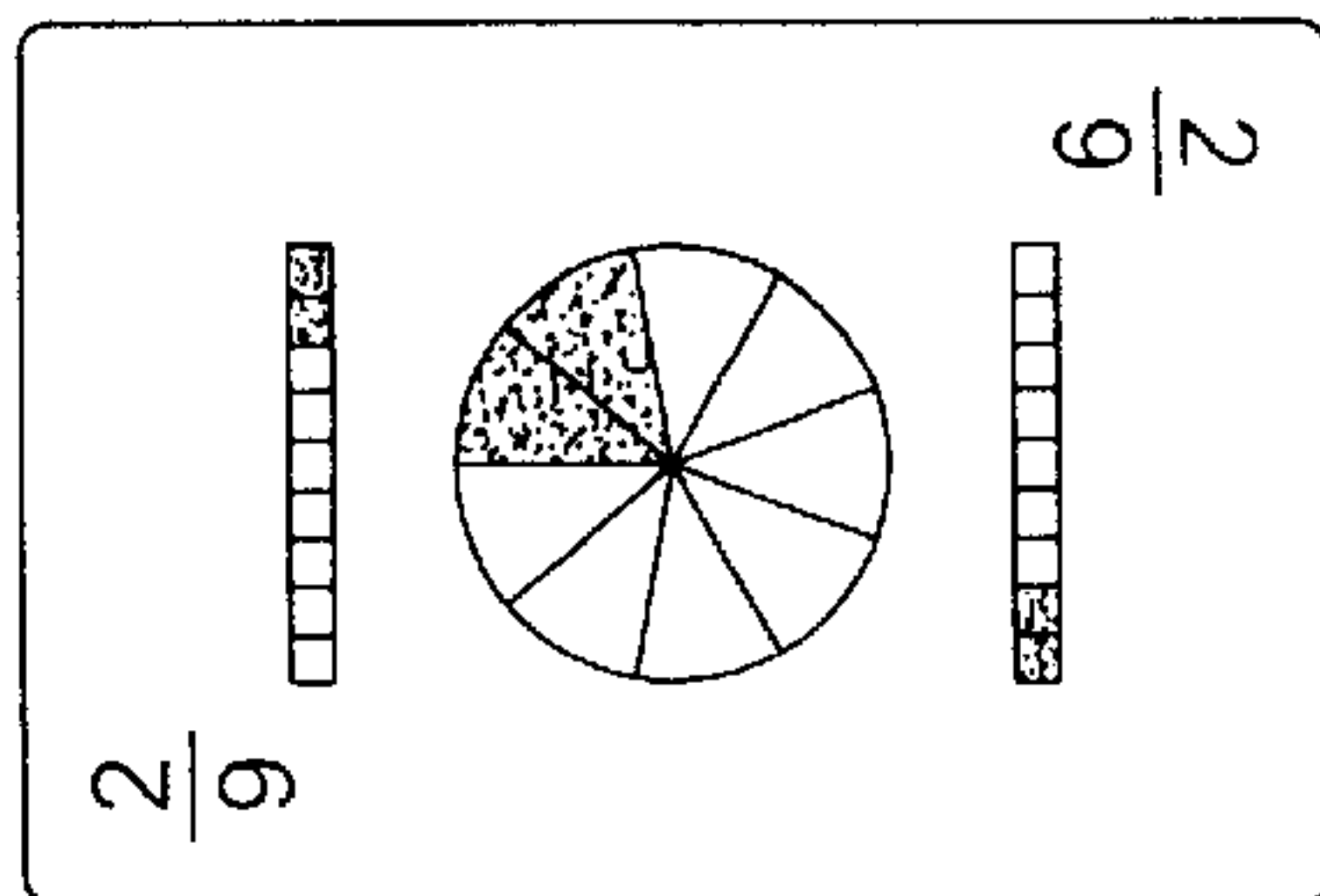

FIG. 30

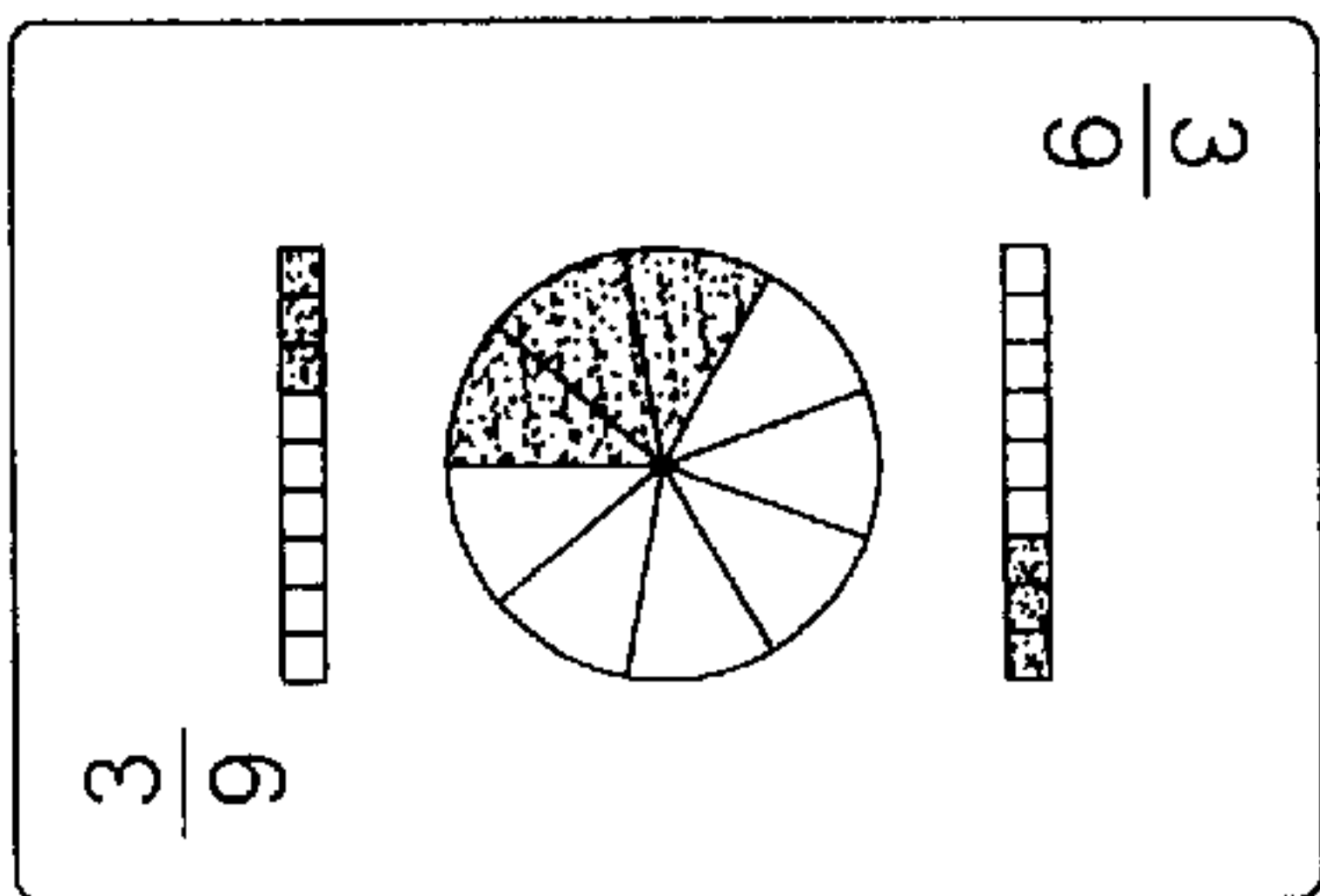

FIG. 31

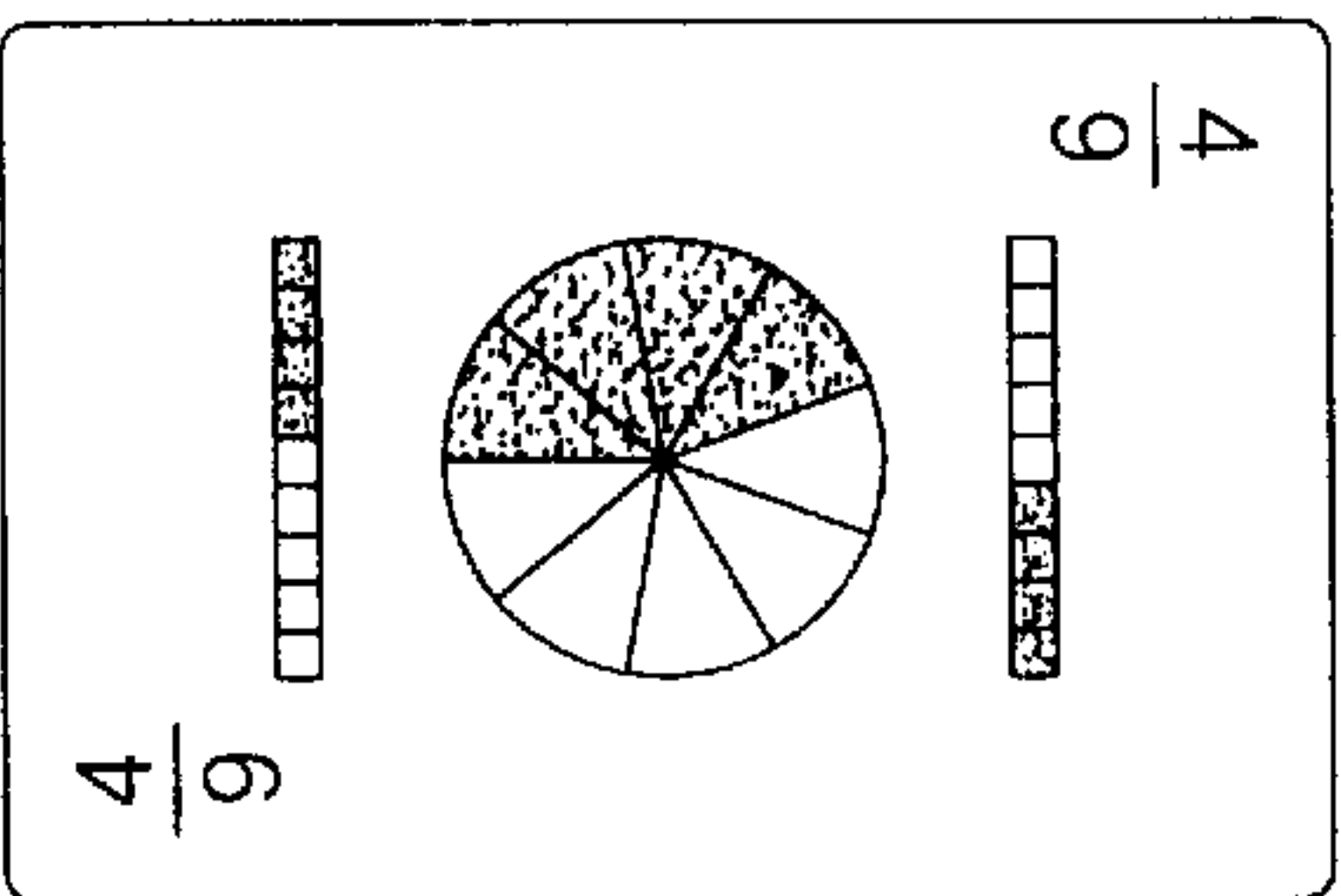

FIG. 32

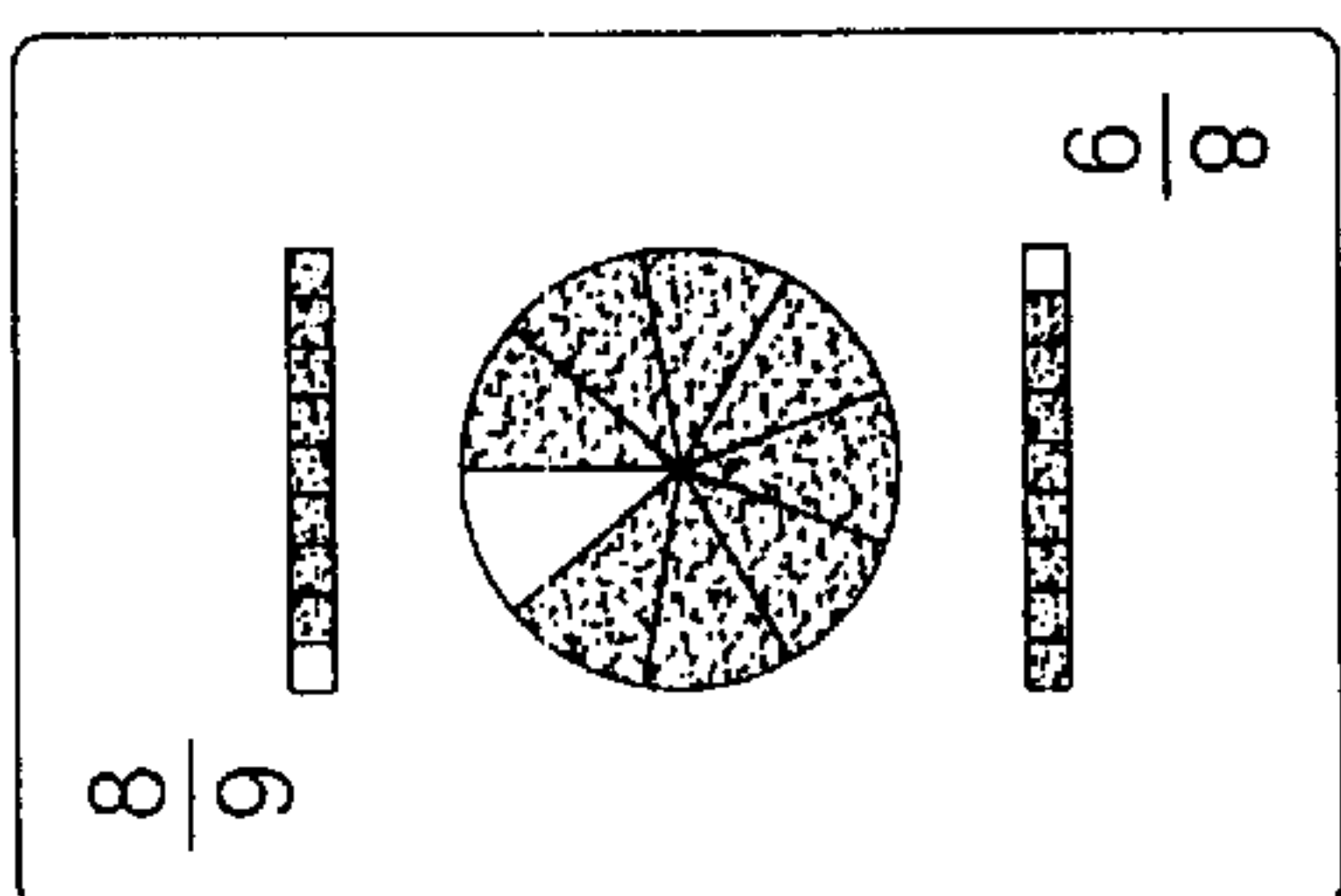

FIG. 36

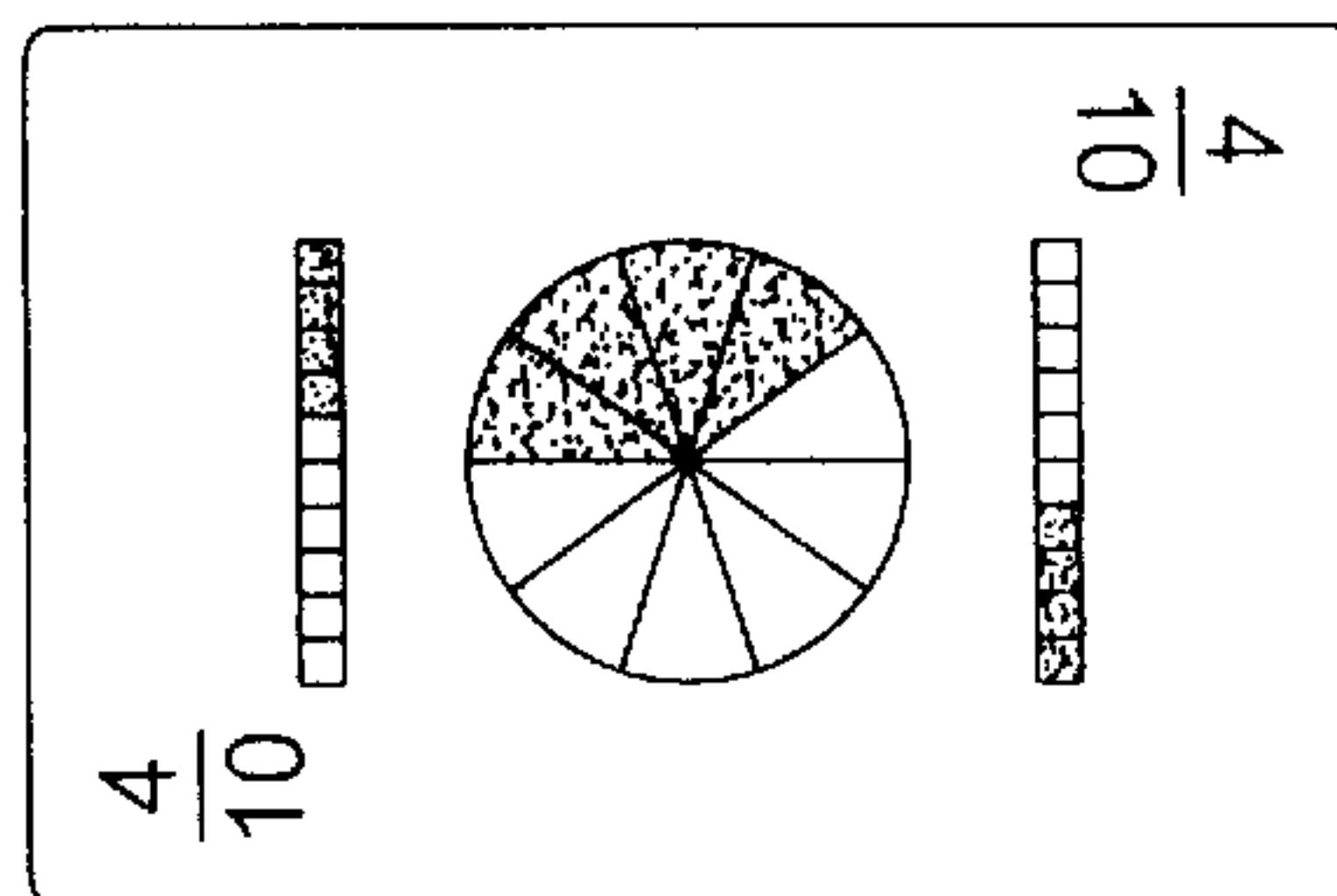

FIG. 40

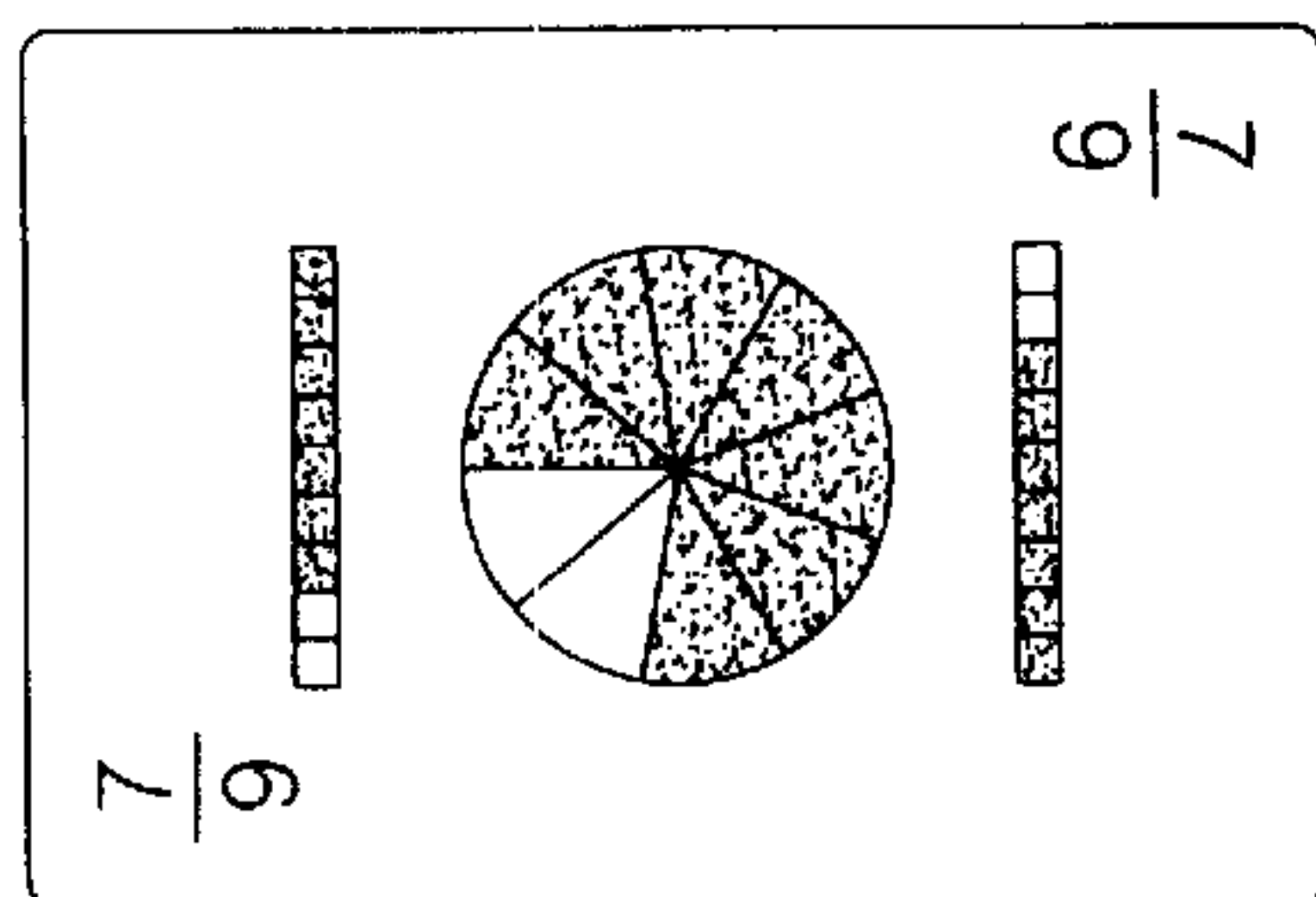

FIG. 35

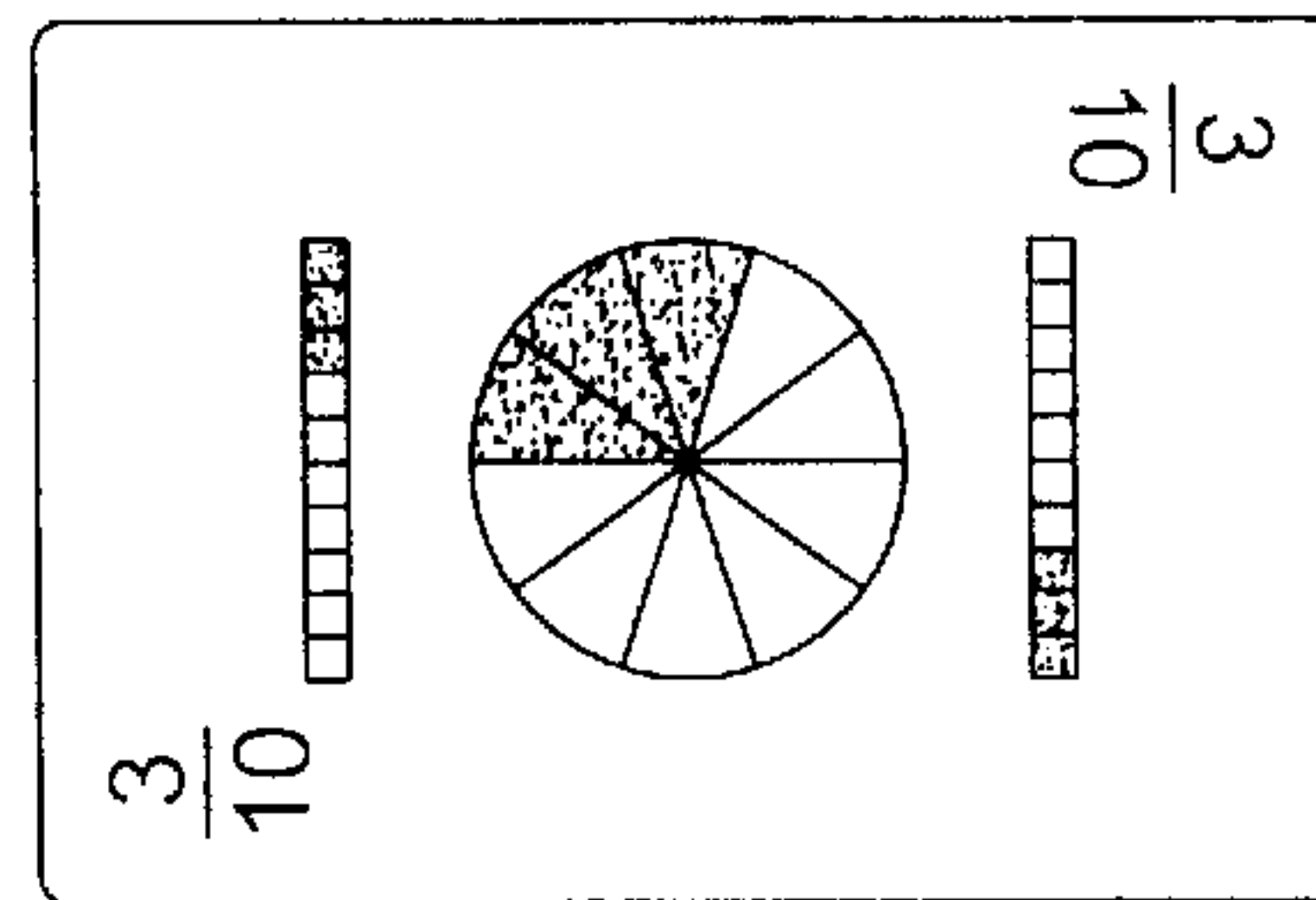

FIG. 39

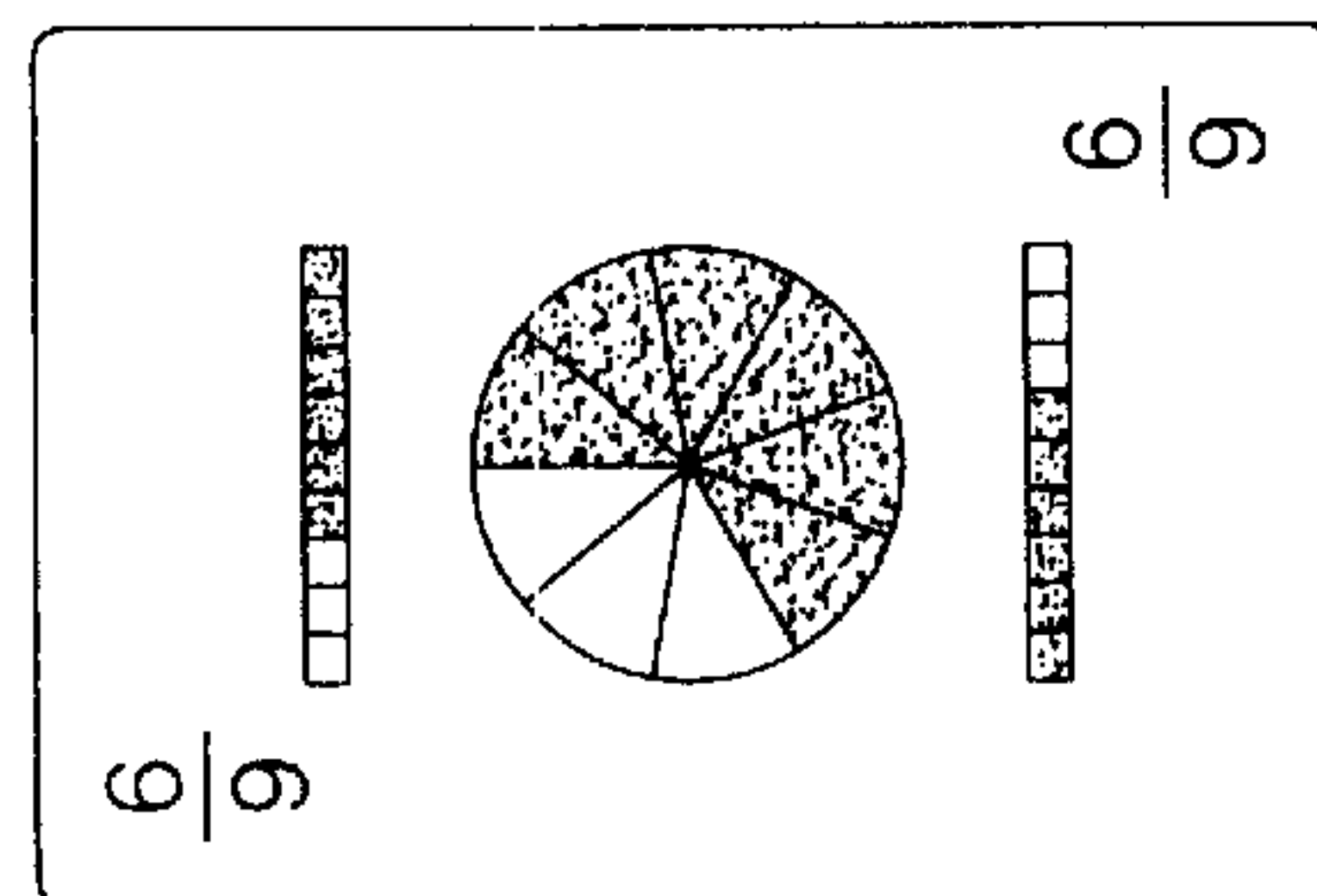

FIG. 34

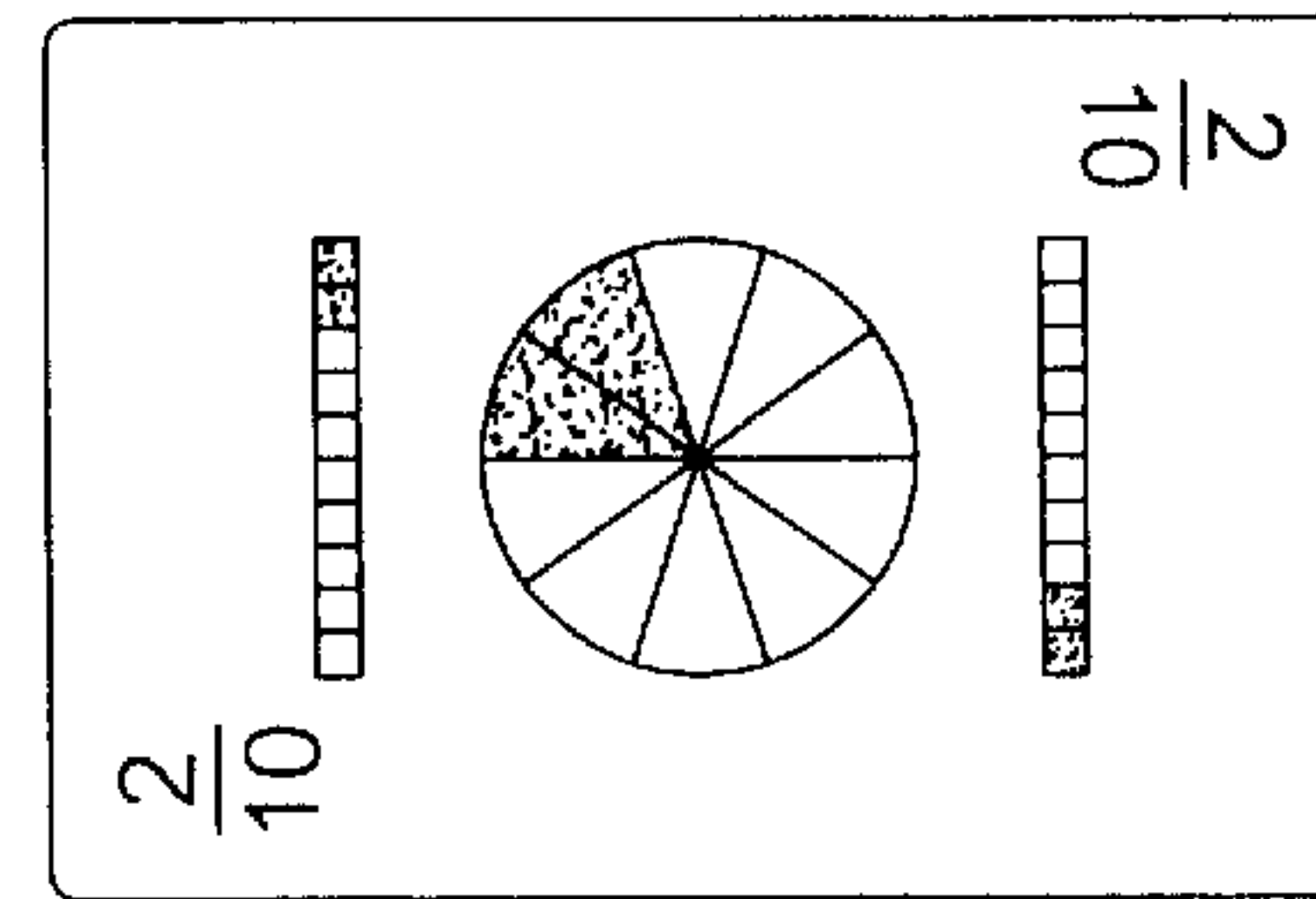

FIG. 38

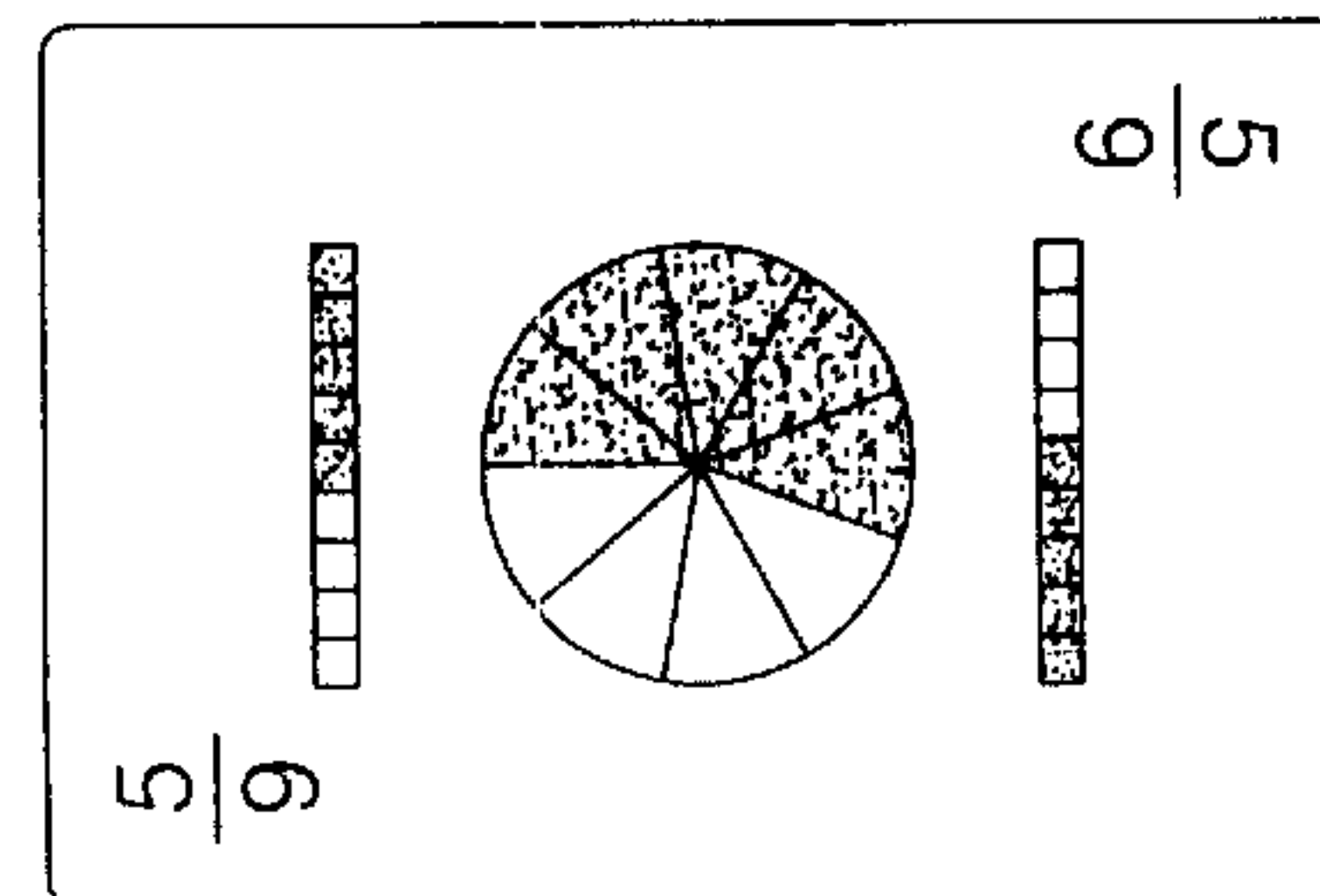

FIG. 33

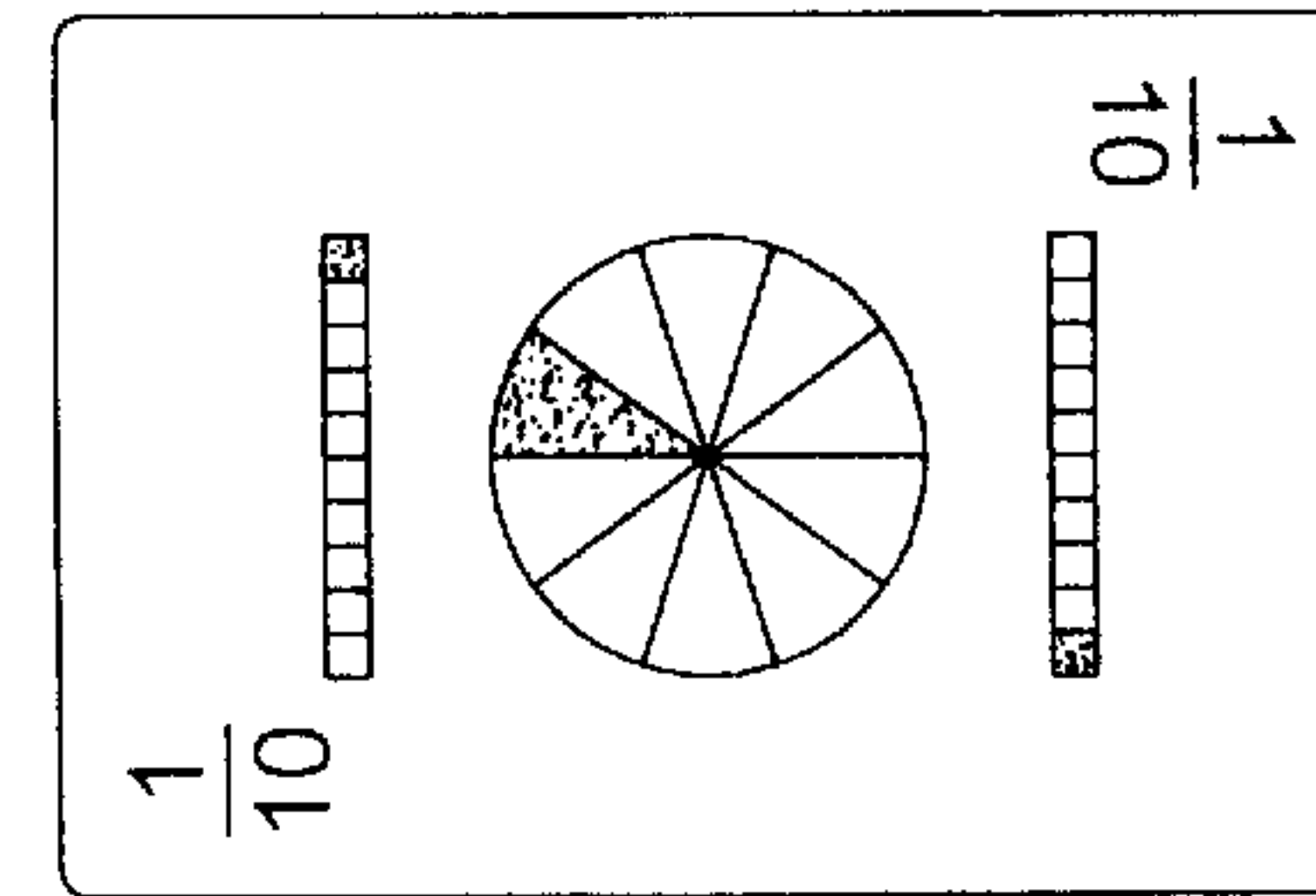

FIG. 37

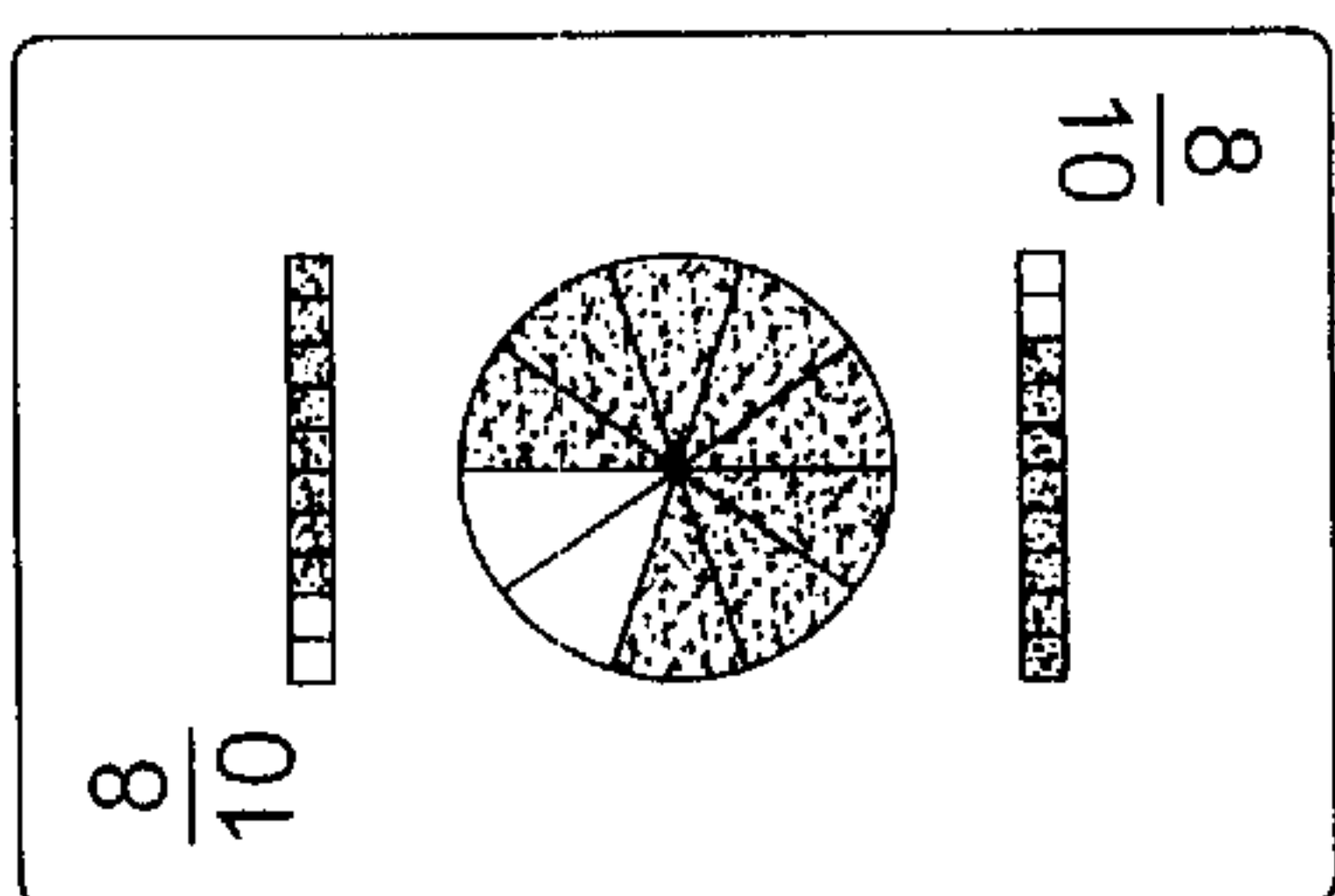

FIG. 44

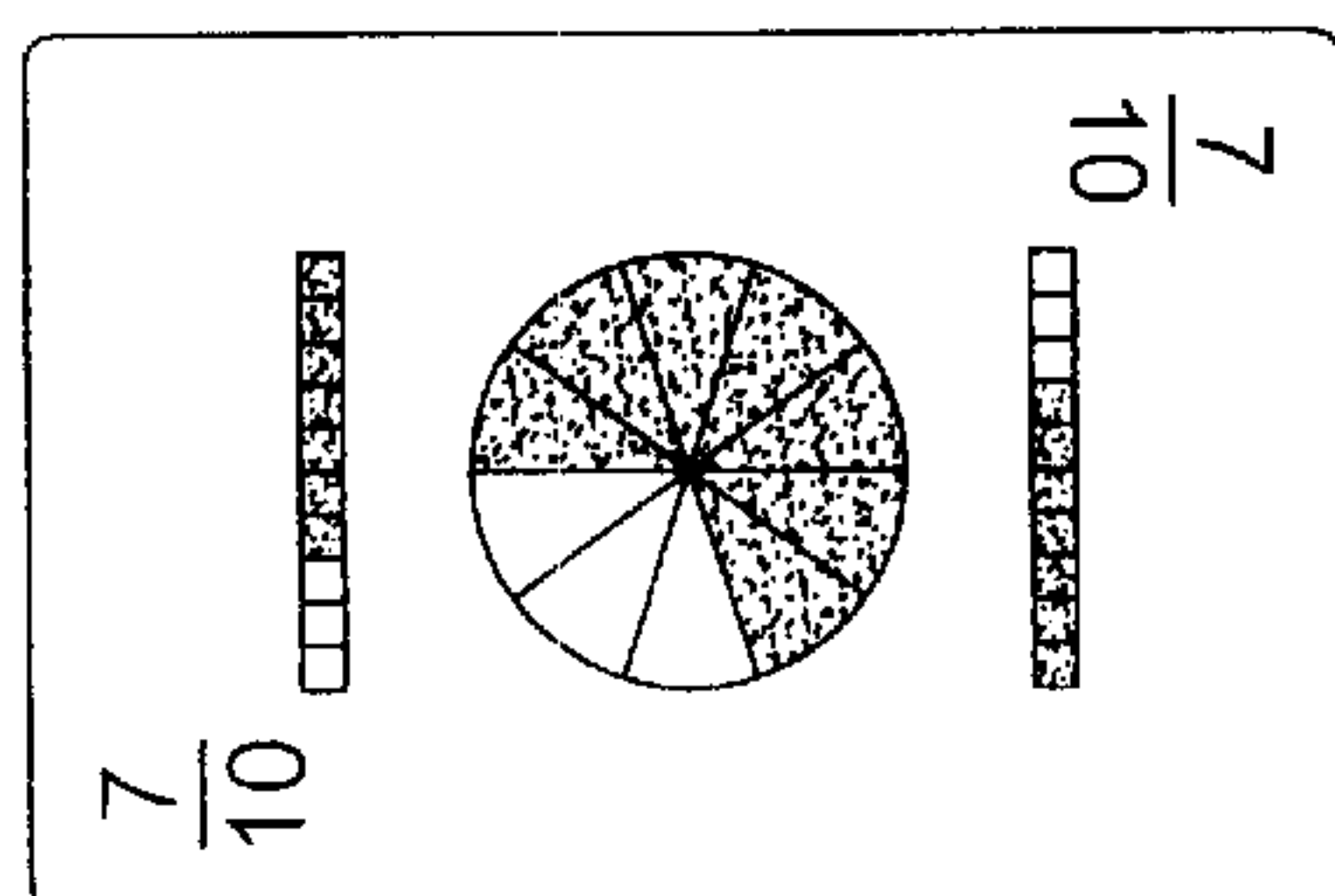

FIG. 43

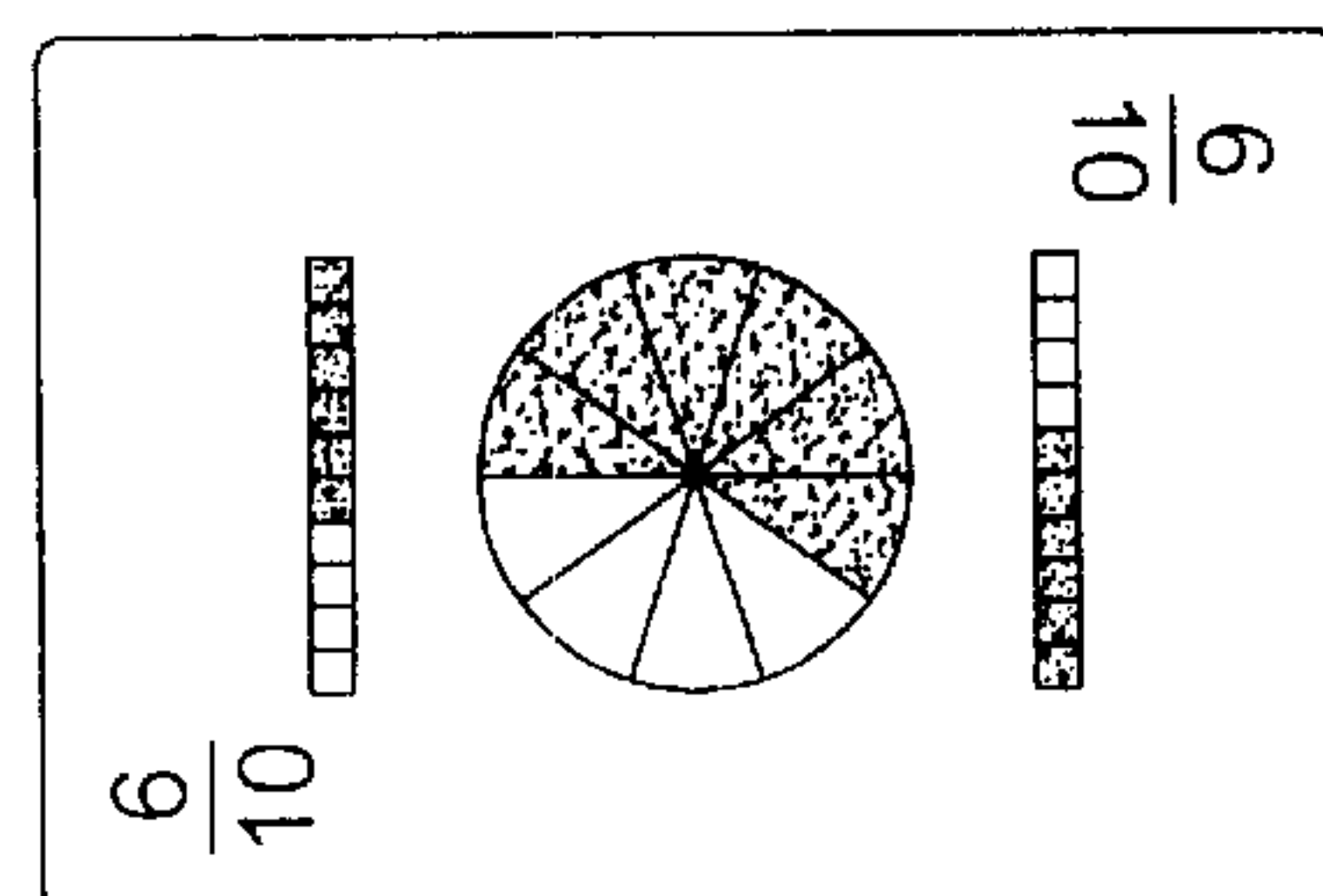

FIG. 42

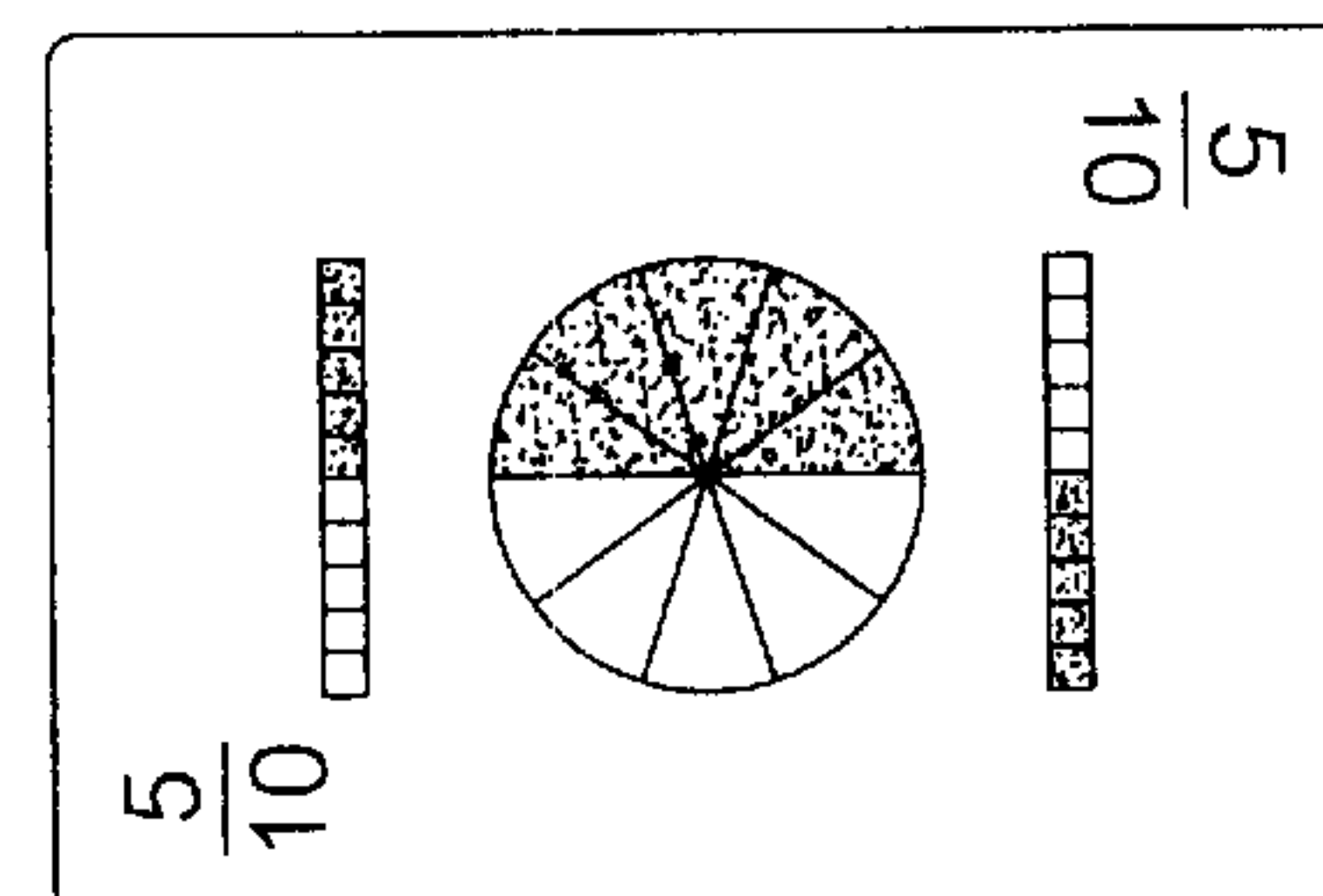

FIG. 41

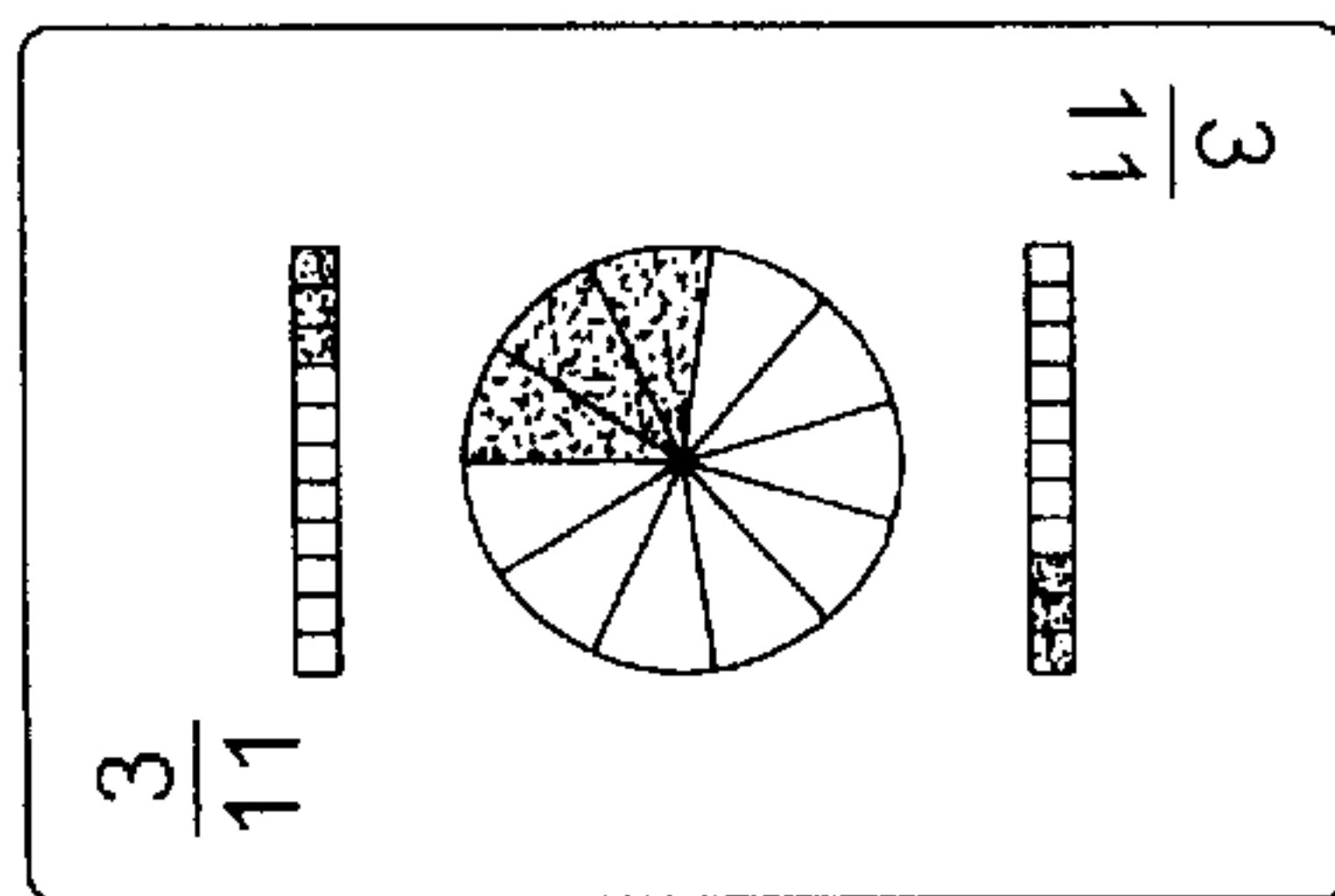

FIG. 48

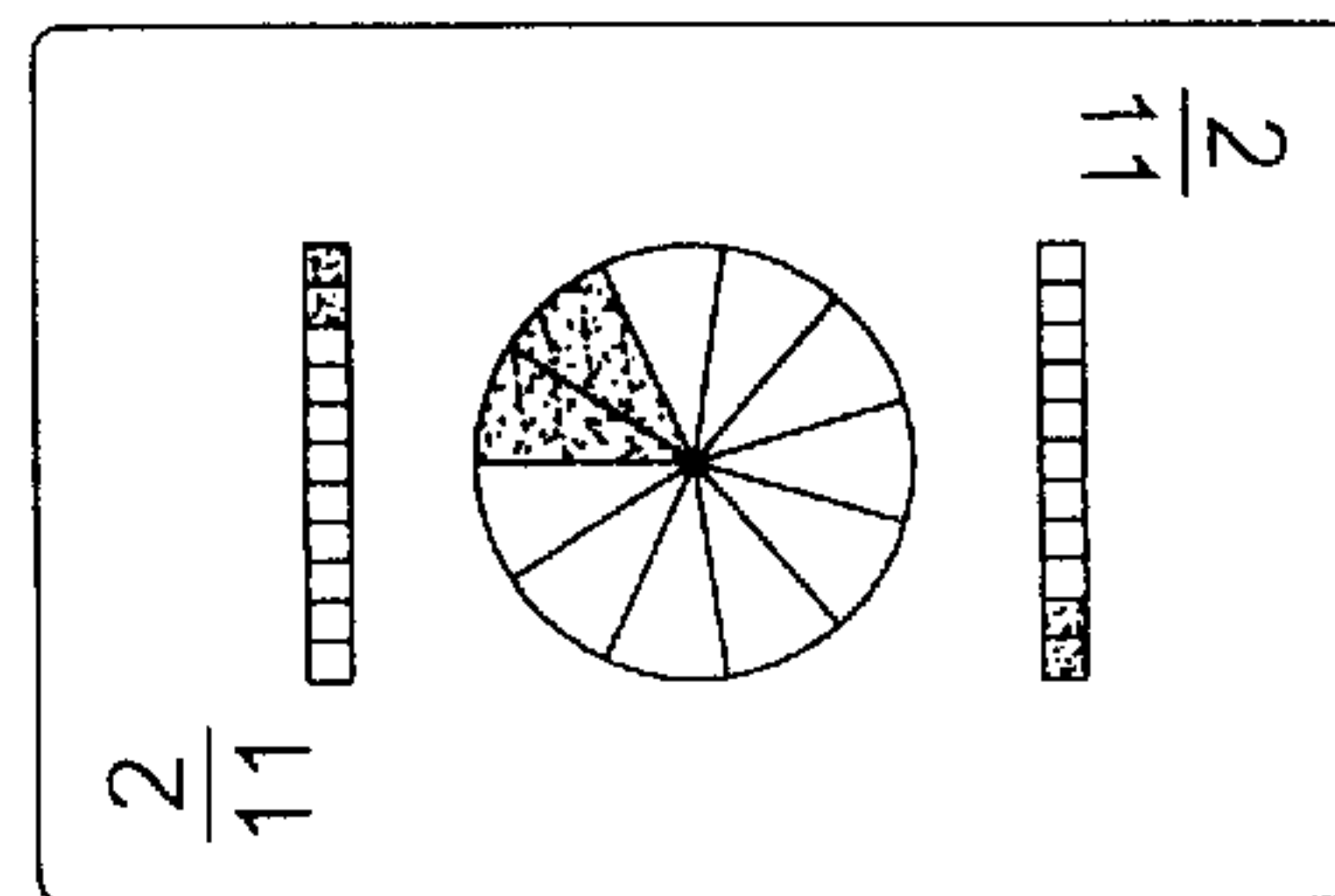

FIG. 47

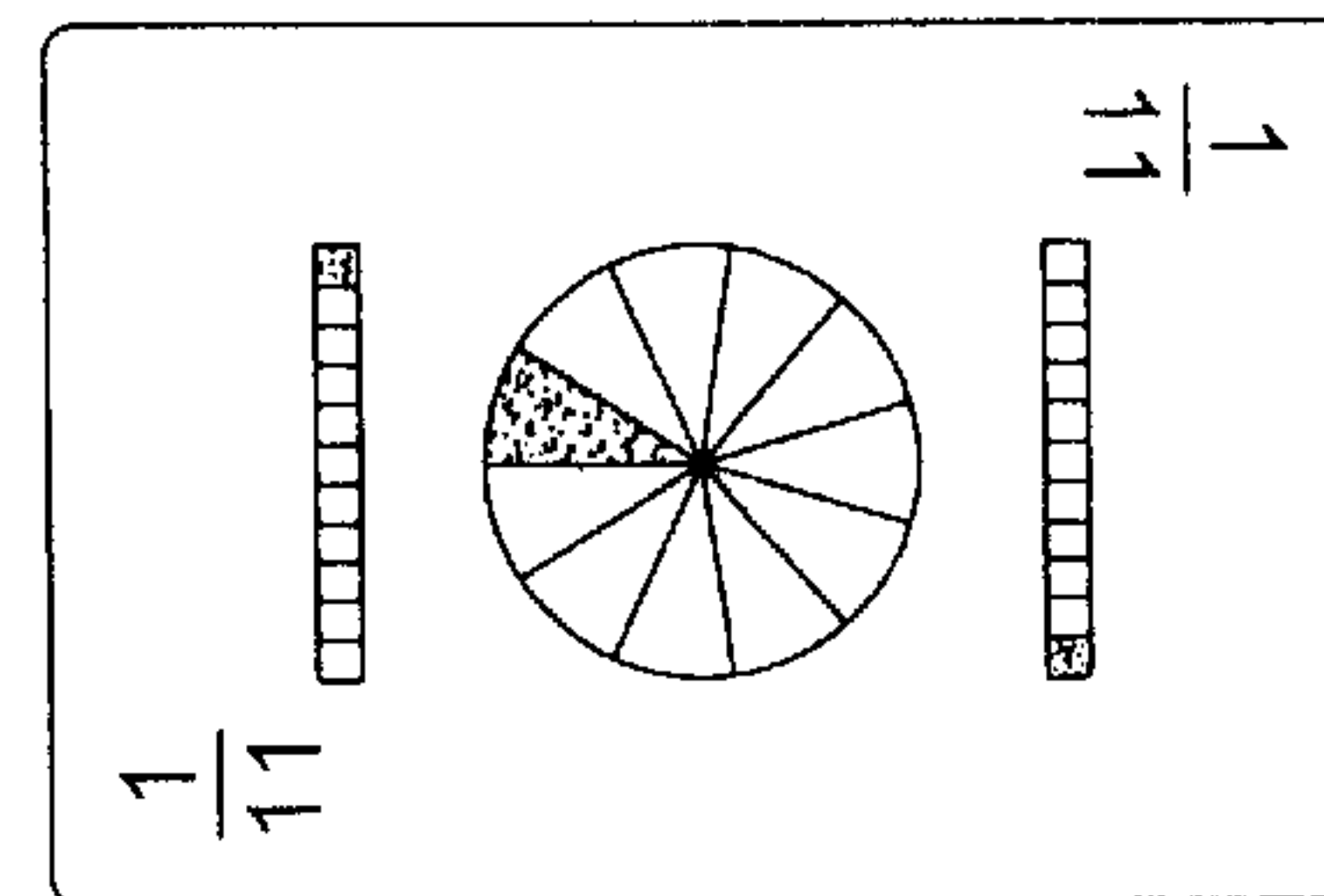

FIG. 46

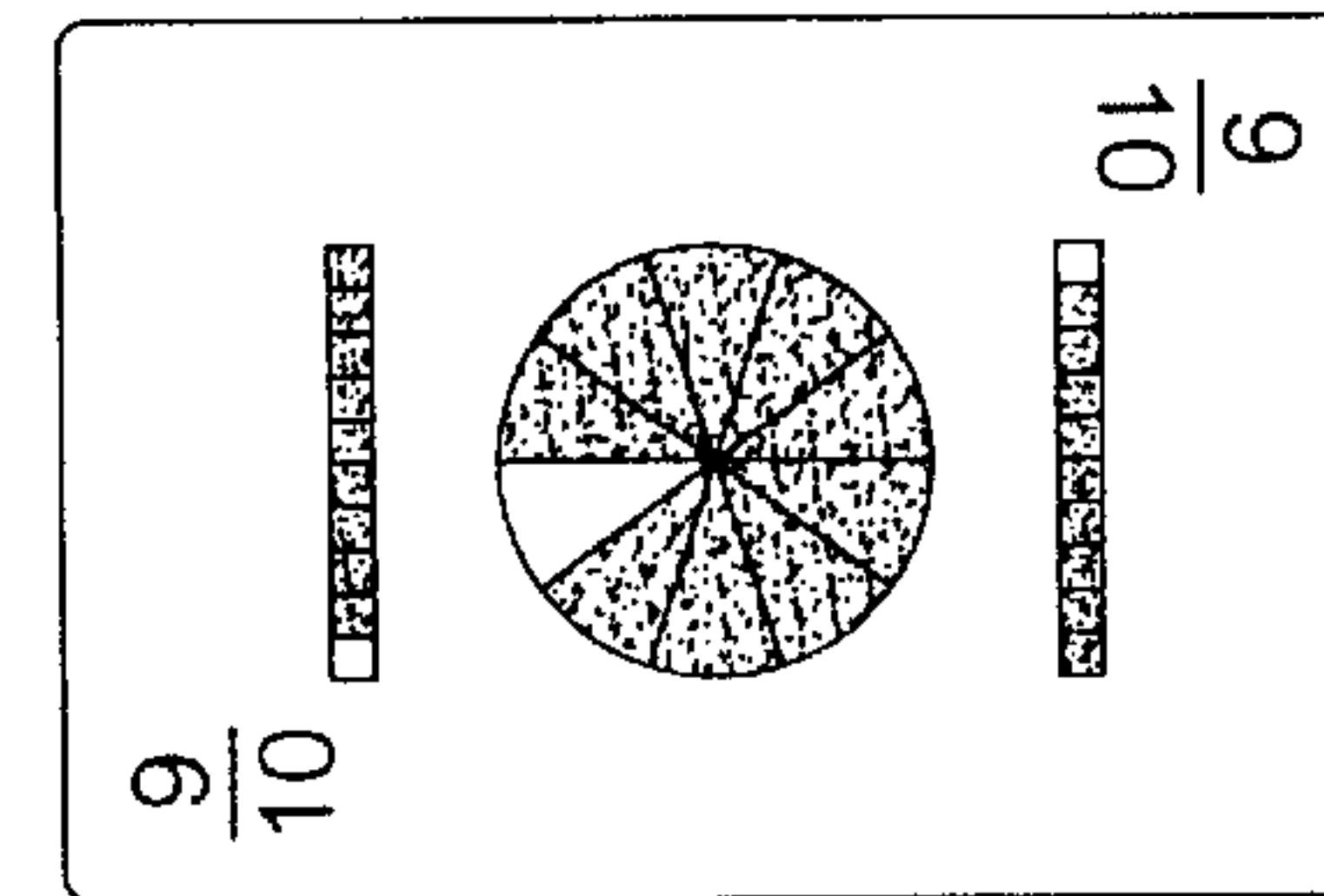

FIG. 45



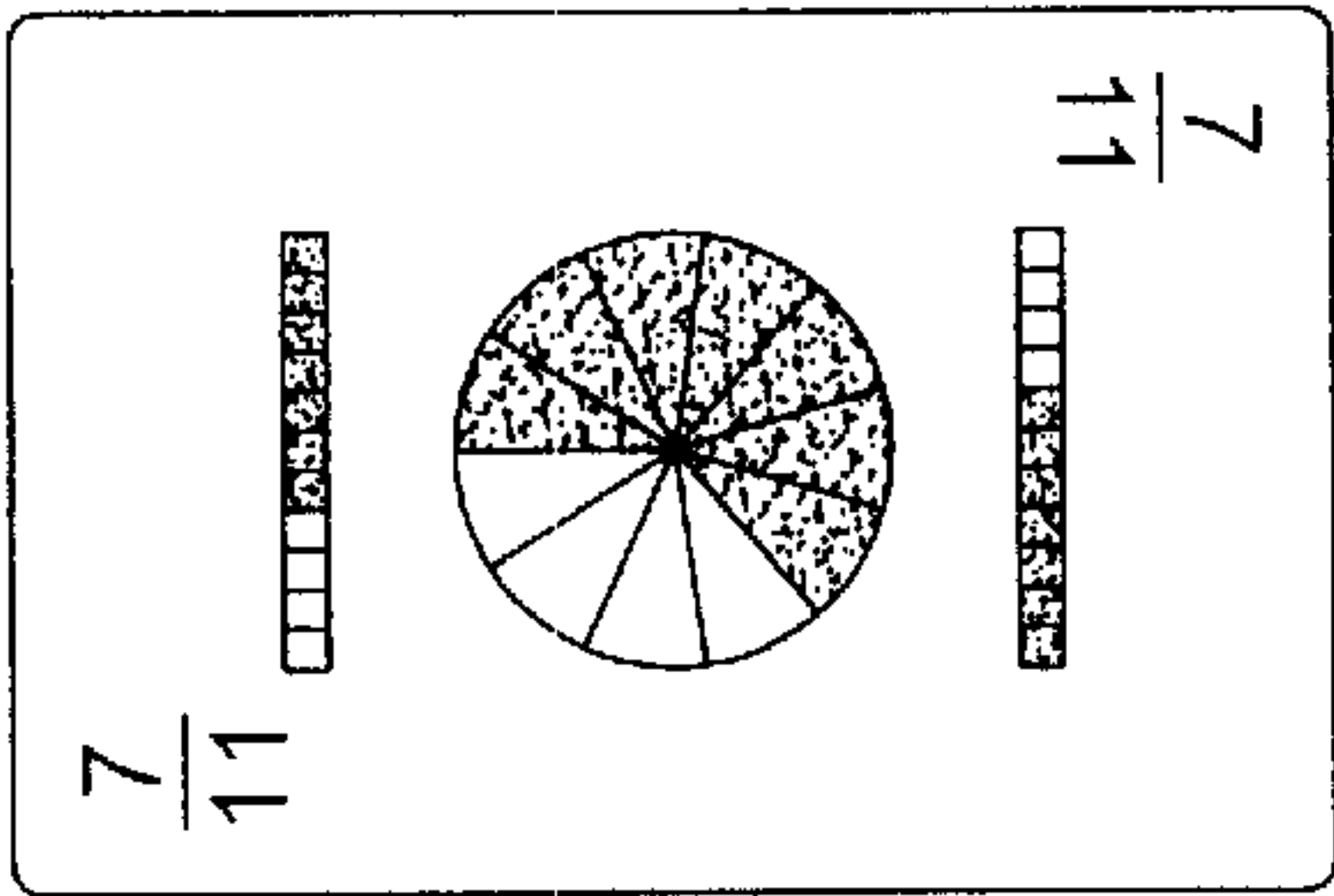

FIG. 52

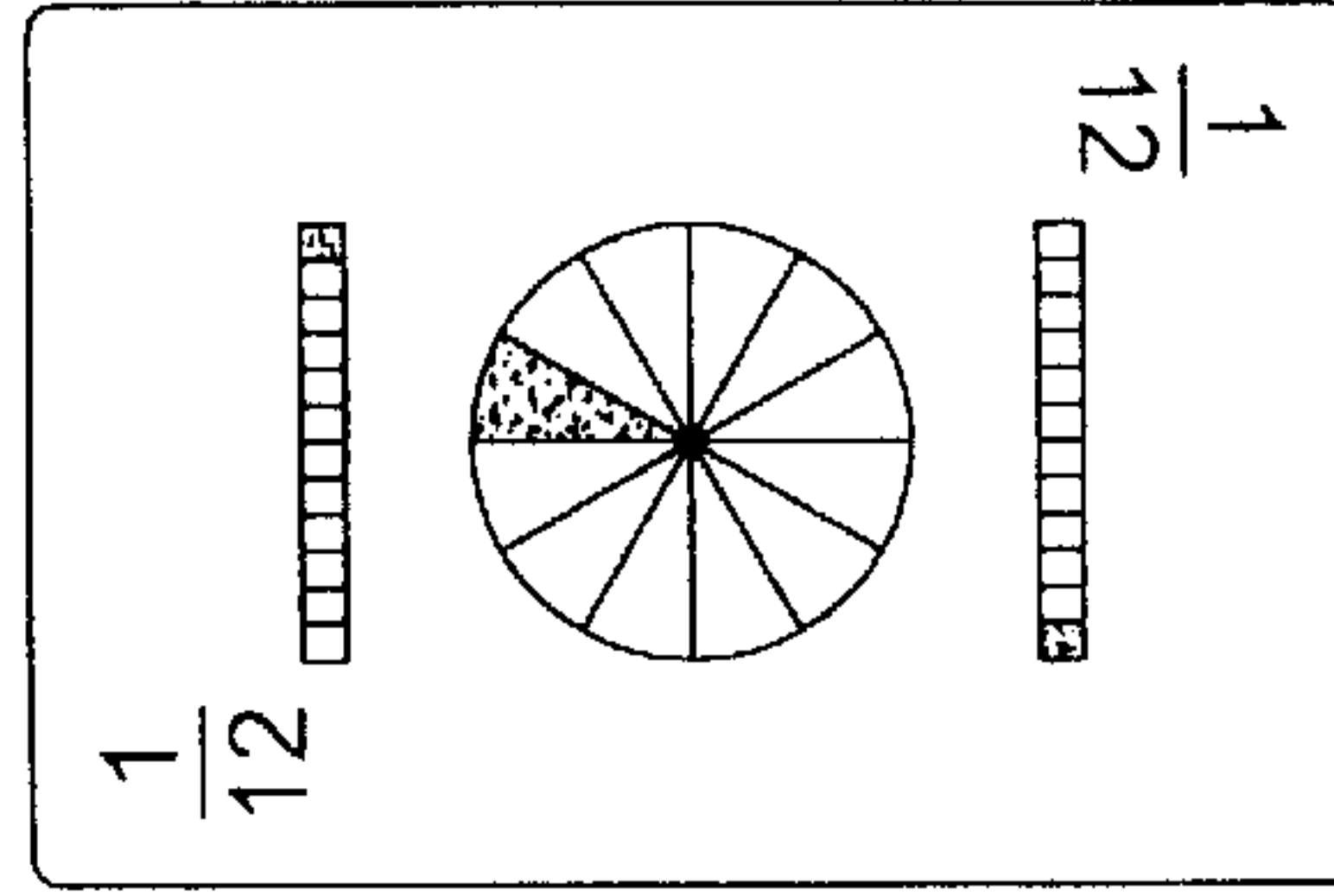

FIG. 56

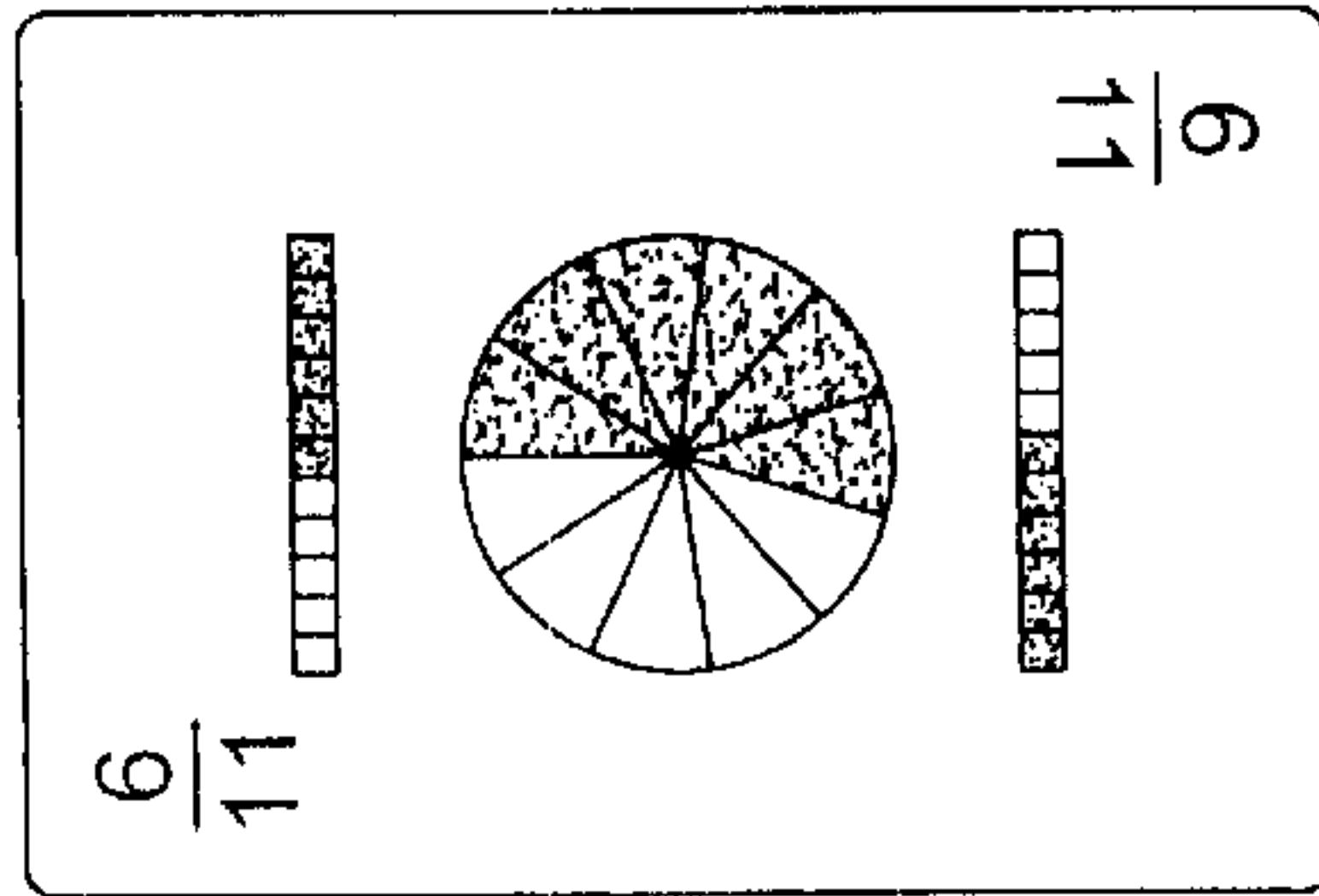

FIG. 51

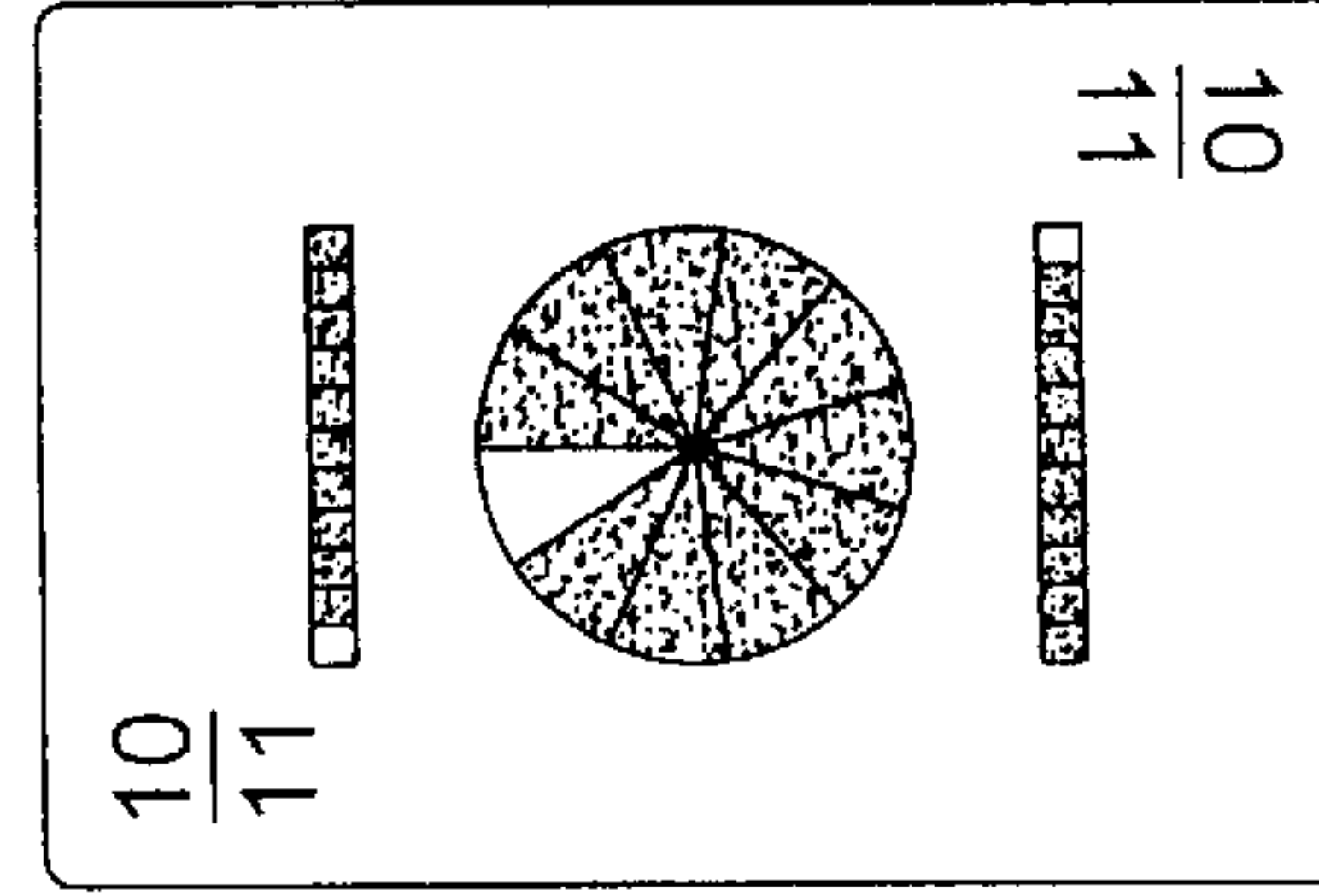

FIG. 55

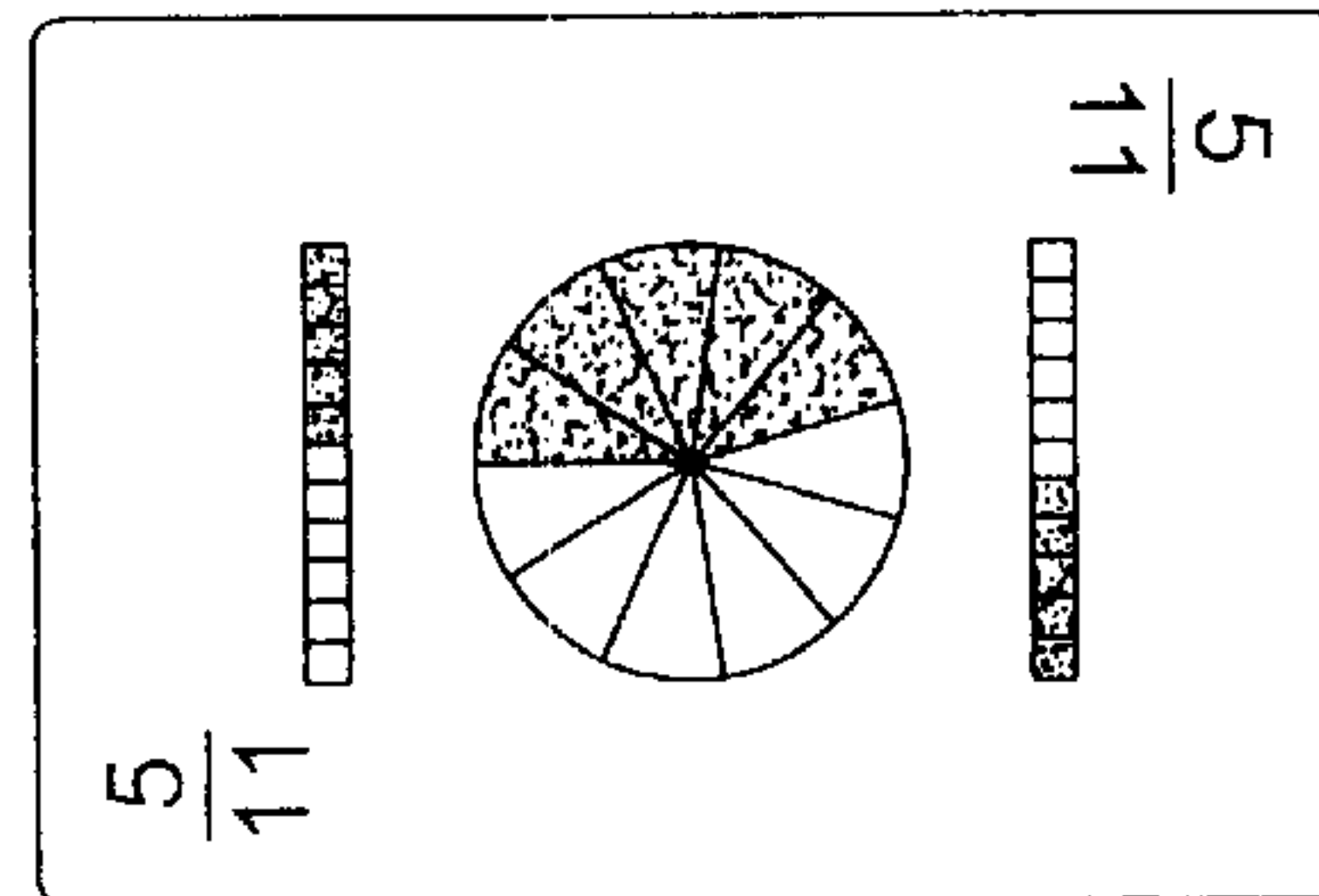

FIG. 50

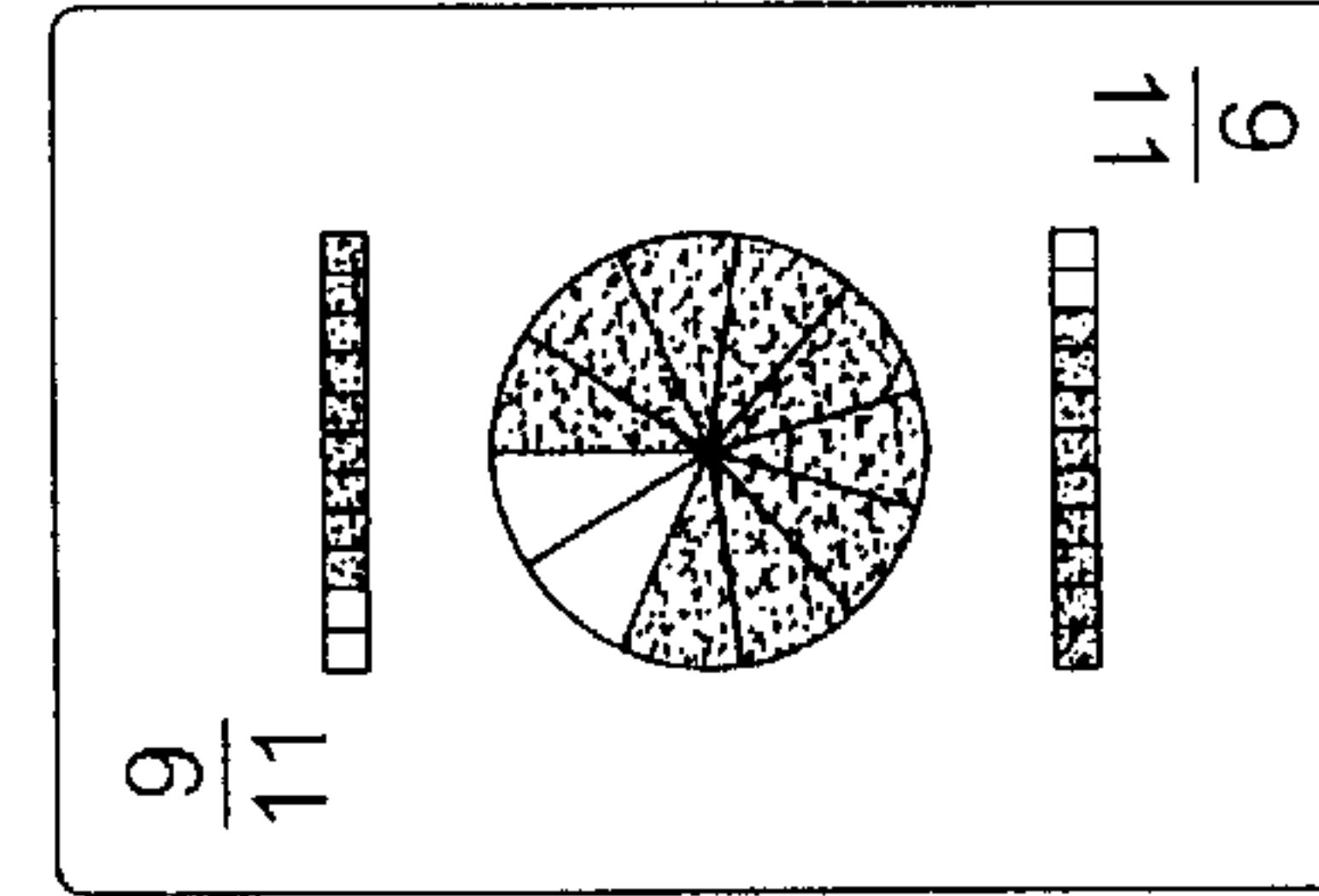

FIG. 54

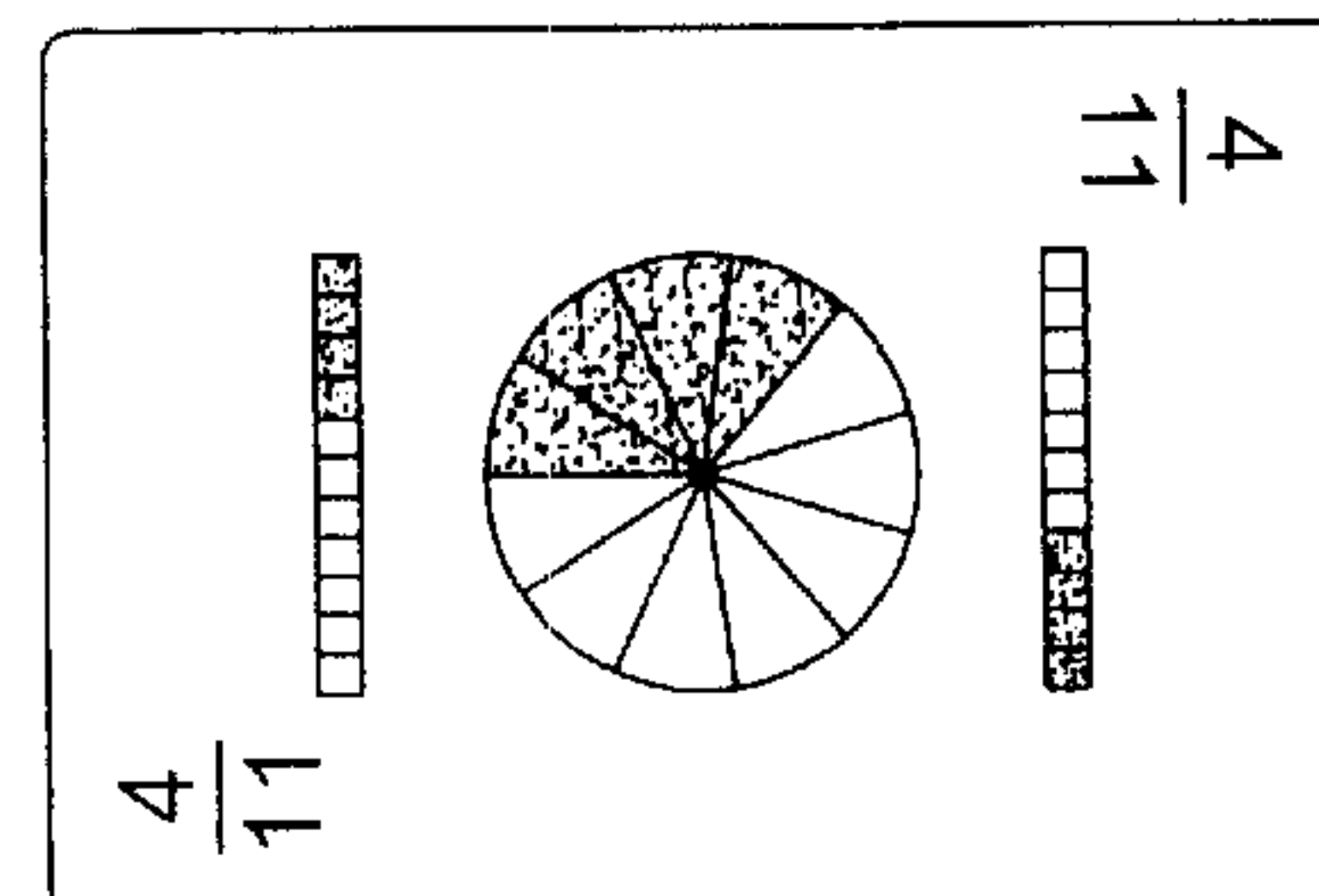

FIG. 49

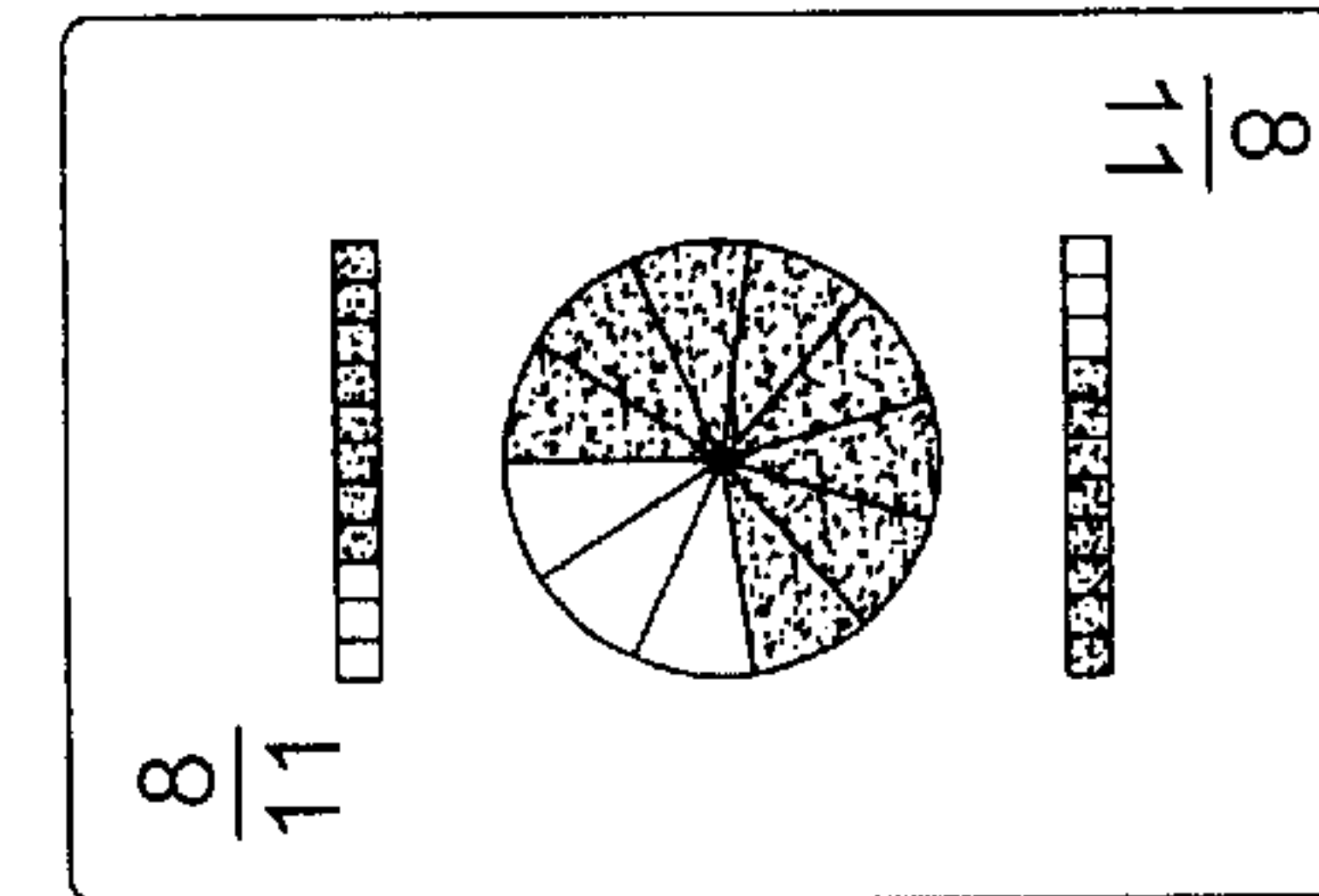

FIG. 53

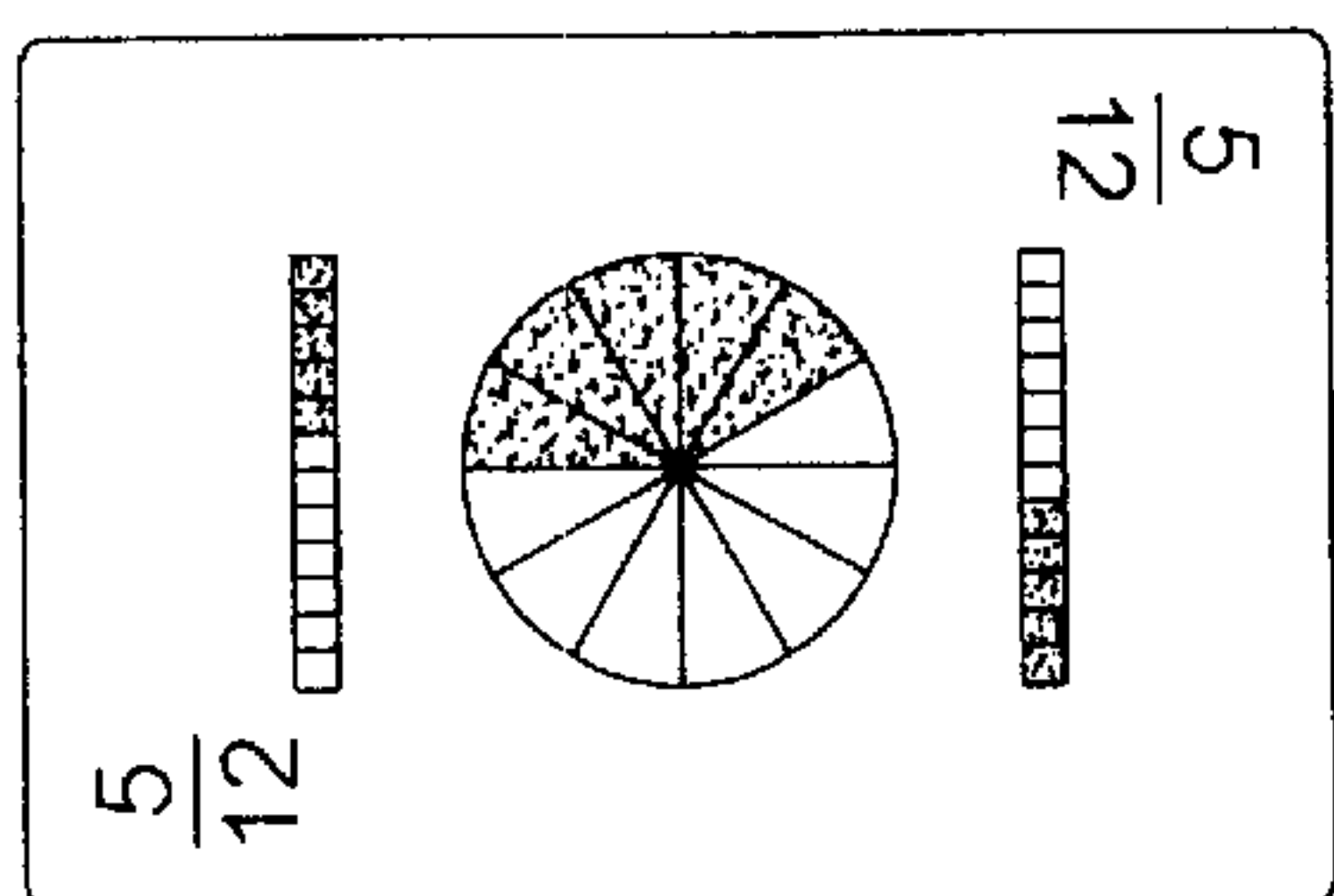

FIG. 57

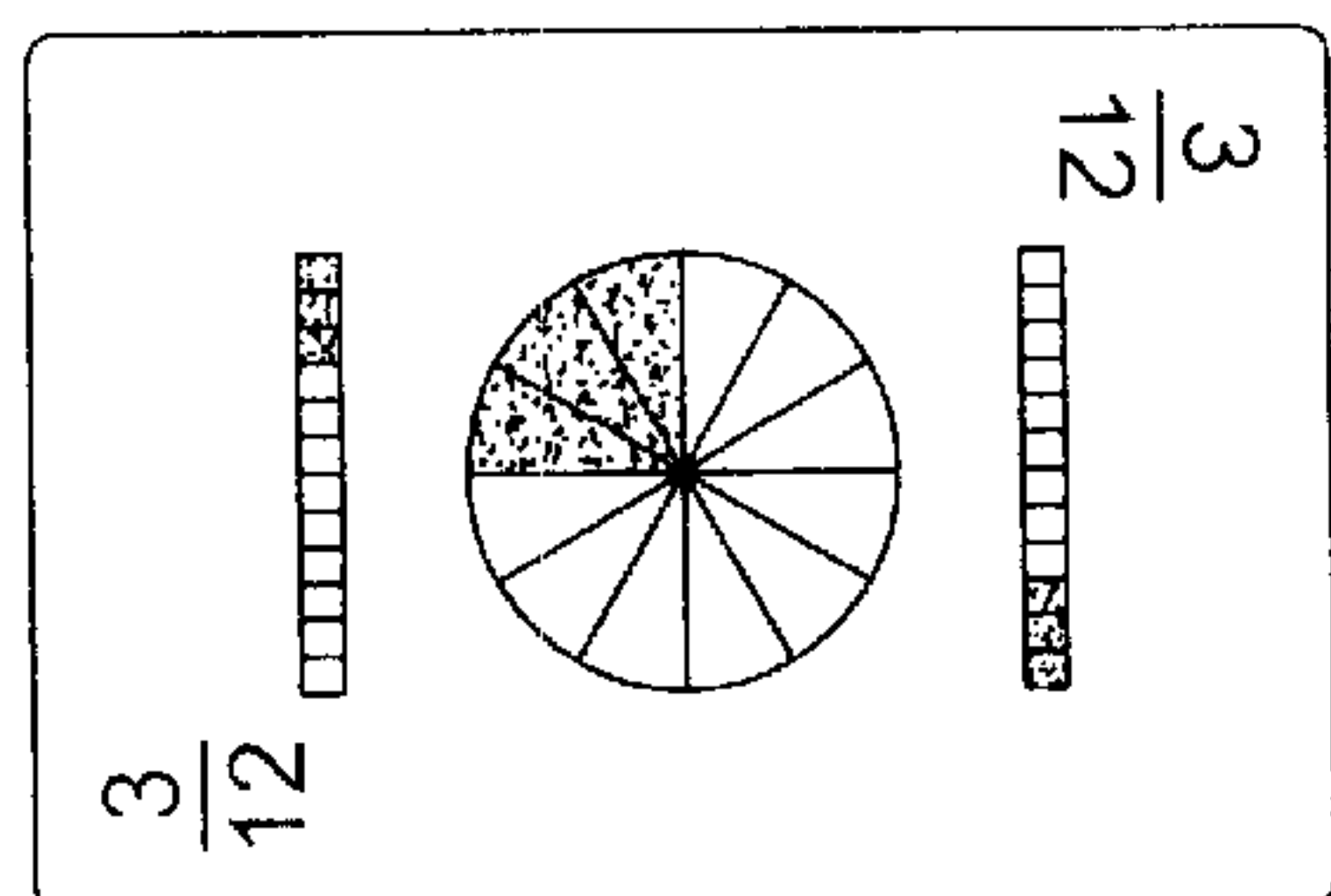

FIG. 58

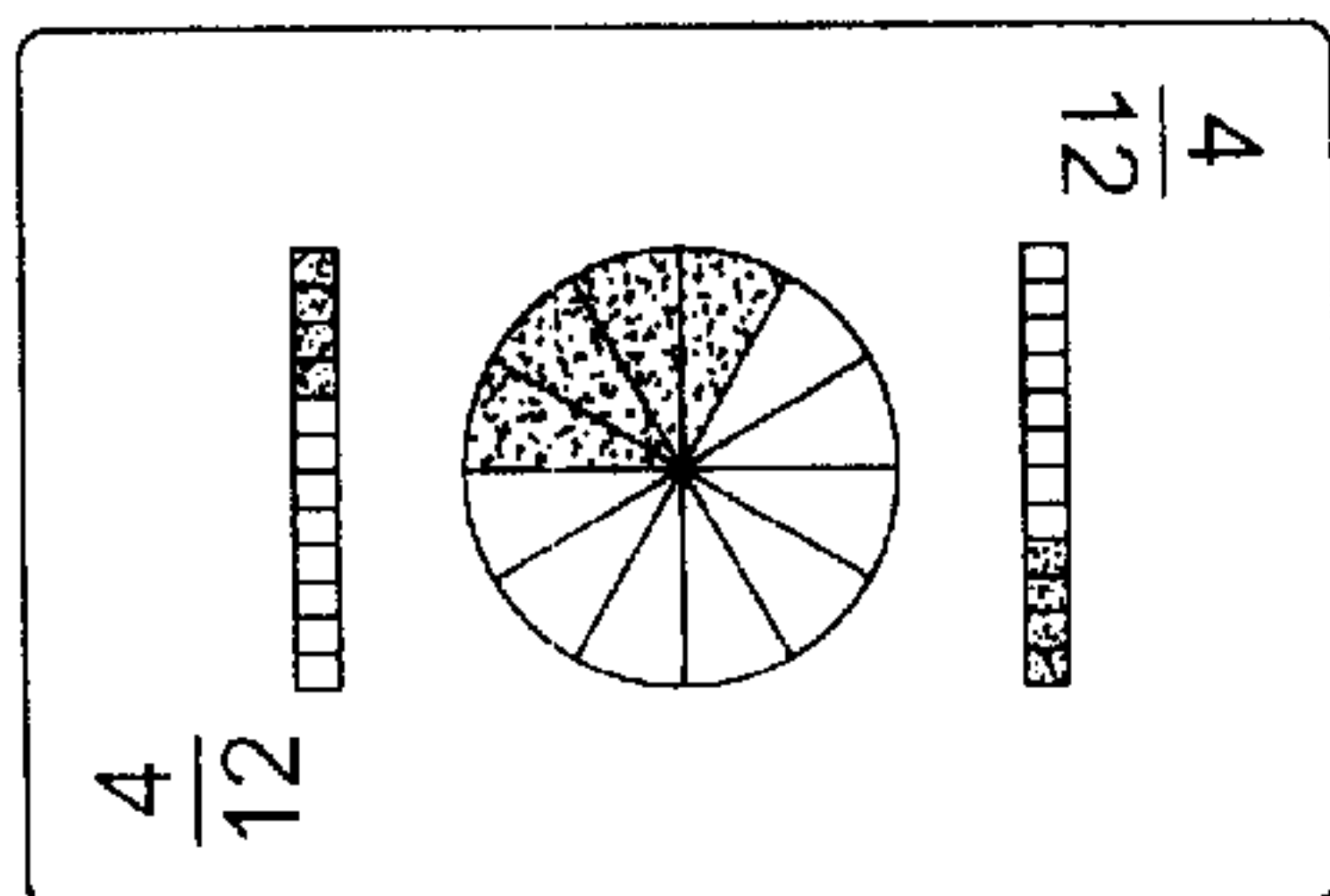

FIG. 59

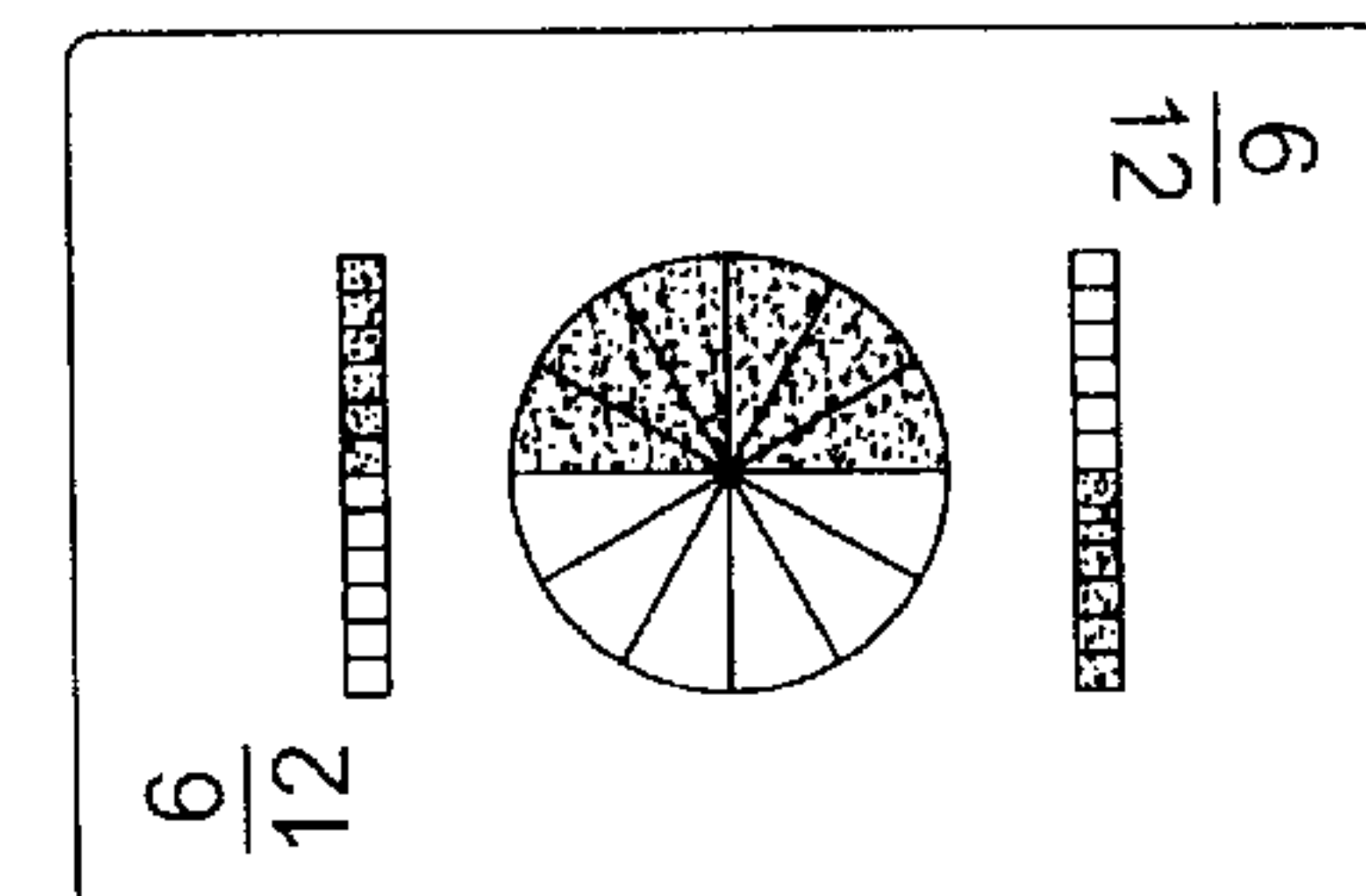

FIG. 60

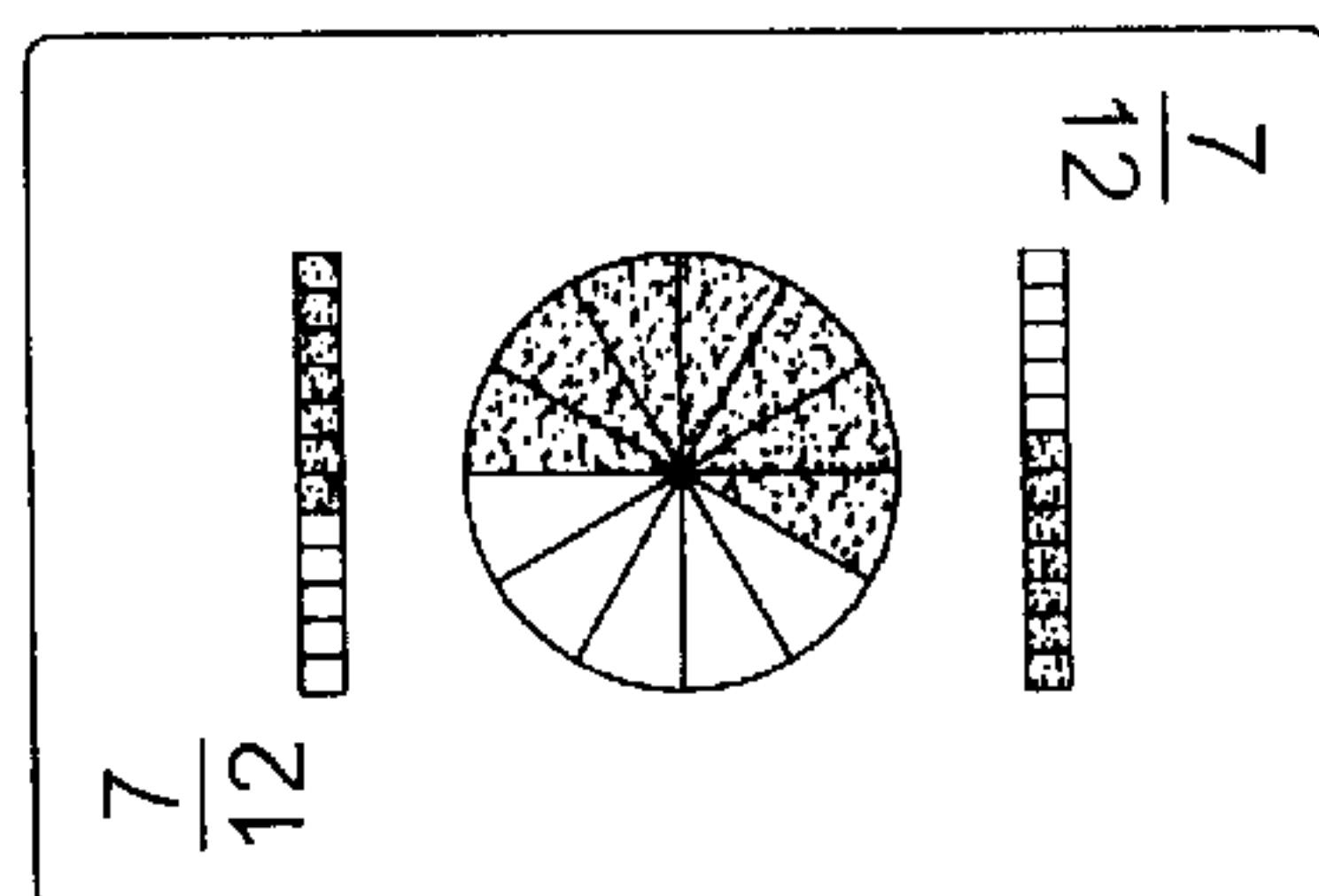

FIG. 61

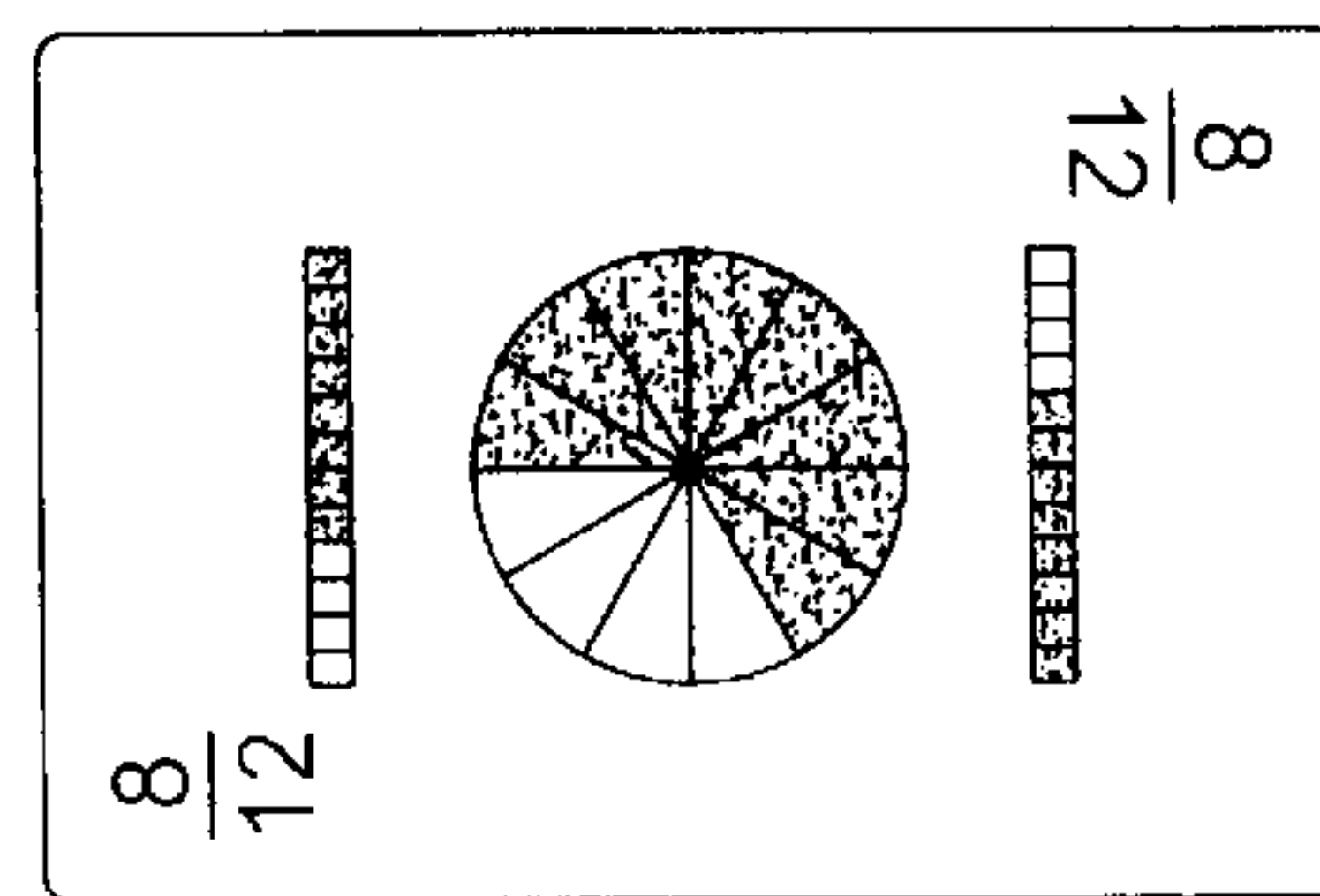

FIG. 62

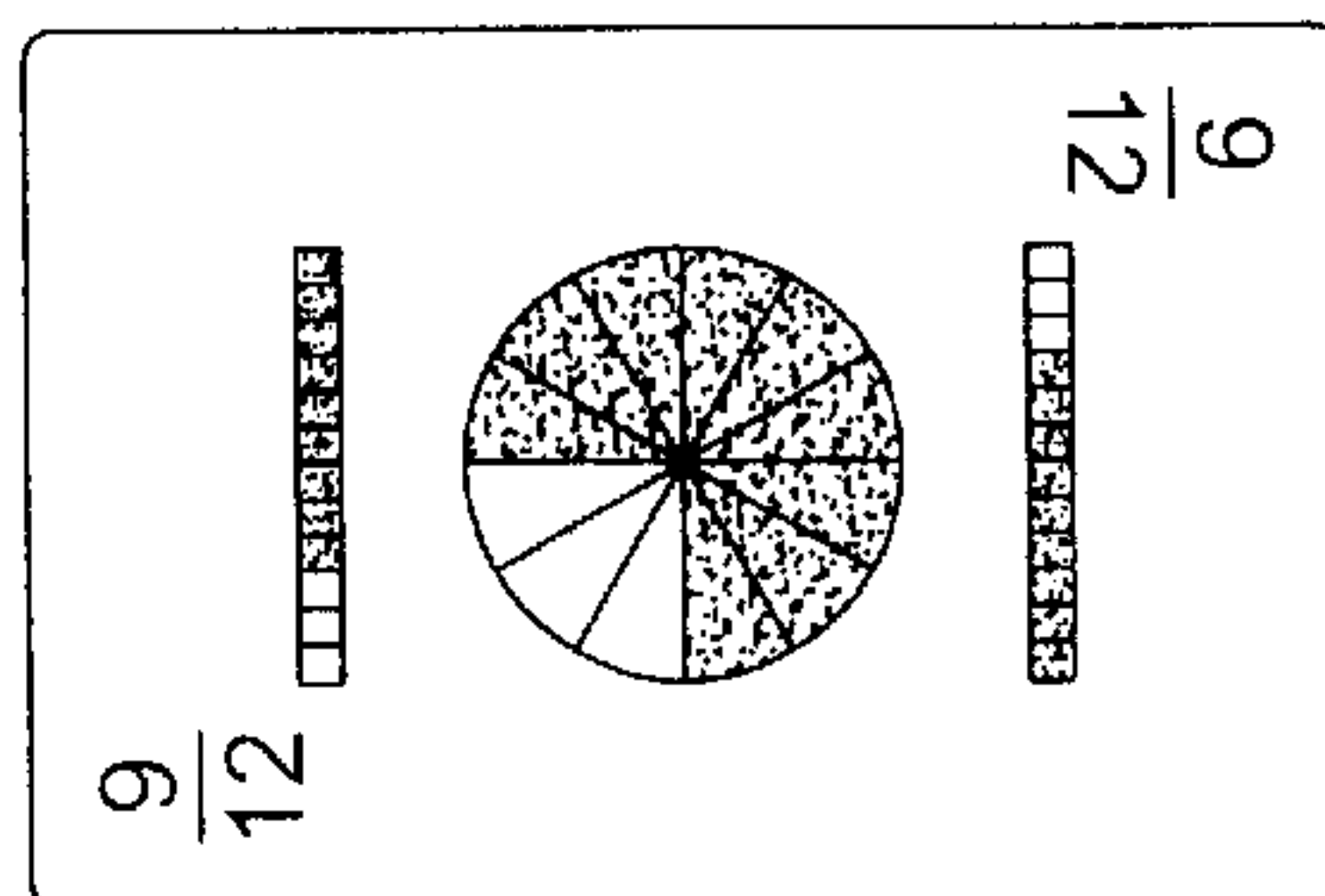

FIG. 63

FIG. 64

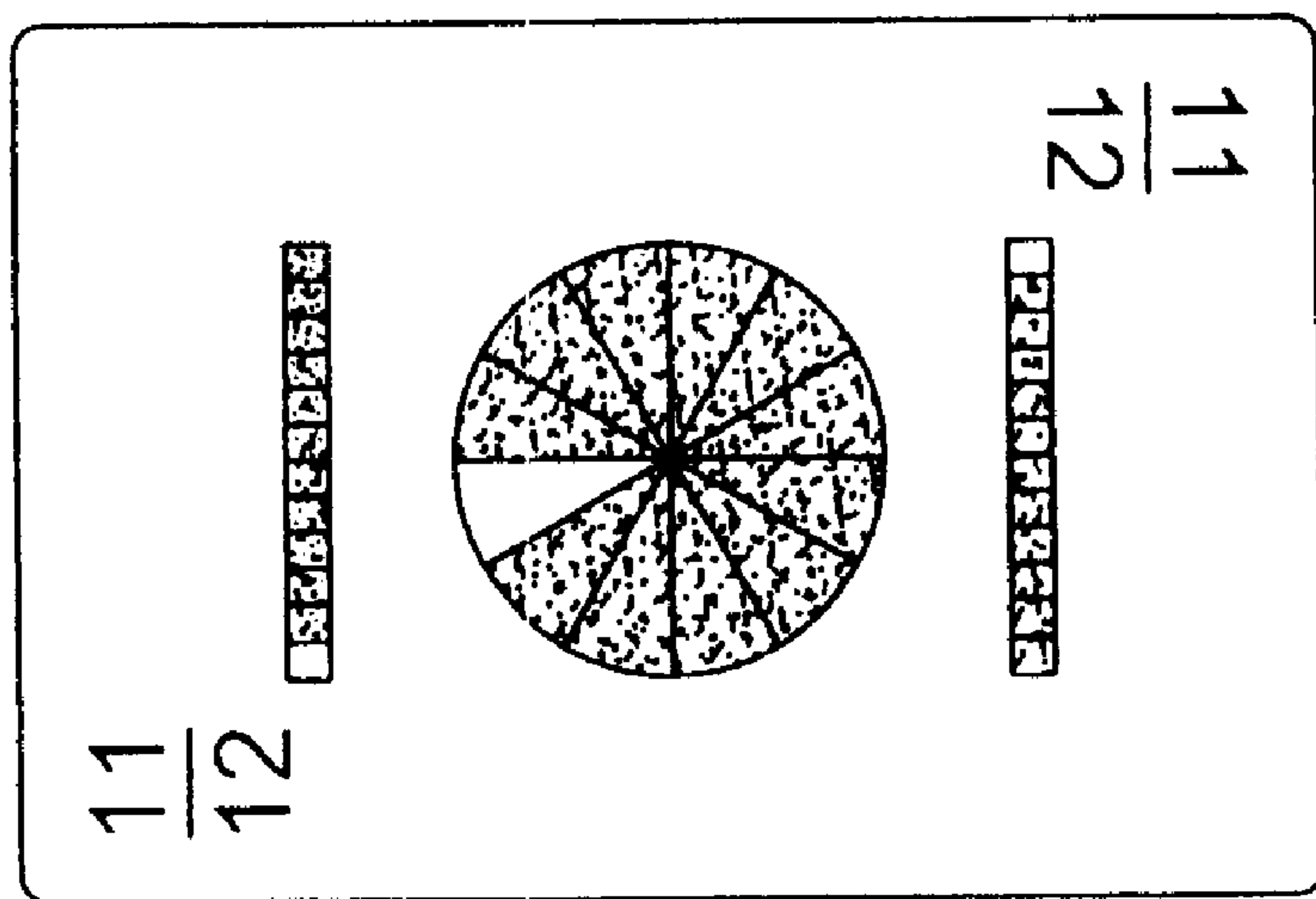

FIG. 66

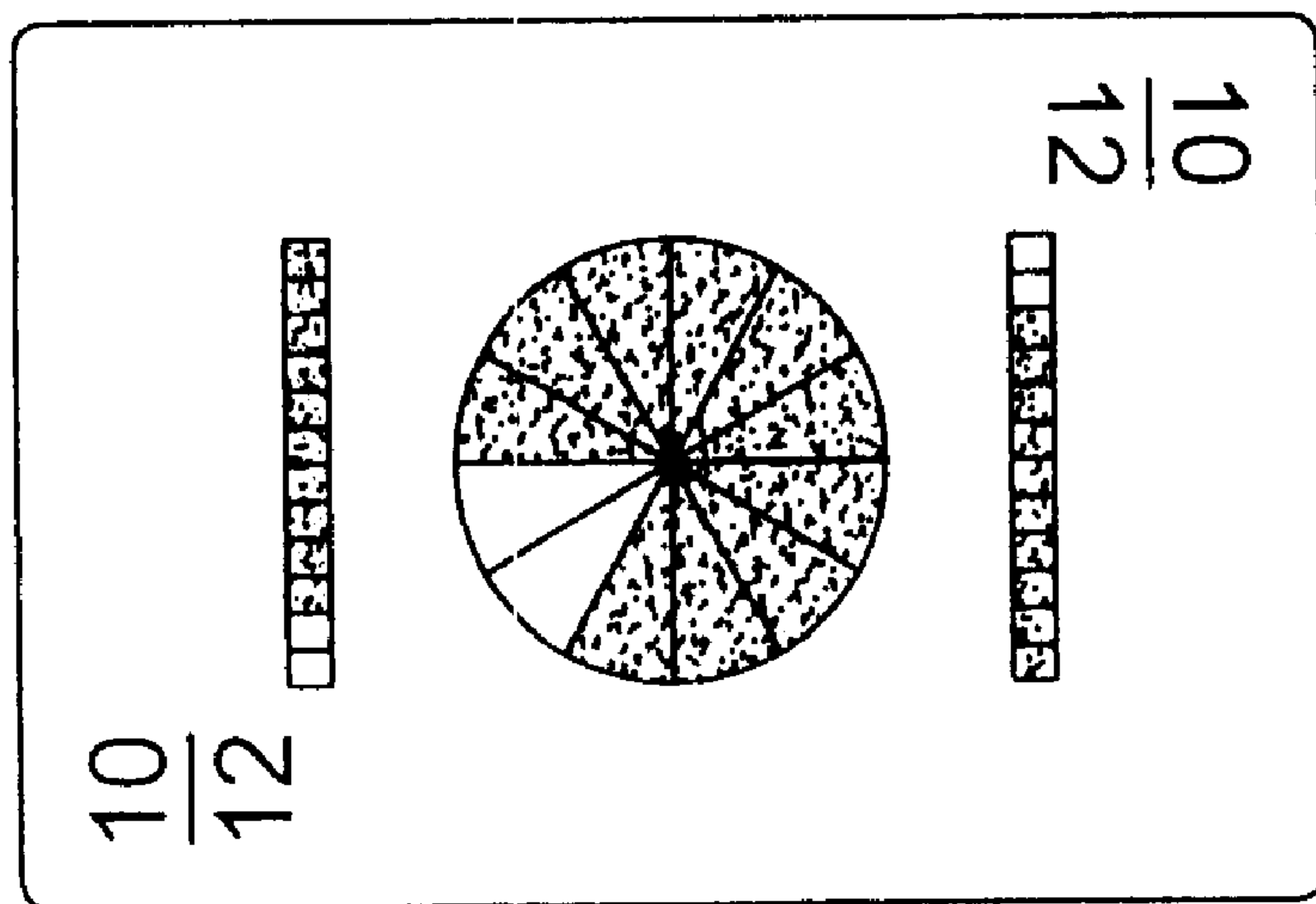

FIG. 65