

US00D541303S

(12) **United States Design Patent**  
**Drew et al.**

(10) **Patent No.: US D541,303 S**  
(45) **Date of Patent: \*\* Apr. 24, 2007**

(54) **AIR CLEANER COVER**  
(75) Inventors: **Christopher J. Drew**, New Berlin, WI (US); **Charles Lasky**, Grafton, WI (US); **Paul A. Leech**, Fox Point, WI (US); **John P. McDonald**, New Berlin, WI (US); **Brian P. Saiia**, Milwaukee, WI (US); **John R. Schneiker**, Muskego, WI (US); **Kipp K. Stevens**, Fox Point, WI (US); **Christina E. Wisler**, Waukesha, WI (US)

(73) Assignee: **Briggs & Stratton Corporation**, Wauwatosa, WI (US)

(\*\*) Term: **14 Years**

(21) Appl. No.: **29/264,106**

(22) Filed: **Aug. 3, 2006**

**Related U.S. Application Data**

(62) Division of application No. 29/232,000, filed on Jun. 13, 2005.

(51) **LOC (8) Cl.** ..... **15-01**

(52) **U.S. Cl.** ..... **D15/5**

(58) **Field of Classification Search** ..... D15/1, D15/3, 5; D12/110, 114, 126; D23/364-365, D23/355; 123/195 C, 572-573, 41.7, 198 E; 55/510, 330, 385.3, 337, 598, 521, 359, 459.1  
See application file for complete search history.

(56) **References Cited**

**U.S. PATENT DOCUMENTS**

D293,796 S \* 1/1988 Nagy ..... D15/5  
5,368,621 A \* 11/1994 Pool ..... 55/323  
D394,236 S 5/1998 Verlengiere  
D446,489 S 8/2001 Park

D447,456 S 9/2001 Larson et al.  
D452,672 S 1/2002 Kim  
D467,846 S 12/2002 McGee  
D518,420 S \* 4/2006 Schmidt ..... D12/126  
D522,931 S \* 6/2006 Simpson ..... D12/126  
D529,925 S \* 10/2006 Strandell et al. .... D15/5

**OTHER PUBLICATIONS**

KAWASAKI, Four-Cycle Engines, Kawasaki FJ180V, website, [http://www.kawpowr.com/4cycle/fj180v\\_specs.html](http://www.kawpowr.com/4cycle/fj180v_specs.html), 1 page, Feb. 2, 2005.

KAWASAKI, Four-Cycle Engines, Kawasaki FC290v, website, [http://www.kawpowr.com/4cycle/fc290v\\_specs.html](http://www.kawpowr.com/4cycle/fc290v_specs.html), 1 page, Feb. 2, 2005.

(Continued)

*Primary Examiner*—Ian Simmons

*Assistant Examiner*—Maurice Stevens

(74) *Attorney, Agent, or Firm*—Michael Best & Friedrich LLP

(57) **CLAIM**

We claim the ornamental design for an air cleaner cover, as shown and described.

**DESCRIPTION**

FIG. 1 is a perspective view of an air cleaner cover according to the invention;  
FIG. 2 is a top view of the air cleaner cover of FIG. 1;  
FIG. 3 is a bottom view of the air cleaner cover of FIG. 1;  
FIG. 4 is a front view of the air cleaner cover of FIG. 1;  
FIG. 5 is a rear view of the air cleaner cover of FIG. 1;  
FIG. 6 is a left side view of the air cleaner cover of FIG. 1;  
and,  
FIG. 7 is a right side view of the air cleaner cover of FIG. 1.

**1 Claim, 7 Drawing Sheets**

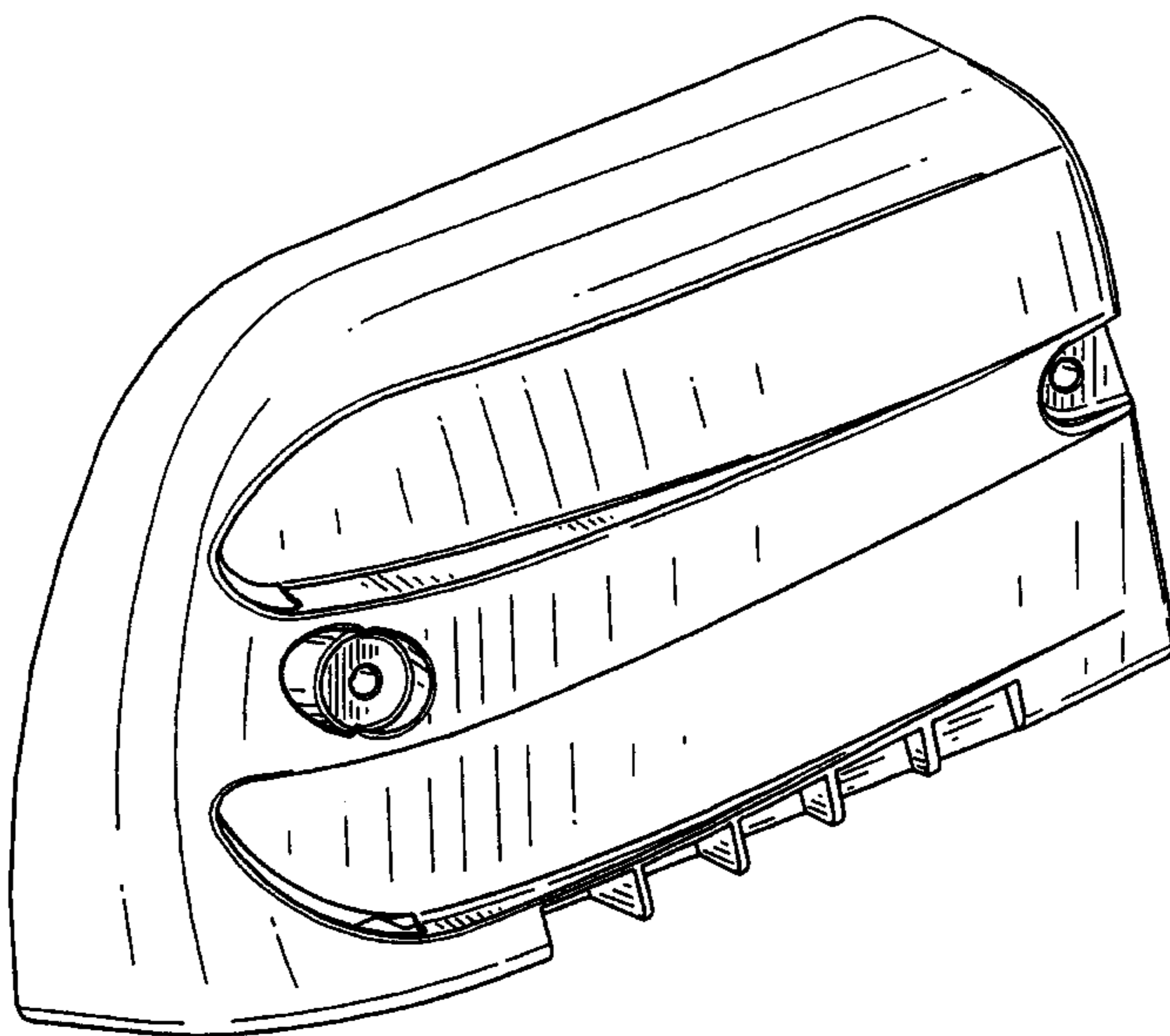

OTHER PUBLICATIONS

KAWASAKI, Four-Cycle Engines, Kawasaki FH721D, website, [http://www.kawpowr.com/4cycle/fh721d\\_specs.html](http://www.kawpowr.com/4cycle/fh721d_specs.html), 1 page, Feb. 2, 2005.

KAWASAKI, Four-Cycle Engines, Kawasaki FH601D, website, [http://www.kawpowr.com/4cycle/fh601d\\_specs.html](http://www.kawpowr.com/4cycle/fh601d_specs.html), 1 page, Feb. 2, 2005.

KAWASAKI, Four-Cycle Engines, Kawasaki FH601V, website, [http://www.kawpowr.com/4cycle/fh601v\\_specs.html](http://www.kawpowr.com/4cycle/fh601v_specs.html), 1 page, Feb. 2, 2005.

KAWASAKI, Four-Cycle Engines, Kawasaki FH500V, website, [http://www.kawpowr.com/4cycle/fh500v\\_specs.html](http://www.kawpowr.com/4cycle/fh500v_specs.html), 1 page, Feb. 2, 2005.

KAWASAKI, Four-Cycle Engines, Kawasaki FC150V, website, [http://www.kawpowr.com/4cycle/fc150v\\_specs.html](http://www.kawpowr.com/4cycle/fc150v_specs.html), 1 page, Feb. 2, 2005.

KAWASAKI, Four-Cycle Engines, Kawasaki FH721V, website, [http://www.kawpowr.com/4cycle/fh721v\\_specs.html](http://www.kawpowr.com/4cycle/fh721v_specs.html), 1 page, Feb. 2, 2005.

Tecumseh Power Company; Walk-Behind Engines & Transmissions Horsepower Range: 3.5-7.0, website <http://www.tecumsehpower.com/Products/WalkBehind/index.php>, 1 page, Feb. 2, 2005.

Kohler Co. Engine Division; Kohler Engines Born to Run Owner's Manual, Command 11-16 HP Vertical Crankshaft; Cover Sheet, Revised Sep. 1999, Kohler Co. Engine Division, Kohler, Wisconsin, USA.

Kohler Co. Engine Division; Kohler Engines Born to Run Owner's Manual, Command 18-26 HP Horizontal Crankshaft; Cover Sheet, Revised May 1999, Kohler Co. Engine Division, Kohler, Wisconsin, USA.

Kohler Co. Engine Division; Kohler Engines Born to Run Owner's Manual, Command 11-15 HP Horizontal Crankshaft; Cover Sheet, Revised Apr. 1999, Kohler Co. Engine Division, Kohler, Wisconsin, USA.

Kohler Co. Engine Division; Kohler Engines Born to Run Owner's Manual, Magnum 8,12,16 HP Horizontal Crankshaft; Cover Sheet, Revised Dec. 2001, Kohler Co. Engine Division, Kohler, Wisconsin, USA.

Kohler Co. Engine Division; Kohler Engines Service Manual, Courage Series SV470-600 Vertical Crankshaft; website [http://www.kohlerengines.com/onlinecatalog/detail.jsp?prod\\_num=Hydro+13](http://www.kohlerengines.com/onlinecatalog/detail.jsp?prod_num=Hydro+13), Cover Sheet, Feb. 2, 2005, Kohler Co. Engine Division, Kohler, Wisconsin, USA.

Kohler Co. Engine Division; Kohler Engines Kohler Triad OHC; website [http://www.kohlerengines.com/onlinecatalog/enginefamily.jsp?engine\\_family\\_name=Triad+OHC](http://www.kohlerengines.com/onlinecatalog/enginefamily.jsp?engine_family_name=Triad+OHC), Cover Sheet Feb. 2, 2005, Kohler Co. Engine Division, Kohler, Wisconsin, USA.

Honda Engines, Honda GC Series Engines, brochure, 2003, 10 pages, American Honda Motor Co, Inc.

\* cited by examiner

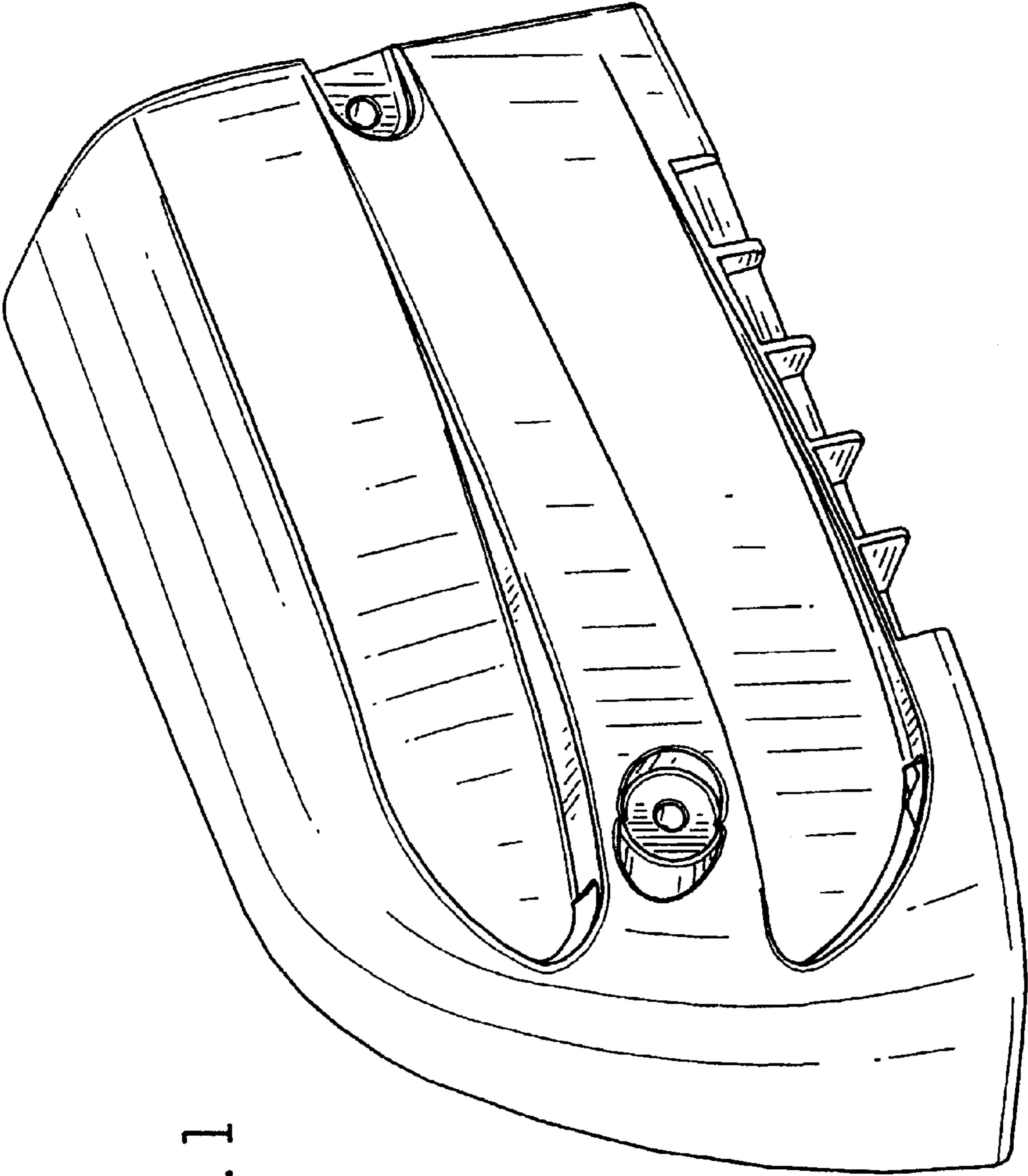

FIG. 1

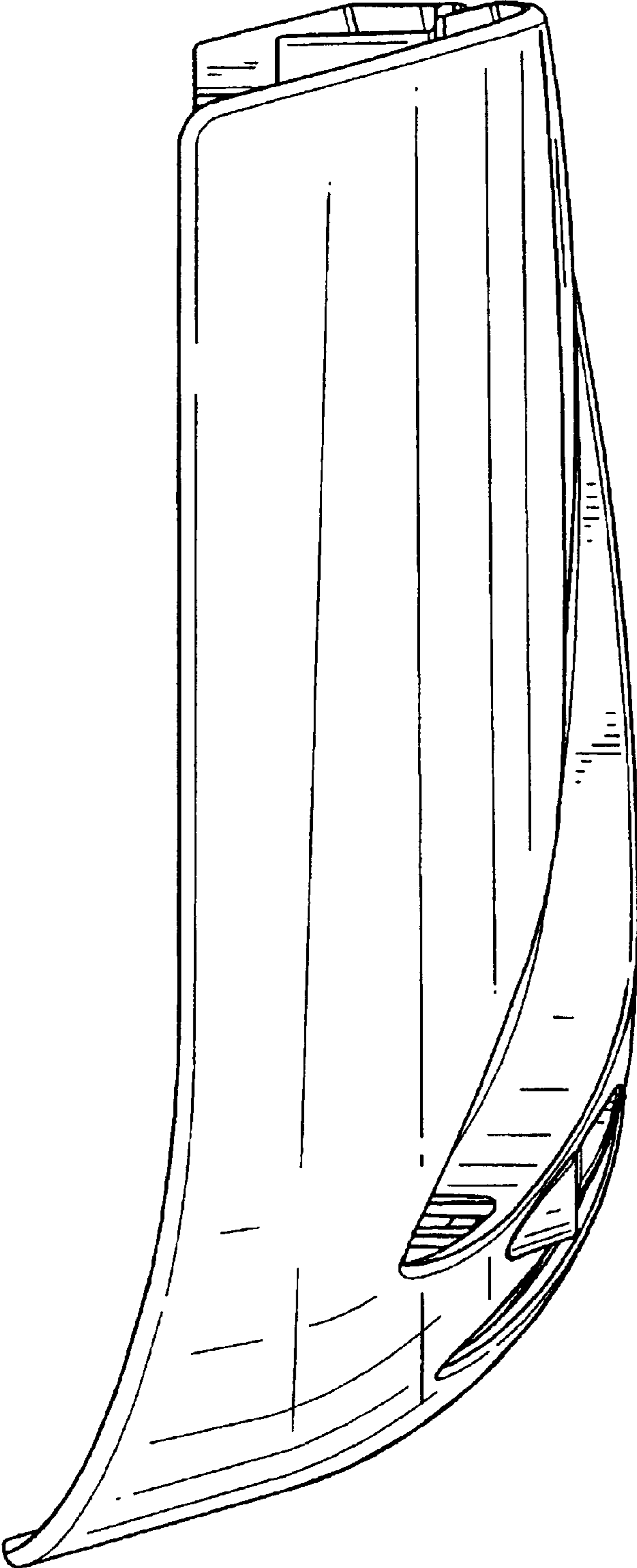

FIG. 2

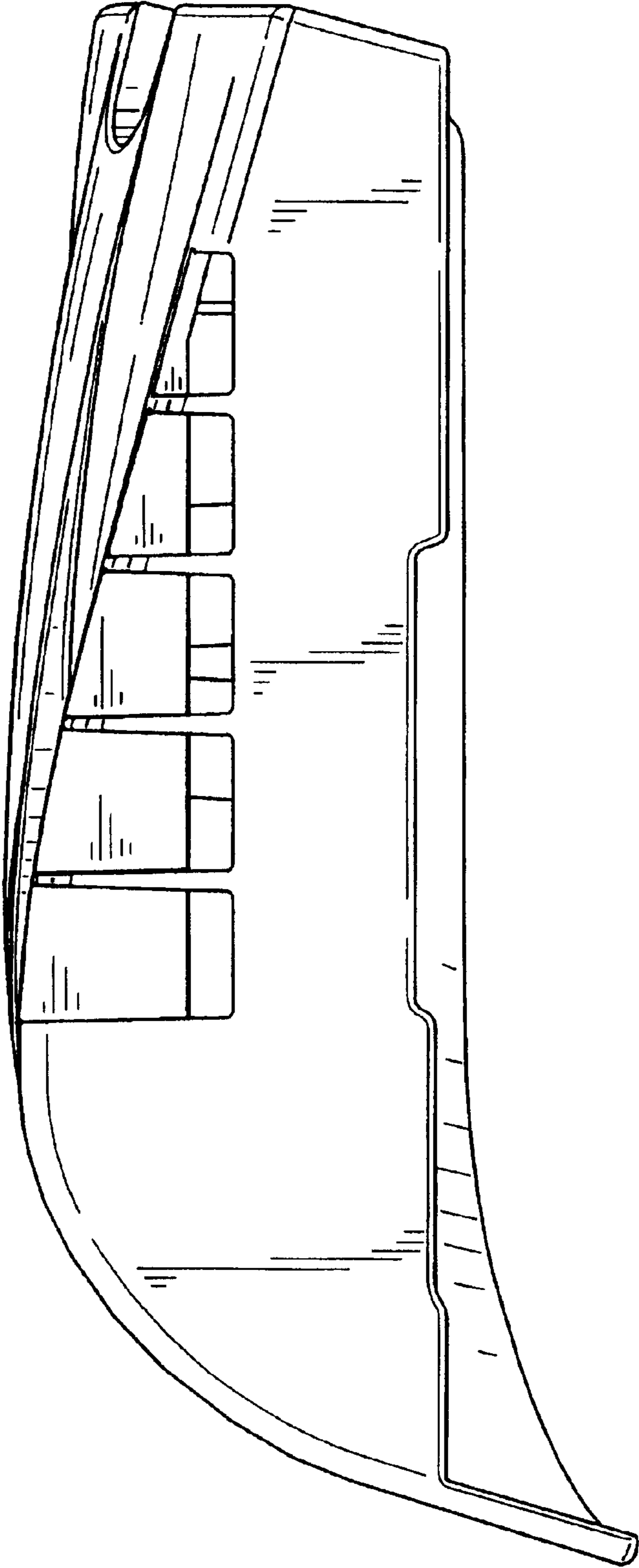

FIG. 3

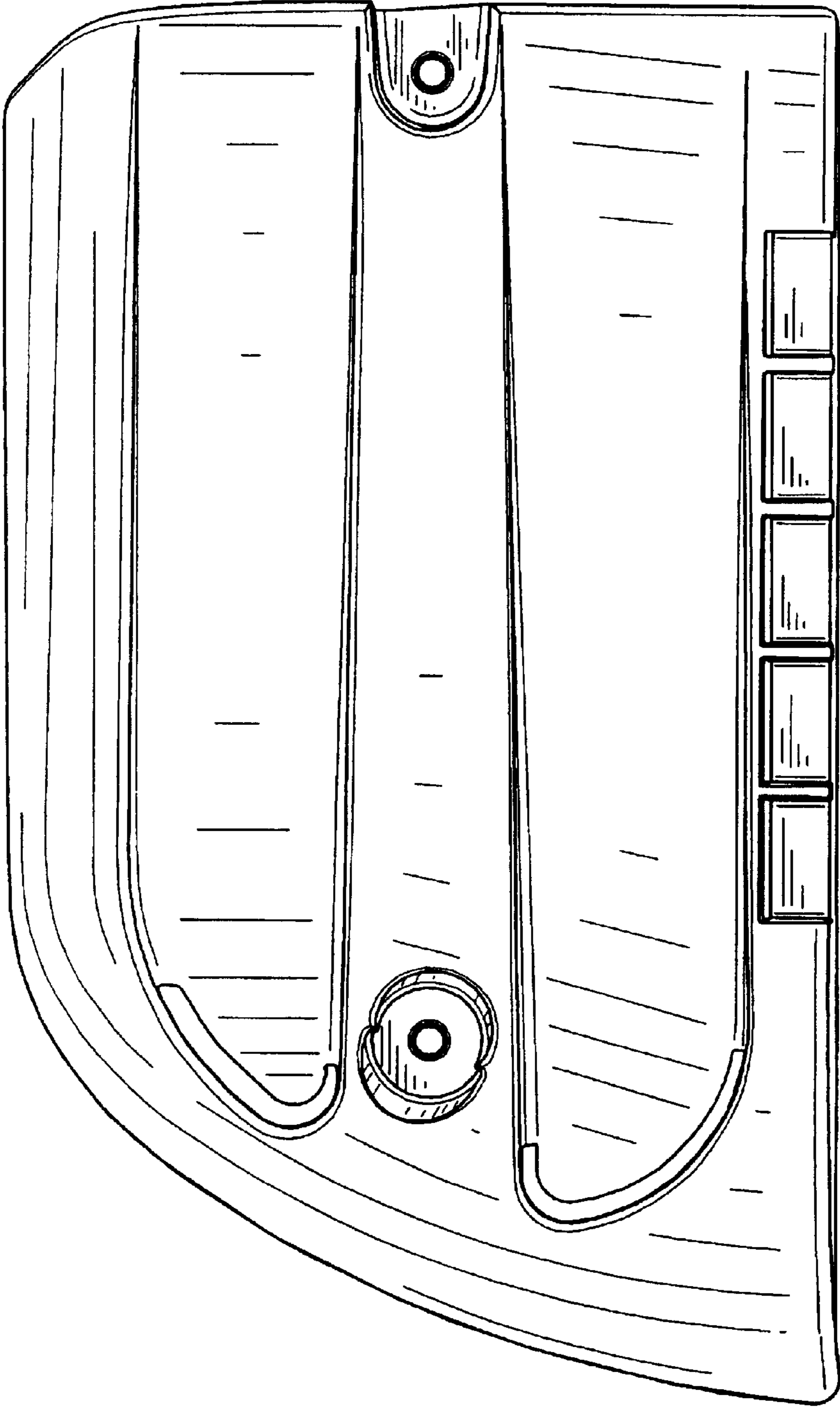

FIG. 4

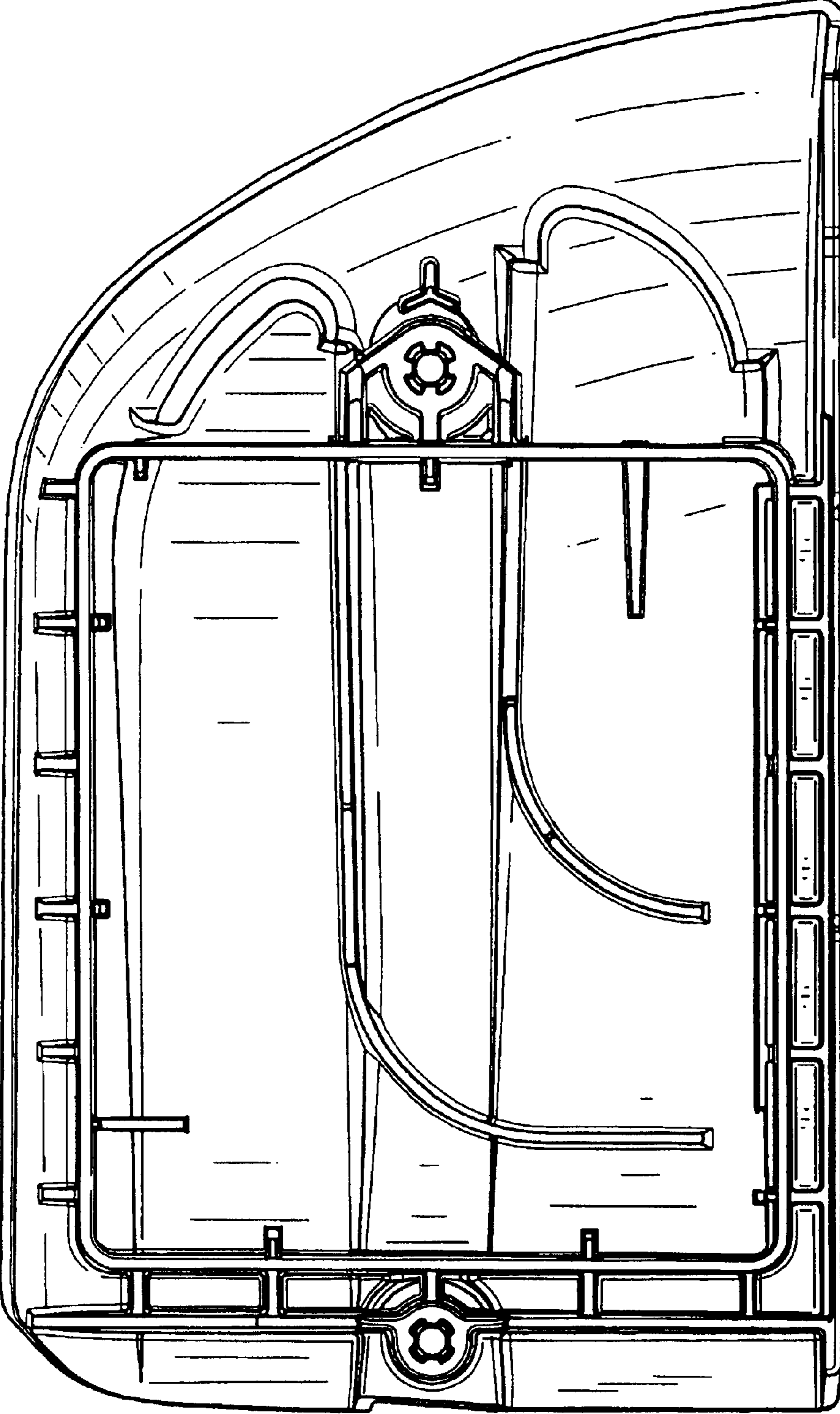

FIG. 5

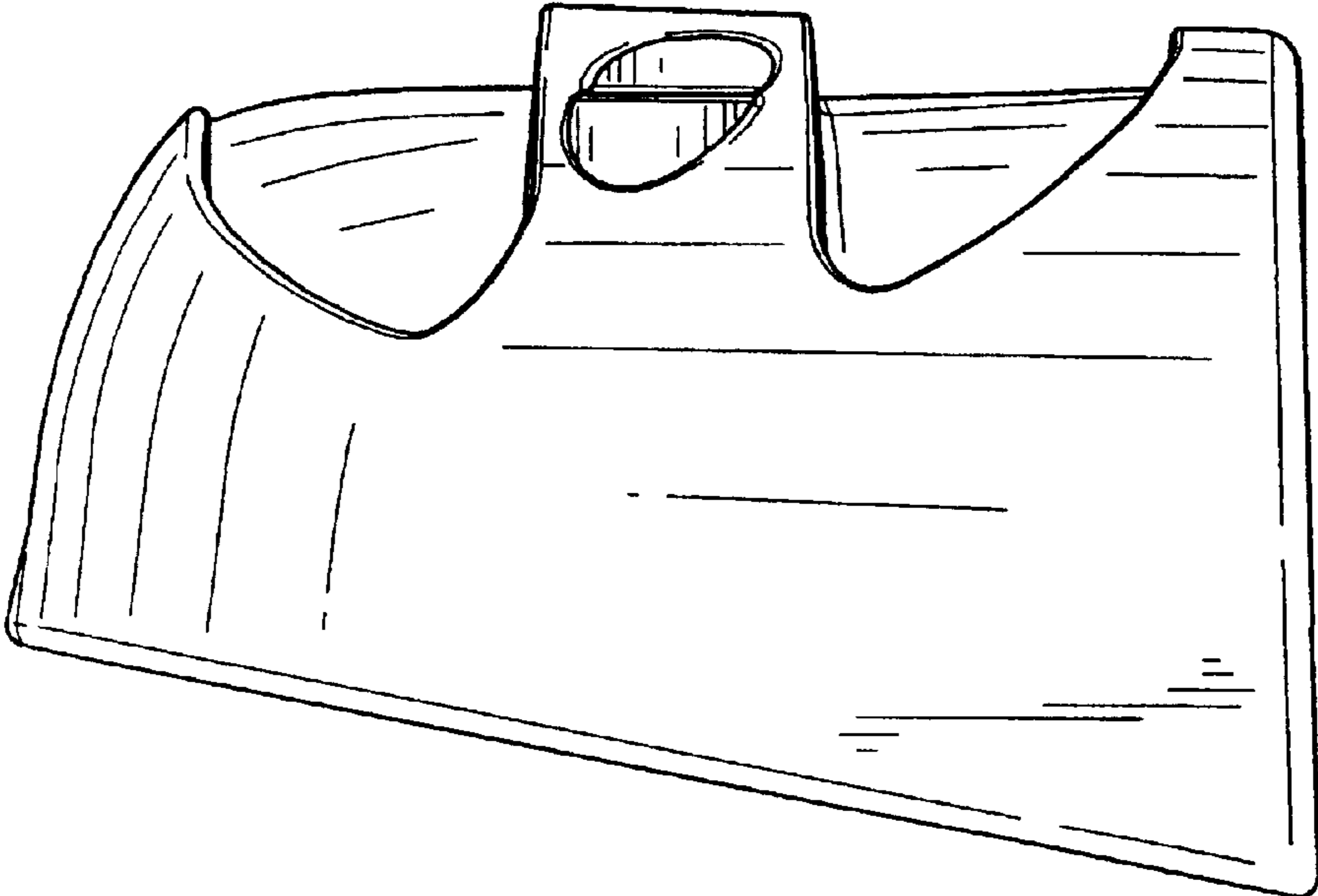

FIG. 6



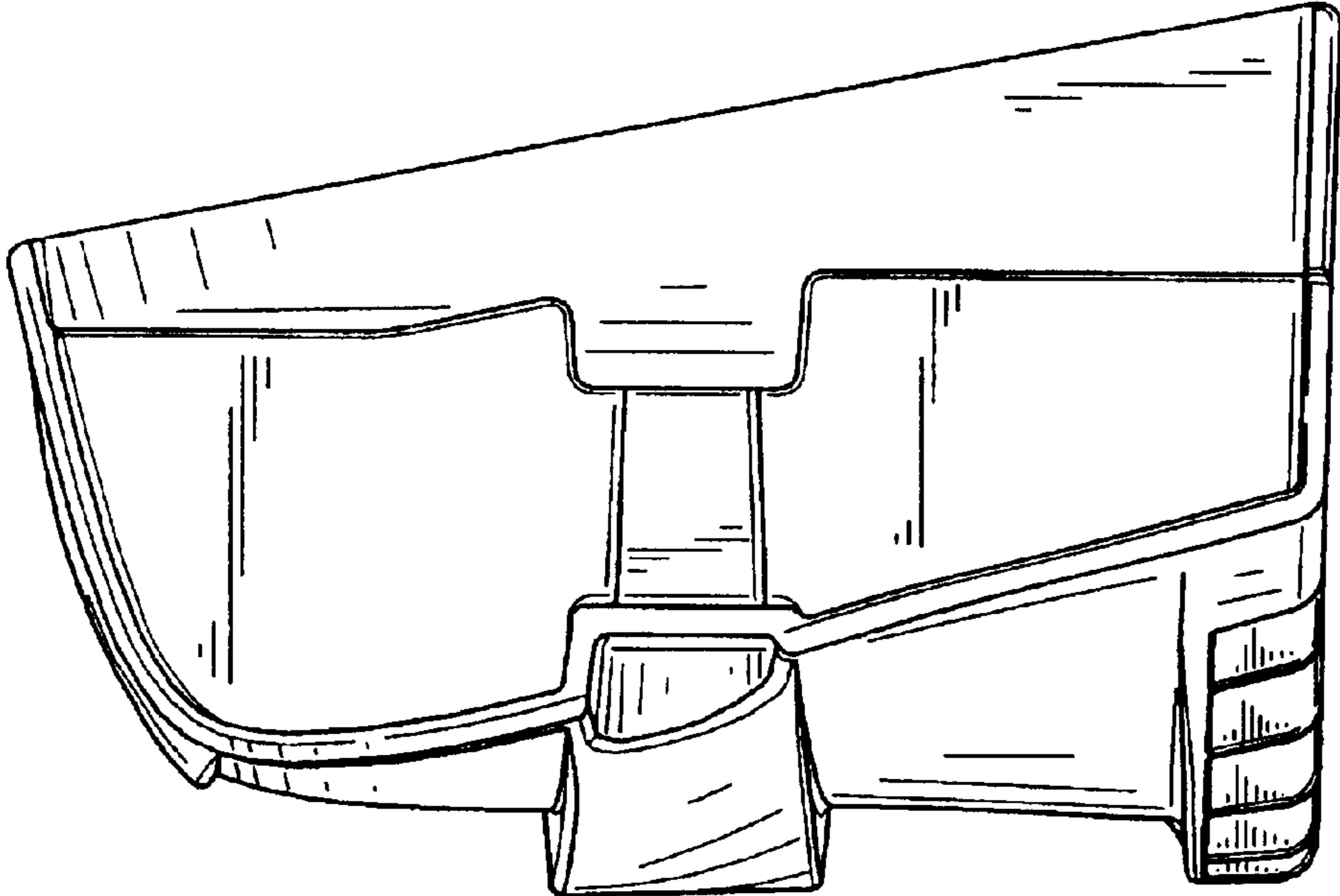

FIG. 7