



US00D541249S

(12) **United States Design Patent**
Hirano

(10) **Patent No.:** **US D541,249 S**

(45) **Date of Patent:** **** Apr. 24, 2007**

(54) **MOBILE PHONE**

(75) Inventor: **Shimpei Hirano**, Malmö (SE)

(73) Assignee: **Ericsson Mobile Communications AB**,
Lund (SE)

(**) Term: **14 Years**

(21) Appl. No.: **29/234,847**

(22) Filed: **Jul. 25, 2005**

(30) **Foreign Application Priority Data**

Feb. 3, 2005 (EM) 000289293-0001/0002

(51) **LOC (8) Cl.** **14-03**

(52) **U.S. Cl.** **D14/138**

(58) **Field of Classification Search** D14/137,
D14/138, 147-148, 247-248, 144, 496, 156,
D14/341-347; 379/433.01-433.13; 455/575.4,
455/566, 575.1, 556.1, 556.2, 90.3; D21/329,
D21/331, 333; D16/208

See application file for complete search history.

(56) **References Cited**

U.S. PATENT DOCUMENTS

D466,096 S	*	11/2002	Takada	D14/138
D479,215 S	*	9/2003	Yokoyama	D14/138
D483,032 S	*	12/2003	Bertrand et al.	D14/248
D496,644 S	*	9/2004	Yoo et al.	D14/138
D497,604 S	*	10/2004	Lee	D14/138
D502,457 S	*	3/2005	Eigenstetter et al.	D14/138
D502,932 S	*	3/2005	Minamide	D14/138
D503,694 S	*	4/2005	Itano	D14/138
D503,699 S	*	4/2005	Lee et al.	D14/138
D508,473 S	*	8/2005	Lee et al.	D14/138
D509,202 S	*	9/2005	Lee et al.	D14/138
D509,206 S	*	9/2005	Jang	D14/138
D509,813 S	*	9/2005	Miyazawa et al.	D14/138
D511,342 S	*	11/2005	Chien	D14/346
D513,011 S	*	12/2005	Johnson	D14/496
D515,543 S	*	2/2006	Shintani	D14/138
D518,012 S	*	3/2006	Fuxen	D14/138
2004/0259592 A1	*	12/2004	Taneya et al.	455/556.1
2004/0266477 A1	*	12/2004	Murata	455/556.1

2005/0075082 A1	*	4/2005	Iwai et al.	455/90.3
2005/0107126 A1	*	5/2005	Kim	455/565
2005/0190291 A1	*	9/2005	Kota et al.	348/376
2005/0202856 A1	*	9/2005	Park et al.	455/575.1
2005/0250532 A1	*	11/2005	Hwang et al.	455/550.1
2005/0255897 A1	*	11/2005	Lee et al.	455/575.4
2006/0019726 A1	*	1/2006	Park et al.	455/575.1
2006/0025184 A1	*	2/2006	Cho et al.	455/575.4

FOREIGN PATENT DOCUMENTS

WO	DM/067414	*	12/2005
WO	DM/067482	*	12/2005

OTHER PUBLICATIONS

Pantech PG3000 telephone, announced first quarter 2005, [online], [retrieved on Apr. 9, 2006]. Retrieved from Internet, URL: <http://www.gsmarena.com>>.*

Sony-Ericsson W550 telephone, announced Jul. 2005, [online], [retrieved on Apr. 28, 2006]. Retrieved from Internet, URL: <http://www.gsmarena.com>>.*

(Continued)

Primary Examiner—Jeffrey Asch

(74) *Attorney, Agent, or Firm*—Timothy Platt; Albihsn Stockholm AB

(57) **CLAIM**

The ornamental design for a mobile phone, as shown.

DESCRIPTION

FIG. 1 is a front right perspective view of a mobile phone in a closed position according to my new design, FIG. 2 is a front view thereof; FIG. 3 is a right side view thereof; FIG. 4 is a left side view thereof; FIG. 5 is a rear view thereof; FIG. 6 is a top view thereof; FIG. 7 is a bottom view thereof; FIG. 8 is a front right perspective view of a mobile phone in an open position according to my new design; FIG. 9 is a front view thereof; FIG. 10 is a right side view thereof; FIG. 11 is a left side view thereof; FIG. 12 is a rear view thereof; FIG. 13 is a top view thereof; and, FIG. 14 is a bottom view thereof.

1 Claim, 4 Drawing Sheets

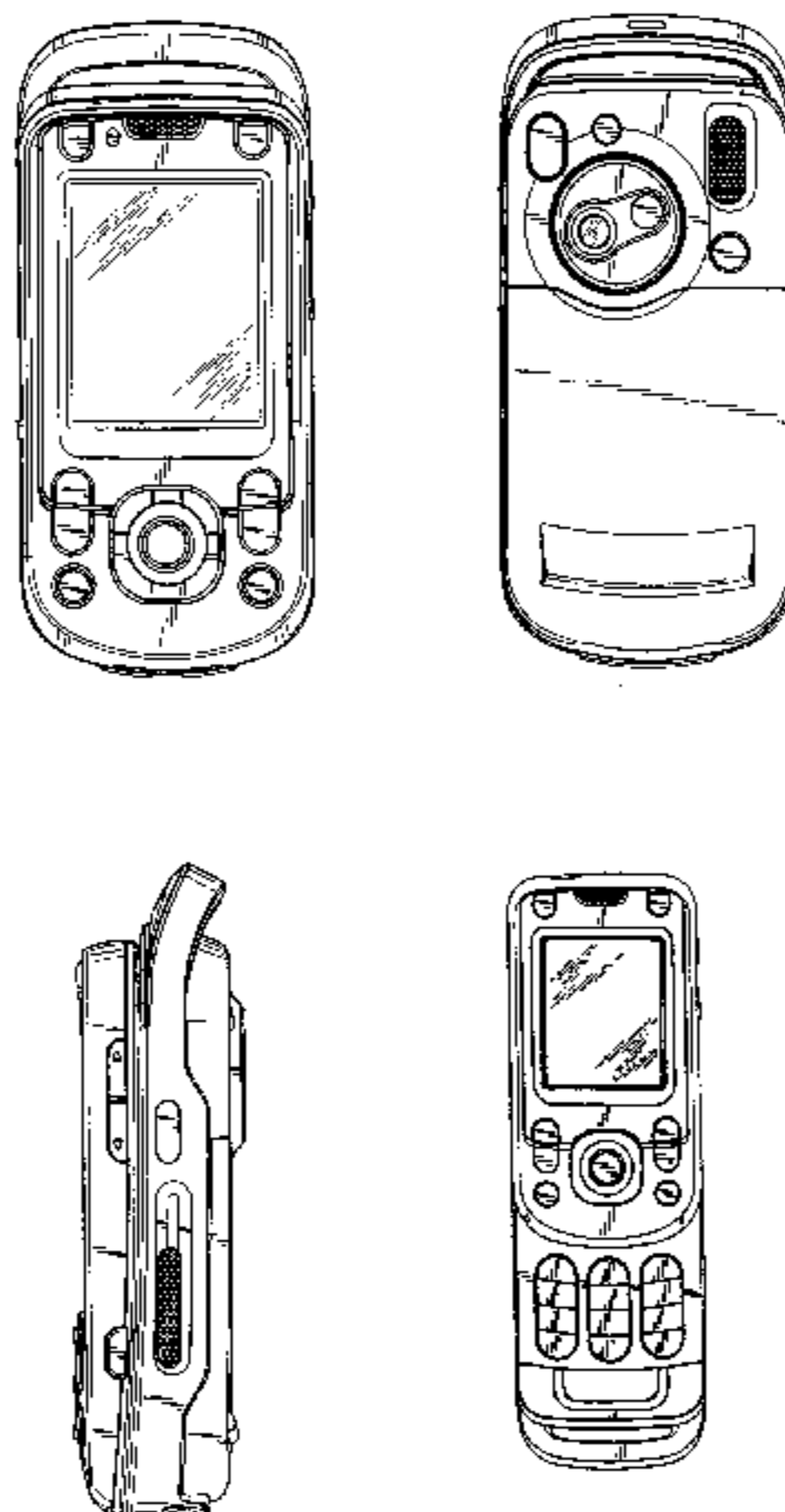

OTHER PUBLICATIONS

Siemens CF62 telephone, announced Feb. 2004, [online], [retrieved on Mar. 3, 2006]. Retrieved from Internet, URL: <http://www.gsmarena.com>>.*

Sony-Ericsson S710 telephone, announced third quarter 2004, [online], [retrieved on Apr. 28, 2006]. Retrieved from Internet, URL: <http://www.gsmarena.com>>.*

* cited by examiner

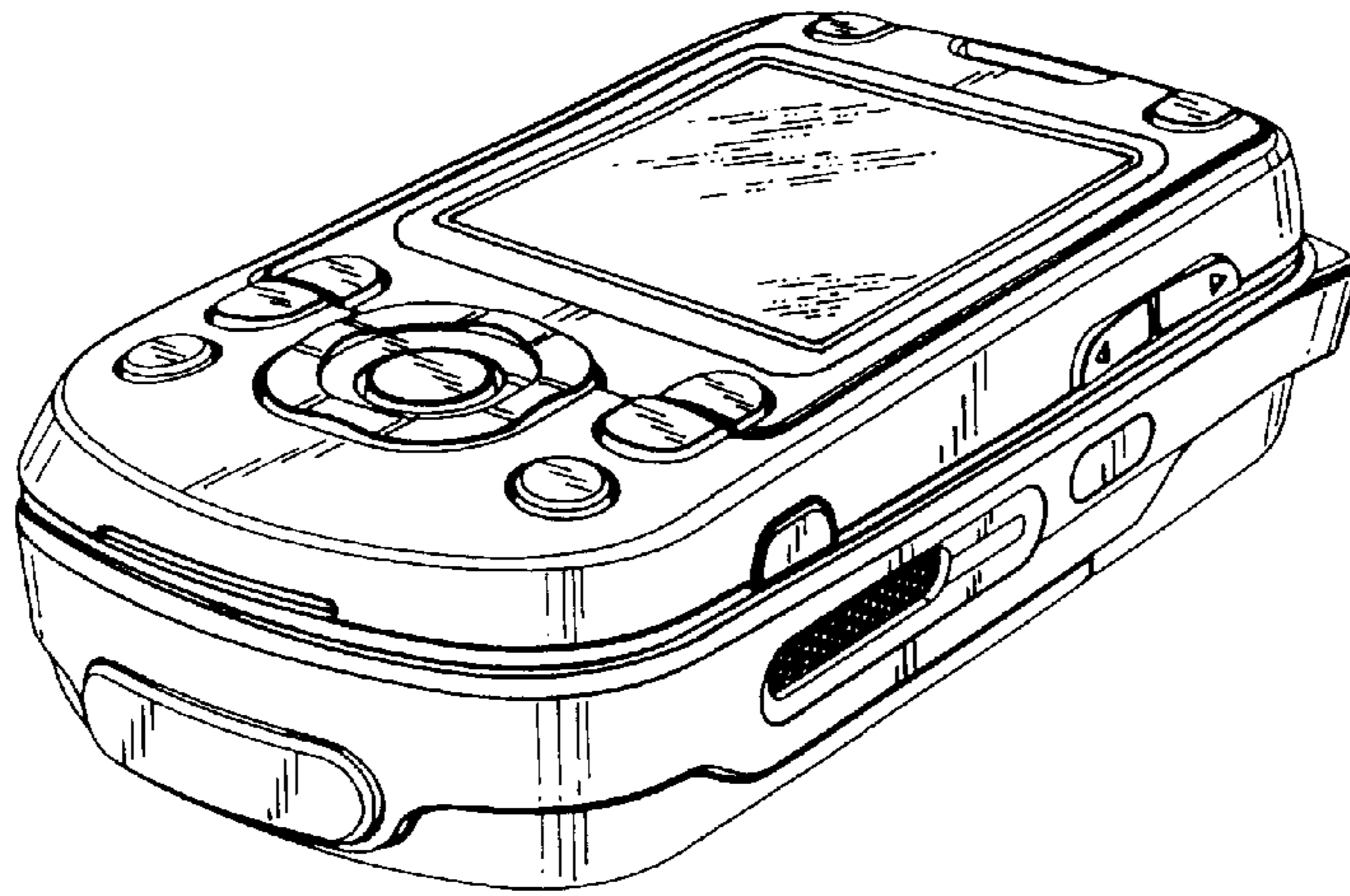

FIG. 1

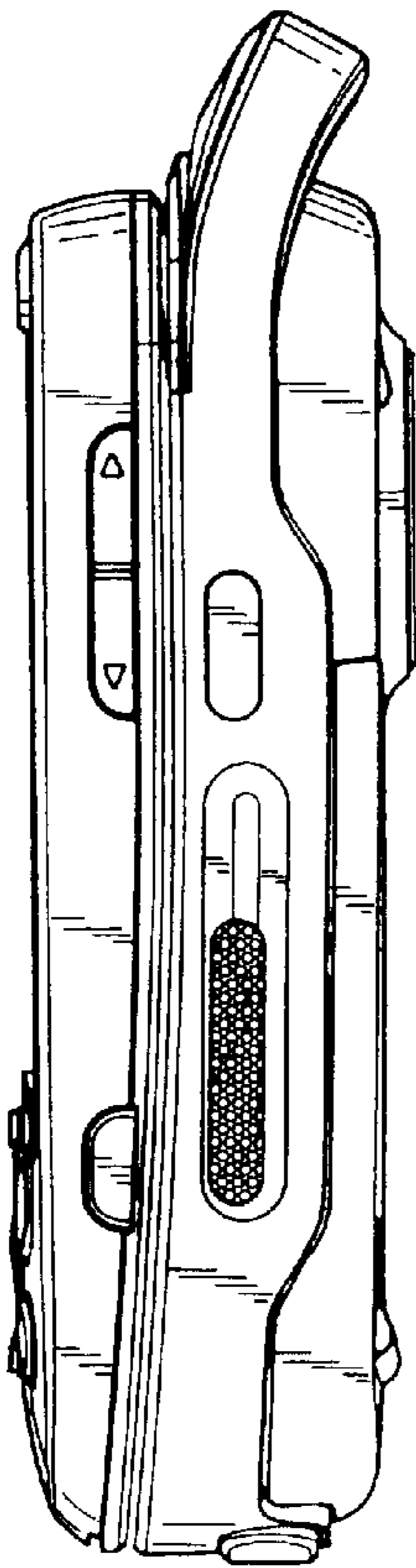

FIG. 3

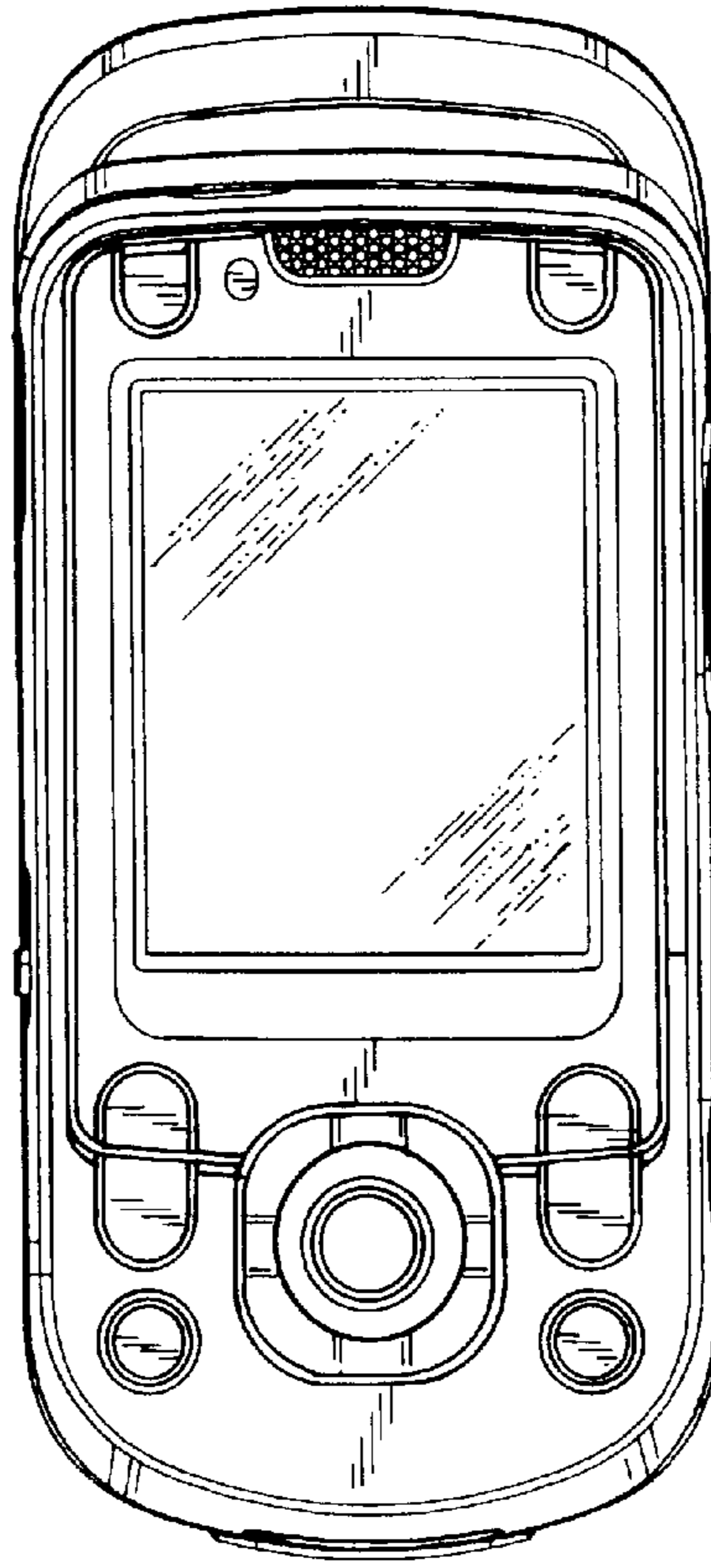

FIG. 2

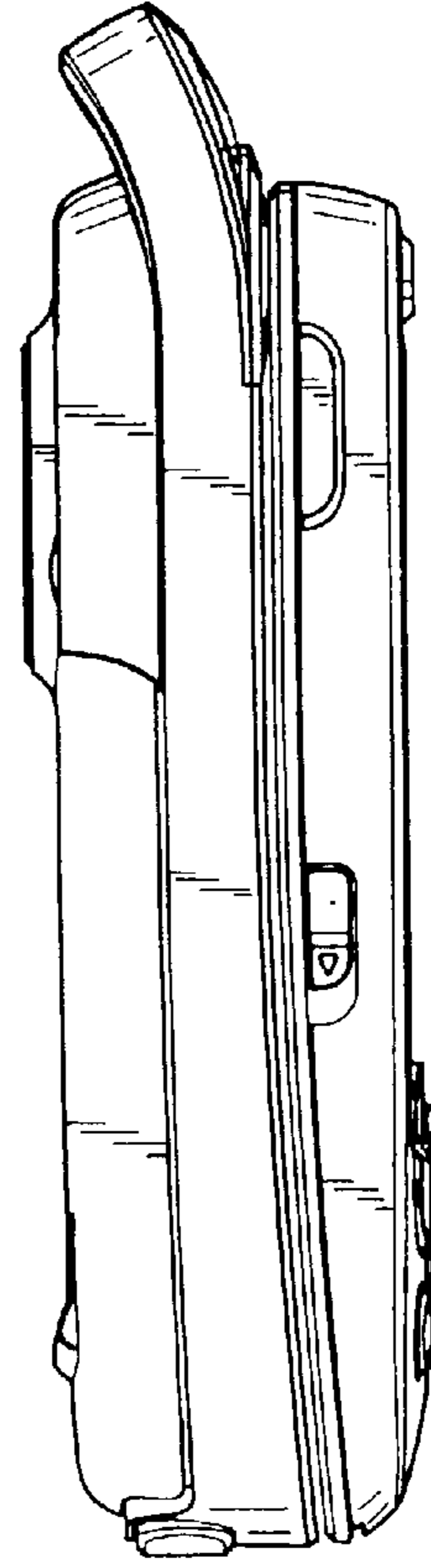

FIG. 4

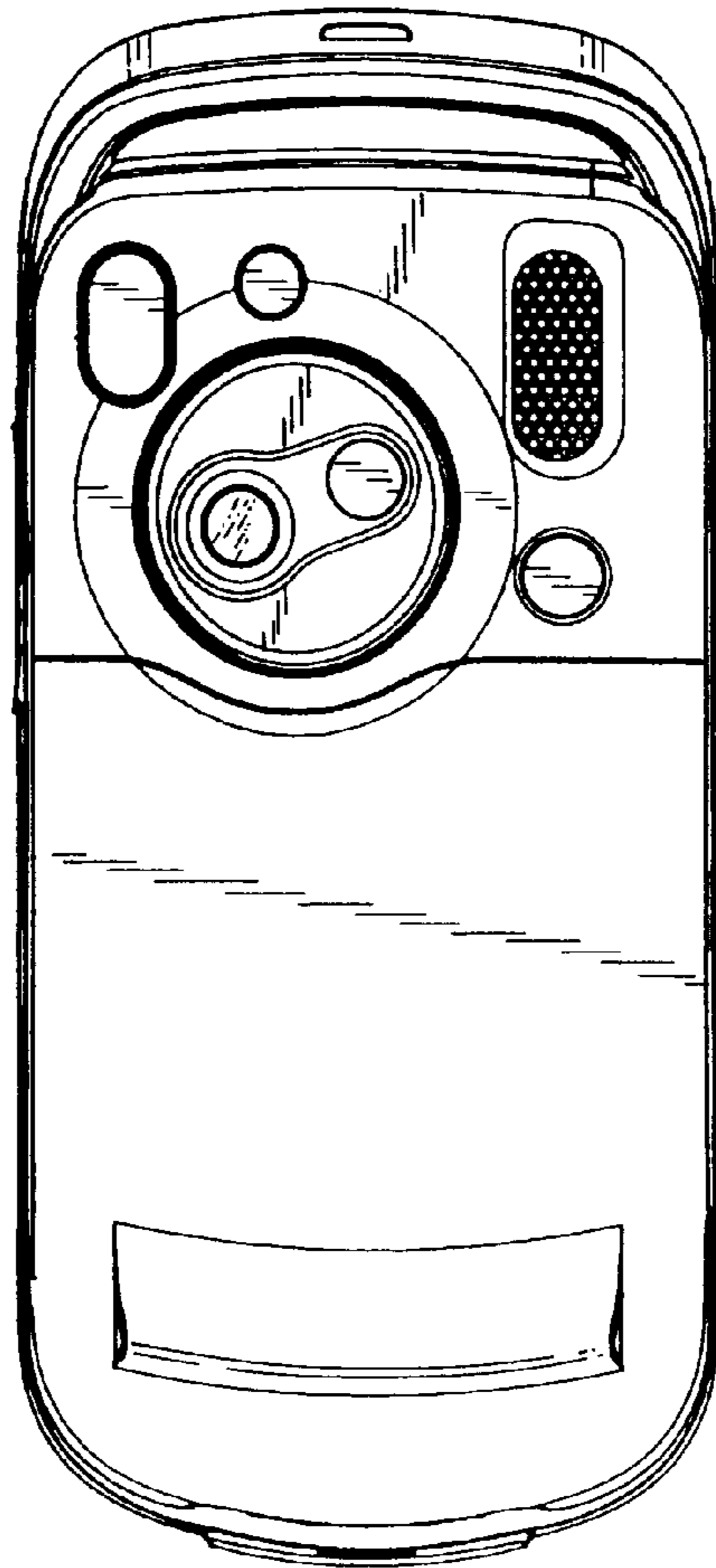

FIG. 5

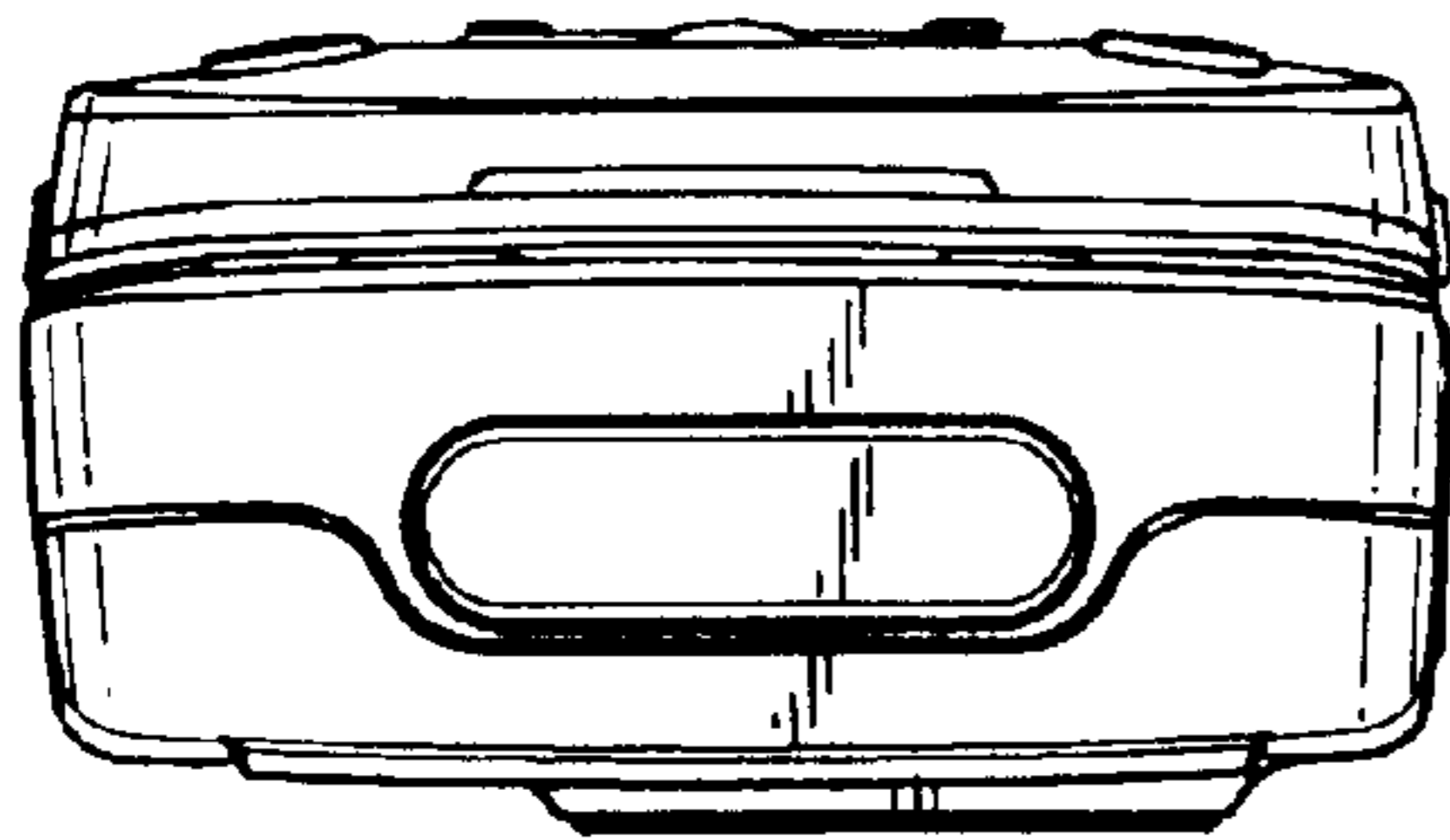

FIG. 6

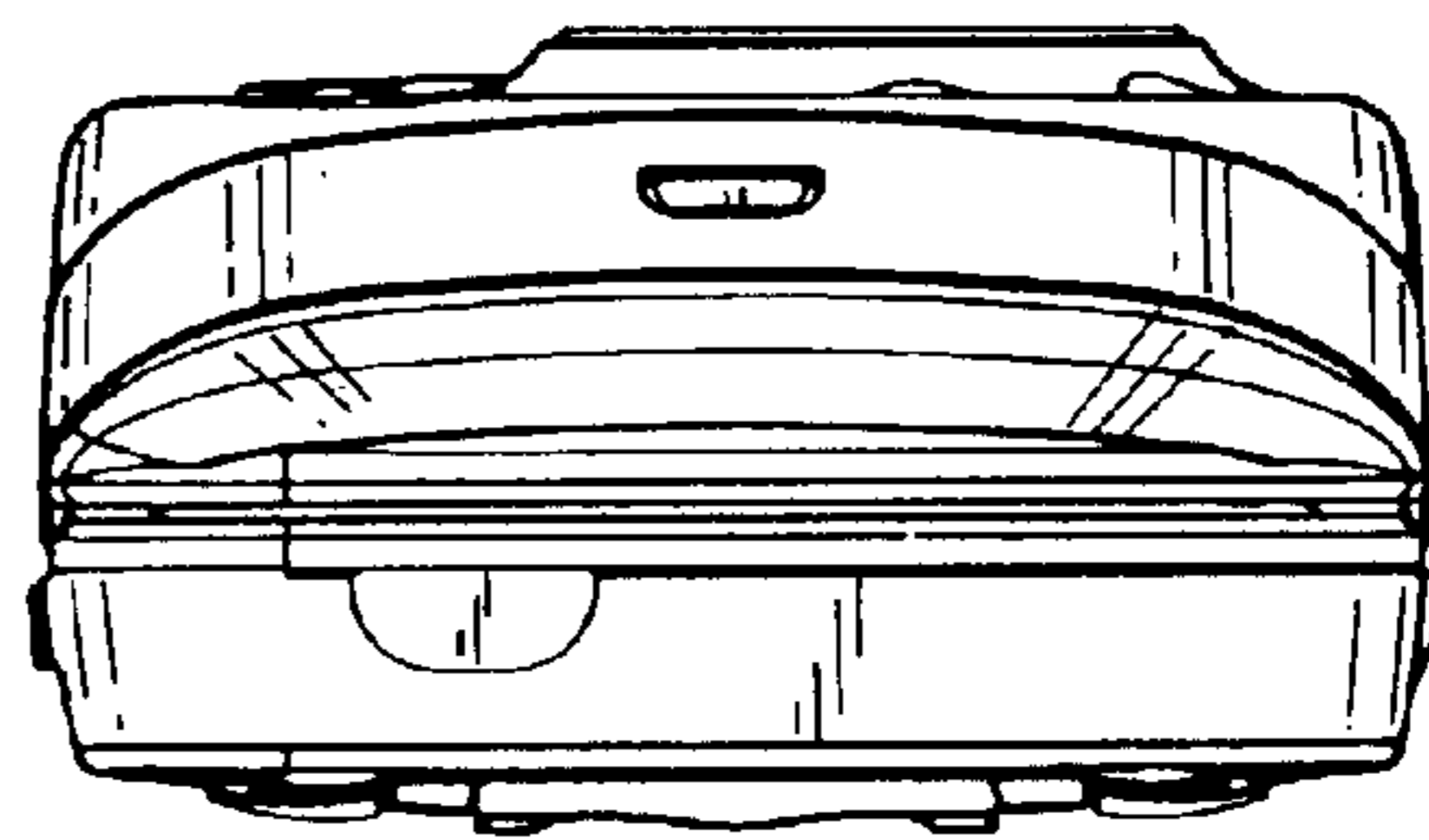

FIG. 7

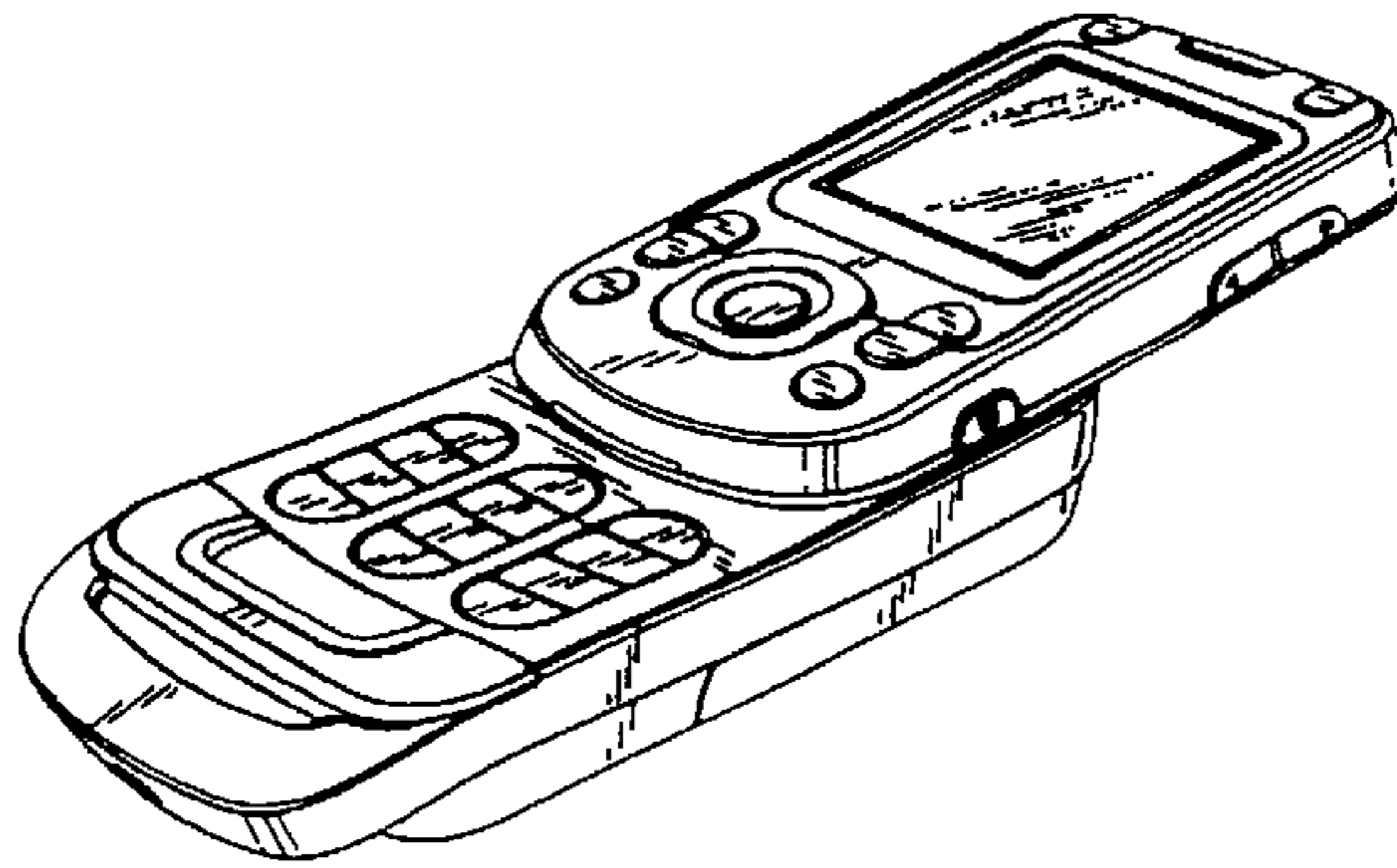

Fig. 8

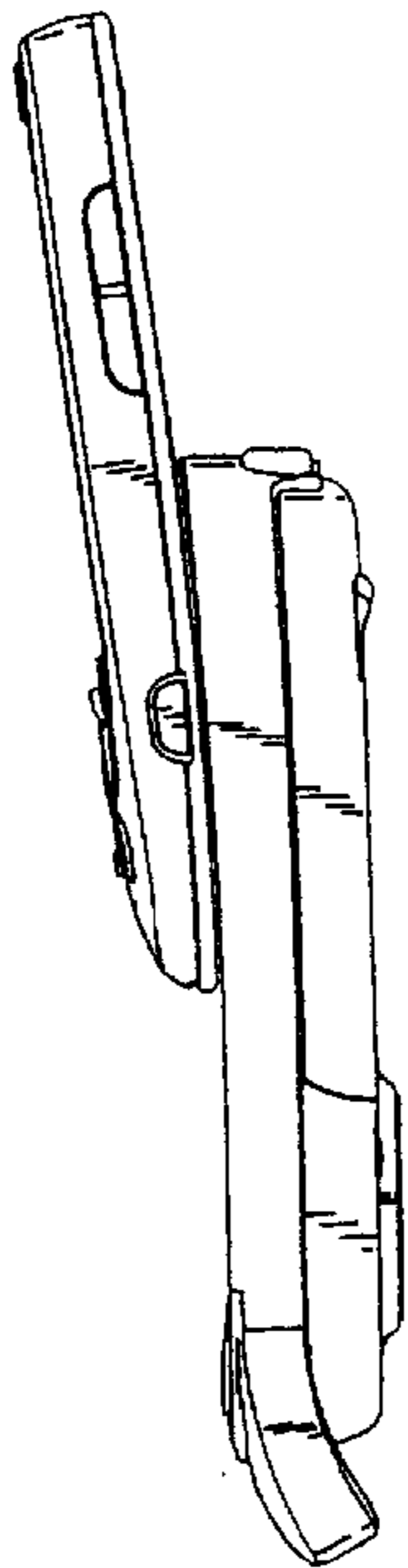

Fig. 10

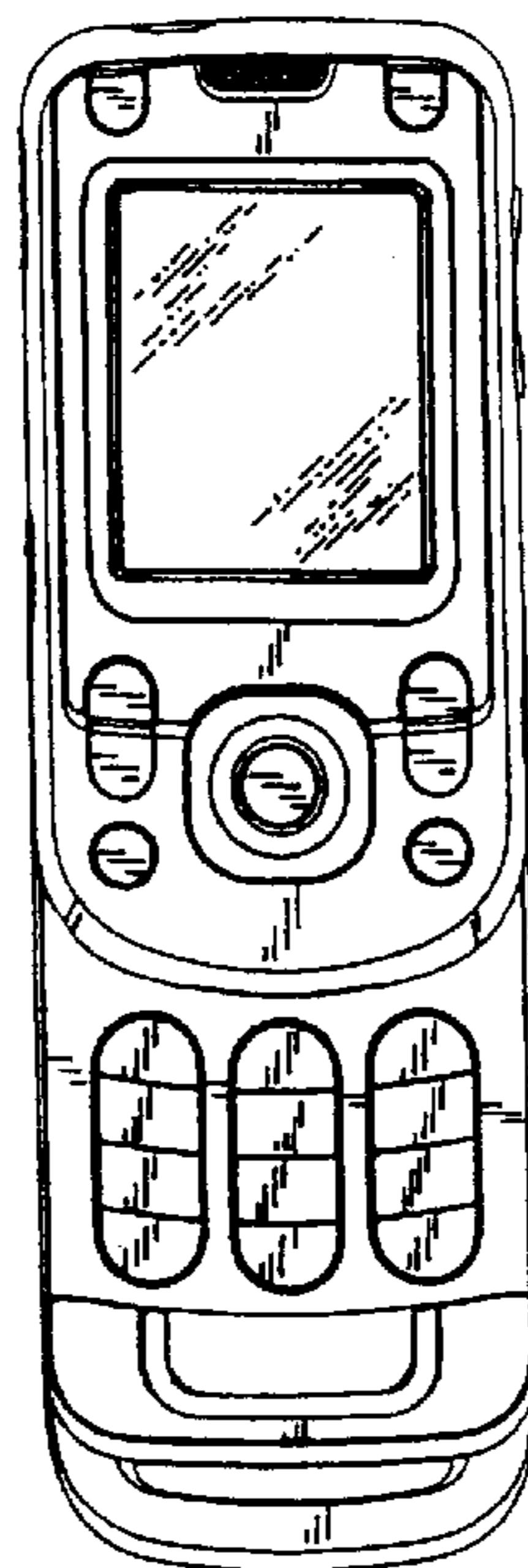

Fig. 9

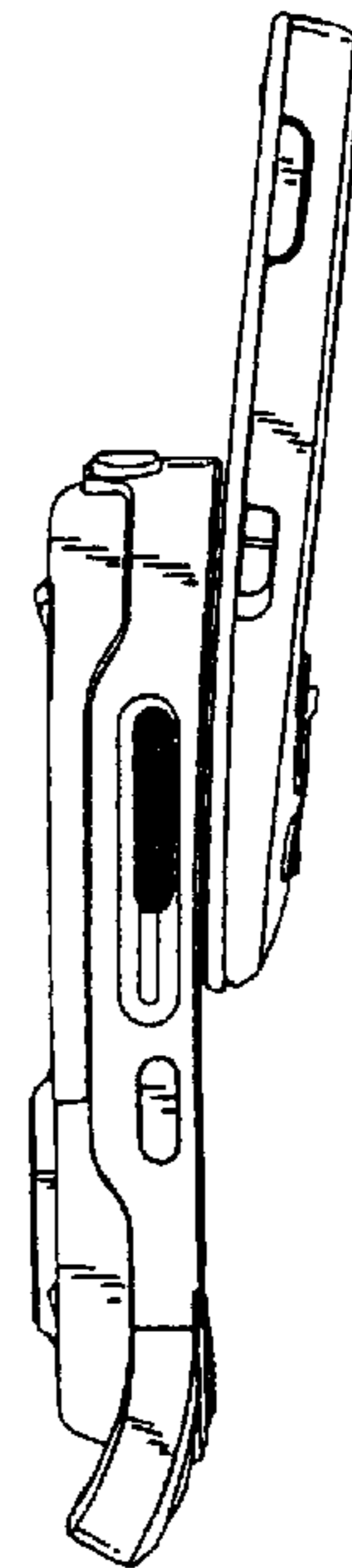

Fig. 11

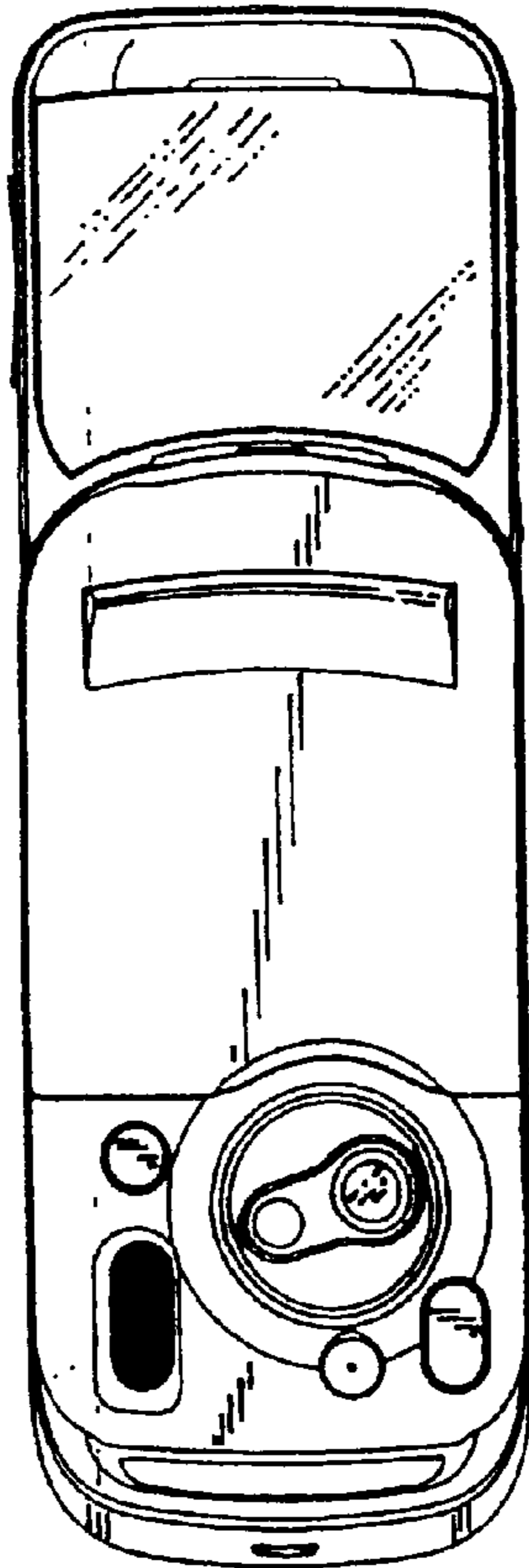

Fig. 12

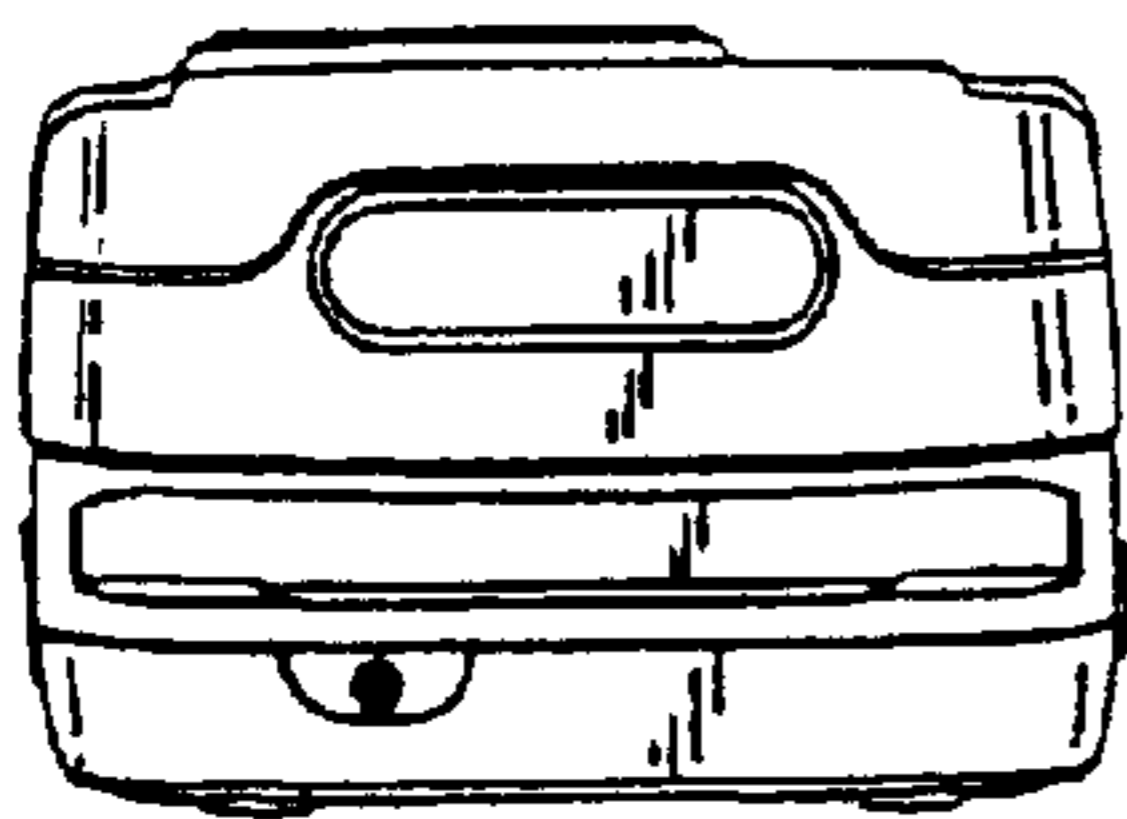

Fig. 13

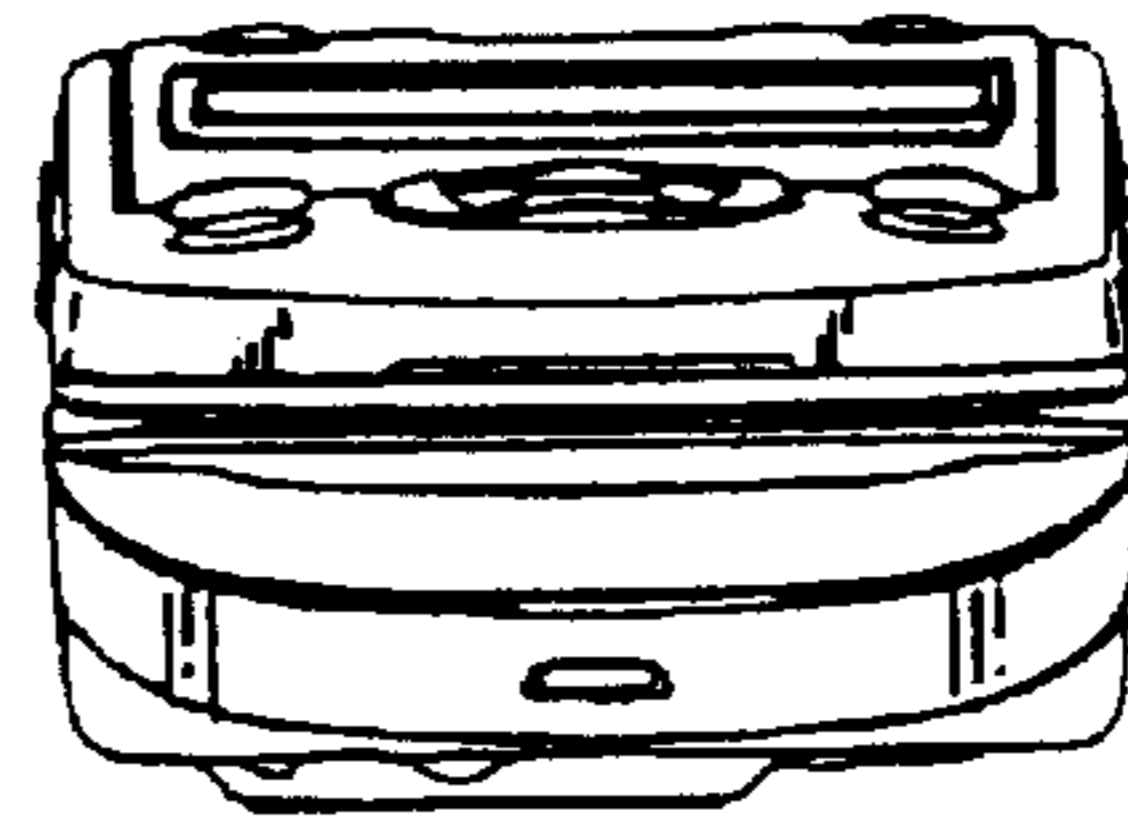

Fig. 14