

US00D541195S

(12) **United States Design Patent**  
**Bracy et al.**

(10) **Patent No.:** **US D541,195 S**

(45) **Date of Patent:** **\*\* Apr. 24, 2007**

(54) **MOTORCYCLE**

(75) Inventors: **Garth Bracy**, Long Lake, MN (US);  
**Gregory Brew**, Minnetonka, MN (US);  
**John W Callahan**, St. Paul, MN (US);  
**Michael Song**, Maple Grove, MN (US)

(73) Assignee: **Polaris Industries Inc.**, Medina, MN  
(US)

(\*\*) Term: **14 Years**

(21) Appl. No.: **29/244,388**

(22) Filed: **Dec. 8, 2005**

(51) **LOC (8) Cl.** ..... **12-11**

(52) **U.S. Cl.** ..... **D12/110**

(58) **Field of Classification Search** ..... D12/110;  
180/219, 220, 225, 229

See application file for complete search history.

(56) **References Cited**

**U.S. PATENT DOCUMENTS**

D401,891 S \* 12/1998 Fujieda ..... D12/110

**OTHER PUBLICATIONS**

Suzuki Nuda, circa 1987, on p. 1 of 7. [Retrieved on May 30, 2006]. Retrieved from the Internet <URL: [http://negaten-do.net/kmc/en\\_us\\_suzuki.htm](http://negaten-do.net/kmc/en_us_suzuki.htm)>.\*

\* cited by examiner

*Primary Examiner*—Alan P. Douglas

*Assistant Examiner*—Linda Brooks

(74) *Attorney, Agent, or Firm*—Baker & Daniels LLP

(57) **CLAIM**

We claim the ornamental design for the motorcycle, as shown and described.

**DESCRIPTION**

FIG. 1 is a perspective view of the motorcycle of the present design application;

FIGS. 2 and 3 show right side views of the motorcycle of FIG. 1;

FIG. 4 shows a left hand side view of the motorcycle of FIG. 1;

FIG. 5 shows a top view of the motorcycle of FIG. 1;

FIG. 6 shows a front view of the motorcycle of FIG. 1;

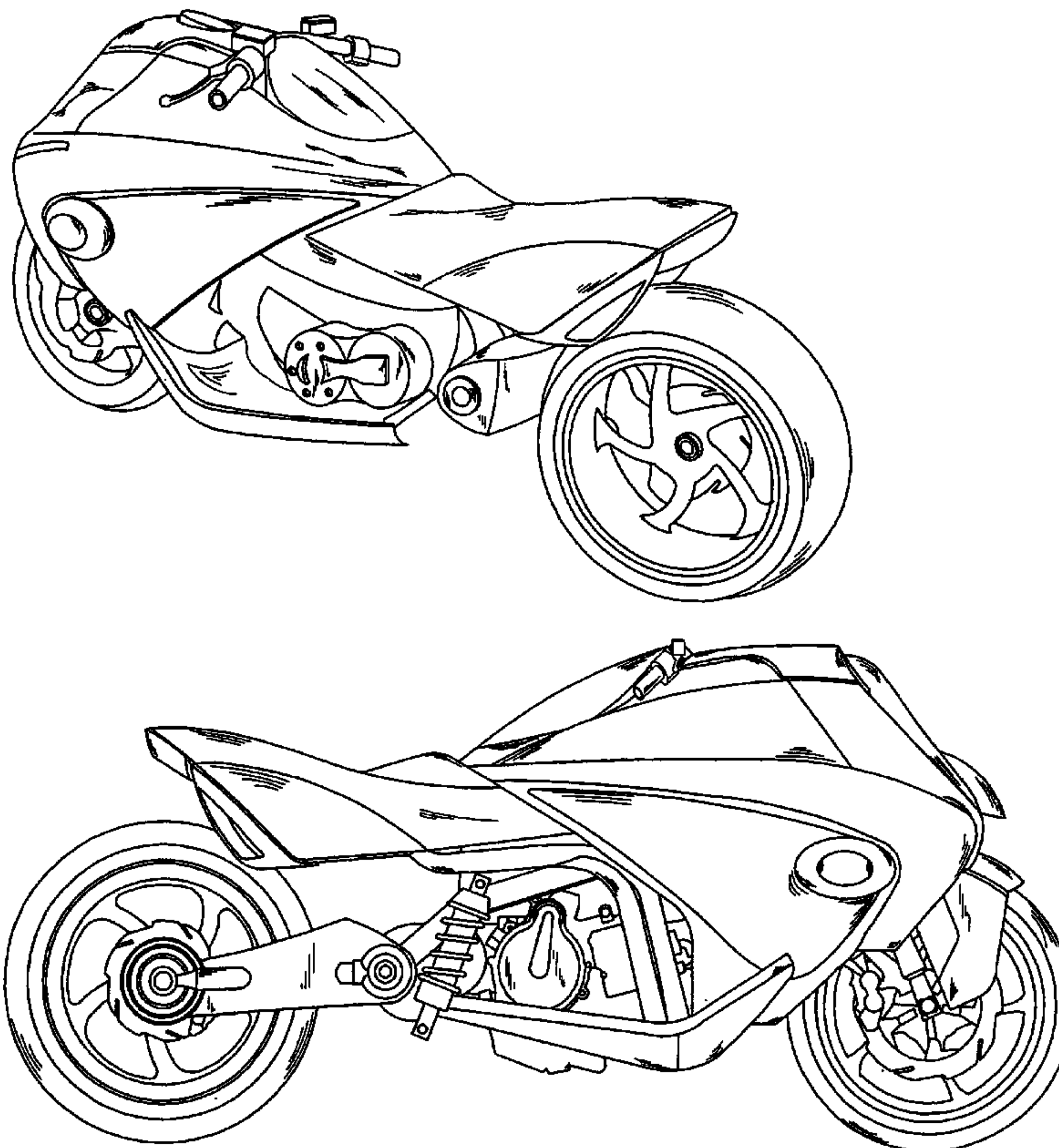
FIG. 7 shows a front plan view of the motorcycle of FIG. 1 with an upwardly looking perspective;

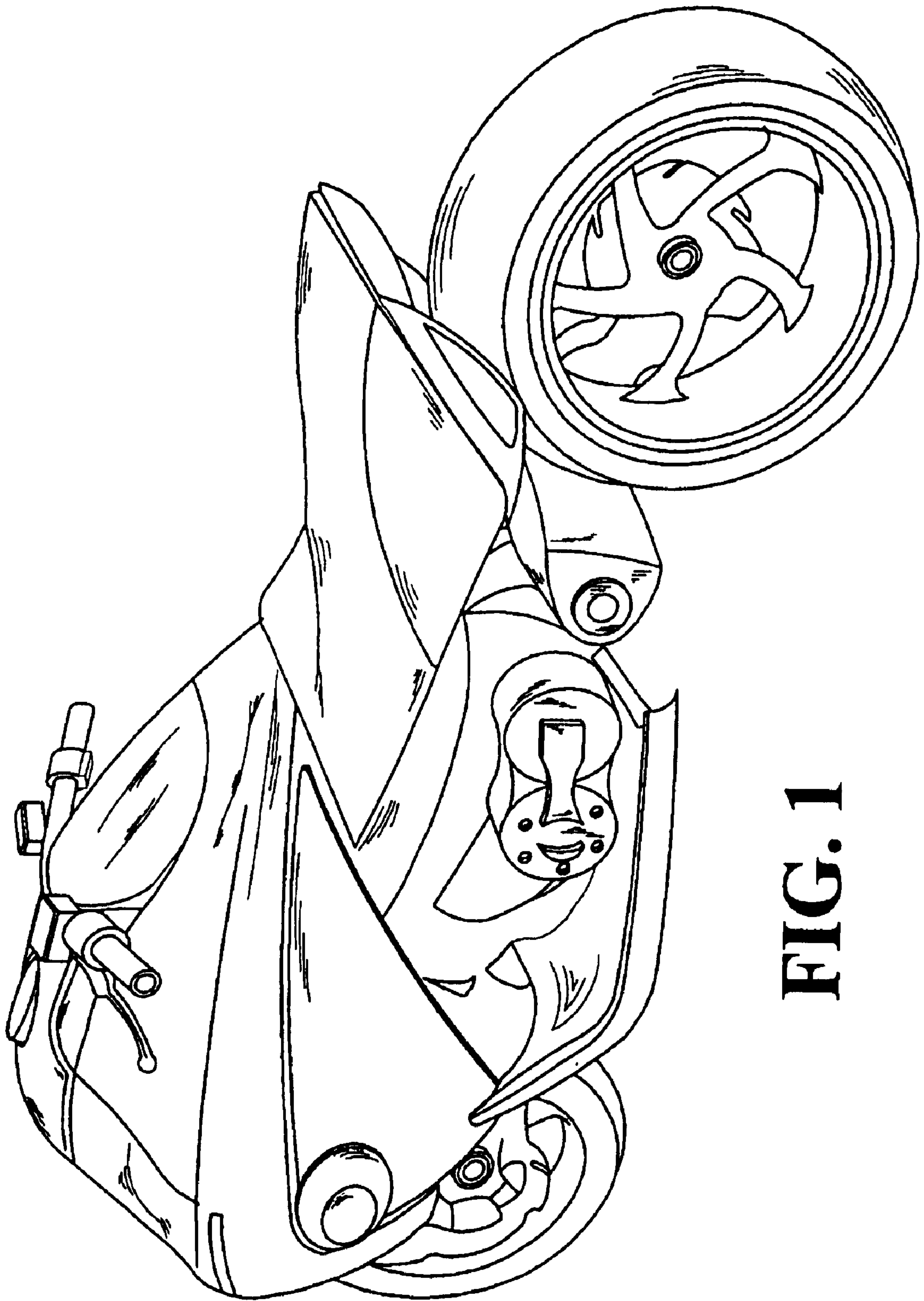
FIGS. 8 and 9 show rear views of the motorcycle of FIG. 1;

FIG. 10 shows a detailed view of the steering column and forward portion of the motorcycle of FIG. 1, shown separately for clarity; and,

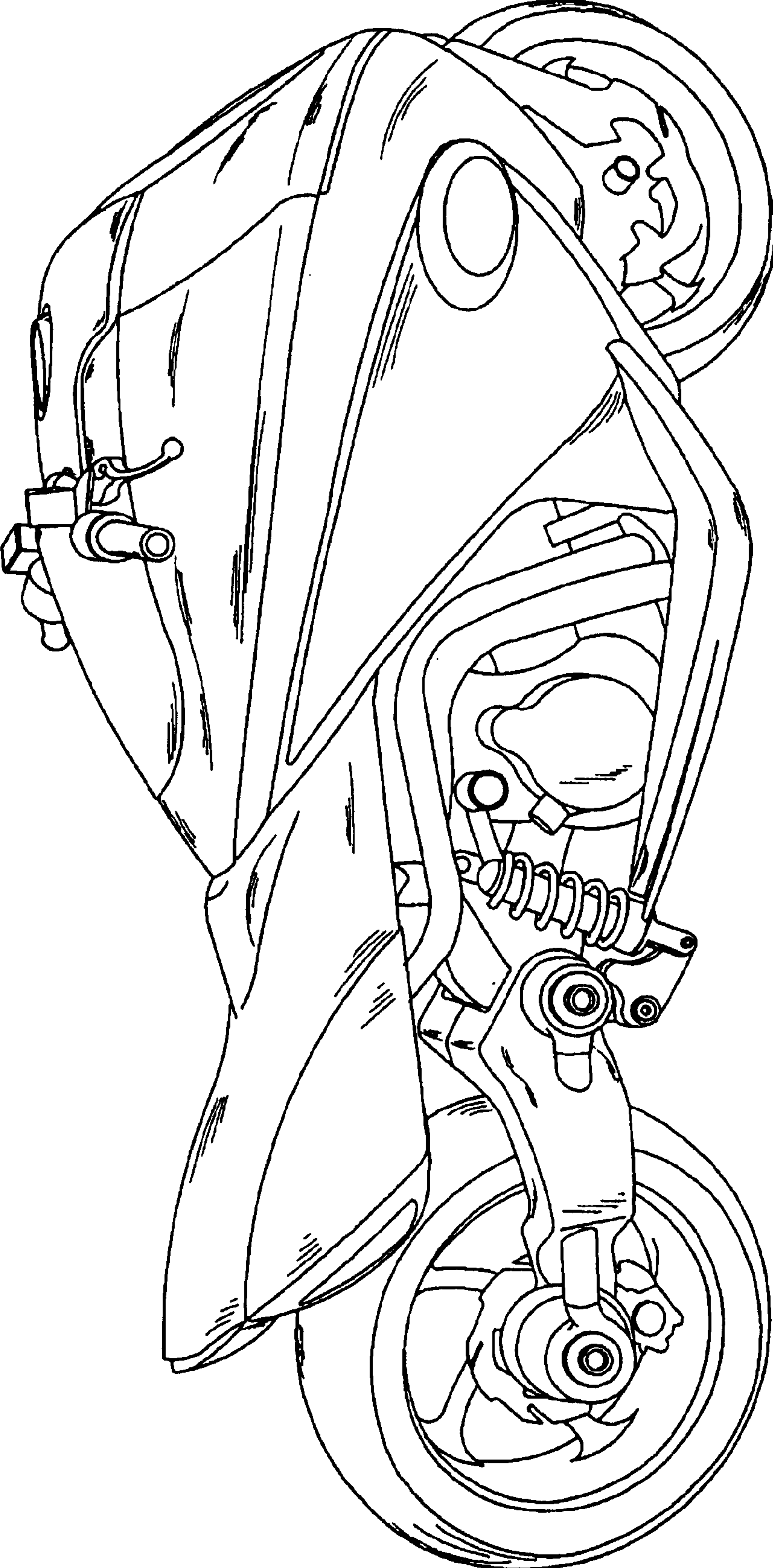
FIG. 11 shows a detailed view of the seating portion of the motorcycle of FIG. 1, shown separately for clarity.

**1 Claim, 9 Drawing Sheets**



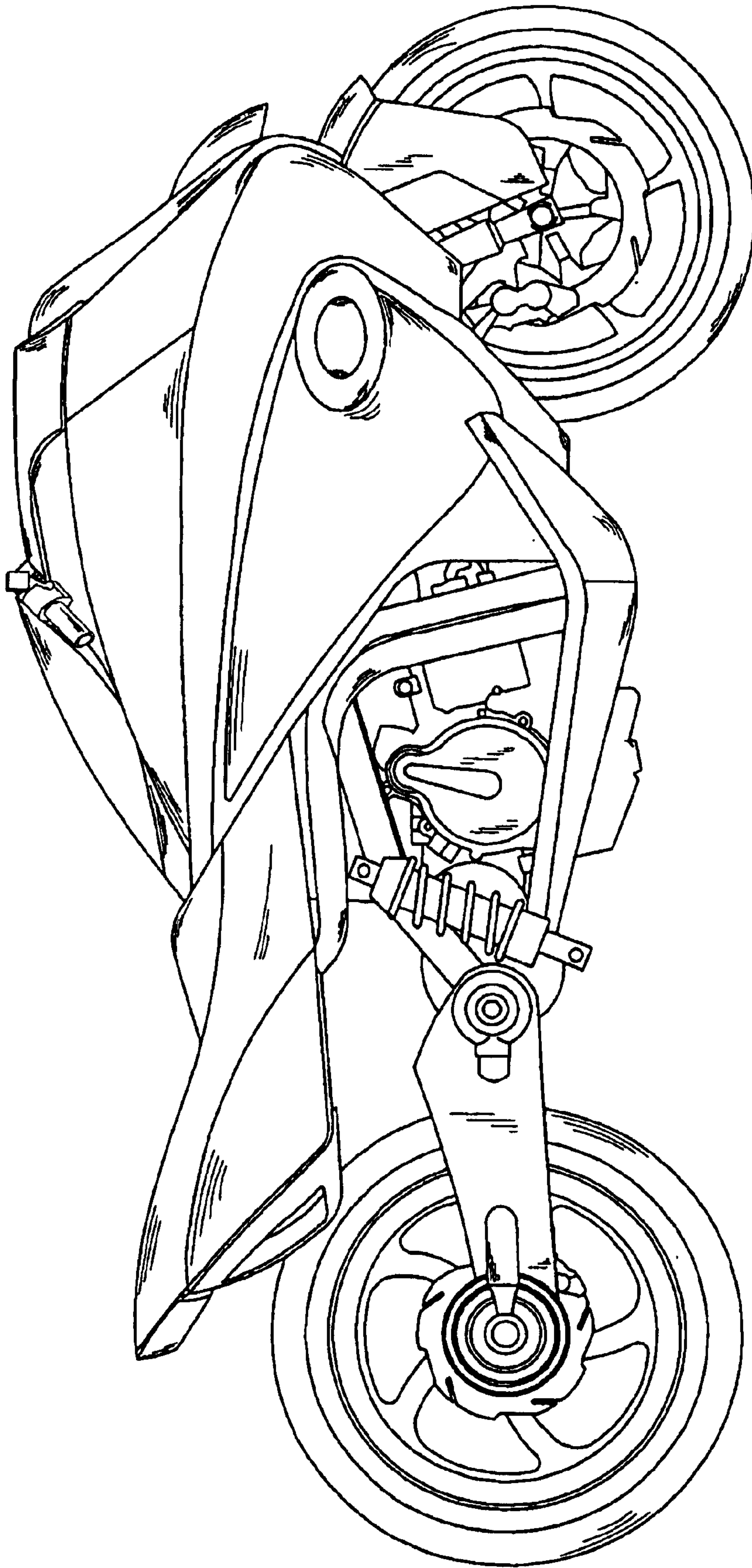


**FIG. 1**

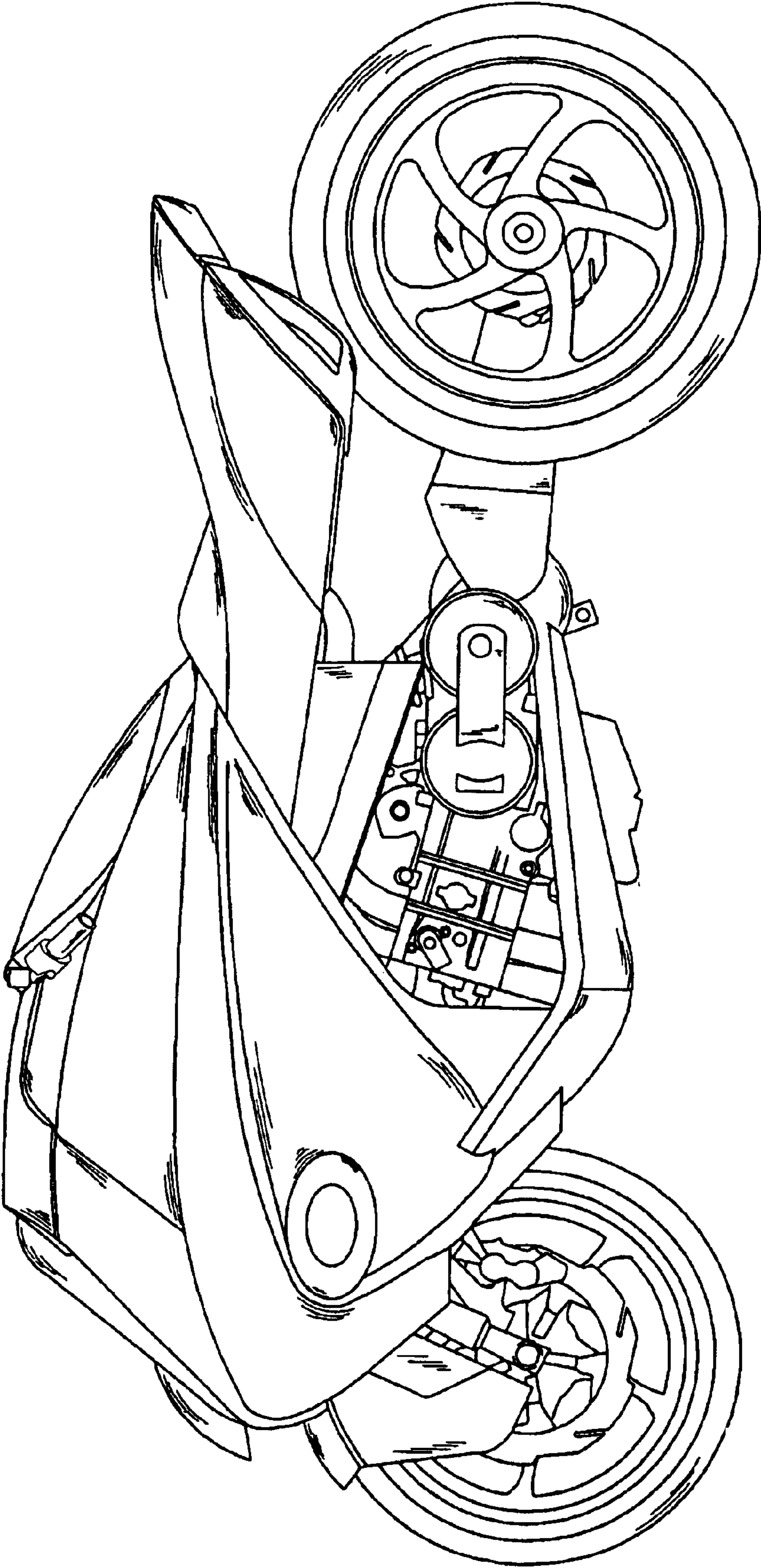


**FIG. 2**





**FIG. 3**



**FIG. 4**

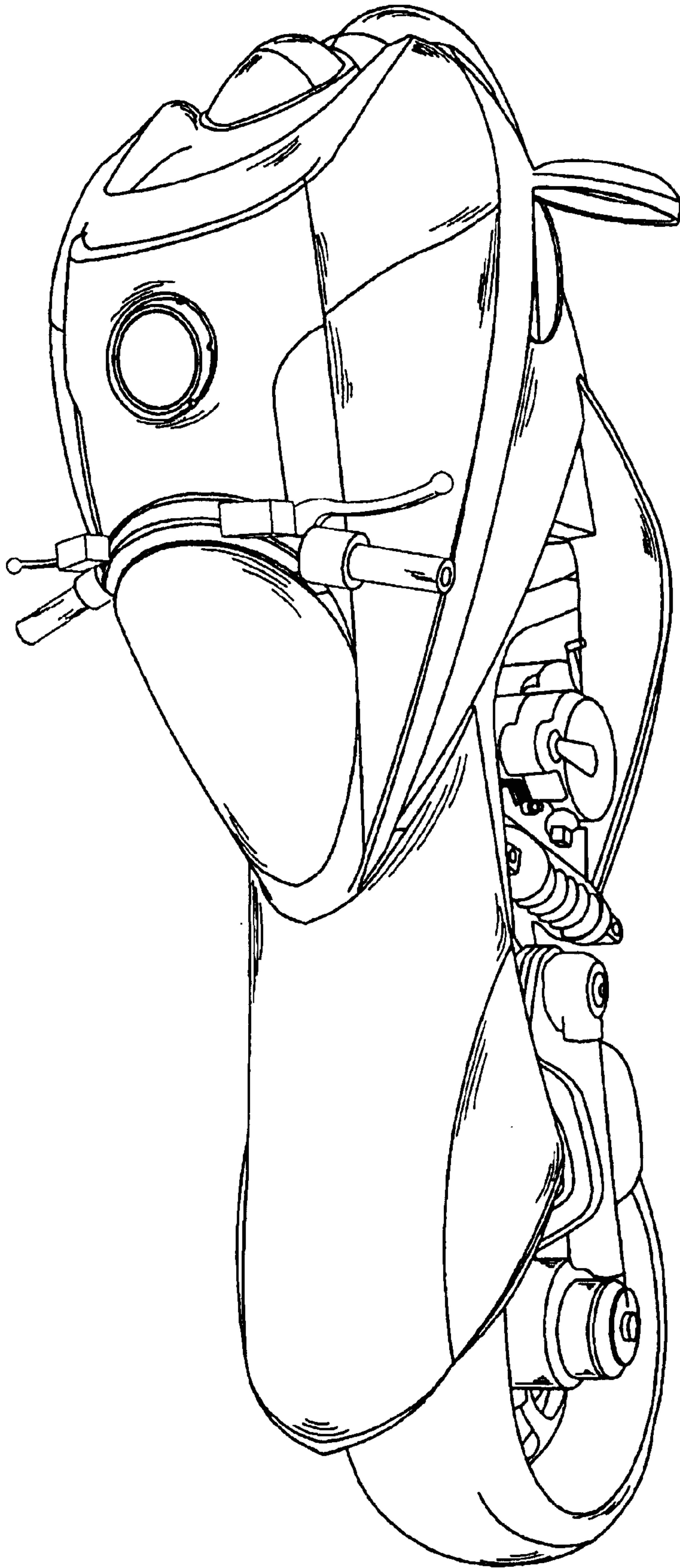
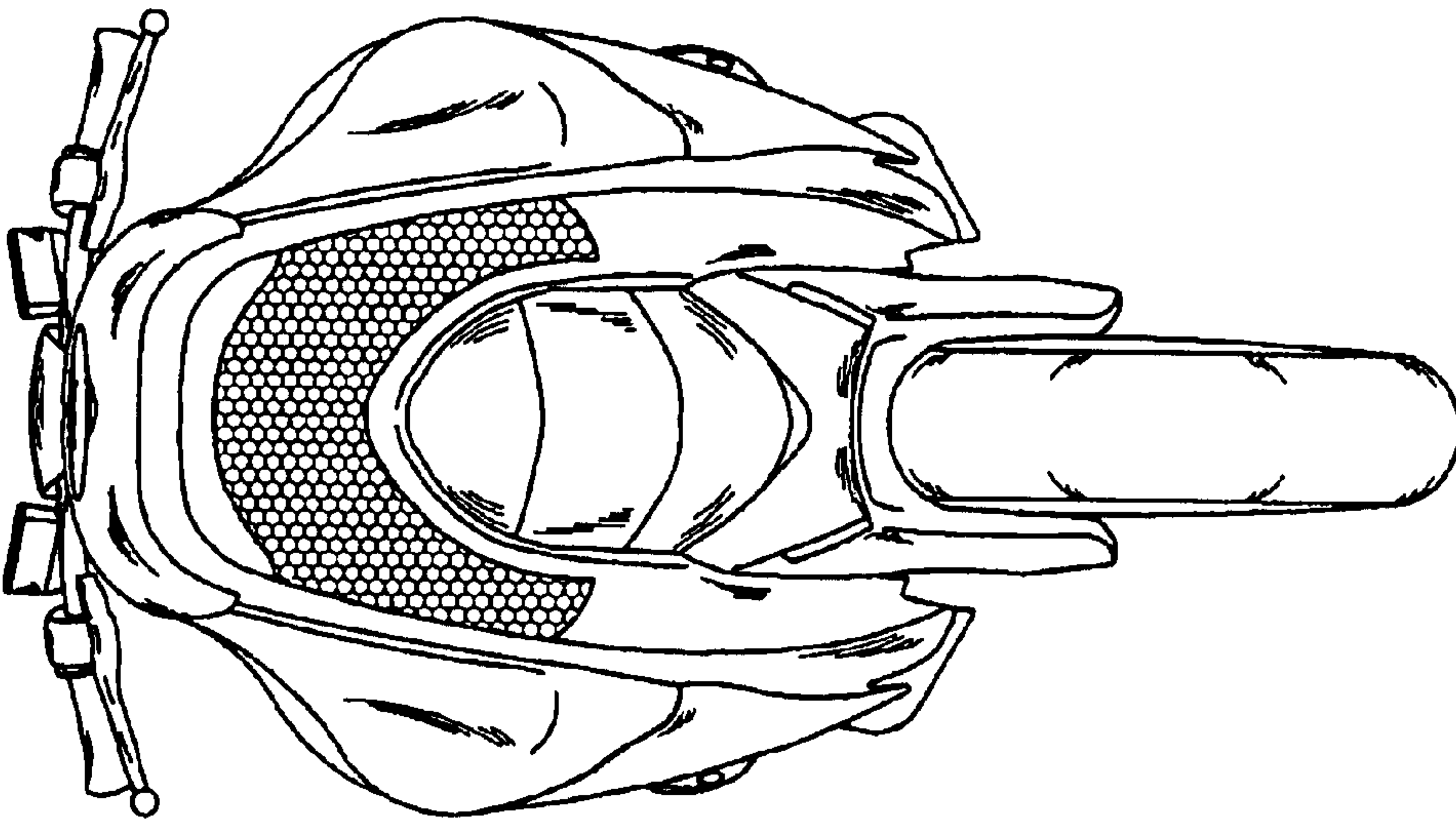
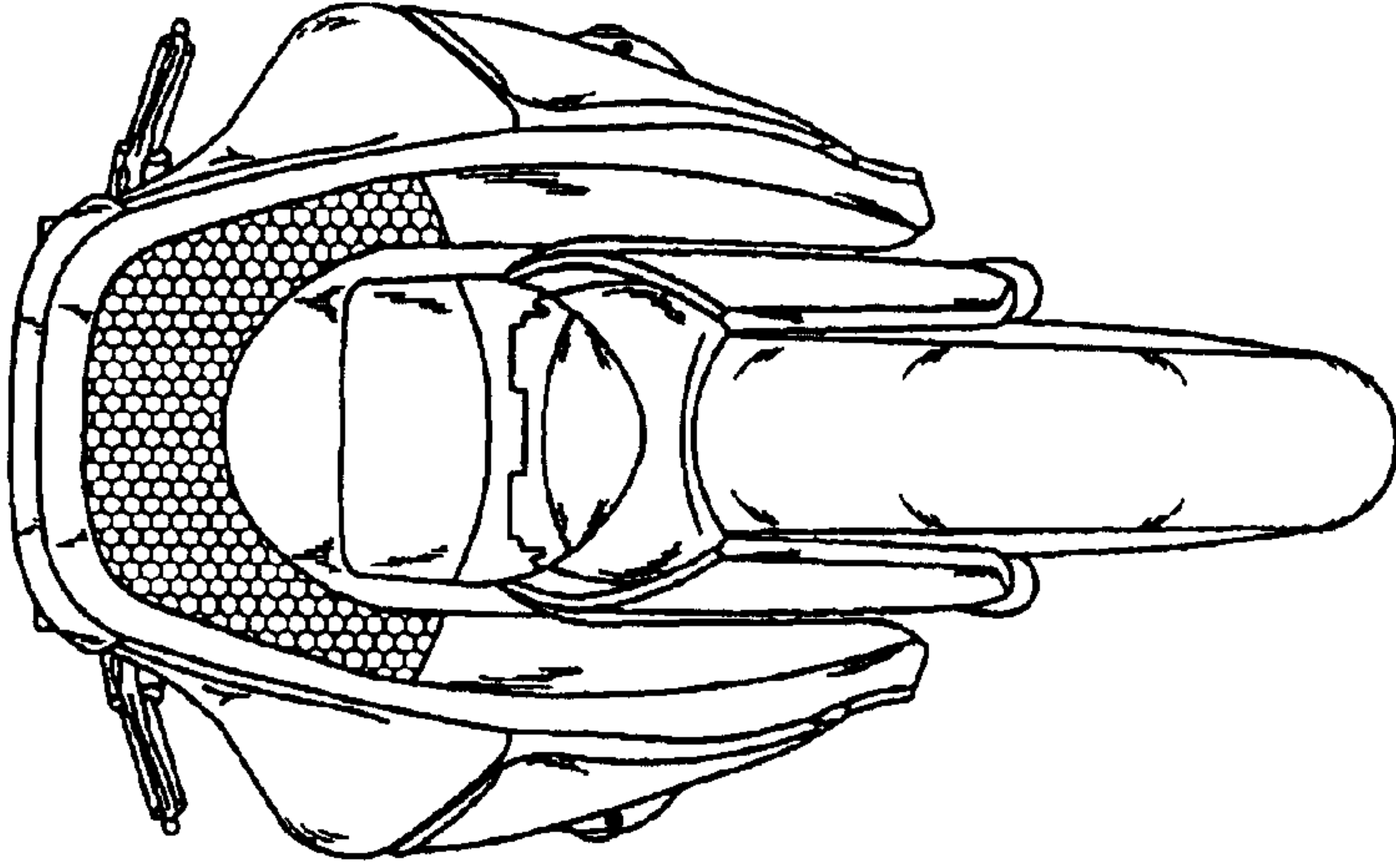


FIG. 5





**FIG. 6**



**FIG. 7**

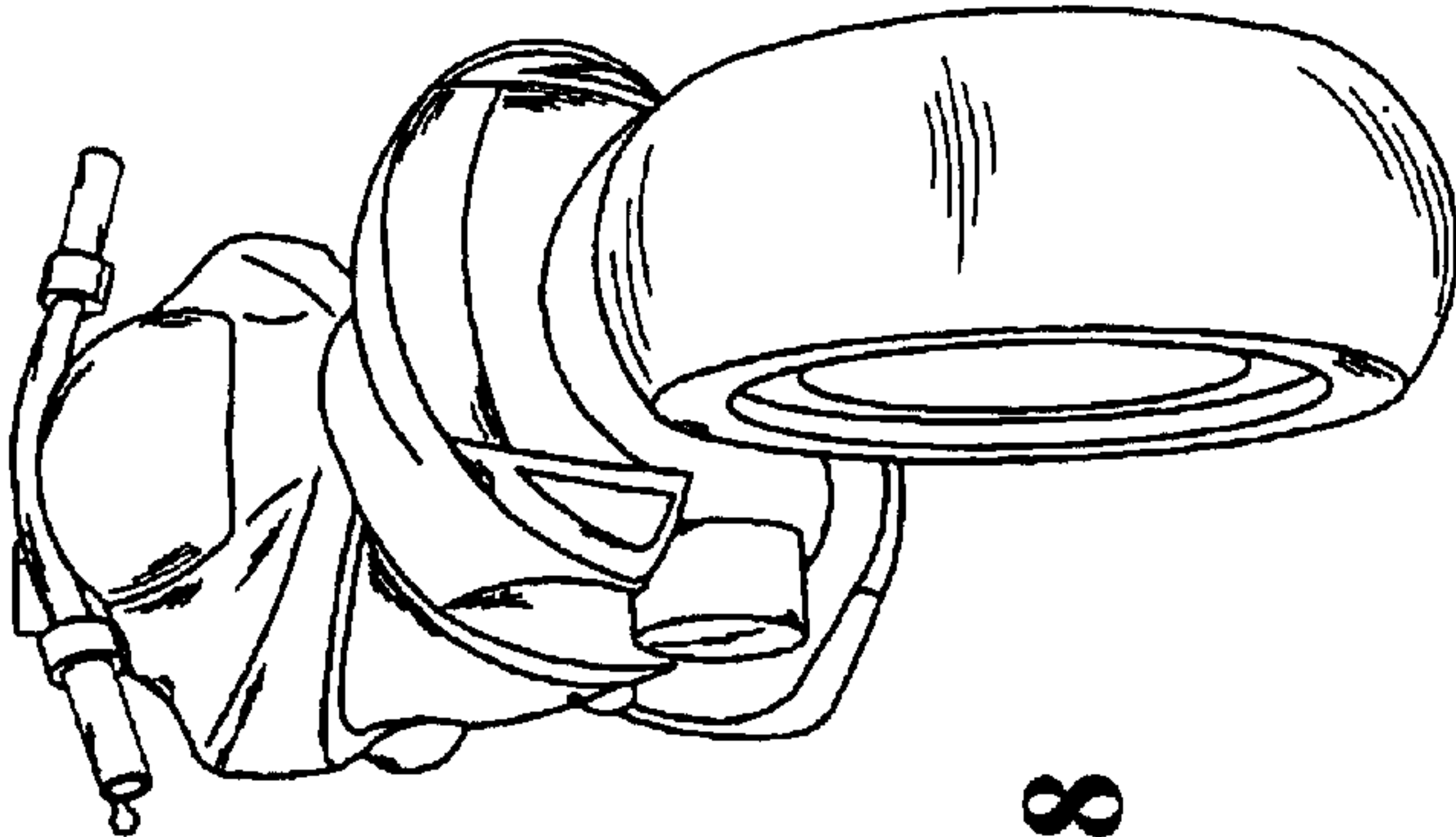


FIG. 8

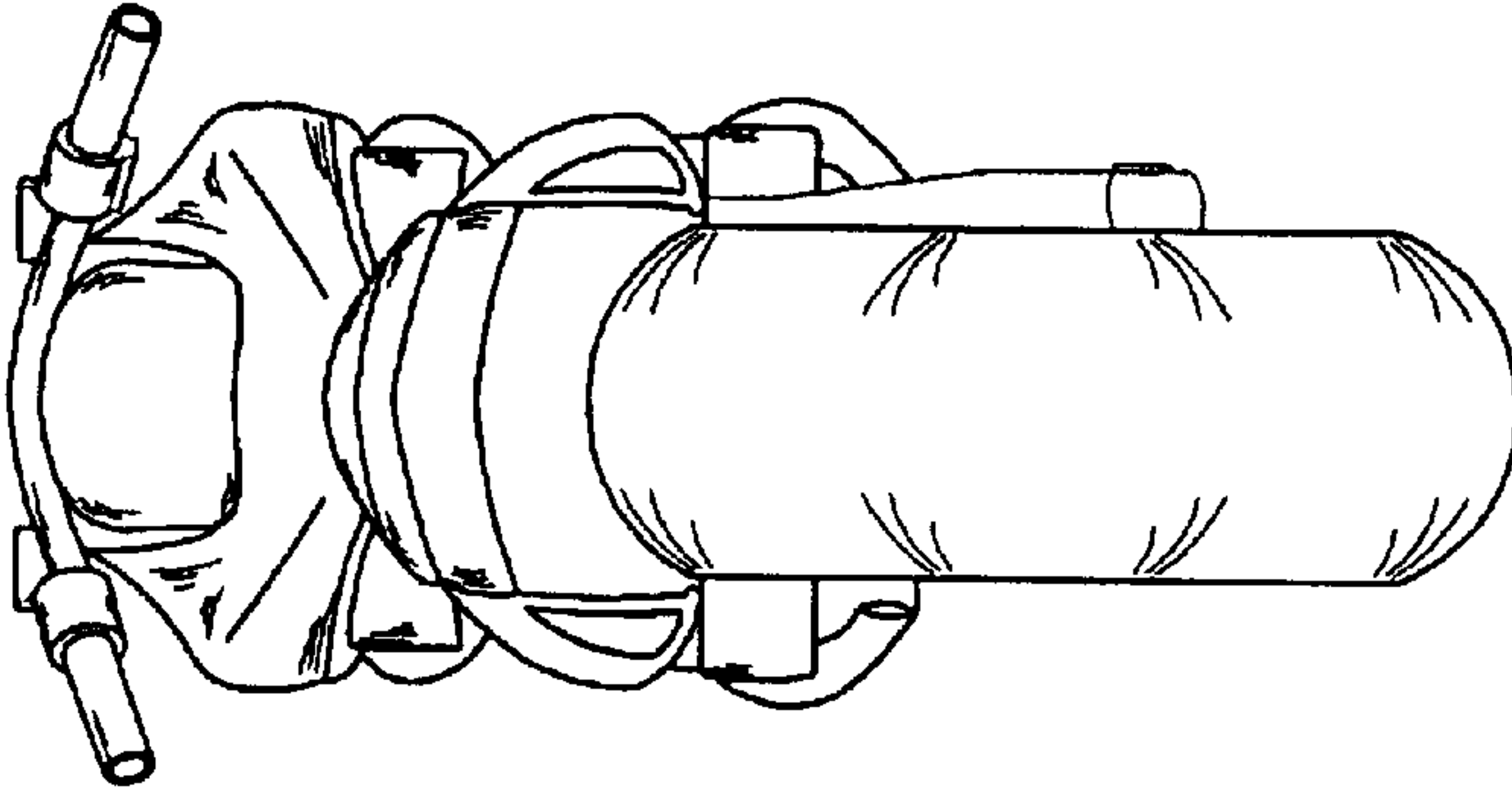
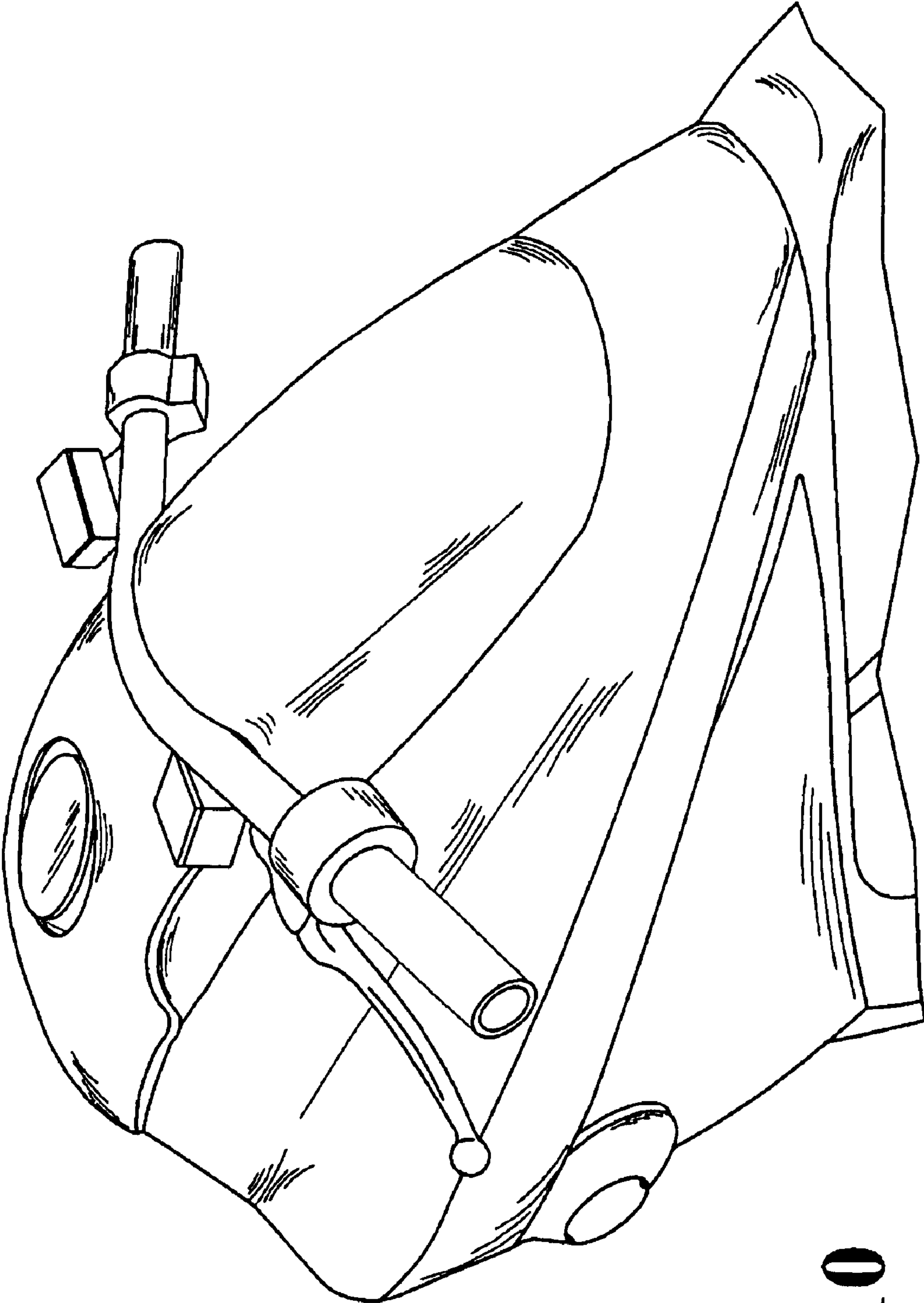
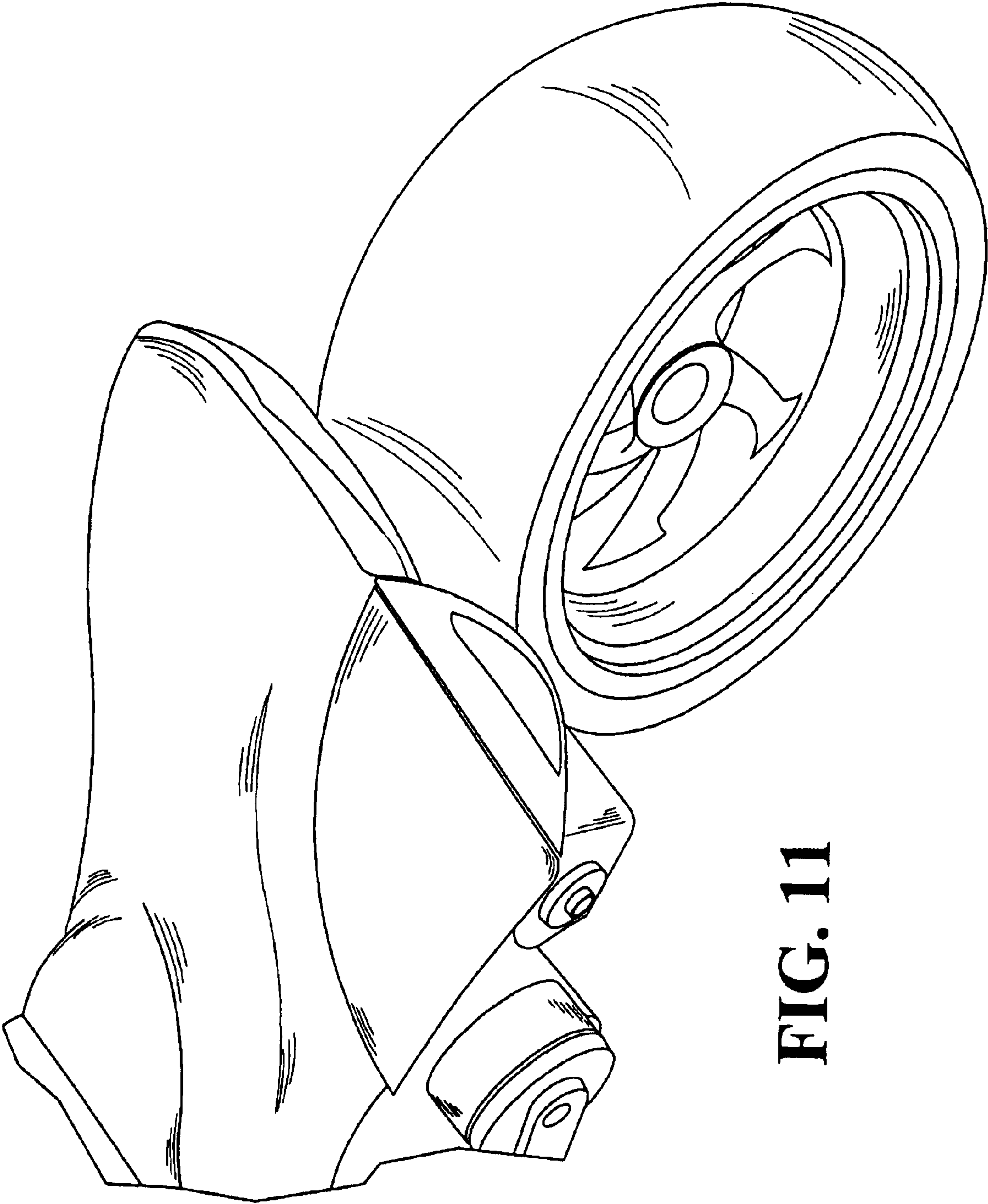


FIG. 9





**FIG. 10**



**FIG. 11**