



US00D541063S

(12) **United States Design Patent** (10) **Patent No.:** **US D541,063 S**
Su (45) **Date of Patent:** **** Apr. 24, 2007**

(54) **OFFICE CHAIR**

(76) Inventor: **Shu O Su**, No. 63, Lane 128, Beicheng Rd., Tainan City (TW)

(**) Term: **14 Years**

(21) Appl. No.: **29/258,094**

(22) Filed: **Apr. 14, 2006**

(51) **LOC (8) Cl.** **06-01**

(52) **U.S. Cl.** **D6/366**

(58) **Field of Classification Search** D6/334-336,
D6/364, 365, 366, 367, 379, 380, 498, 500-502;
297/411.2, 411.27, 411.36, 452.29, 452.3,
297/452.64; 248/188.7

See application file for complete search history.

(56) **References Cited**

U.S. PATENT DOCUMENTS

D449,174 S	*	10/2001	Neil	D6/366
D451,293 S	*	12/2001	Su	D6/366
D474,346 S	*	5/2003	Saylor et al.	D6/366
D477,151 S	*	7/2003	Koepke et al.	D6/366
D487,359 S	*	3/2004	Giugiaro	D6/366
D489,191 S	*	5/2004	Ma	D6/366

D493,626 S	*	8/2004	James	D6/366
D493,627 S	*	8/2004	Ma	D6/366
D500,218 S	*	12/2004	Koepke et al.	D6/501
D511,418 S	*	11/2005	Breen	D6/366
D514,832 S	*	2/2006	Tsai	D6/366
D527,920 S	*	9/2006	Giugiaro	D6/366
D528,811 S	*	9/2006	Giugiaro	D6/366

* cited by examiner

Primary Examiner—Mimosa De

(74) *Attorney, Agent, or Firm*—Pro-Techtor Int'l Services

(57) **CLAIM**

The ornamental design for a office chair, as shown and described.

DESCRIPTION

FIG. 1 is a perspective view of a office chair showing my new design;

FIG. 2 is a front view of the design;

FIG. 3 is a rear view of the design;

FIG. 4 is a left side view of the design;

FIG. 5 is a right side view of the design;

FIG. 6 is a top view of the design; and,

FIG. 7 is a bottom view of the design.

1 Claim, 4 Drawing Sheets

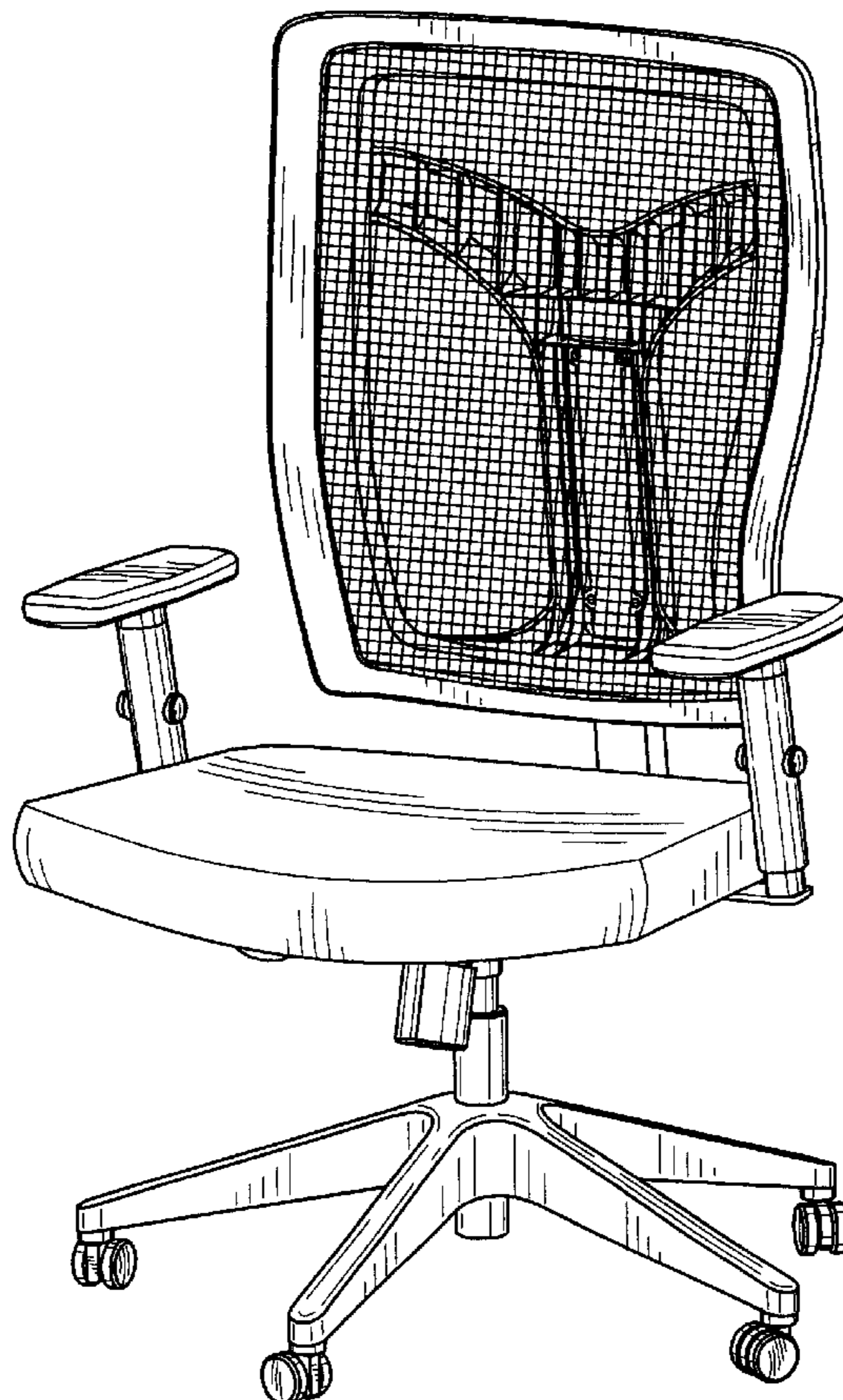

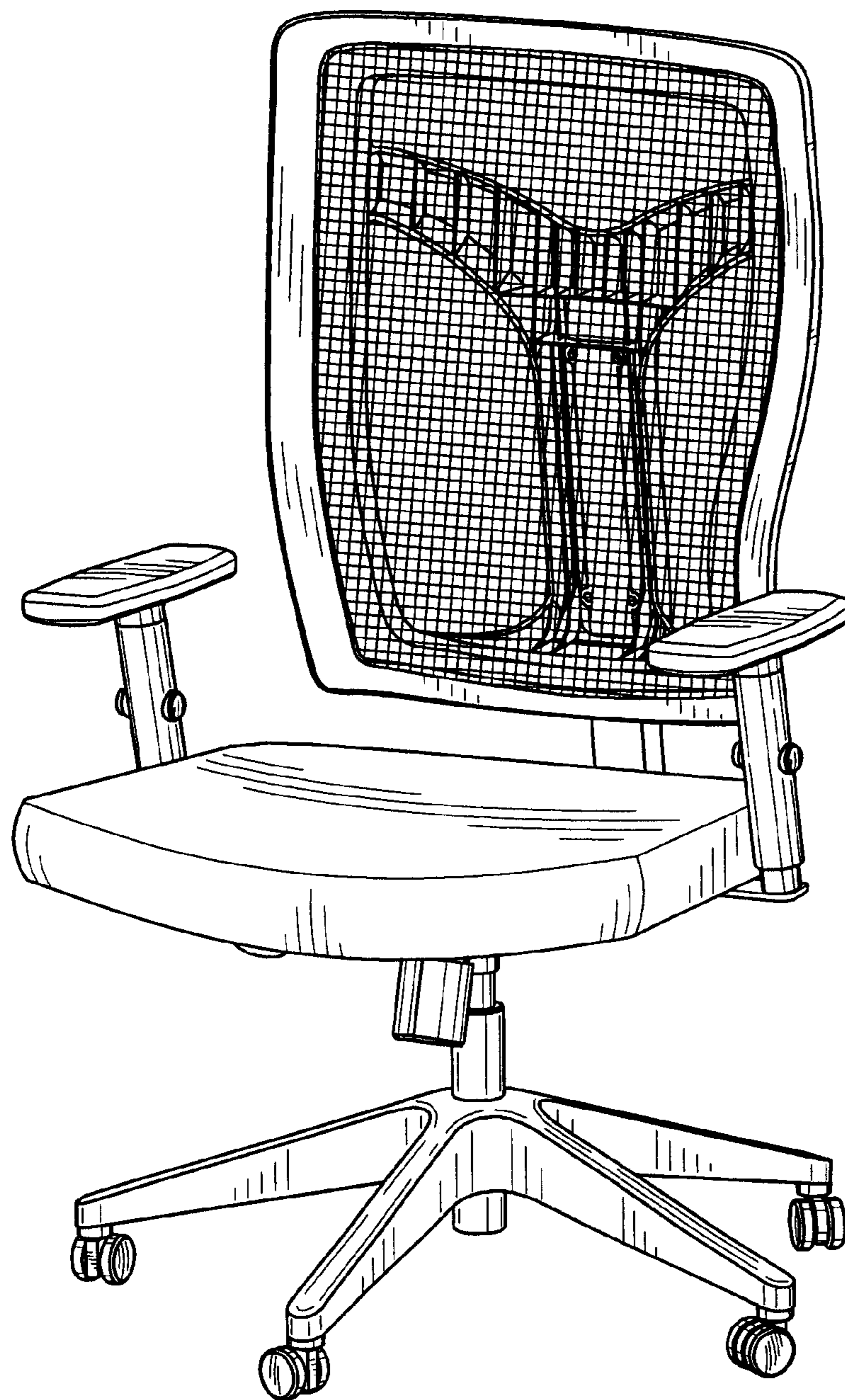

FIG. 1

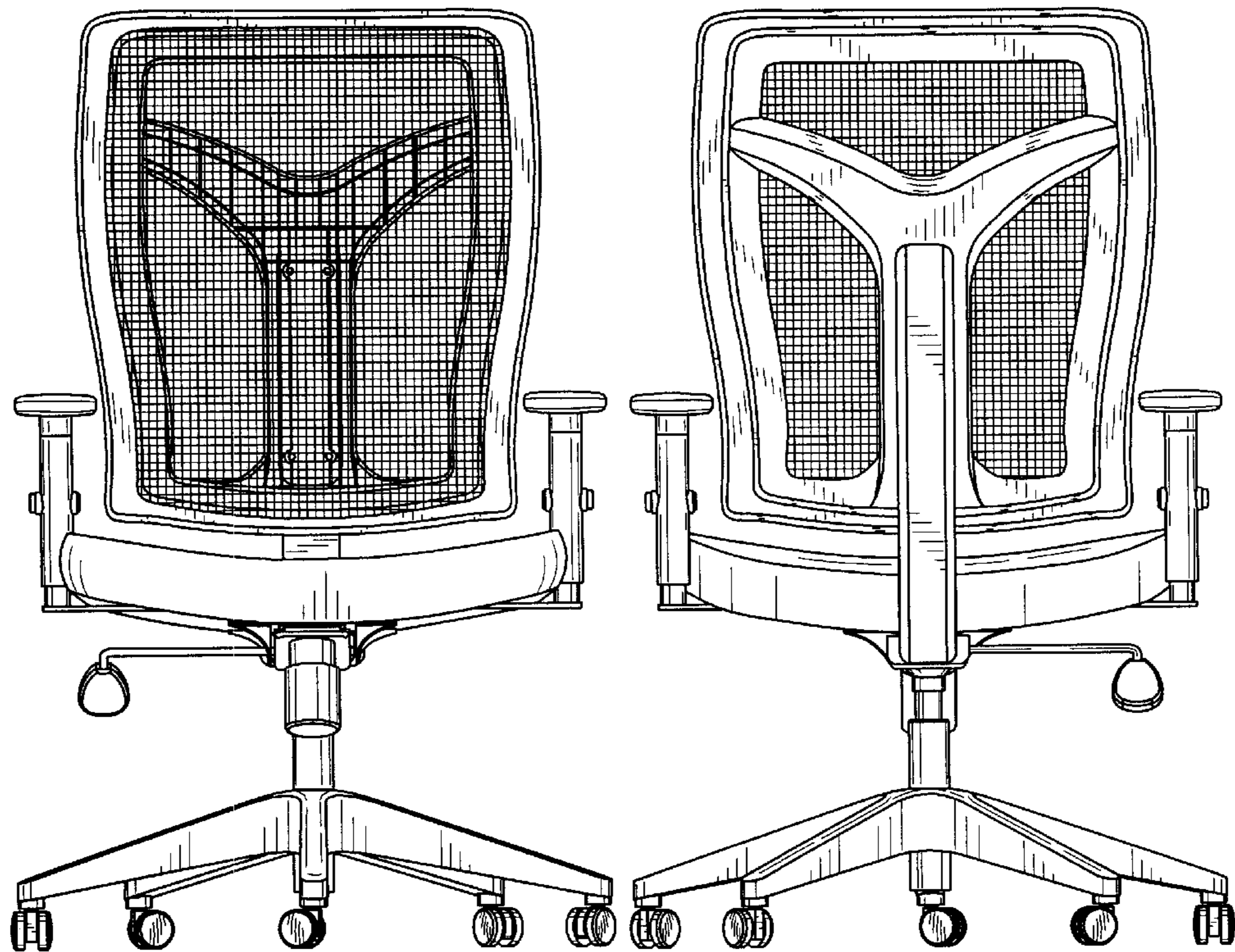

FIG. 2

FIG. 3

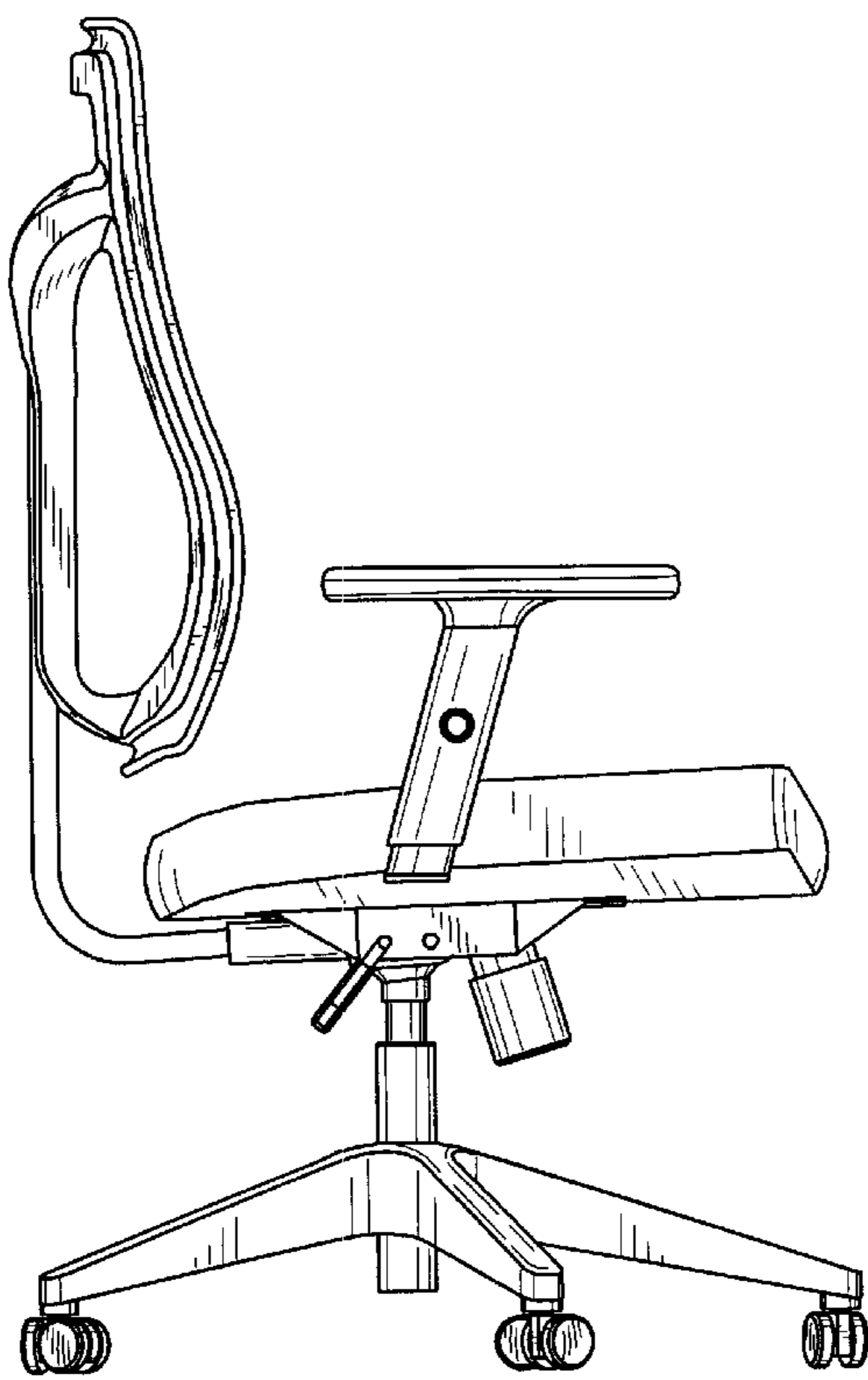

FIG. 4

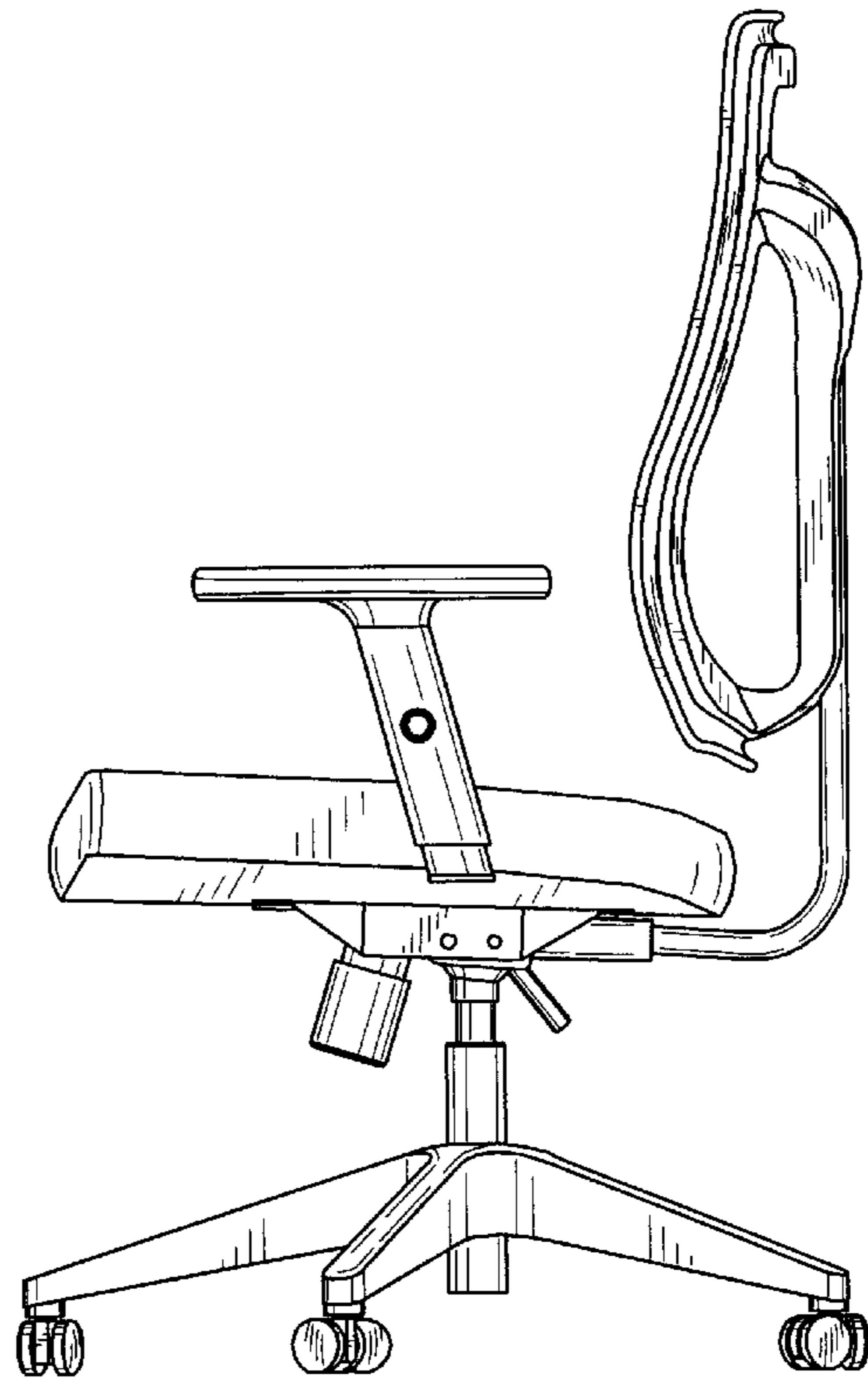

FIG. 5

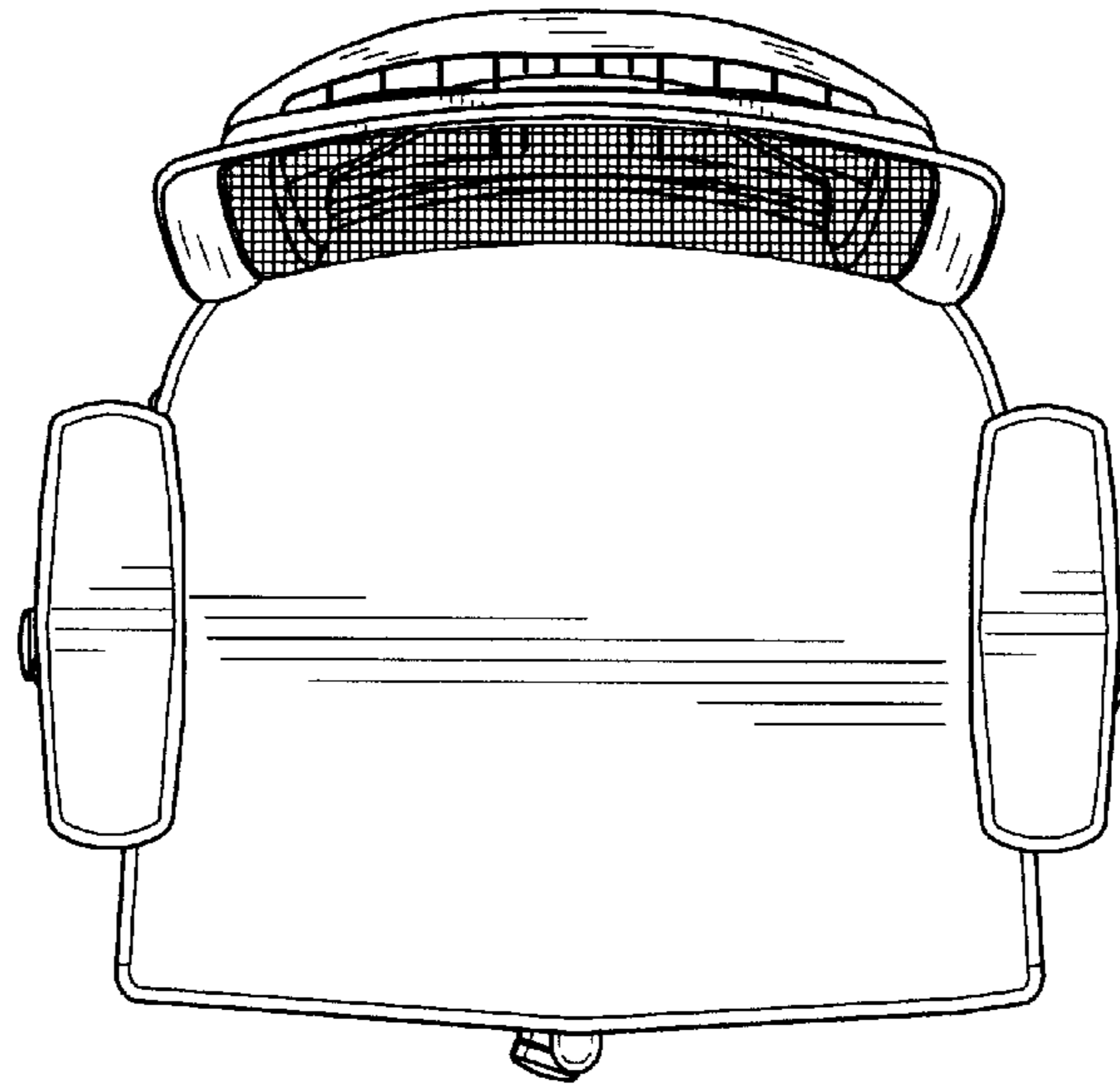

FIG. 6

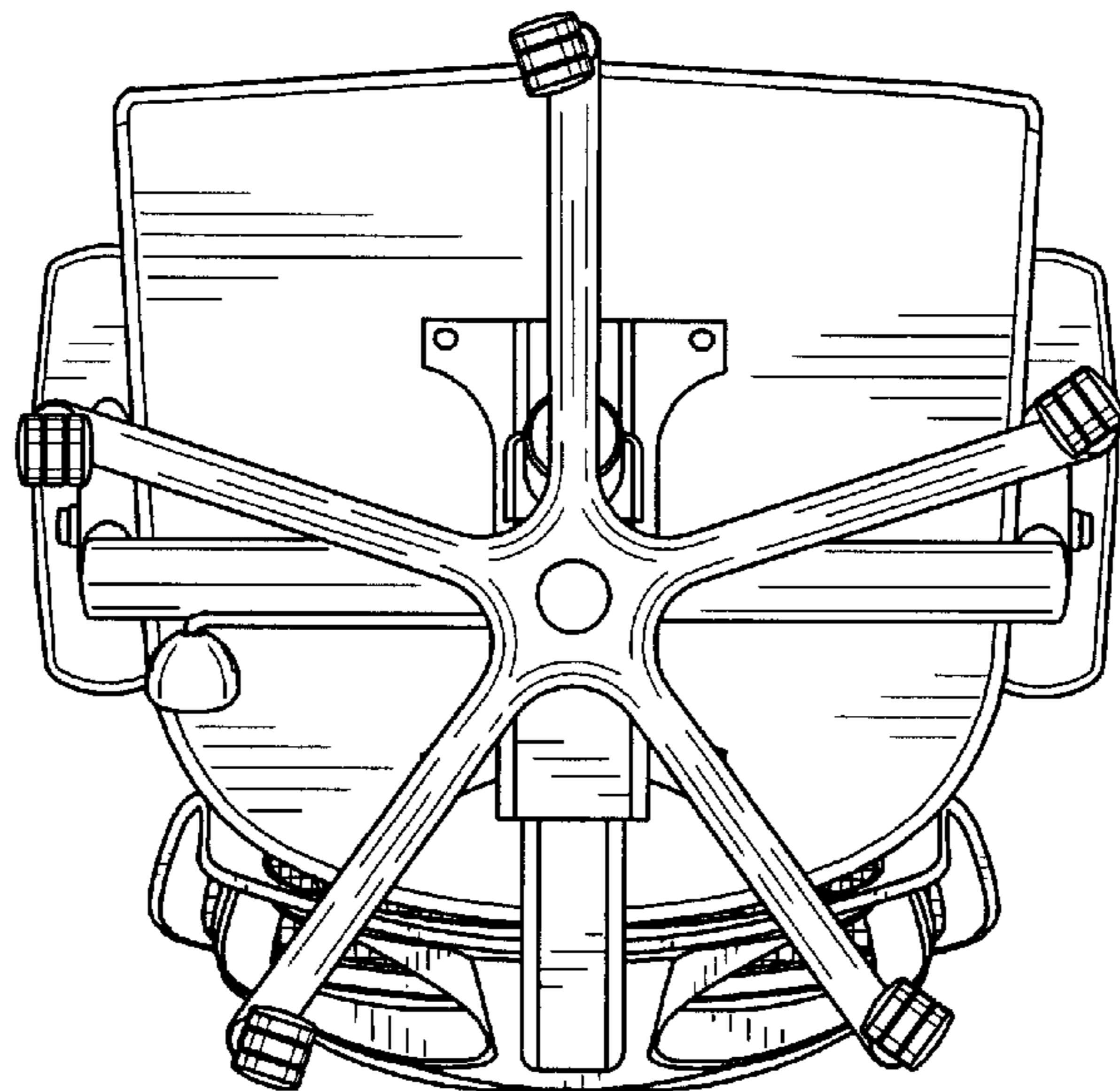

FIG. 7