

US00D541061S

(12) **United States Design Patent**  
**Benden et al.**

(10) **Patent No.:** **US D541,061 S**  
(45) **Date of Patent:** **\*\* Apr. 24, 2007**

(54) **SEATING DEVICE**

(75) Inventors: **Mark E. Benden**, College Station, TX (US); **Anthony K. Chapman**, Temple, TX (US); **Maria R. Sanchez**, Bryan, TX (US)

(73) Assignee: **Neutral Posture, Inc.**, Bryan, TX (US)

(\*\*) Term: **14 Years**

(21) Appl. No.: **29/231,922**

(22) Filed: **Jun. 10, 2005**

(51) **LOC (8) Cl.** ..... **06-01**

(52) **U.S. Cl.** ..... **D6/366**

(58) **Field of Classification Search** ..... D6/334-335, D6/364, 365, 366, 367, 368, 498, 500-502; 297/411.2, 411.27, 411.28, 452.37, 452.48

See application file for complete search history.

(56) **References Cited**

**U.S. PATENT DOCUMENTS**

D395,762 S	*	7/1998	Saul	.....	D6/366
5,961,134 A		10/1999	Congleton et al.	.....	280/47.18
D427,793 S	*	7/2000	Groulx et al.	.....	D6/366
6,142,571 A		11/2000	Benden	.....	297/423.4
D436,768 S	*	1/2001	Jenkins et al.	.....	D6/500
6,220,663 B1		4/2001	Benden et al.	.....	297/284.6
D445,579 S	*	7/2001	Olson	.....	D6/366
D446,396 S	*	8/2001	Phillips et al.	.....	D6/366

6,290,295 B1		9/2001	Benden et al.	.....	297/284.6
6,296,312 B1		10/2001	Congleton et al.	.....	297/411.35
D458,777 S		6/2002	Benden et al.	.....	D6/500
D463,441 S		9/2002	Benden et al.	.....	D14/457
D473,726 S	*	4/2003	Schaefer et al.	.....	D6/366
D474,051 S	*	5/2003	Tseng	.....	D6/500
D474,052 S	*	5/2003	True	.....	D6/501
6,604,786 B1		8/2003	Benden et al.	.....	297/188.06
6,607,246 B1		8/2003	Benden	.....	297/423.4
D496,535 S	*	9/2004	Goodworth	.....	D6/366
6,877,812 B2		4/2005	Congleton et al.	.....	297/353

\* cited by examiner

*Primary Examiner*—Mimosa De

(74) *Attorney, Agent, or Firm*—Howrey LLP

(57) **CLAIM**

The ornamental design for a seating device, as shown and described.

**DESCRIPTION**

FIG. 1 is a front, right-side perspective view of a seating device showing our new design;

FIG. 2 a front elevational view thereof;

FIG. 3 is a rear elevational view thereof;

FIG. 4 is a right side elevational view thereof;

FIG. 5 is a left side elevational view thereof;

FIG. 6 is a top plan view thereof; and,

FIG. 7 is a bottom plan view thereof.

**1 Claim, 4 Drawing Sheets**

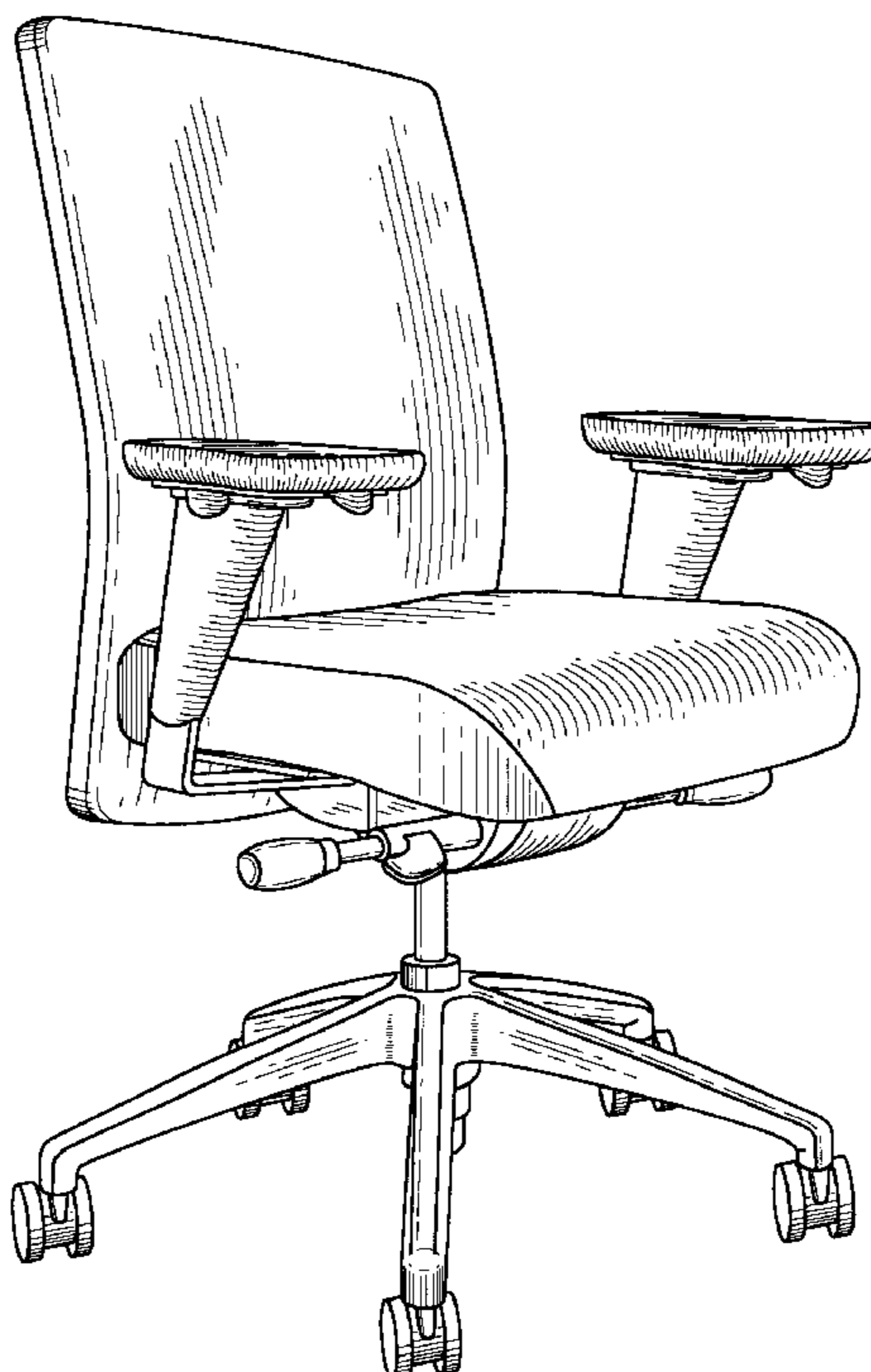

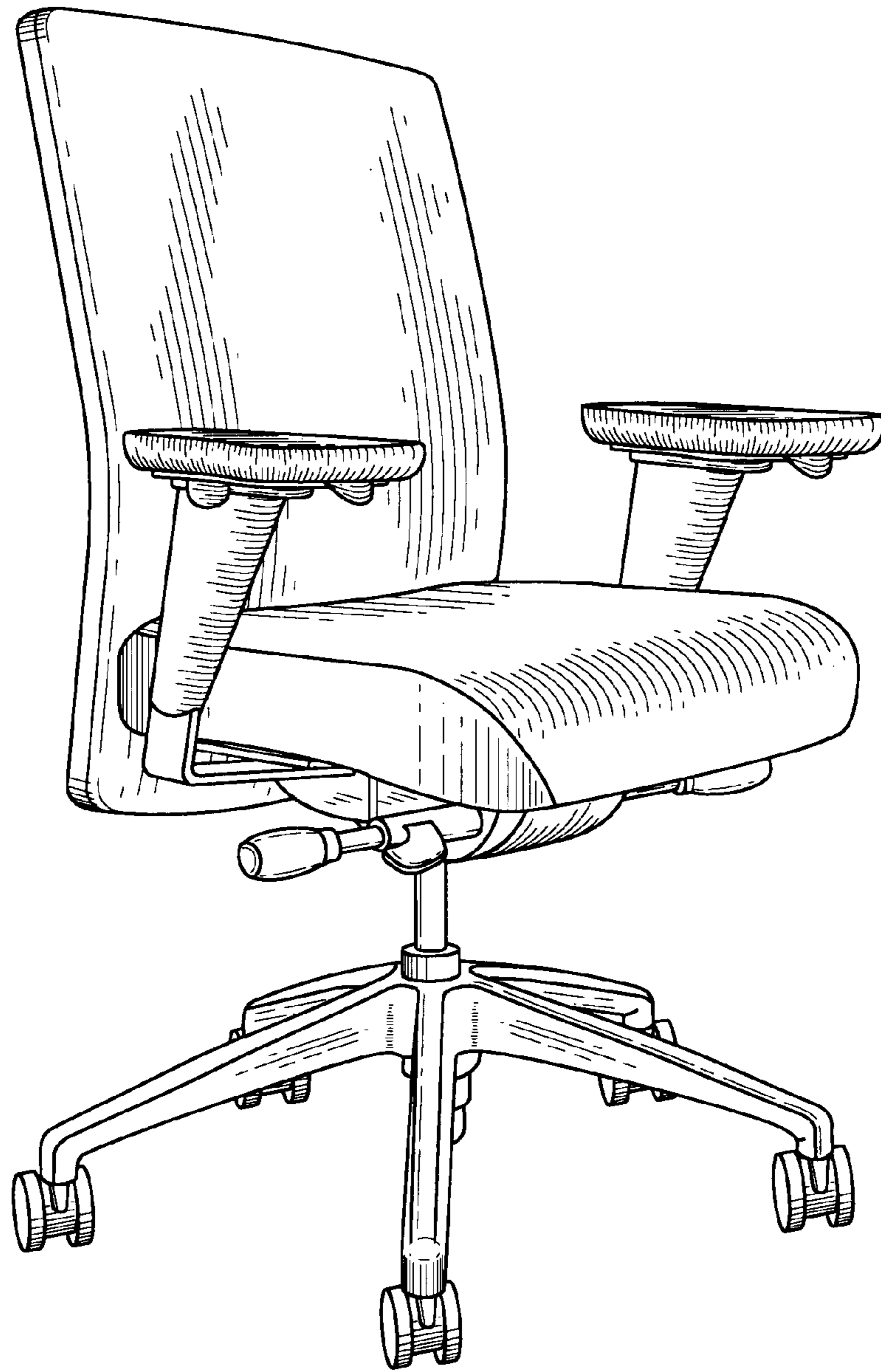

FIG. 1

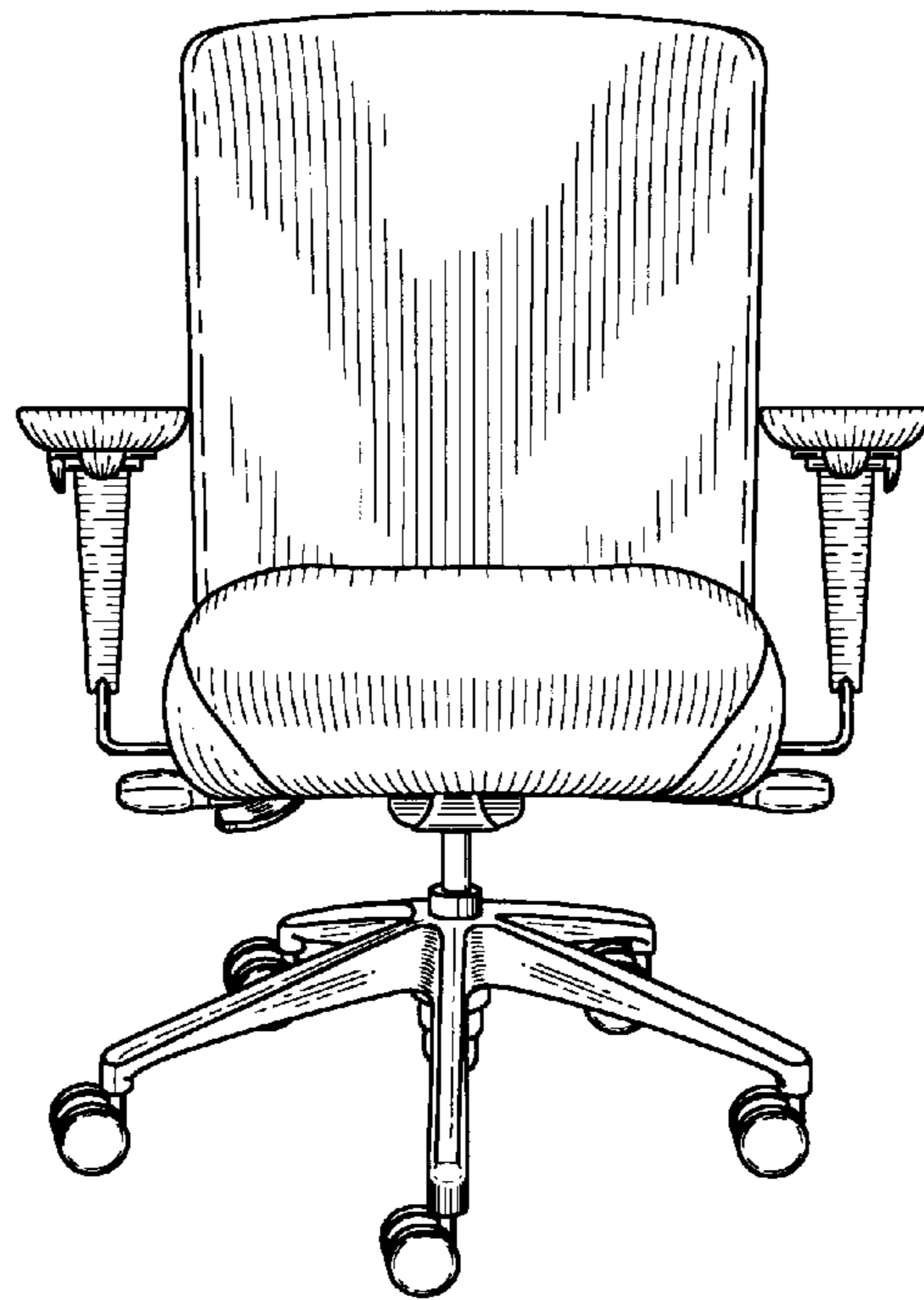

FIG. 2

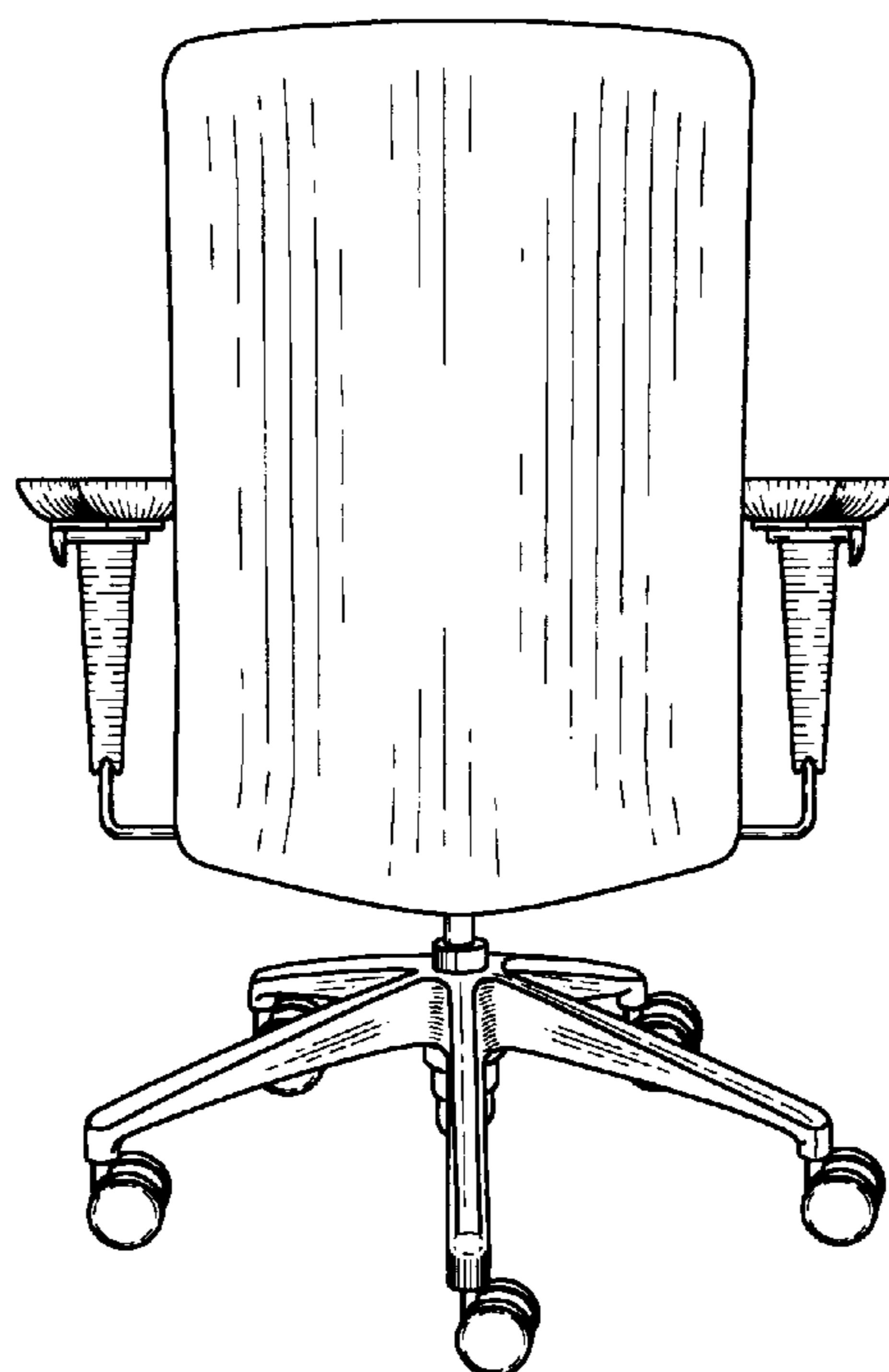

FIG. 3

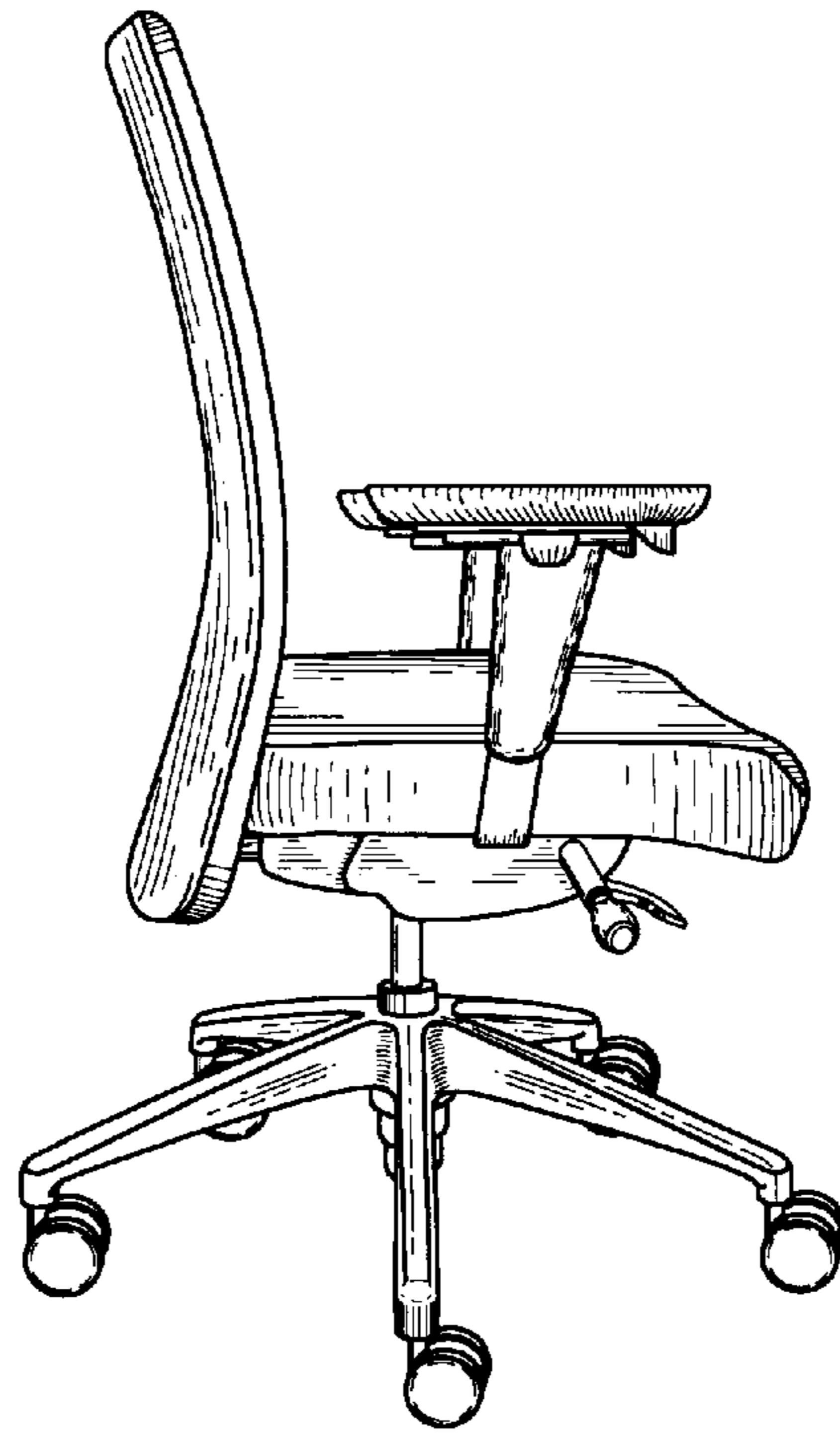

FIG. 4



FIG. 5

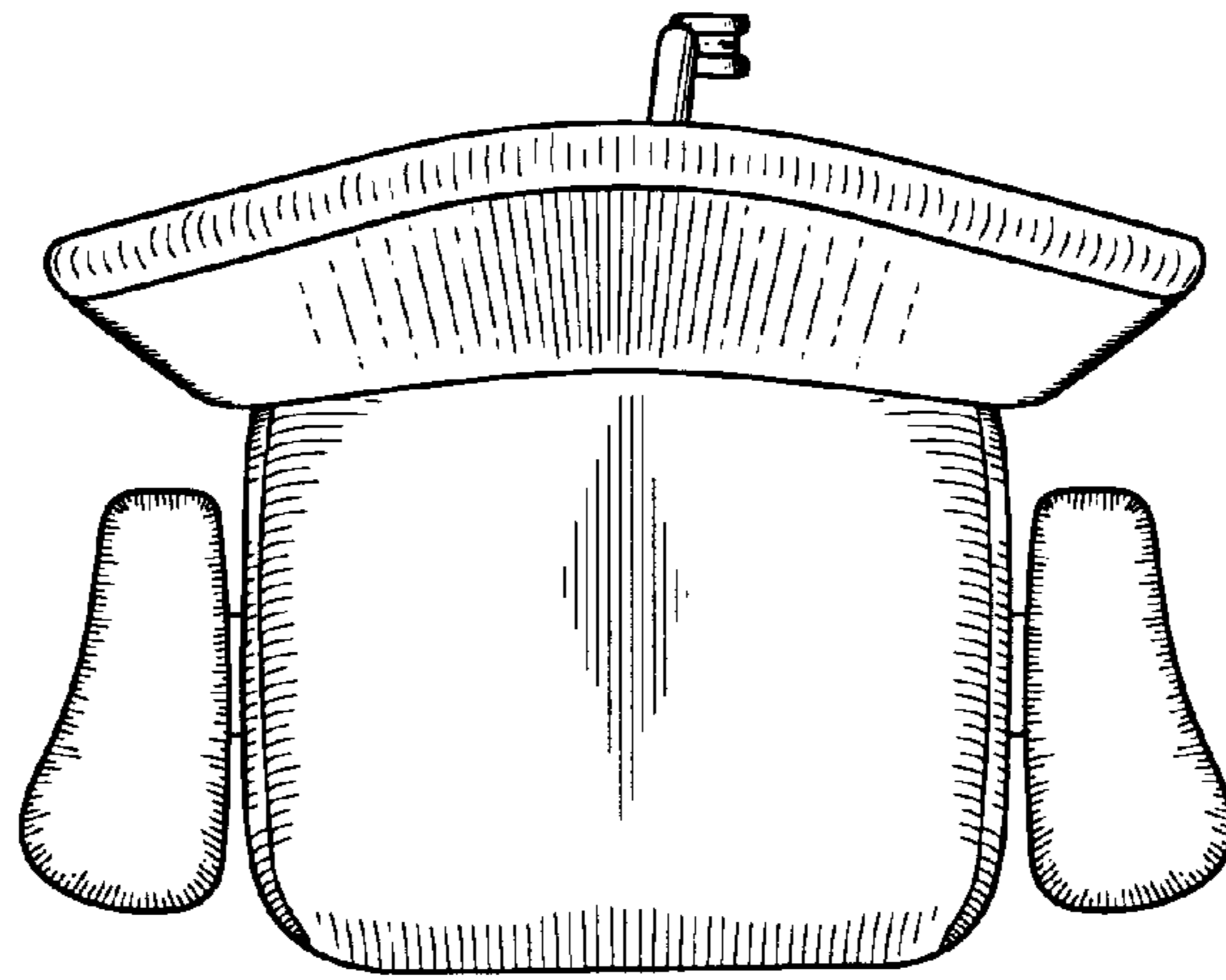

FIG. 6

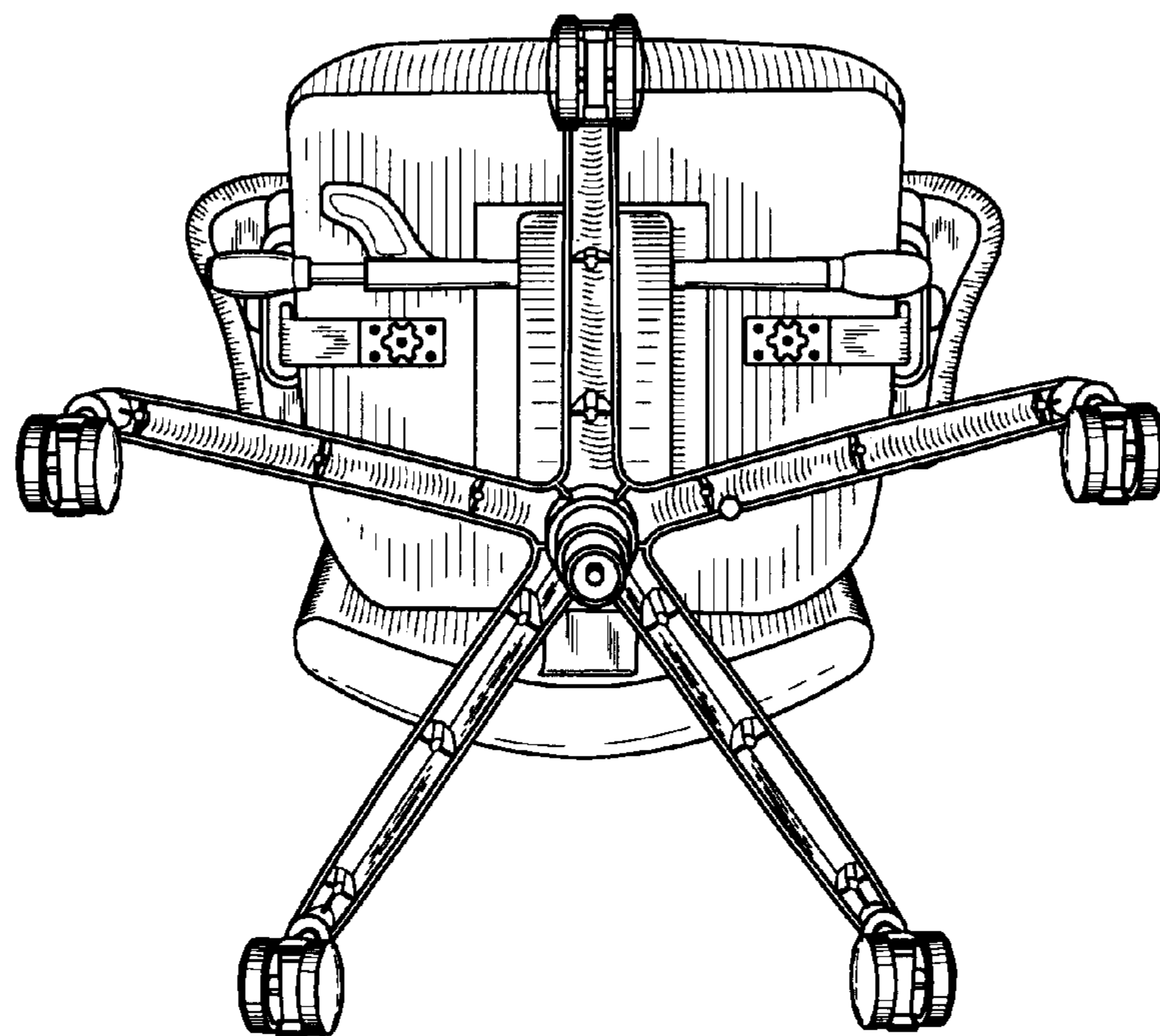

FIG. 7