



US00D541049S

(12) **United States Design Patent**
Huang

(10) **Patent No.:** **US D541,049 S**

(45) **Date of Patent:** **** Apr. 24, 2007**

(54) **CLEANING IMPLEMENT FOR HUMAN BODY**

(76) Inventor: **Chu-Chau Huang**, P.O. Box 26-757,
Taipei 106 (TW)

(**) Term: **14 Years**

(21) Appl. No.: **29/241,553**

(22) Filed: **Oct. 31, 2005**

(51) **LOC (8) Cl.** **04-01**

(52) **U.S. Cl.** **D4/120; D28/63**

(58) **Field of Classification Search** 15/106,
15/107, 110; 206/77.1, 204, 209; D1/130;
D24/101, 102, 103, 104; D4/116, 119, 120,
D4/127, 137; D28/7, 63; D3/200, 203.2,
D3/203.3

See application file for complete search history.

(56) **References Cited**

U.S. PATENT DOCUMENTS

1,587,024	A	*	6/1926	Murphy	15/107
D157,707	S	*	3/1950	Shelsey	D4/120
D166,124	S	*	3/1952	Pearce	D4/120
D189,266	S	*	11/1960	Harris	D4/116
3,197,851	A	*	8/1965	Aleck	228/157
D284,411	S	*	6/1986	Taylor, Jr.	D24/104

5,310,141	A	*	5/1994	Homer et al.	244/158.1
D349,238	S	*	8/1994	Haber	D3/203.2
D425,706	S	*	5/2000	Calderone	D4/116
D439,052	S	*	3/2001	Hay	D4/114
D440,768	S	*	4/2001	Chen	D4/120
D449,450	S	*	10/2001	Chen	D4/120
D458,031	S	*	6/2002	Park	D4/121

* cited by examiner

Primary Examiner—Alan P. Douglas

Assistant Examiner—Deanna Fluegeman

(74) *Attorney, Agent, or Firm*—Rosenberg, Klein & Lee

(57) **CLAIM**

The ornamental design for a “cleaning implement for human body,” as shown and described.

DESCRIPTION

FIG. 1 is a perspective view of a “cleaning implement for human body” showing my new design;

FIG. 2 is a front view thereof;

FIG. 3 is a rear view thereof;

FIG. 4 is a left side view thereof;

FIG. 5 is a right side view thereof;

FIG. 6 is a top view thereof;

FIG. 7 is a bottom view thereof; and,

FIG. 8 is an exploded view thereof.

1 Claim, 5 Drawing Sheets

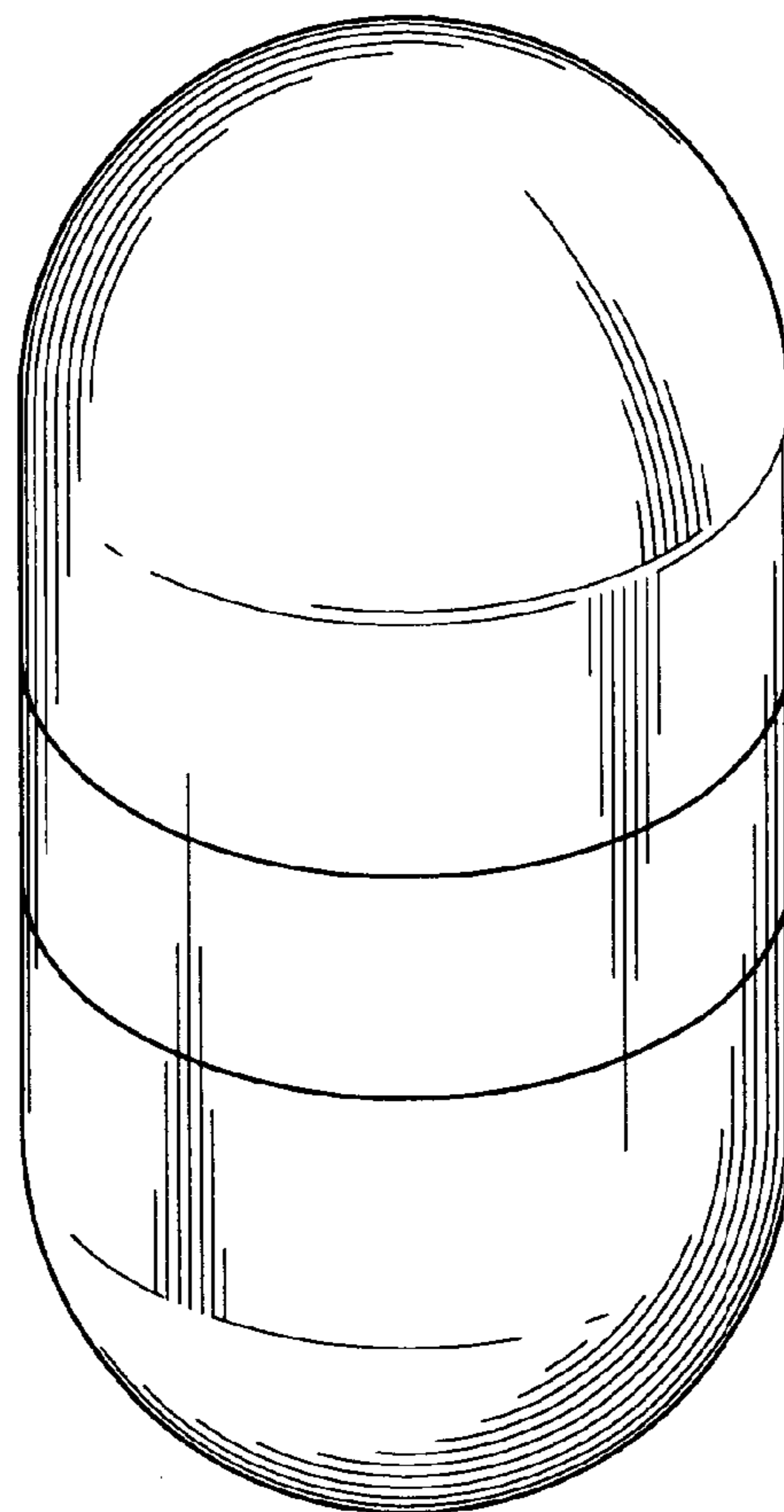

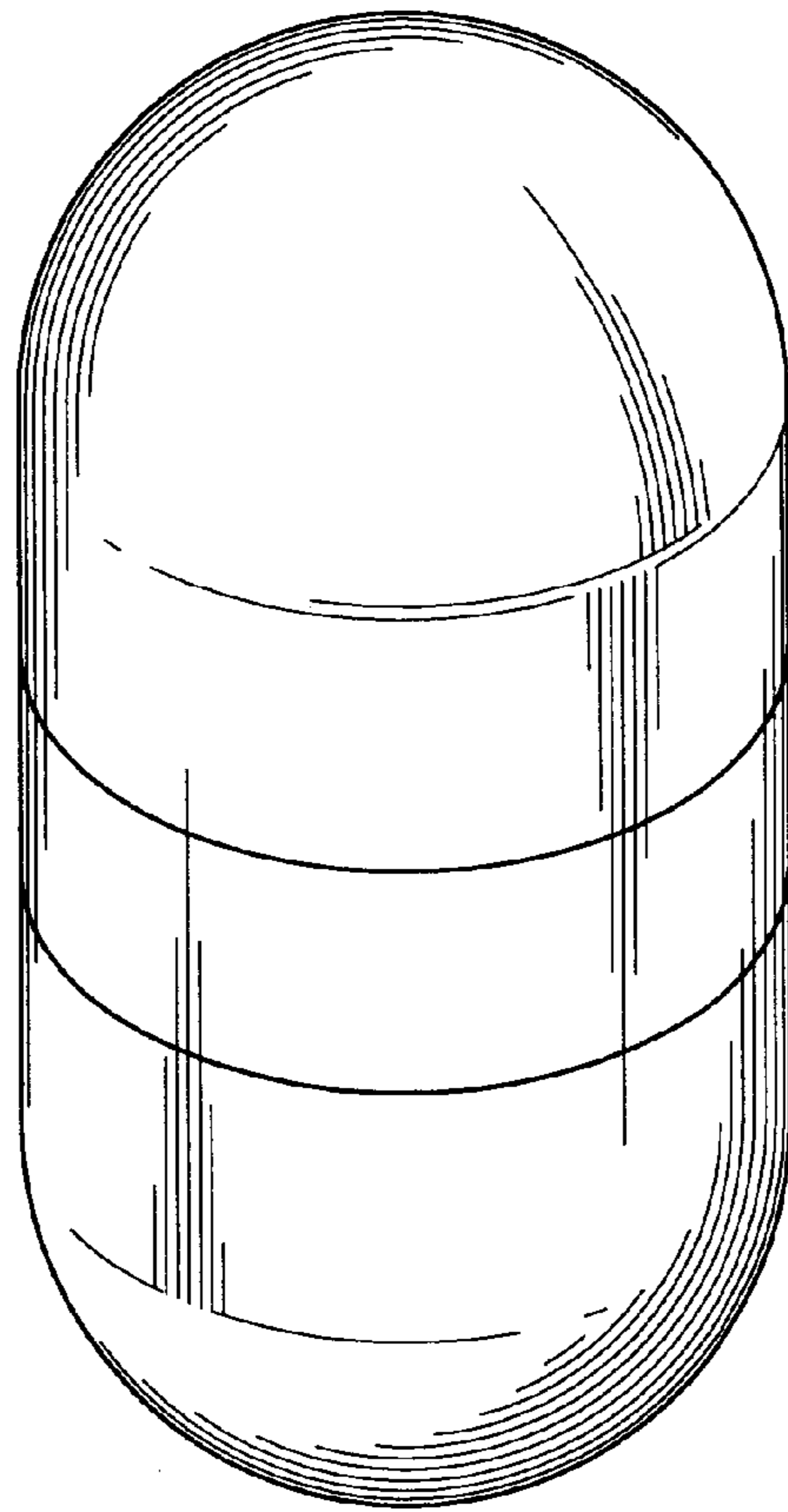

FIG. 1

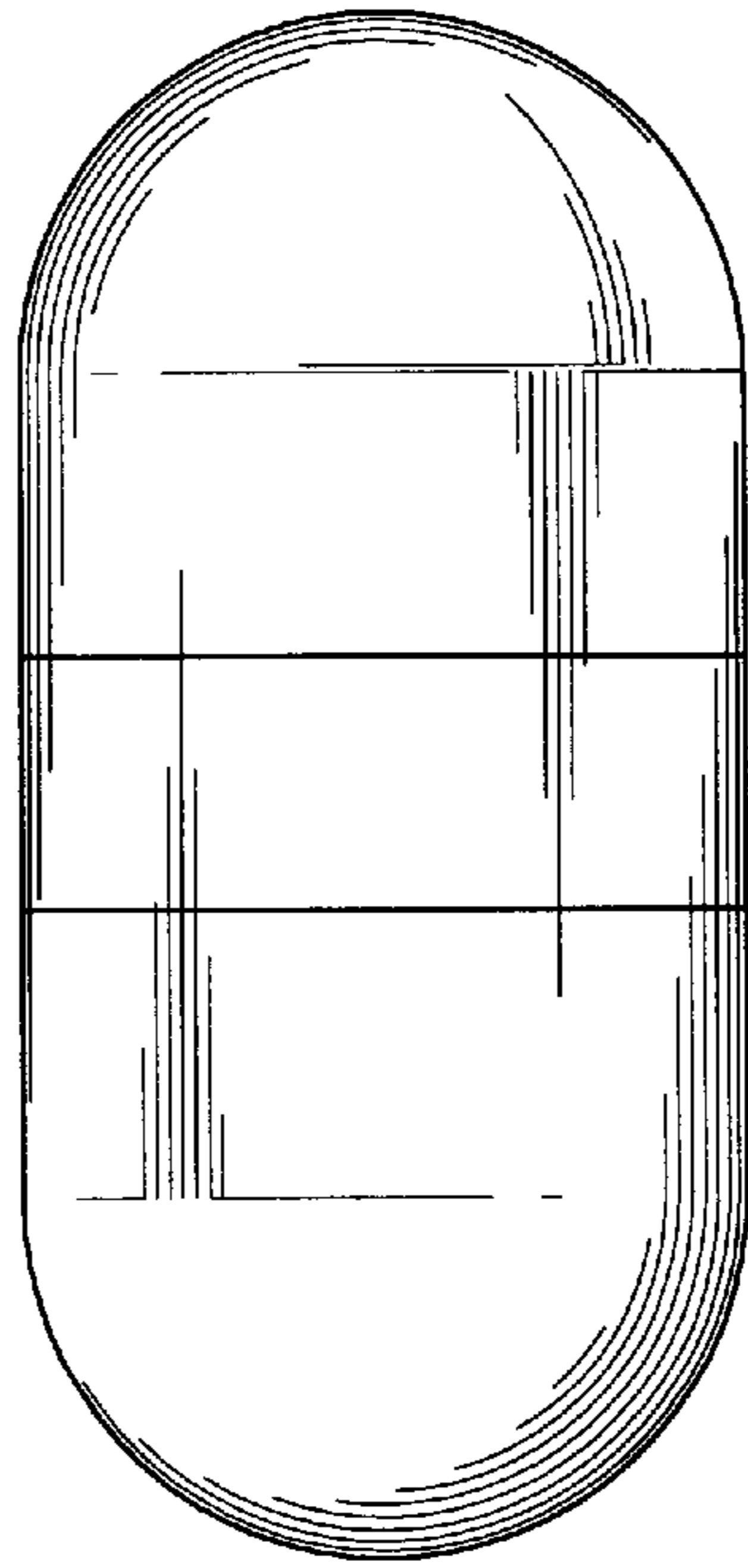

FIG. 2

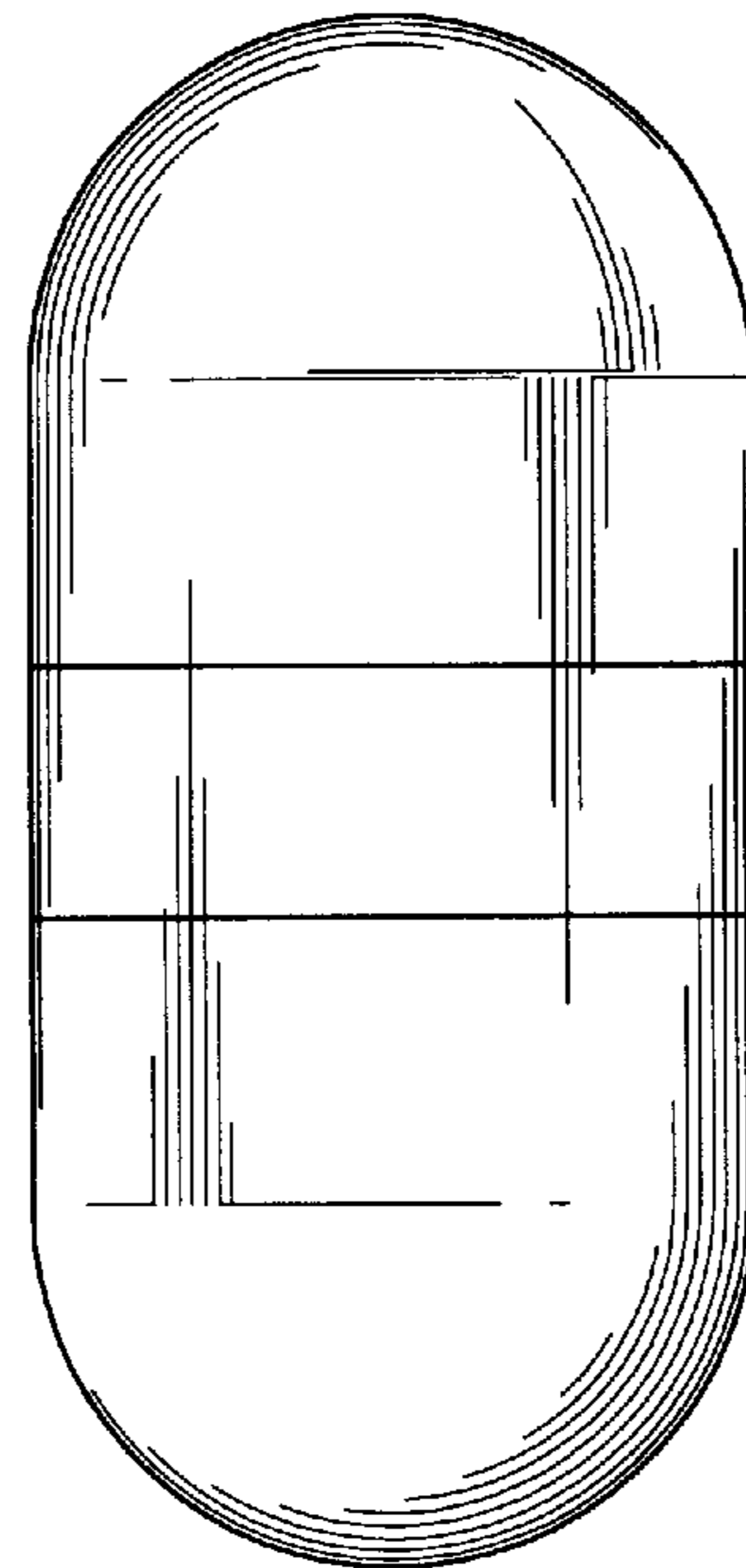

FIG. 3

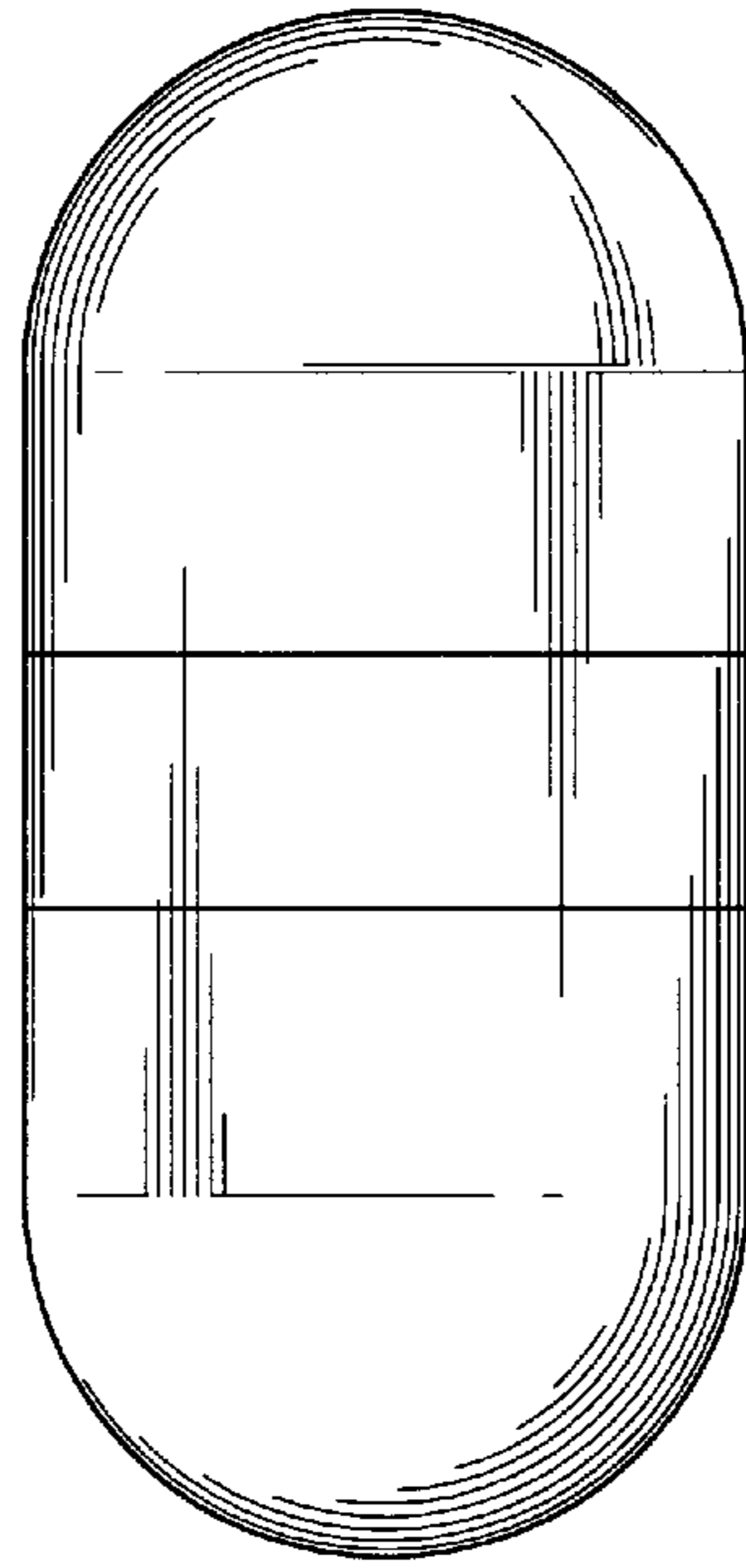

FIG. 4

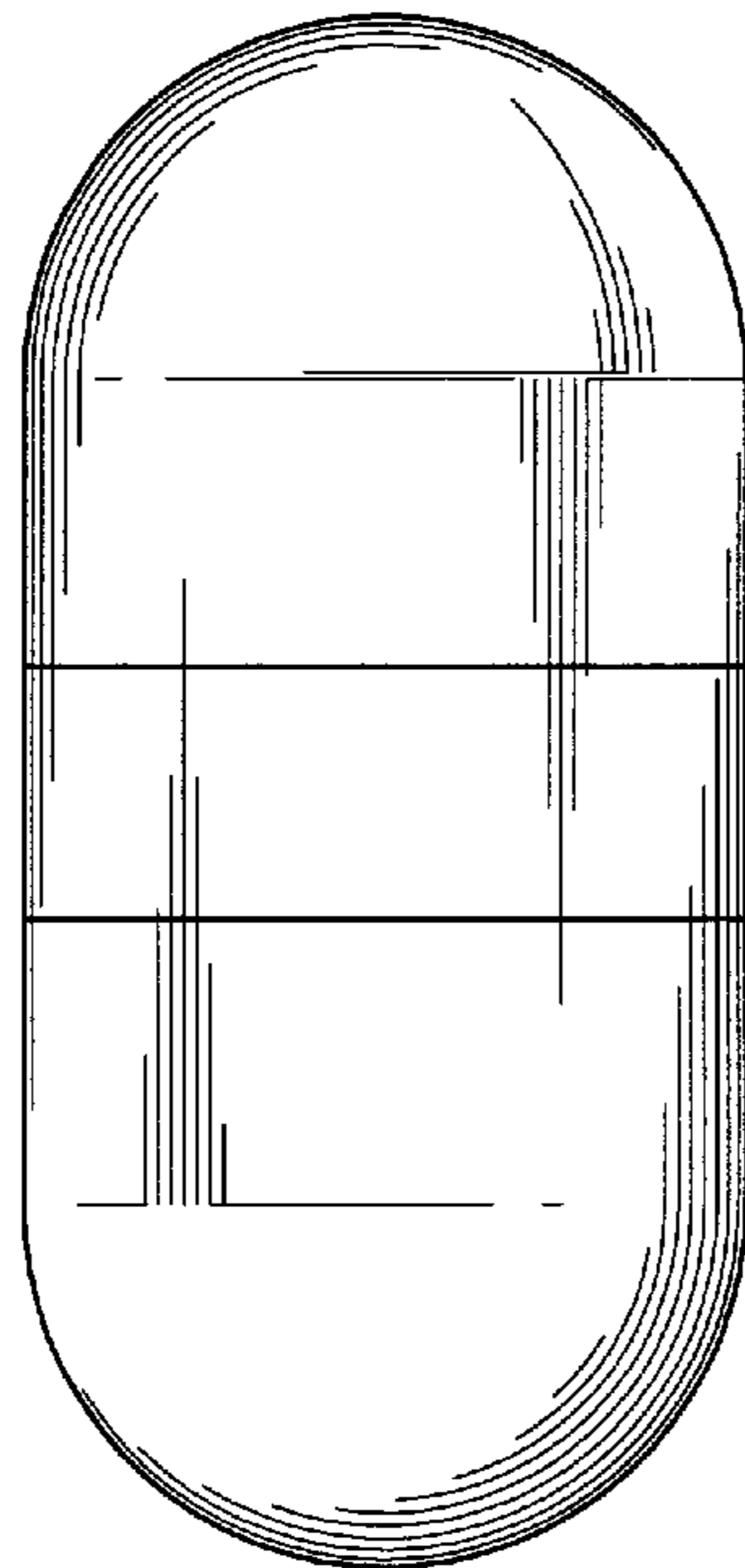

FIG. 5

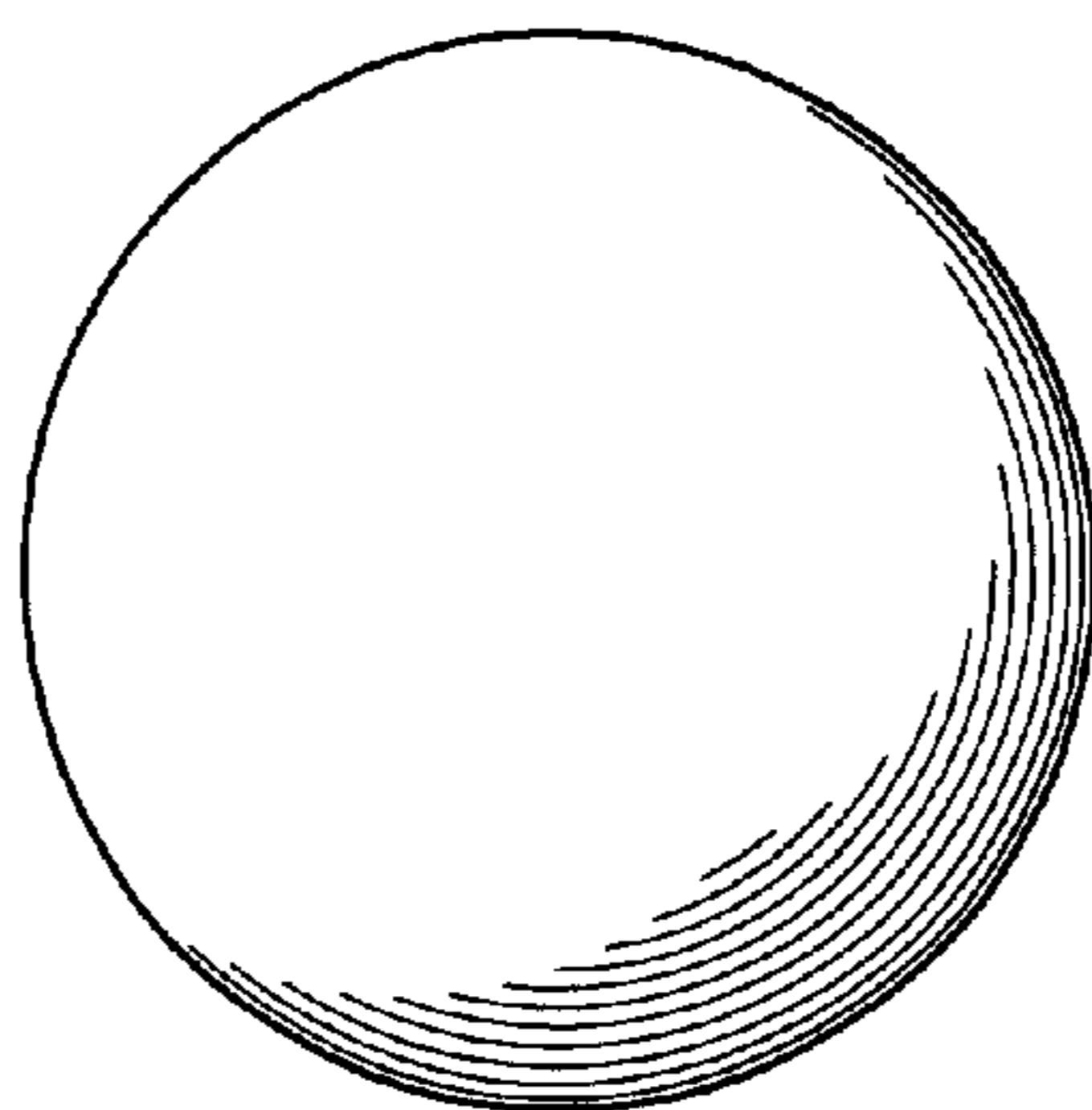

FIG. 6

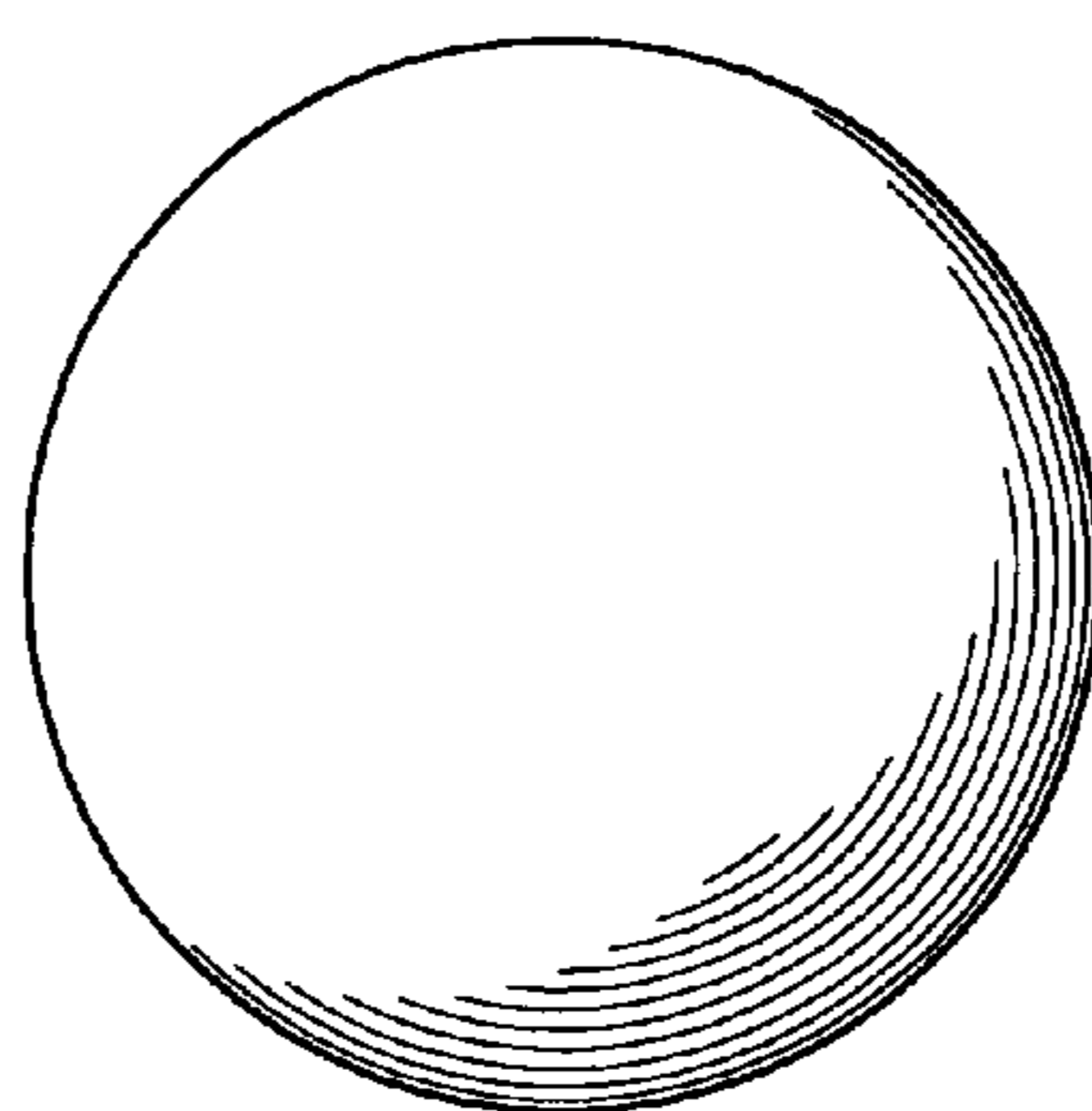

FIG. 7

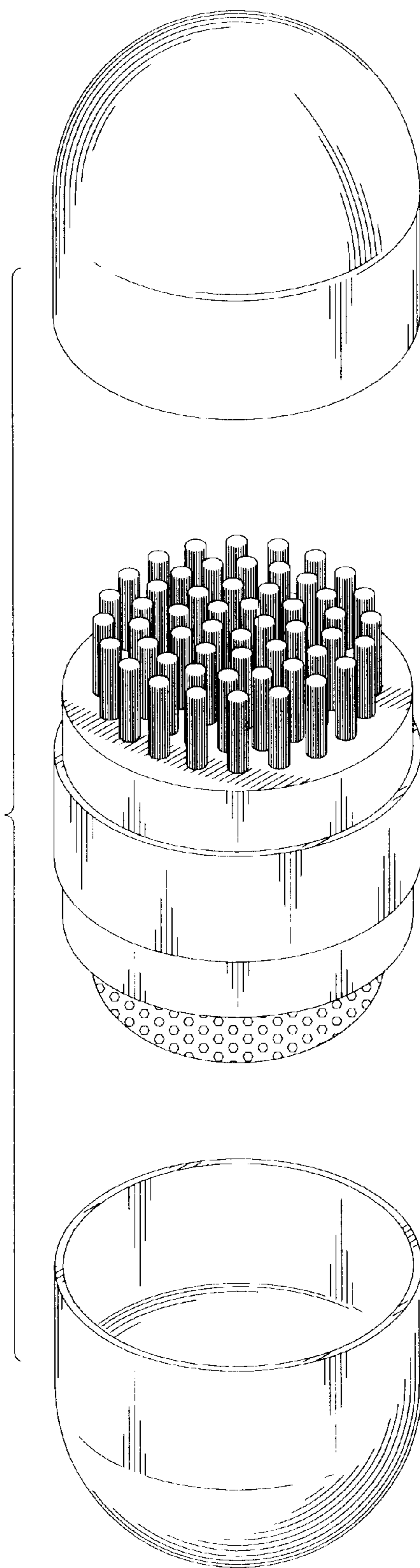

FIG 8