



US00D541038S

(12) **United States Design Patent**  
**Barthelmess**

(10) **Patent No.:** **US D541,038 S**

(45) **Date of Patent:** **\*\* Apr. 24, 2007**

(54) **TROPICAL TREE ASSEMBLY FOR A PATIO TABLE**

(75) Inventor: **Peter Barthelmess**, Cerritos, CA (US)

(73) Assignee: **Barcana, Inc.**, Cerritos, CA (US)

(\*\*) Term: **14 Years**

(21) Appl. No.: **29/259,404**

(22) Filed: **May 8, 2006**

(51) **LOC (8) Cl.** ..... **11-04**

(52) **U.S. Cl.** ..... **D3/6; D11/118; D6/416; D6/480; D6/487**

(58) **Field of Classification Search** ..... **D11/118, D11/130.1; D3/5, 6; D6/416, 480, 487; 47/40.5; 248/511, 519; 362/123, 567; 135/15.1, 33.7; 160/53; 62/281**

See application file for complete search history.

(56) **References Cited**

**U.S. PATENT DOCUMENTS**

1,936,428 A \* 11/1933 Friesner ..... 108/28

(Continued)

*Primary Examiner*—Dominic Simone

(74) *Attorney, Agent, or Firm*—Richard B. Klar; Law Office of Richard B. Klar

(57) **CLAIM**

The ornamental design for a tropical tree assembly for a patio table, as shown and described.

**DESCRIPTION**

FIG. 1 is a perspective view of a tropical tree assembly for a patio table, showing my new design, the table shown in broken lines for illustrative purposes only and forms no part of the claimed design;

FIG. 2 is a perspective view of the top part of the tree assembly of FIG. 1 in a closed position, shown separately for ease of illustration;

FIG. 3 is a perspective view of a second embodiment of FIG. 2, the trunk shown with a decorative cover;

FIG. 4 is a front elevational view of the support structure of FIG. 1, shown separately for ease of illustration, the rear being identical;

FIG. 5 is a top plan view of FIG. 4;

FIG. 6 is a side elevational view of FIG. 4, the opposite side substantially the same;

FIG. 7 is a bottom plan view of FIG. 4;

FIG. 8 is a front elevational view of a second embodiment of FIG. 4, the support structure having a sleeve cover, the rear being identical;

FIG. 9 is a top plan view of FIG. 8;

FIG. 10 is a side elevational view of FIG. 8, the opposite side being substantially the same;

FIG. 11 is a front elevational view of a third embodiment of FIG. 4, the support structure having a sleeve cover, the rear being identical;

FIG. 12 is a perspective view of a second embodiment of a FIG. 1, the table shown in broken lines for illustrative purposes only and forms no part of the claimed design;

FIG. 13 is a perspective view of the top part of the trunk of the tree assembly of FIG. 12, the branches removed for ease of illustration;

FIG. 14 is a top plan view of a branch of the tree assembly of FIG. 12, shown separately for ease of illustration;

FIG. 15 is a front elevational view of the support structure of FIG. 12, shown separately for ease of illustration, the rear being identical;

FIG. 16 is a side elevational view of FIG. 15, the opposite side being substantially similar;

FIG. 17 is a perspective view of a third embodiment of FIG. 1, the patio table shown in broken lines for illustrative purposes only and forms no part of the claimed design;

FIG. 18 is a perspective view of the top part of FIG. 17, the branches removed for ease of illustration;

FIG. 19 is a top plan view of a branch of FIG. 17 shown separately for ease of illustration;

FIG. 20 is a front elevational view of the support structure of FIG. 17, the trunk having a decorative sleeve cover, the rear being identical; and,

FIG. 21 is a side elevational view of FIG. 20, the opposite side being substantially similar.

The elements shown in broken lines are not parts of the design.

**1 Claim, 8 Drawing Sheets**

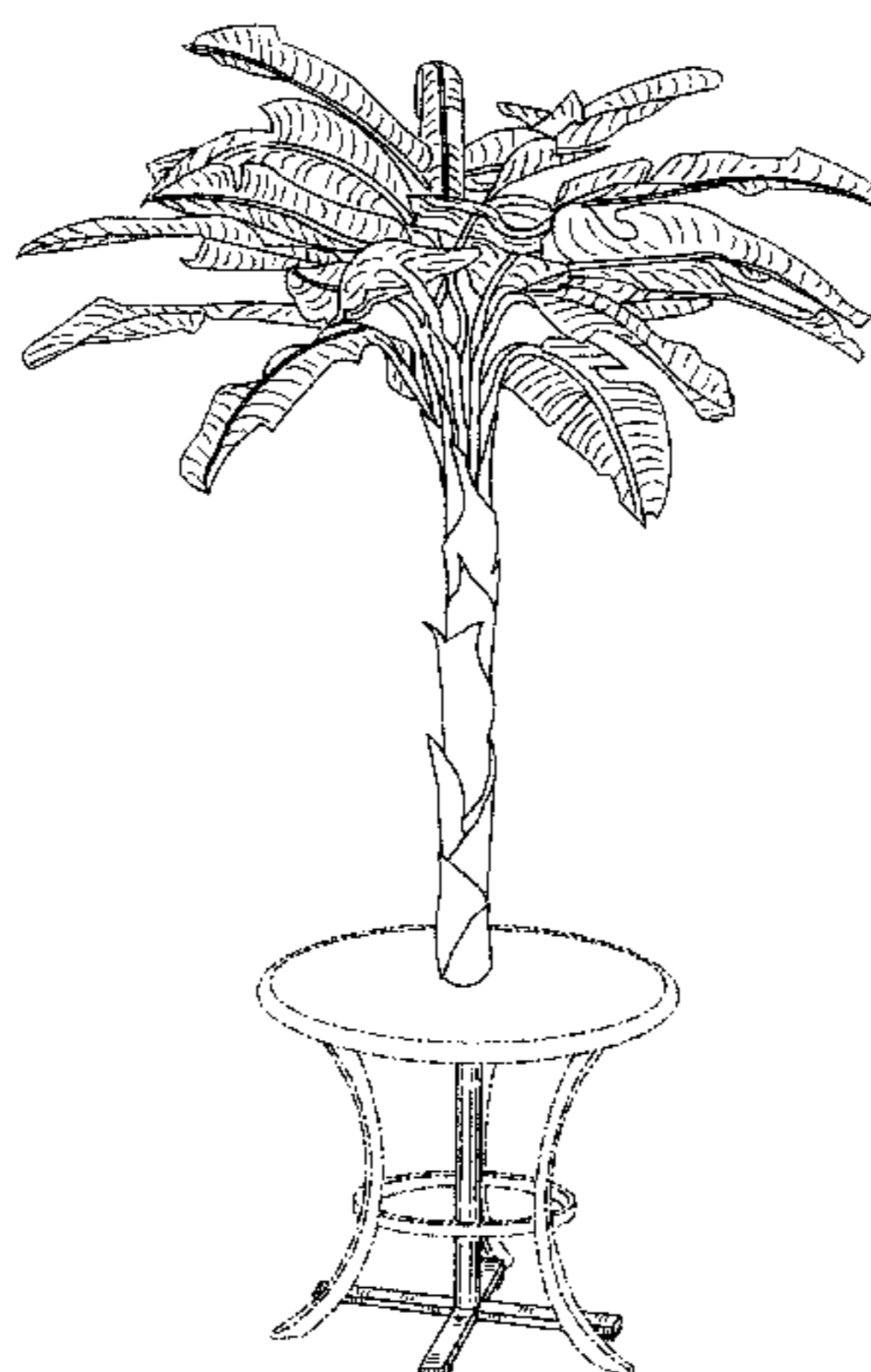

# US D541,038 S

Page 2

## U.S. PATENT DOCUMENTS

1,943,659	A	1/1934	Eason	
2,080,523	A *	5/1937	Williams et al.	428/18
2,188,529	A *	1/1940	Corina	362/123
2,251,705	A *	8/1941	Gonzalez	62/281
2,455,288	A *	11/1948	Alvarez	135/19.5
D159,609	S *	8/1950	Goldberg	D6/487
2,760,052	A	8/1956	Owen	
2,841,901	A *	7/1958	Maple	428/9
2,851,807	A *	9/1958	Taylor	428/19
3,073,558	A *	1/1963	De Klotz	47/40.5
3,679,528	A *	7/1972	Spiegel	428/7
D225,498	S *	12/1972	Norton	D11/130.1
4,462,065	A	7/1984	Rhodes	
D278,891	S *	5/1985	Levin	D11/130.1
4,734,301	A *	3/1988	McKinney	428/8
4,920,897	A *	5/1990	Reed et al.	108/150
5,085,900	A *	2/1992	Hamlett	428/18
5,091,227	A *	2/1992	Wright et al.	428/18
D336,557	S	6/1993	Wade	
D343,318	S *	1/1994	Curitti	D6/503
D353,788	S *	12/1994	Frost et al.	D11/130.1
D370,556	S *	6/1996	Yu	D3/5
D383,900	S *	9/1997	Bart	D3/6
D390,157	S *	2/1998	Burnett	D11/118
5,713,554	A *	2/1998	Lai	248/522
D396,018	S *	7/1998	Stover et al.	D11/118
D401,886	S *	12/1998	Burnett	D11/131
5,869,151	A *	2/1999	Chong	428/18
6,030,670	A	2/2000	Chang	
6,234,443	B1 *	5/2001	Tsai et al.	248/519
6,250,322	B1 *	6/2001	Porter	135/98
6,323,431	B1	11/2001	Lin	
6,458,435	B1 *	10/2002	Lai	428/20
6,527,413	B1	3/2003	McIngvale	
6,571,814	B2 *	6/2003	You	135/33.7
6,599,591	B1 *	7/2003	Scott	428/18
6,869,198	B1 *	3/2005	Garza	362/123

\* cited by examiner

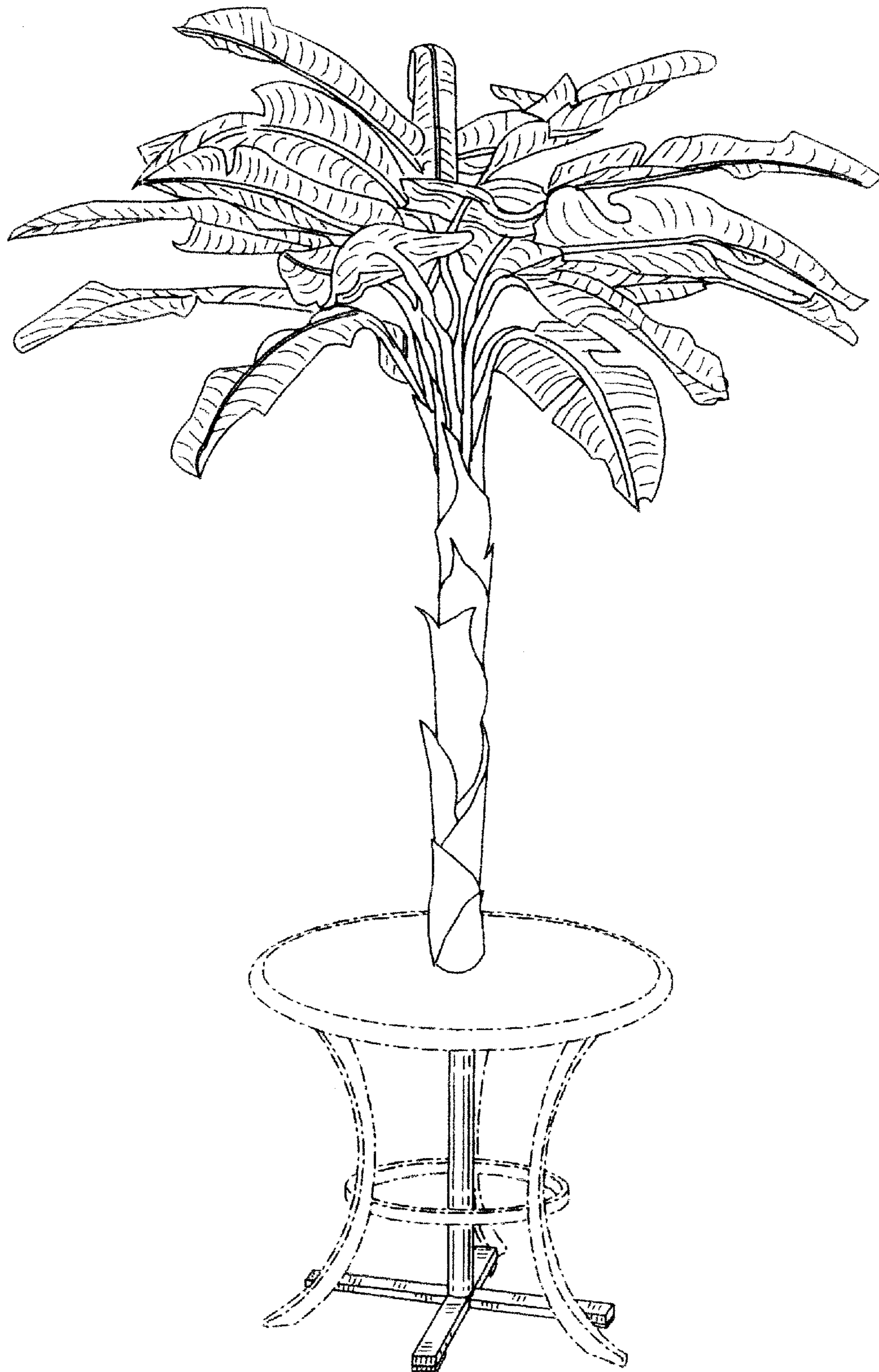

FIG. 1



FIG. 2



FIG. 3

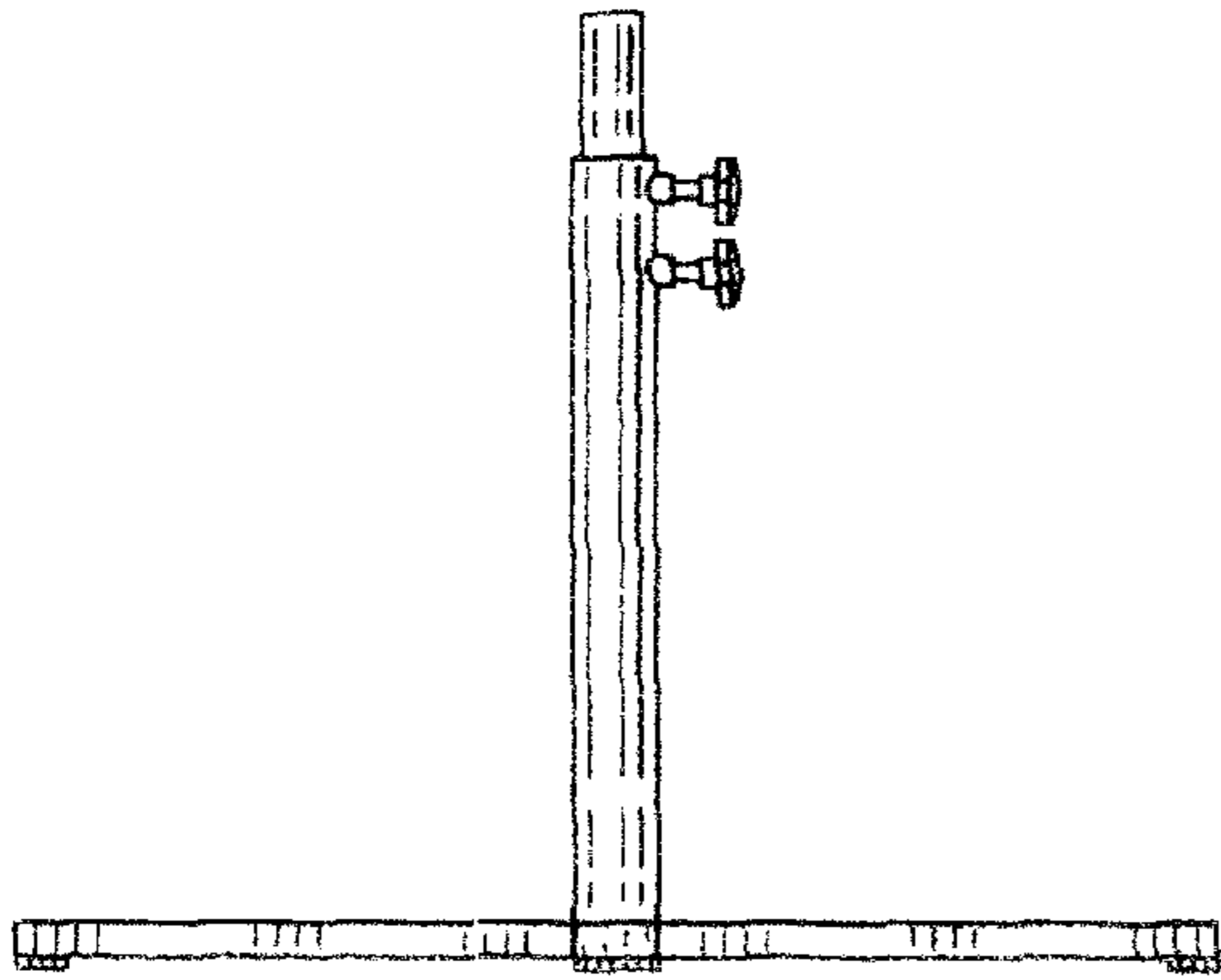

FIG. 4

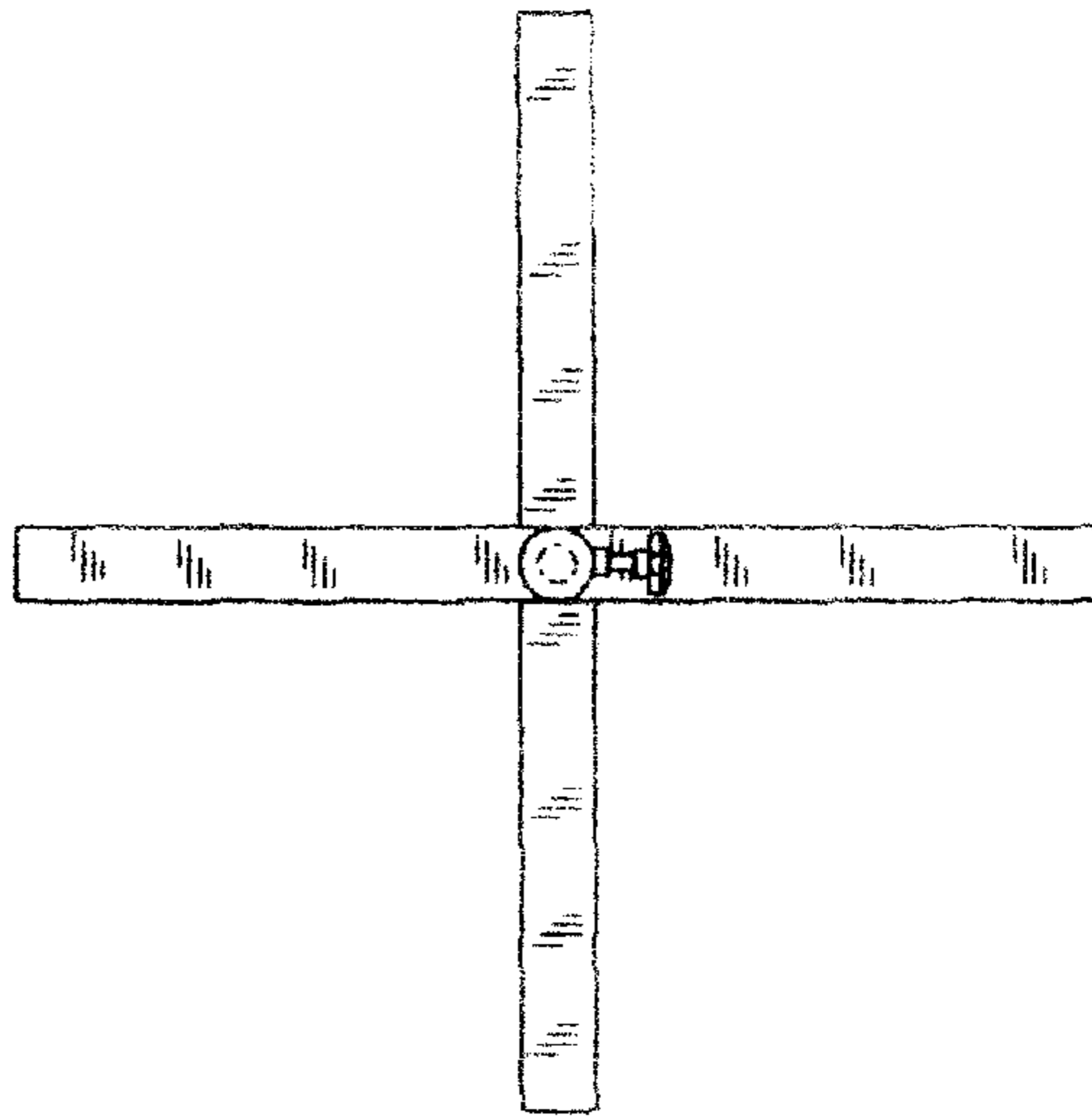

FIG. 5

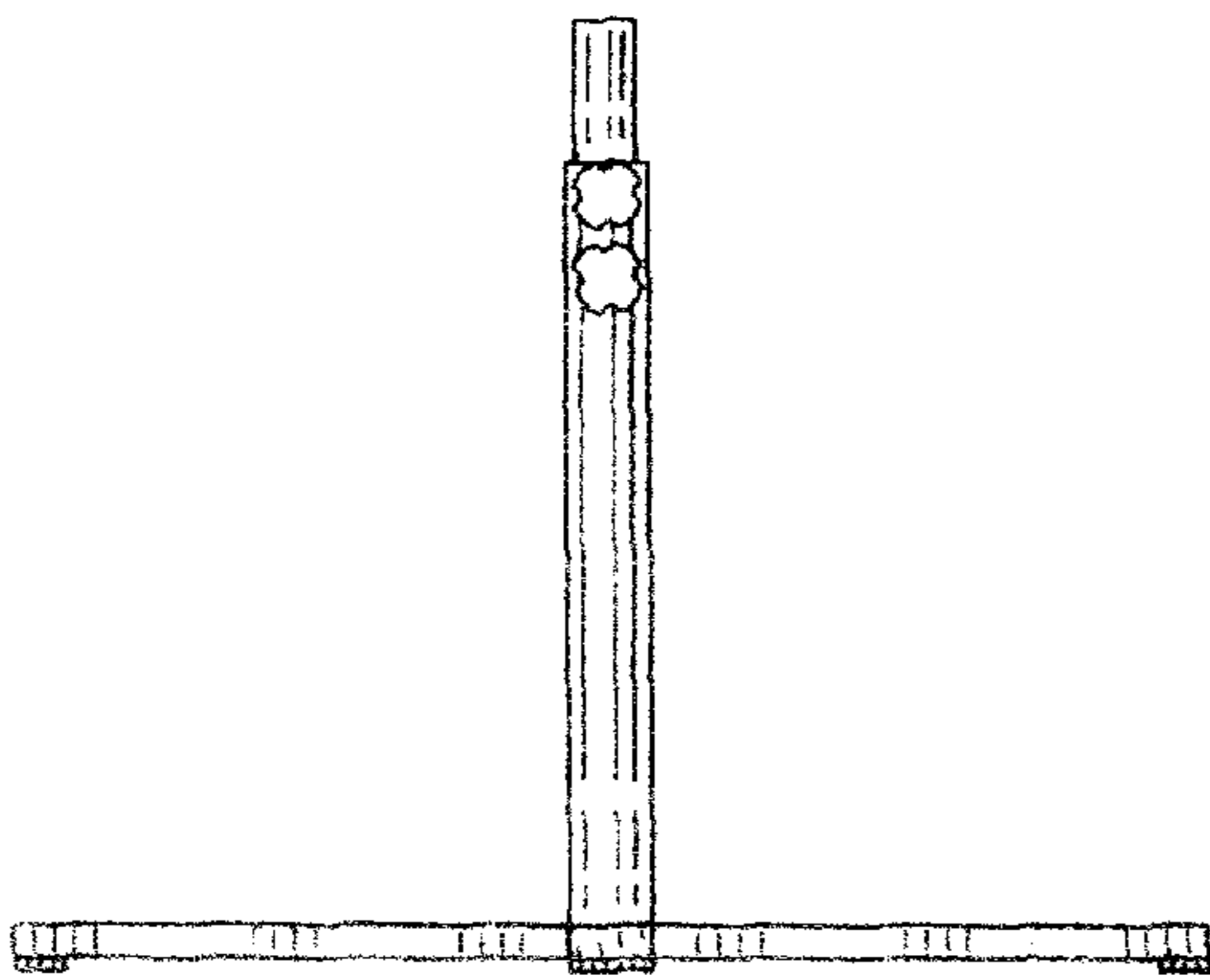

FIG. 6

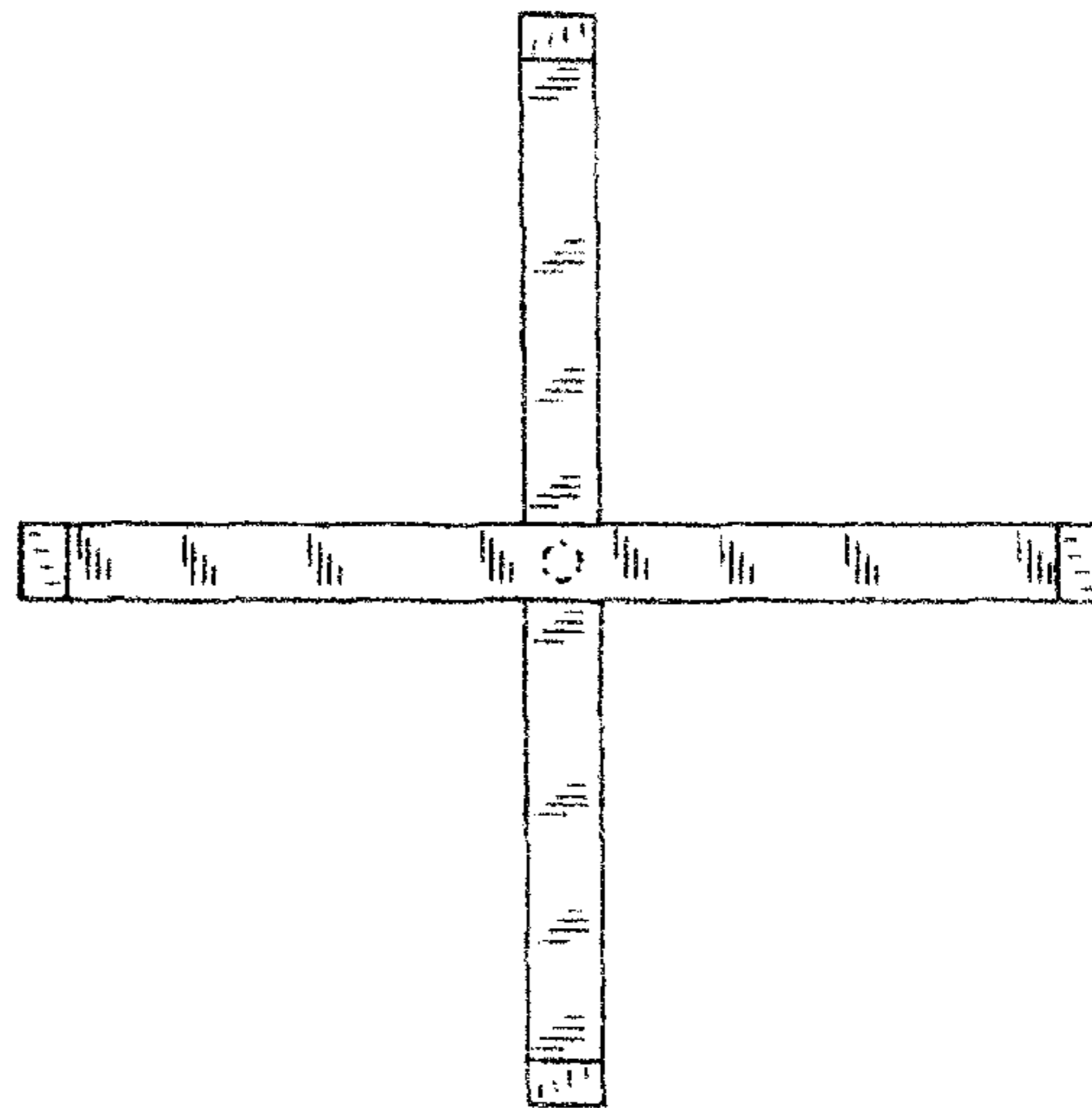

FIG. 7

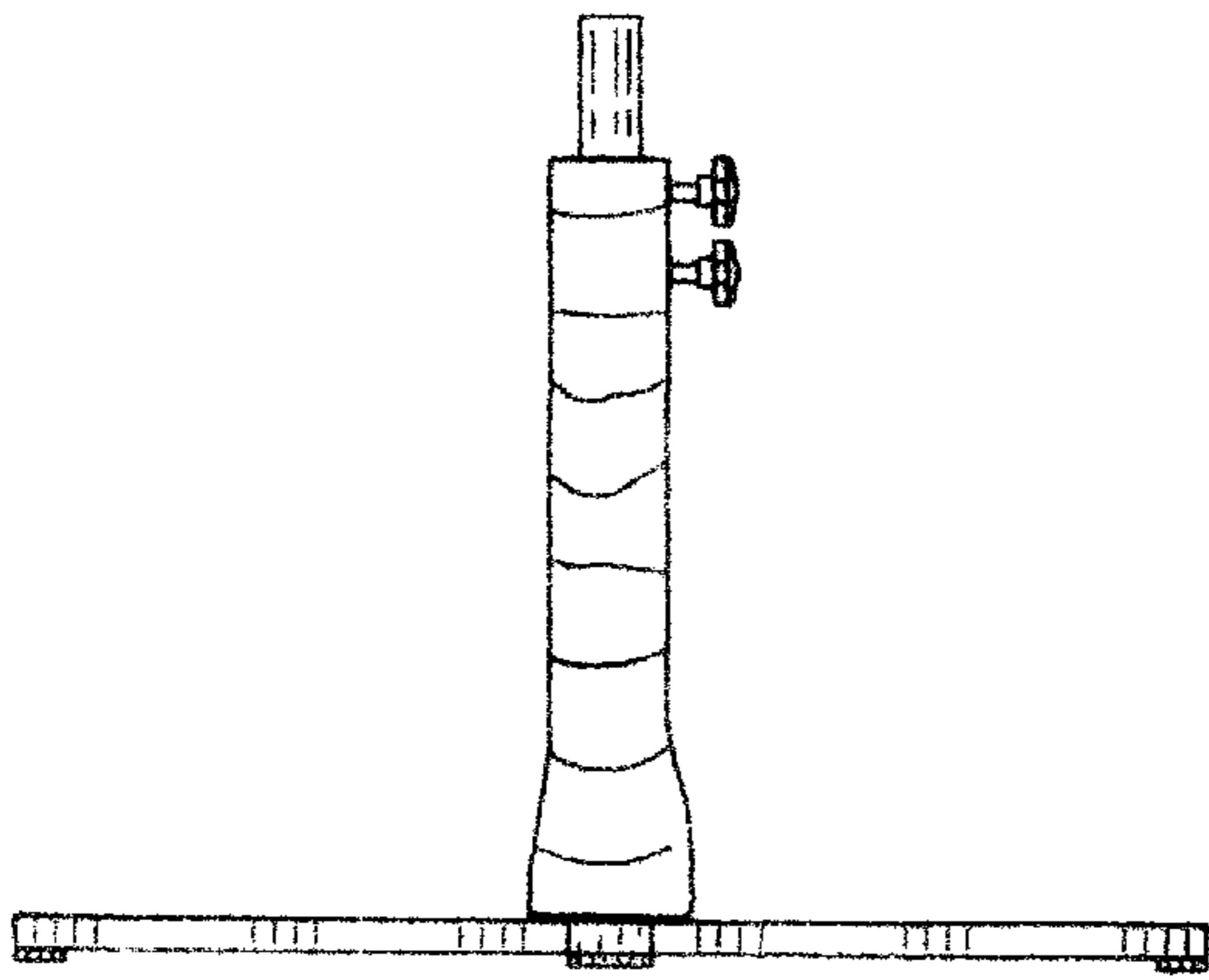

FIG. 8

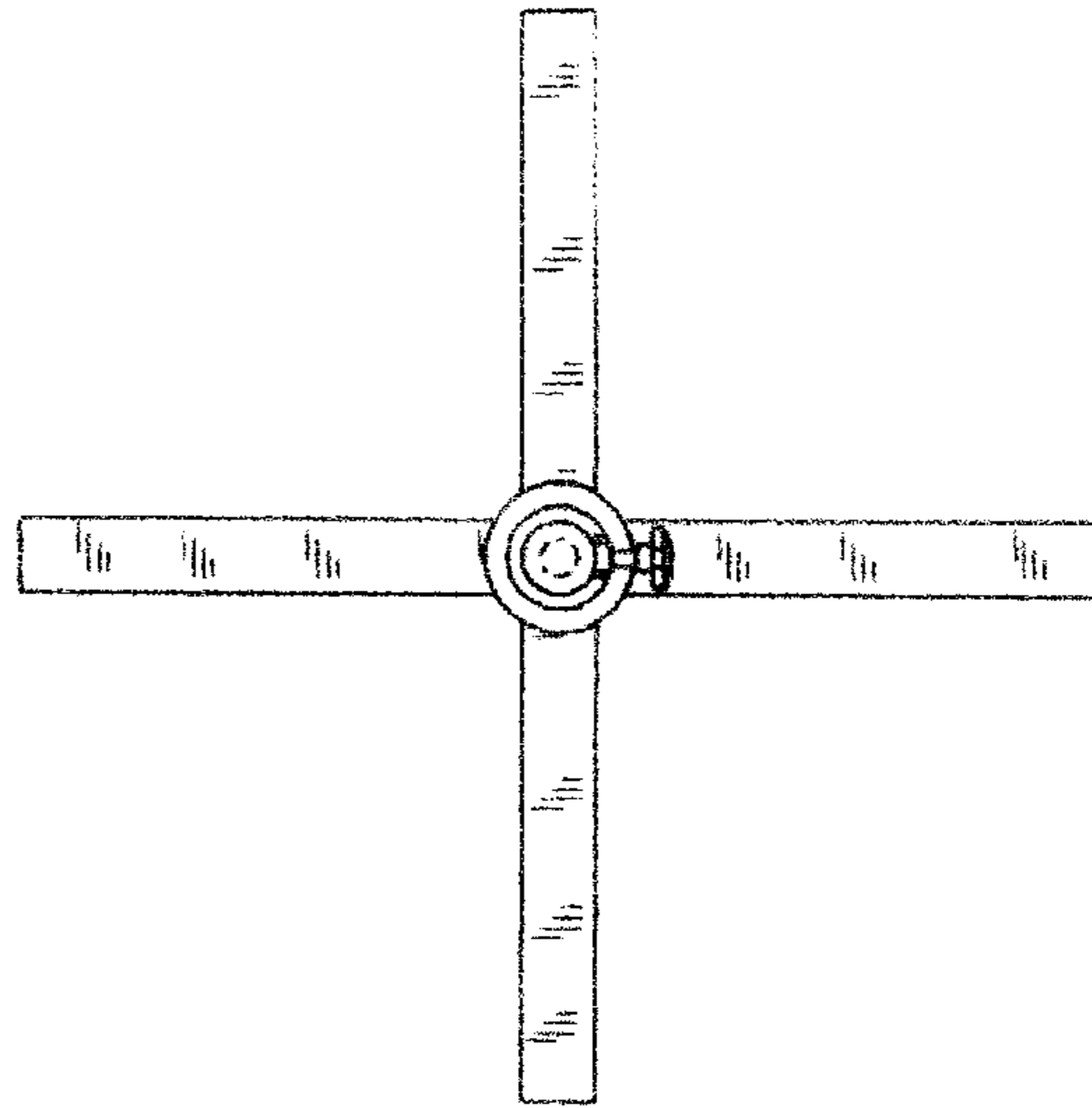

FIG. 9

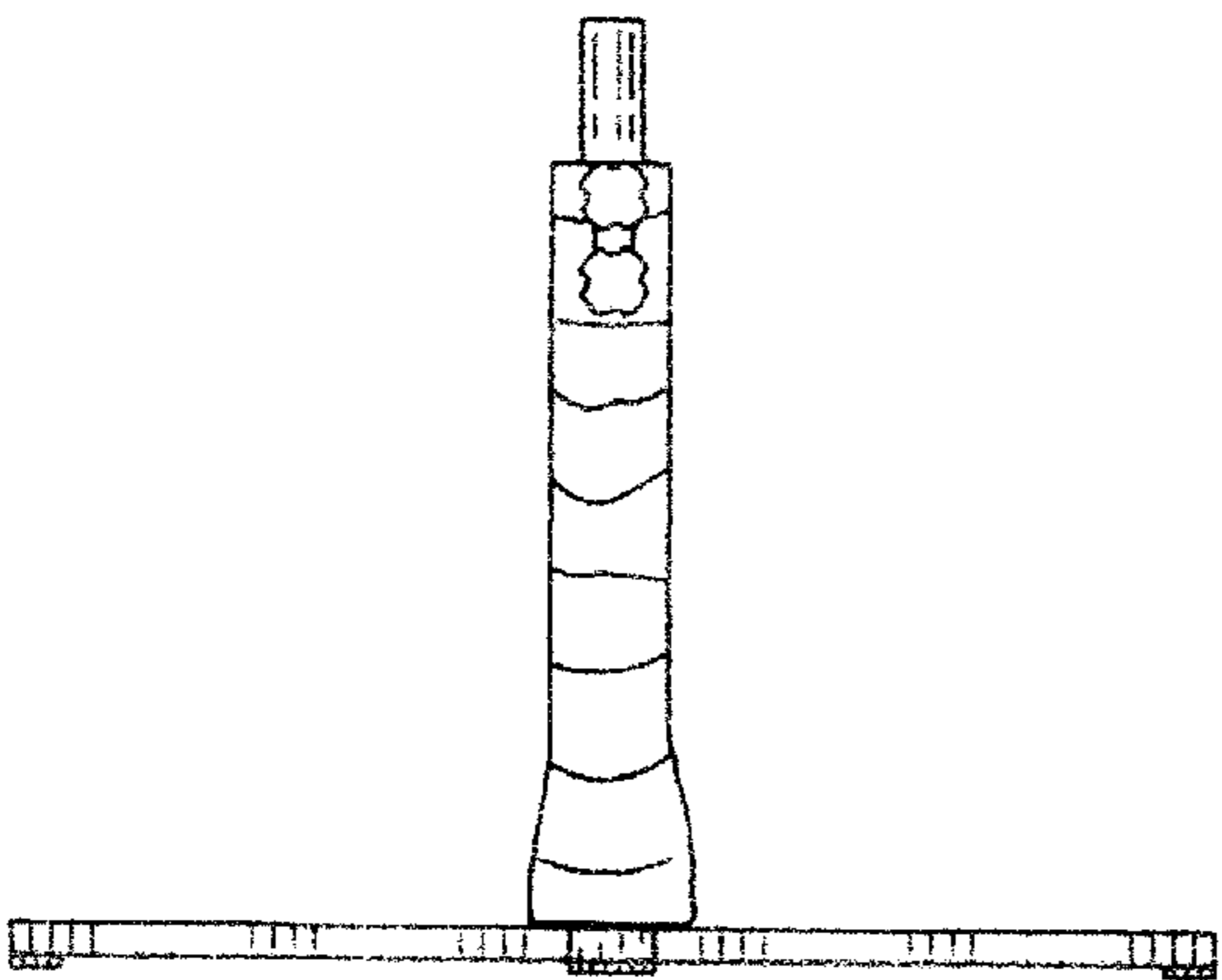

FIG. 10

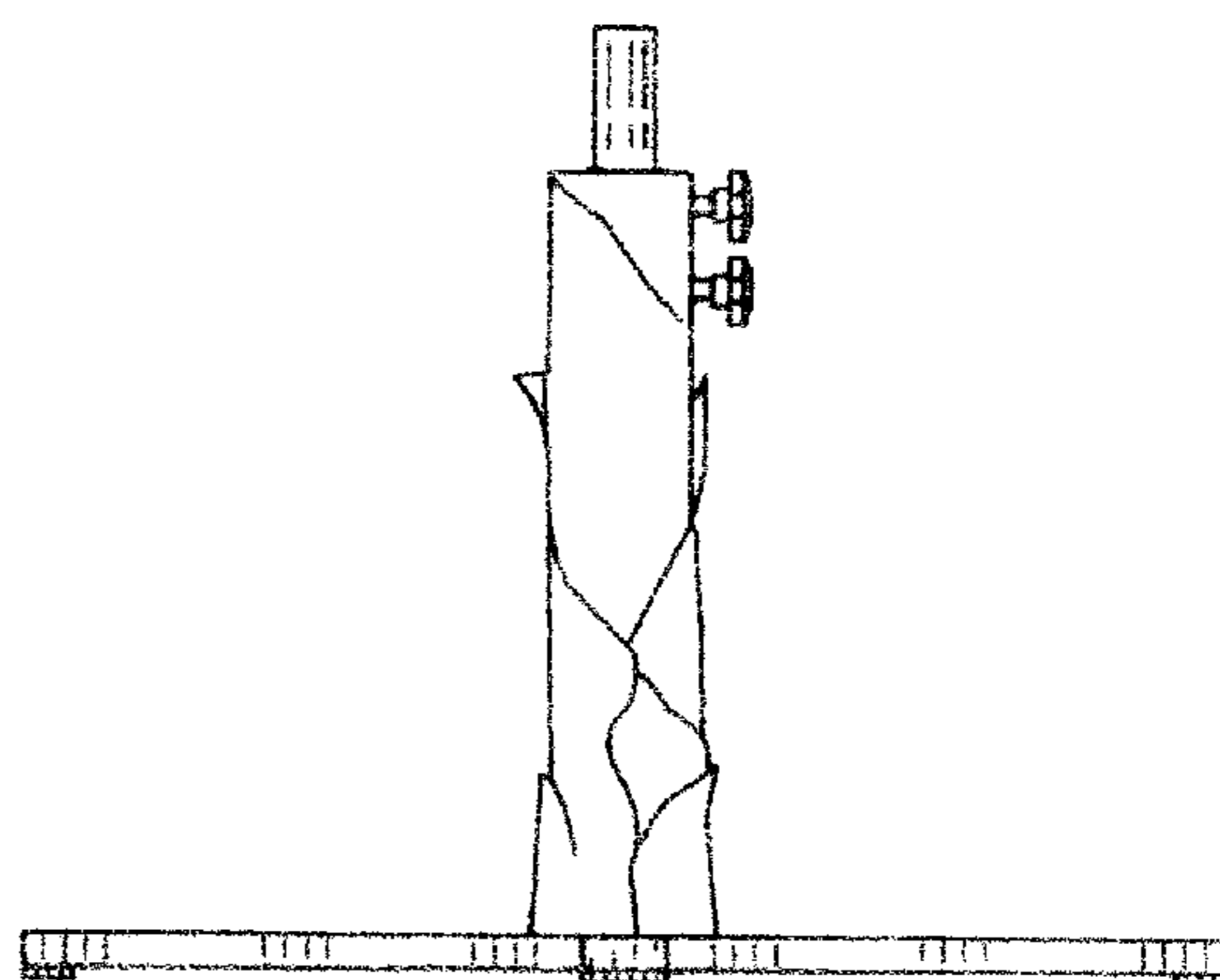

FIG. 11

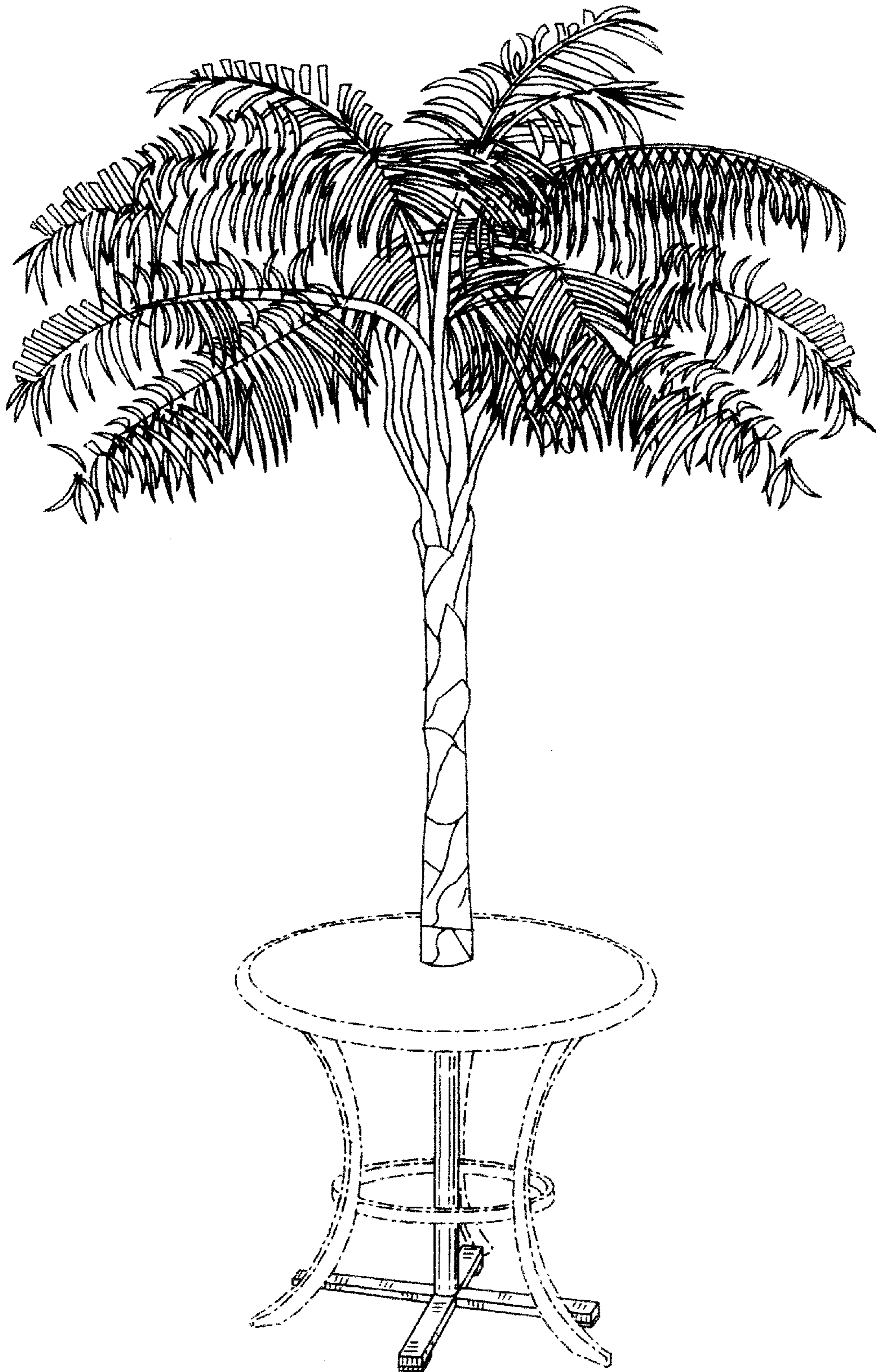

FIG. 12

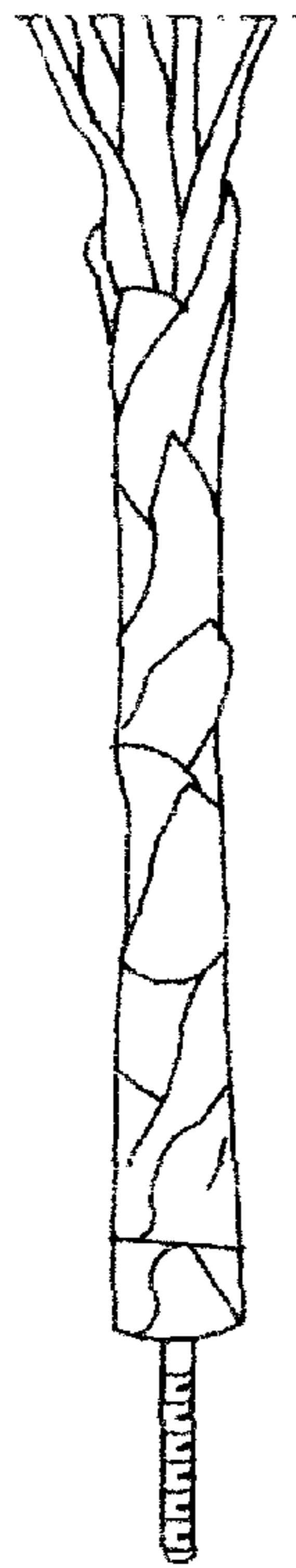

FIG. 13

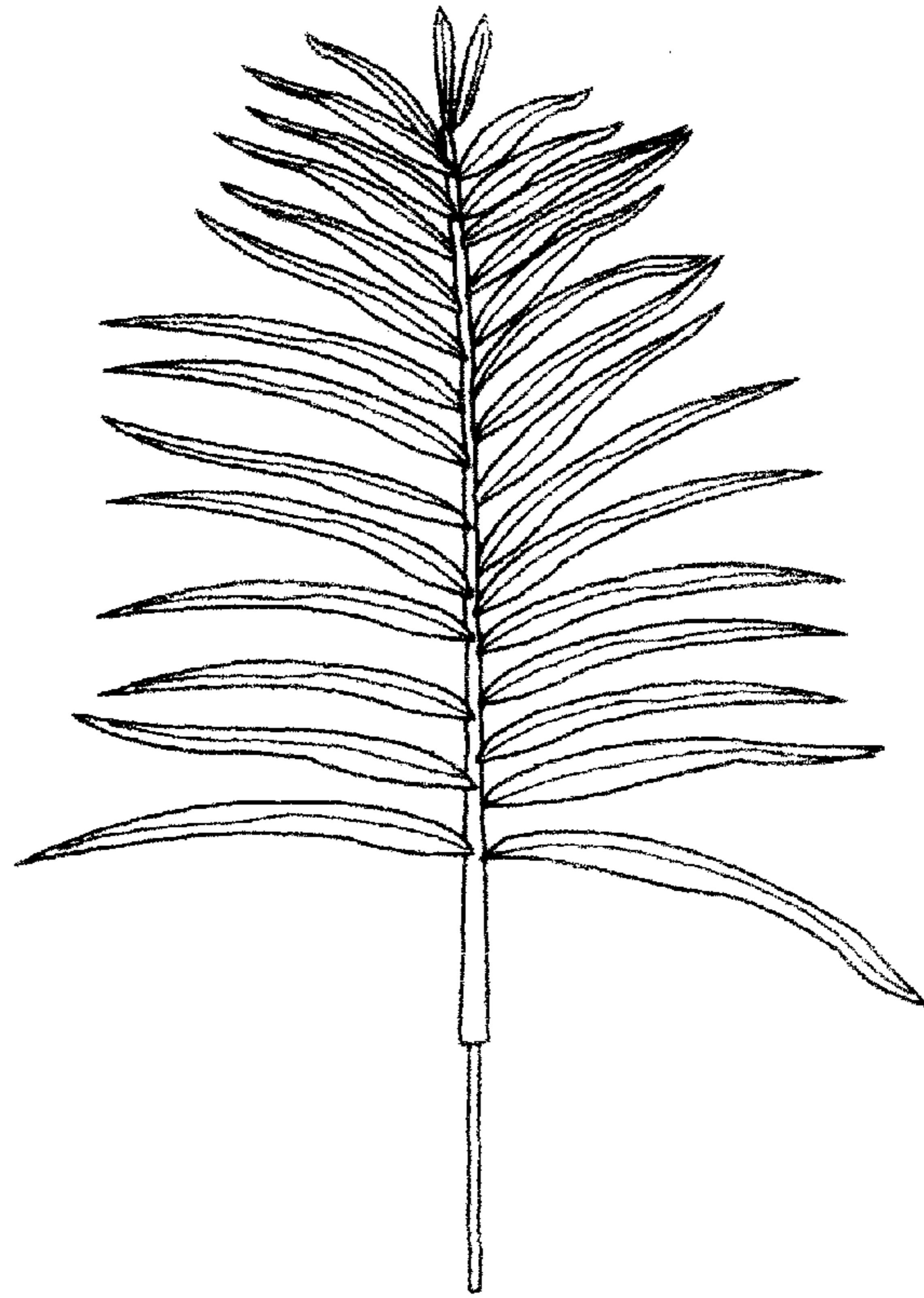

FIG. 14

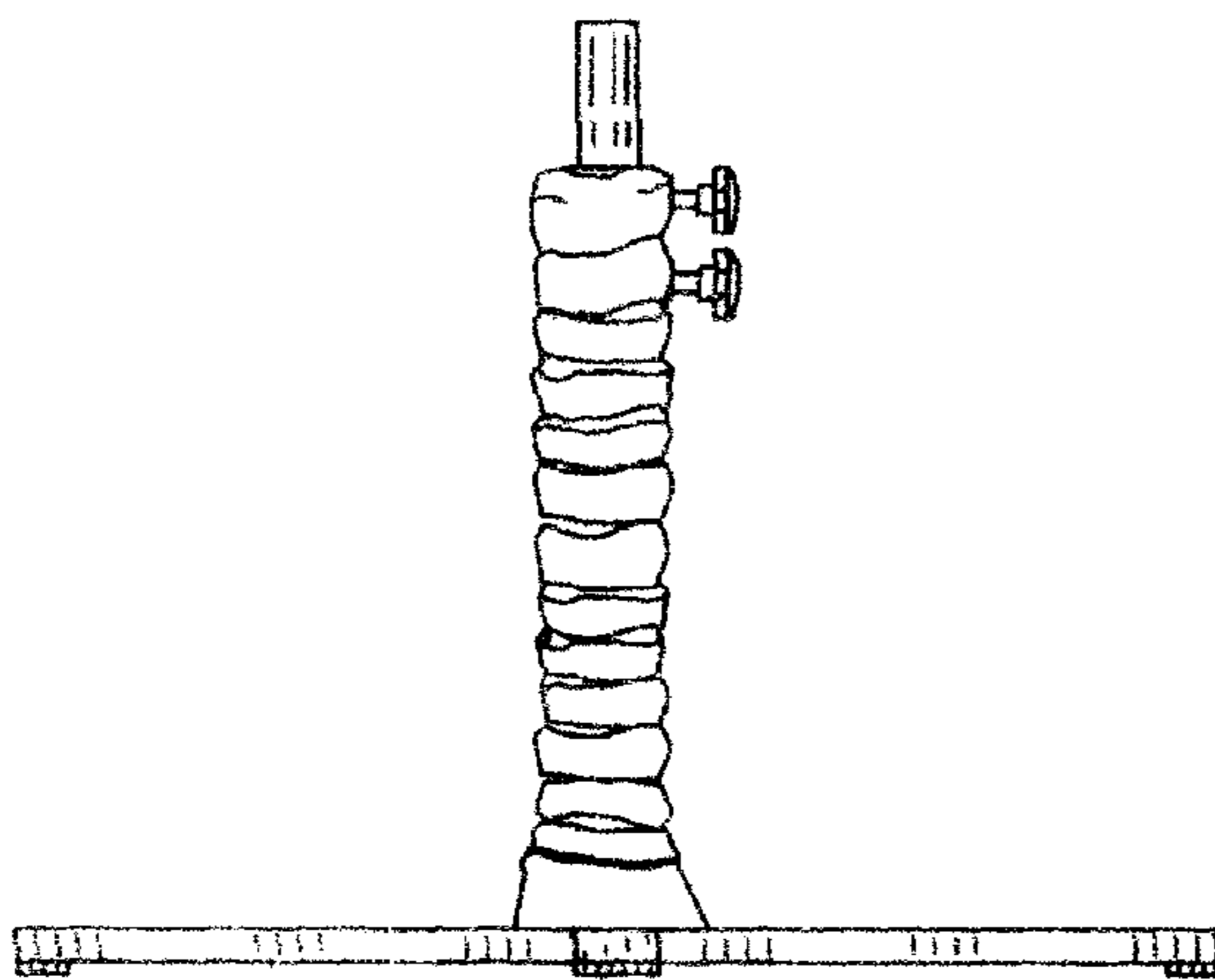

FIG. 15

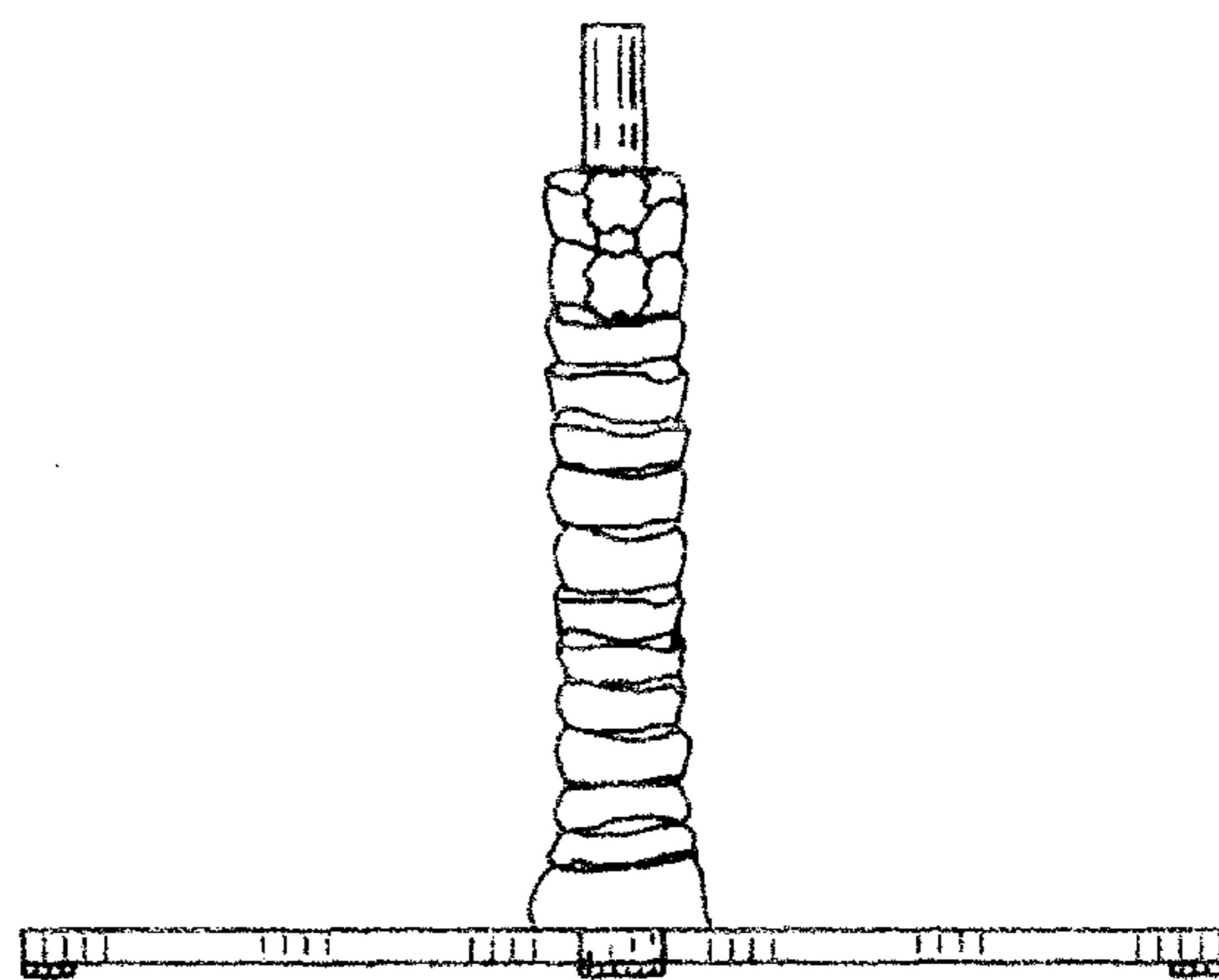

FIG. 16



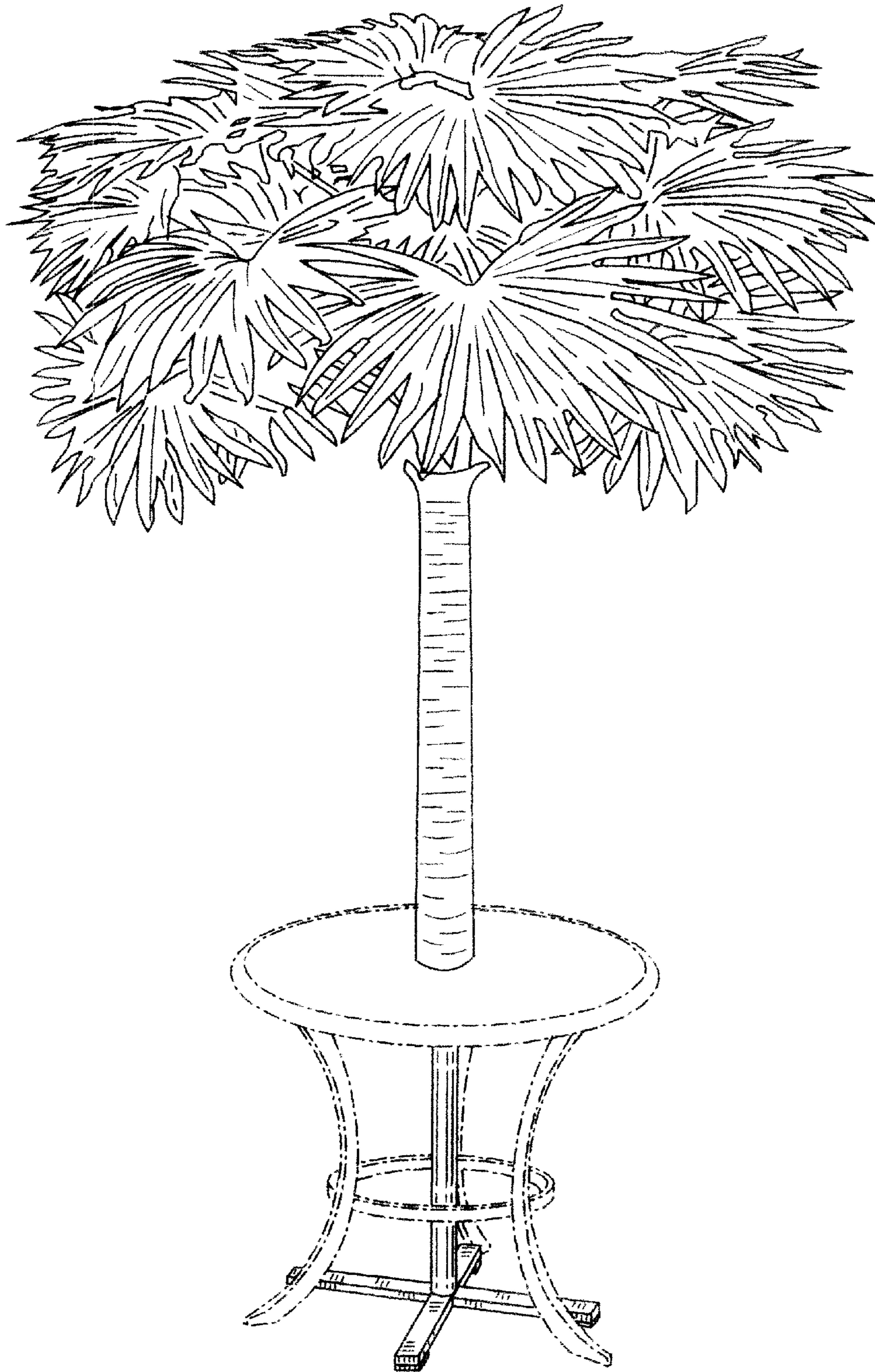

FIG. 17

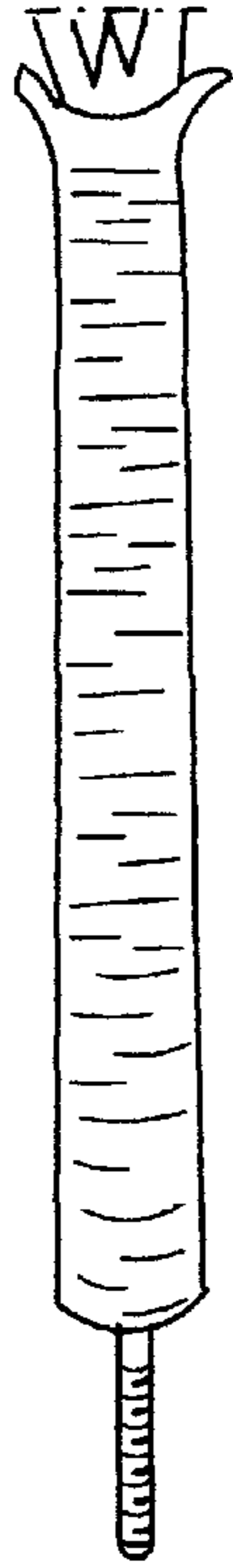

FIG. 18

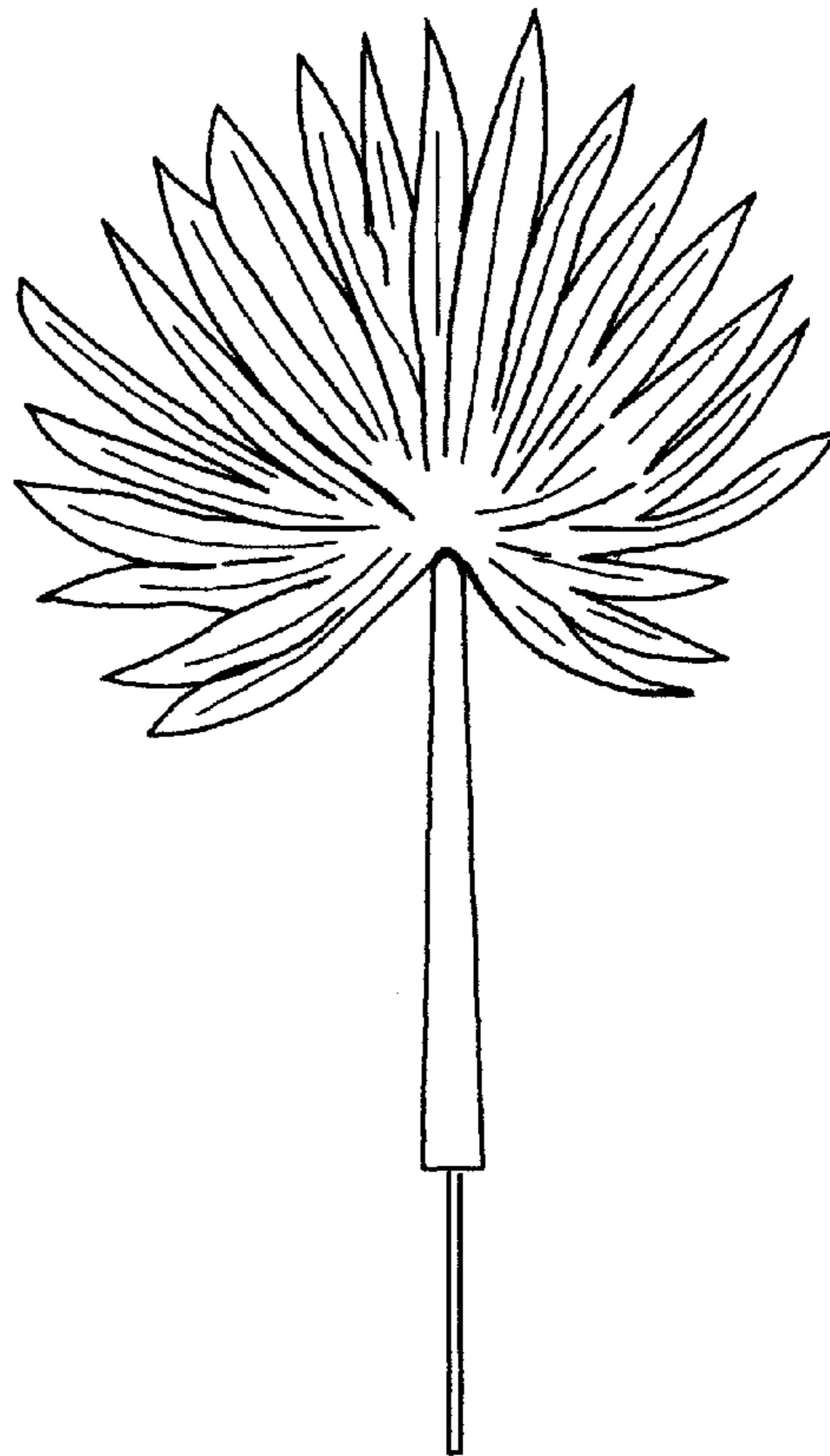

FIG. 19

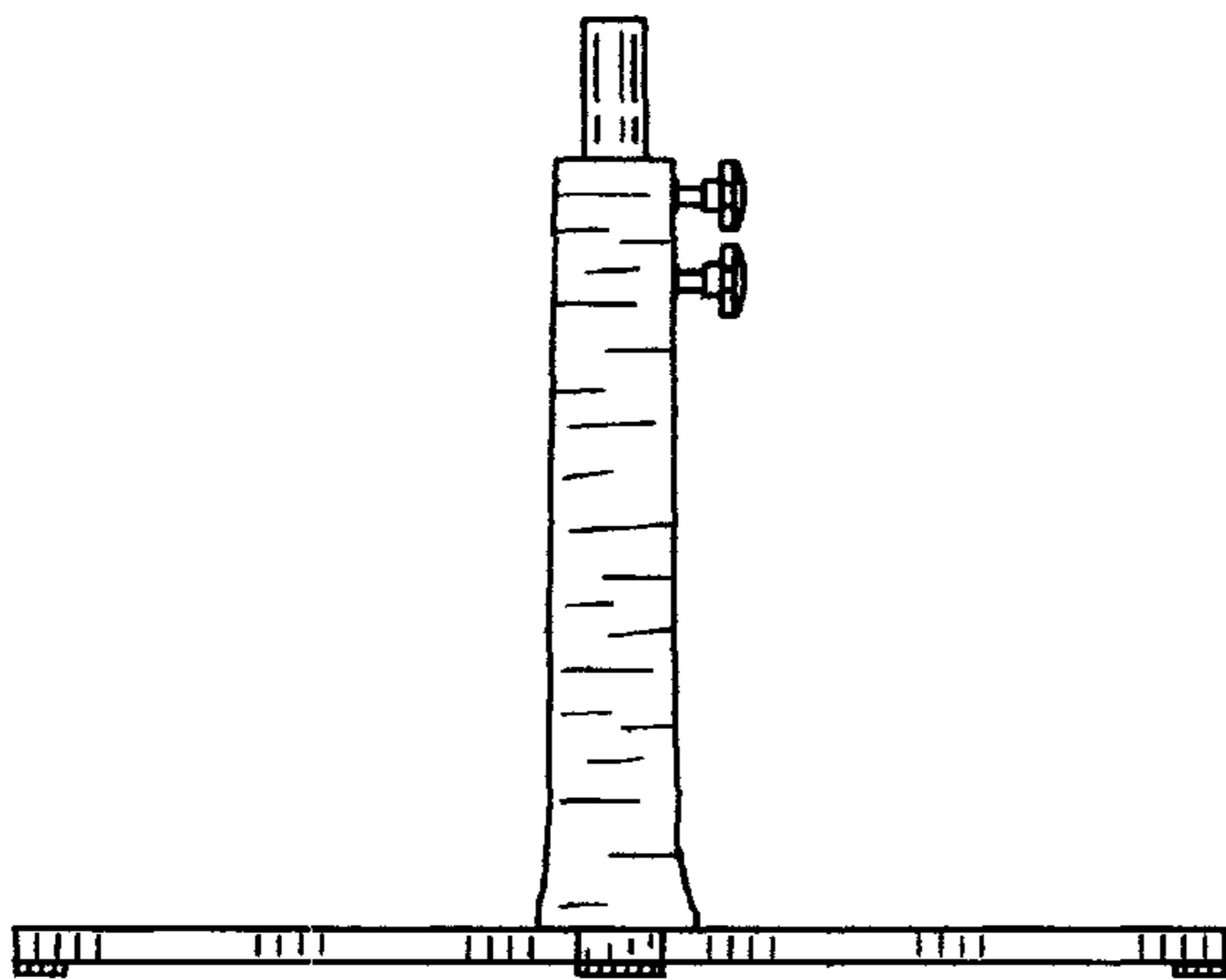

FIG. 20

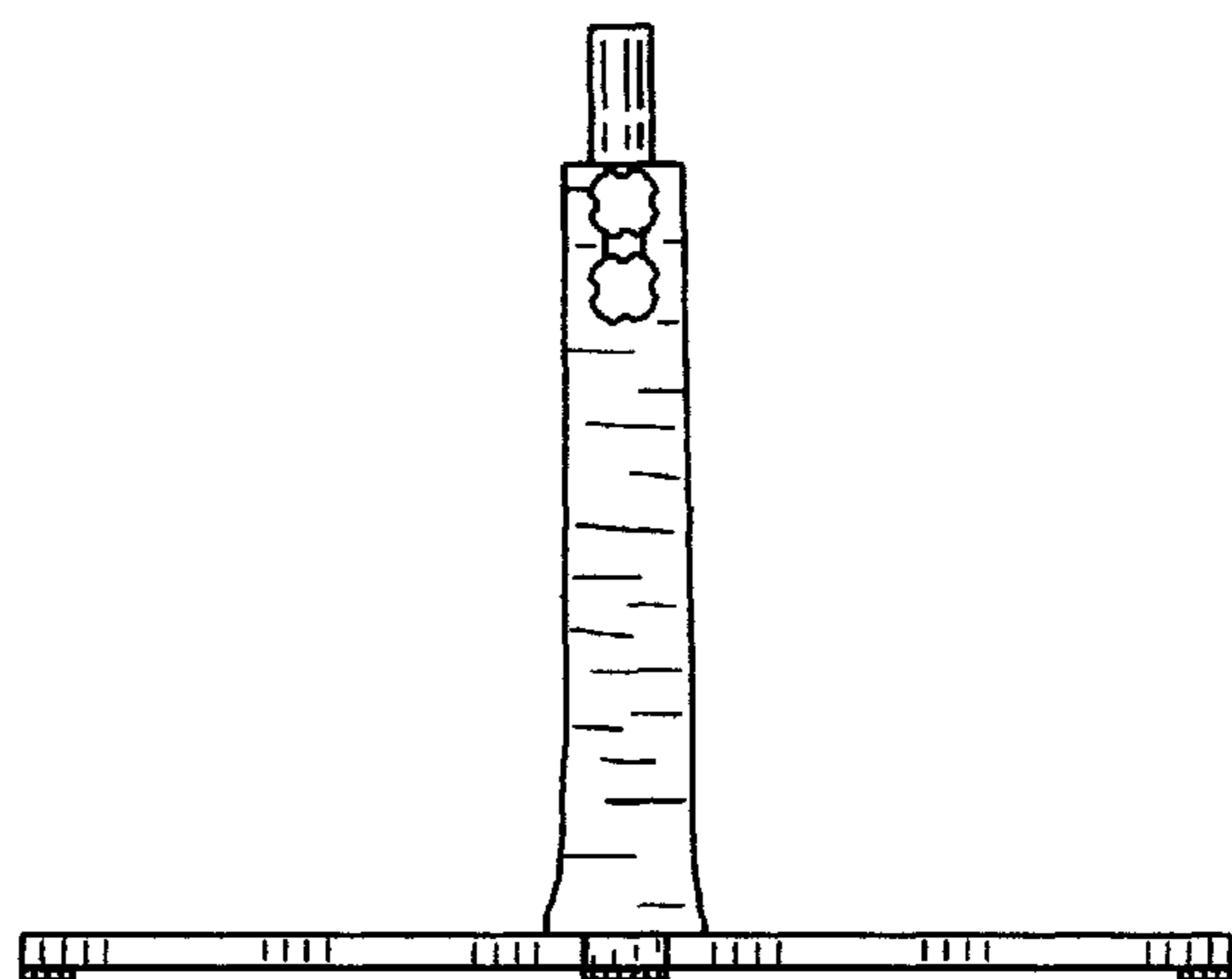

FIG. 21